

IBM EXP400 Storage Expansion Unit



User's Guide

IBM EXP400 Storage Expansion Unit



User's Guide

Note: Before using this information and the product it supports, read the general information in Appendix B, "Notices", on page 33.

First Edition (September 2003)

© Copyright International Business Machines Corporation 2003. All rights reserved.

US Government Users Restricted Rights – Use, duplication or disclosure restricted by GSA ADP Schedule Contract with IBM Corp.

Contents

Safety	v
Chapter 1. Introducing the IBM EXP400 Storage Expansion Unit	1
Related publications	1
Notices and statements used in this publication	2
Features and operating specifications	2
What your expansion unit offers	4
Expansion unit bays	5
Hot-swap hard disk drive bays.	5
Bridge card bay	5
Hot-swap ESM and power supply bays	6
Expansion unit controls, LEDs, components, connectors	6
Front view	6
Rear view: ac power supply with fan units	8
Rear view: ESMs	9
Power features	10
Turning on the expansion unit	10
Turning off the expansion unit	10
Turning off the expansion unit in an emergency	11
Turning on the expansion unit after an emergency	12
System-management software support	12
Chapter 2. ESM configuration switches	13
Chapter 3. Installing and replacing components	17
Installation guidelines	17
System reliability guidelines	17
Handling static-sensitive devices	17
Working with hot-swap hard disk drives	18
Replacing a hot-swap hard disk drive	19
Replacing a bridge card	20
Replacing an ESM	21
Replacing a hot-swap power supply with fan unit	22
Chapter 4. Information for the -48 volt dc power model.	25
Connecting the power supply to a power-distribution unit	26
Disconnecting and removing the dc power supply	27
Installing the dc power supply	28
Chapter 5. Solving problems	29
Appendix A. Getting help and technical assistance	31
Before you call	31
Using the documentation	31
Getting help and information from the World Wide Web	31
Software service and support	32
Hardware service and support	32
Appendix B. Notices	33
Edition notice	33
Trademarks	34
Important notes.	34
Product recycling and disposal	35

Electronic emission notices	35
Federal Communications Commission (FCC) statement	35
Industry Canada Class A emission compliance statement	35
Australia and New Zealand Class A statement	36
United Kingdom telecommunications safety requirement.	36
European Union EMC Directive conformance statement.	36
Taiwanese Class A warning statement	36
Chinese Class A warning statement	37
Japanese Voluntary Control Council for Interference (VCCI) statement	37
Power cords	37
Index	41

Safety

Before installing this product, read the Safety Information.

قبل تركيب هذا المنتج، يجب قراءة الملاحظات الأمنية

Antes de instalar este produto, leia as Informações de Segurança.

在安装本产品之前，请仔细阅读 **Safety Information** (安全信息)。

安裝本產品之前，請先閱讀「安全資訊」。

Prije instalacije ovog produkta obavezno pročitajte Sigurnosne Upute.

Před instalací tohoto produktu si přečtěte příručku bezpečnostních instrukcí.

Læs sikkerhedsforskrifterne, før du installerer dette produkt.

Lees voordat u dit product installeert eerst de veiligheidsvoorschriften.

Ennen kuin asennat tämän tuotteen, lue turvaohjeet kohdasta Safety Information.

Avant d'installer ce produit, lisez les consignes de sécurité.

Vor der Installation dieses Produkts die Sicherheitshinweise lesen.

Πριν εγκαταστήσετε το προϊόν αυτό, διαβάστε τις πληροφορίες ασφάλειας (safety information).

לפני שתתקינו מוצר זה, קראו את הוראות הבטיחות.

A termék telepítése előtt olvassa el a Biztonsági előírásokat!

Prima di installare questo prodotto, leggere le Informazioni sulla Sicurezza.

製品の設置の前に、安全情報をお読みください。

본 제품을 설치하기 전에 안전 정보를 읽으십시오.

Пред да се инсталира овој продукт, прочитајте информацијата за безбедност.

Les sikkerhetsinformasjonen (Safety Information) før du installerer dette produktet.

Przed zainstalowaniem tego produktu, należy zapoznać się z książką "Informacje dotyczące bezpieczeństwa" (Safety Information).

Antes de instalar este produto, leia as Informações sobre Segurança.

Перед установкой продукта прочтите инструкции по технике безопасности.

Pred inštaláciou tohto zariadenia si pečítajte Bezpečnostné predpisy.

Pred namestitvijo tega proizvoda preberite Varnostne informacije.

Antes de instalar este producto, lea la información de seguridad.

Läs säkerhetsinformationen innan du installerar den här produkten.

Important:

All caution and danger statements in this documentation begin with a number. This number is used to cross reference an English caution or danger statement with translated versions of the caution or danger statement in the *IBM Safety Information* book.

For example, if a caution statement begins with a number 1, translations for that caution statement appear in the *IBM Safety Information* book under statement 1.

Be sure to read all caution and danger statements in this documentation before performing the instructions. Read any additional safety information that comes with your server or optional device before you install the device.

Statement 1:



DANGER

Electrical current from power, telephone, and communication cables is hazardous.

To avoid a shock hazard:

- **Do not connect or disconnect any cables or perform installation, maintenance, or reconfiguration of this product during an electrical storm.**
- **Connect all power cords to a properly wired and grounded electrical outlet.**
- **Connect to properly wired outlets any equipment that will be attached to this product.**
- **When possible, use one hand only to connect or disconnect signal cables.**
- **Never turn on any equipment when there is evidence of fire, water, or structural damage.**
- **Disconnect the attached power cords, telecommunications systems, networks, and modems before you open the device covers, unless instructed otherwise in the installation and configuration procedures.**
- **Connect and disconnect cables as described in the following table when installing, moving, or opening covers on this product or attached devices.**

To Connect:

1. Turn everything OFF.
2. First, attach all cables to devices.
3. Attach signal cables to connectors.
4. Attach power cords to outlet.
5. Turn device ON.

To Disconnect:

1. Turn everything OFF.
2. First, remove power cords from outlet.
3. Remove signal cables from connectors.
4. Remove all cables from devices.

Statement 4:



≥ 18 kg (39.7 lb)



≥ 32 kg (70.5 lb)



≥ 55 kg (121.2 lb)

CAUTION:

Use safe practices when lifting.

Statement 5:



CAUTION:

The power control button on the device and the power switch on the power supply do not turn off the electrical current supplied to the device. The device also might have more than one power cord. To remove all electrical current from the device, ensure that all power cords are disconnected from the power source.

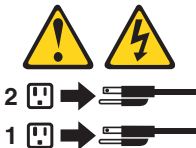

Statement 19:



CAUTION:

The power-control button on the device does not turn off the electrical current supplied to the device. The device also might have more than one connection to dc power. To remove all electrical current from the device, ensure that all connections to dc power are disconnected at the dc power input terminals.

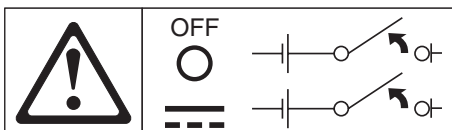

Statement 22:



CAUTION:

To reduce the risk of electric shock or energy hazards:

- This equipment must be installed by trained service personnel in a restricted-access location, as defined by the NEC and IEC 60950, Third Edition, The Standard for Safety of Information Technology Equipment.
- Connect the equipment to a reliably grounded safety extra low voltage (SELV) source. An SELV source is a secondary circuit that is designed so that normal and single fault conditions do not cause the voltages to exceed a safe level (60 V direct current).
- The branch circuit overcurrent protection must be rated at a minimum of 13 A to a maximum of 15 A.
- Use 16 American Wire Gauge (AWG) or 1.3 mm² copper conductor only, not exceeding 3 meters in length.
- Torque the wiring-terminal screws to 12 inch-pounds (1.4 newton-meters).
- Incorporate a readily available accessible and rated disconnect device in the field wiring.

WARNING: Handling the cord on this product or cords associated with accessories sold with this product, will expose you to lead, a chemical known to the State of California to cause cancer, and birth defects or other reproductive harm. ***Wash hands after handling.***

ADVERTENCIA: El contacto con el cable de este producto o con cables de accesorios que se venden junto con este producto, pueden exponerle al plomo, un elemento químico que en el estado de California de los Estados Unidos está considerado como un causante de cancer y de defectos congénitos, además de otros riesgos reproductivos. ***Lávese las manos después de usar el producto.***

Chapter 1. Introducing the IBM EXP400 Storage Expansion Unit

The IBM® EXP400 Storage Expansion Unit, referred to in this *User's Guide* as expansion unit, provides high-capacity, small computer system interface (SCSI) disk storage. It supports up to 14 Ultra320 SCSI hard disk drives on a single or dual bus. It delivers fast, high-volume data transfer, retrieval, and storage functions across multiple drives, to multiple hosts. The expansion unit is designed for continuous, reliable service; the modular, redundant disk drives, power supply with fan units, and SCSI Bus Expander and Enclosure Services Module (referred to in this book as ESM) use hot-swap technology for easy replacement without turning off the expansion unit. For more information, see “What your expansion unit offers” on page 4.

Expansion unit models 1RU and 1RX come with two 500-watt ac power supply with fan units, one ESM (the second ESM is optional), a filler panel to cover the empty ESM bay, and 14 drive filler panels. Expansion unit model 2RX comes with two -48 volt dc power supply with fan units, two ESMs, and 14 drive filler panels. The drive filler panels are replaced with hard disk drive options.

Your expansion unit comes with a limited warranty. For more information about the terms of your warranty, see the *Installation Guide*.

For service or assistance information, see Appendix A, “Getting help and technical assistance”, on page 31.

Related publications

This *User's Guide* provides general information about your expansion unit, including information about features and how to configure and use your expansion unit. This *User's Guide* also provides step-by-step instructions for replacing components and how to get help. In addition to this *User's Guide*, the following documentation comes with your expansion unit:

- *Installation Guide*

This printed publication contains instructions for setting up your expansion unit and basic instructions for installing some options.

- *Safety Information*

This publication is in Portable Document Format (PDF) on the IBM *Documentation CD*. It contains translated caution and danger statements. Each caution and danger statement that appears in the documentation has a number that you can use to locate the corresponding statement in your language in the *Safety Information* book.

- *Rack Installation Instructions*

This printed publication contains instructions for installing your expansion unit in a rack.

- *Hardware Maintenance Manual and Troubleshooting Guide*

This publication is in PDF on the IBM Support Web site, <http://www.ibm.com/pc/support/>. It contains information to help you solve problems yourself, and it contains information for service technicians.

- *Rack-to-Tower Conversion Kit Installation Instructions*

This printed publication comes with the Rack-to-Tower Conversion kit and contains detailed instructions for converting a rack-model expansion unit to a tower-model expansion unit.

Your expansion unit documentation might be updated occasionally to include information about new features, a translated version of the documentation might be available in your language, or technical updates might be available to provide additional information that is not included in your expansion unit documentation. These updates are available from the IBM Web site. Complete the following steps to check for updated documentation and technical updates:

1. Go to <http://www.ibm.com/pc/support/>.
2. In the **Learn** section, click **Online publications**.
3. On the “Online publications” page, in the **Brand** field, select **Servers**.
4. In the **Family** field, select **Rack/Storage Enclosures**.
5. Click **Display documents**.

Notices and statements used in this publication

The caution and danger statements that appear in this publication are also in the multilingual *Safety Information* publication, which is on the IBM *Documentation CD*. Each statement is numbered for reference to the corresponding statement in the *Safety Information* publication.

The following notices and statements are used in this publication:

- **Notes:** These notices provide important tips, guidance, or advice.
- **Important:** These notices provide information or advice that might help you avoid inconvenient or problem situations.
- **Attention:** These notices indicate potential damage to programs, devices, or data. An attention notice is placed just before the instruction or situation in which damage could occur.
- **Caution:** These statements indicate situations that can be potentially hazardous to you. A caution statement is placed just before the description of a potentially hazardous procedure step or situation.
- **Danger:** These statements indicate situations that can be potentially lethal or extremely hazardous to you. A danger statement is placed just before the description of a potentially lethal or extremely hazardous procedure step or situation.

Features and operating specifications

Table 1 on page 3 contains a summary of the features and operating specifications for your expansion unit. Depending on your expansion unit model, some features might not be available, or some specifications might not apply.

Table 1. Features and operating specifications

<p>General:</p> <ul style="list-style-type: none"> • Modular components <ul style="list-style-type: none"> – High-capacity disk drives – SCSI Bus Expander and Enclosure Services Module (ESM) – Power supplies with built-in fan units • Technology <ul style="list-style-type: none"> – Supports disk array technology – Supports clustering – SCSI (Ultra320) host interface, redundant data storage, power and cooling system, and ESMs – Hot-swap technology for hard disk drives, power supply with fan units, and ESMs • User interface <ul style="list-style-type: none"> – Built-in power, activity, and fault indicators, identification labeling on CRUs, rear indicator lights, switches, and connectors – Easy-to-replace drives, power supplies with built-in fan units, and ESMs <p>Hard disk drive storage:</p> <ul style="list-style-type: none"> • Current capabilities: <ul style="list-style-type: none"> – Maximum hard disk drives per expansion unit: 14 – Hard disk drives per SCSI bus segment: 7 – SCSI buses per unit: 2 – SCSI buses can be configured as one continuous SCSI bus. <p>ESMs:</p> <ul style="list-style-type: none"> • Technology and interfaces: <ul style="list-style-type: none"> – SCSI: Ultra320 – SCSI bus interface: Two 68-pin, Very High Density Connector Interface (VHDCI) connectors for SCSI bus cables 	<p>Acoustical noise emissions: For open bay (no drives installed) and maximum system configurations (14 hard disk drives installed).</p> <ul style="list-style-type: none"> • Sound power (idling): <ul style="list-style-type: none"> – 5.5 bels (open bay) – 5.7 bels (typical) • Sound power (operating): <ul style="list-style-type: none"> – 6.0 bels (open bay) – 6.5 bels (typical) • Sound pressure (idling): <ul style="list-style-type: none"> – 44 dBA (open bay) – 47 dBA (typical) • Sound pressure (operating): <ul style="list-style-type: none"> – 44 dBA (open bay) – 54 dBA (typical) <p>AC power supply with built-in fan:</p> <ul style="list-style-type: none"> • Expansion unit model 1RU or 1RX comes with two hot-swap 500 watt (115 - 230 V ac) power supply with fan units. • The two power supplies provide redundant power to the expansion unit. <p>-48 volt dc power supply:</p> <p>At a nominal voltage of -48 volt dc, the expansion unit draws approximately 5 amperes.</p> <p>Size:</p> <ul style="list-style-type: none"> • Height: 12.8 cm (5.0 in.) • Depth: 54.0 cm (21.8 in.) • Width: 44.7 cm (17.6 in.) • Weight: approximately 24.3 kg (53.6 lb) for a standard unit. When fully configured 37.3 kg (82 lb) <p>Environment:</p> <ul style="list-style-type: none"> • Air temperature: <ul style="list-style-type: none"> – Expansion unit on: 10° to 40°C (50.0° to 104°F); altitude: 30.5 (100 ft) below to 3000 m (9840 ft) above sea level; temperature change: 10°C to (18°F) per hour – Expansion unit off: 10° to 50°C (14.0° to 120.0°F); maximum altitude: 3000 m (9840 ft); temperature change: 15°C (27.0°F) per hour 	<p>Environment cont.</p> <ul style="list-style-type: none"> • Humidity: <ul style="list-style-type: none"> – Expansion unit on: 20% to 80% – Expansion unit off: 10% to 90% – Maximum dew point: 26°C (79°F) – Maximum humidity gradient: 10% per hour <p>Heat output:</p> <p>Approximate heat output in British thermal units (Btu) per hour:</p> <ul style="list-style-type: none"> • Minimum configuration: 82.4 Btu (282 watts) • Maximum configuration: 91.0 Btu (311 watts) <p>Electrical input:</p> <ul style="list-style-type: none"> • Sine-wave input (50-60 Hz) required • Input voltage low range: <ul style="list-style-type: none"> – Minimum: 90 V ac – Maximum: 136 V ac • Input voltage high range: <ul style="list-style-type: none"> – Minimum: 198 V ac – Maximum: 264 V ac • Input kilovolt-amperes (kVA), approximately: <ul style="list-style-type: none"> – Minimum: 0.06 kVA – Maximum: 0.45 kVA <p>Notes:</p> <ol style="list-style-type: none"> 1. Power consumption and heat output vary depending on the number and type of optional features installed and the power-management optional features in use. 2. These levels were measured in controlled acoustical environments according to the procedures specified by the American National Standards Institute (ANSI) S12.10 and ISO 7779 and are reported in accordance with ISO 9296. Actual sound-pressure levels in a given location might exceed the average values stated because of room reflections and other nearby noise sources. The declared sound-power levels indicate an upper limit, below which a large number of computers will operate.
--	--	---

What your expansion unit offers

The expansion unit provides several features for easy operation, including:

- **Customer replaceable units (CRUs)**

The CRUs in your expansion unit are: Ultra320 hard disk drives, ESMs, and power supply with fan units.

- **Fault indicators**

All CRUs have fault or status light emitting diodes (LEDs) to indicate hardware failures.

- **Switch selectable Box ID and user configuration settings**

The ESM contains five sets of configuration switches that you can set according to your configuration. For detailed information about these switches and their settings, see Chapter 2, “ESM configuration switches”, on page 13.

- **Redundant cooling and power capabilities**

Expansion unit models 1RU and 1RX use a dual ac input power system. This means both power switches must be turned on for proper redundant operation. The redundant cooling of the fans in your expansion unit enables continued operation if one fan fails. Your expansion unit comes with two 500-watt hot-swap power supply with fan units, which provide redundant power for many expansion unit configurations. If the average load on your expansion unit is less than 500 watts and a problem occurs with one of the power supplies, the other power supply can meet the power requirements.

Expansion unit model 2RX uses a dual dc input power system. For detailed information about working with the dual dc input power system, see Chapter 4, “Information for the -48 volt dc power model”, on page 25.

- **ServeRAID™ support**

Your expansion unit supports servers with ServeRAID adapters to create redundant array of independent disks (RAID) configurations.

- **Clustering support**

Twin-tailed clustering support is a feature of the expansion unit. Clustering is a way to share SCSI buses and hard disk drives between two SCSI controllers to provide redundancy of SCSI controllers and servers. This redundancy is important if one of the controlling servers fails. If a hardware component fails after clustering is set up, another server will take ownership of the hard disk drives.

With twin-tailed clustering, you can connect two IBM ServeRAID controllers to an expansion unit. In the twin-tailed clustering environment, you can use dual-host controllers cabled separately to the expansion unit; however, only a single bus of 13 drives is supported. Each SCSI device on a SCSI bus must have a unique ID.

Service tip: If you use IBM ServeRAID controllers in a cluster configuration, the termination-power LED on the back of the expansion unit is useful. The ServeRAID controller provides the signal for termination power. If the termination power LED is not lit, it indicates that a particular expansion unit is not attached to a controller that is turned on. Make a note of which expansion unit is attached to which server before the hardware is serviced.

Clustering requires additional hardware and specialized software. For more information, go to <http://www.ibm.com/pc/ww/eserver/xseries/clustering/>.

Expansion unit bays

The following sections describe the hot-swap components of the expansion unit and the bridge card bay.

With the hot-swap features of the expansion unit, you can remove and replace a hard disk drive, power supply with fan unit, and ESM without turning off the expansion unit. You can maintain the availability of your expansion unit while a hot-swap component is removed, installed, or replaced.

Hot-swap hard disk drive bays

The following illustration shows the location of the hot-swap hard disk drive bays that are accessible from the front of your expansion unit. The expansion unit supports up to 14 IBM Ultra320 SCSI hard disk drives. These drives come preassembled in a drive tray. You install the hard disk drives in the 14 drive bays on the front of the expansion unit.

In the following illustration, seven of the 14 hard disk drive bays contain hard disk drives, and seven bays contain filler panels. To maintain proper cooling within your expansion unit, always keep a filler panel in each drive bay that does not contain a hard disk drive. For information about installing and replacing drives, see “Working with hot-swap hard disk drives” on page 18.

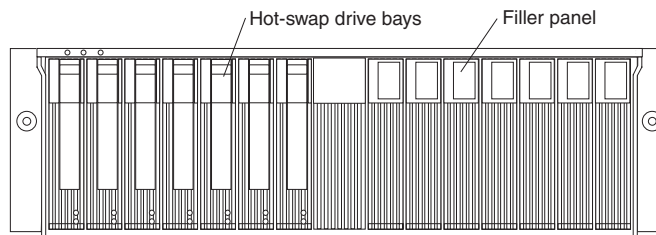

Attention: Never hot-swap a hard disk drive when its green activity LED is flashing. Hot-swap a hard disk drive only when its amber status LED is lit (not flashing) or when the drive is inactive with the green activity LED off (not flashing). Use the ServeRAID system-management software to set the hard disk drive state to “defunct” and then you can hot-swap it.

Bridge card bay

The following illustration shows the location of the bridge card bay. This bay is accessible from the front of the expansion unit. You can replace the bridge card, but you must turn off the expansion unit before doing so. For more information about replacing a bridge card, see “Replacing a bridge card” on page 20.

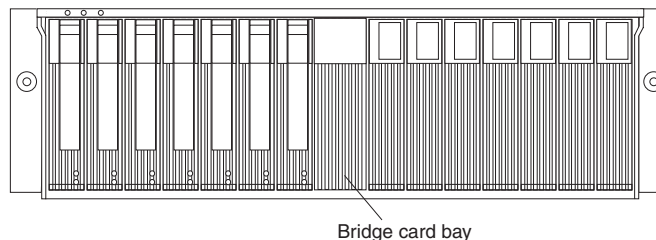

Hot-swap ESM and power supply bays

The following illustration shows the location of the hot-swap ESM bays (for the hot-swap ESMs) and the power supply bays (for the hot-swap power supply with fan units).

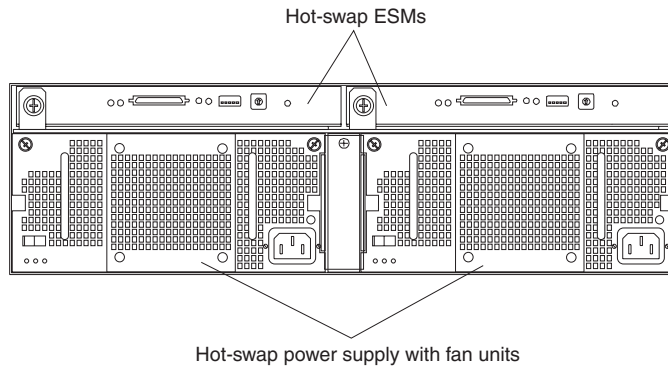

Hot-swap ESM bays

The expansion unit comes with two ESM bays for the hot-swap ESMs. ESMs provide a SCSI interface to the hard disk drives and monitor the overall status of the expansion unit. An ESM has five sets of switches for user configuration. For more information about replacing an ESM, see “Replacing an ESM” on page 21. For more information about ESM switches, see Chapter 2, “ESM configuration switches”, on page 13.

Hot-swap power supply with fan unit bays

Expansion unit models 1RU and 1RX come with two 500 watt hot-swap and redundant power supply with fan units. The power supplies are redundant in that a single power supply can provide adequate power and cooling for the entire expansion unit. A single power supply can support up to 14 hard disk drives; however, both power supplies must be installed, even if one power supply is not operational. For more information about working with hot-swap power supplies, see “Replacing a hot-swap power supply with fan unit” on page 22.

Expansion unit model 2RX comes with two -48 volt dc power supply with fan units. For information about installing or replacing the -48 volt power supplies, see Chapter 4, “Information for the -48 volt dc power model”, on page 25.

Expansion unit controls, LEDs, components, connectors

The primary controls of the expansion unit are located on the front of the unit. The user controls of the expansion unit are located on the back of the unit. Two hot-swap power supply with fan units and two ESMs are accessible from the back of the expansion unit. These components contain several user indicators and connectors.

Front view

The primary controls on the front of the expansion unit are shown in the following illustration and are described in this section.

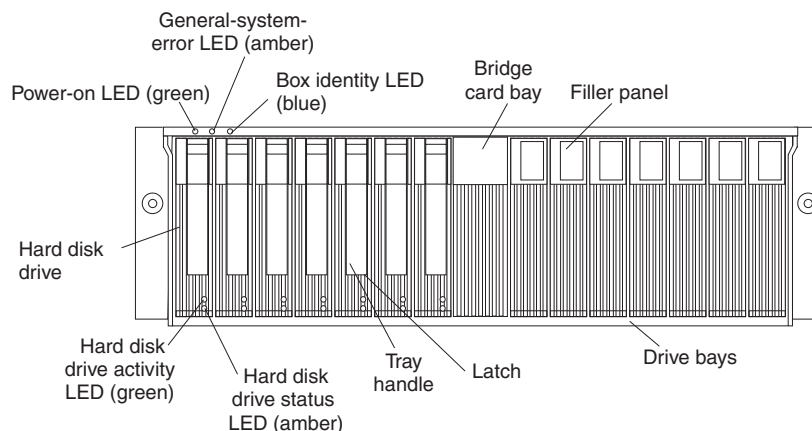

Power-on LED (green)

This green LED is lit when the power supply is turned on and is supplying both 5 volt and 12 volt dc power to the expansion unit.

General-system-error LED (amber)

When lit, this amber LED indicates that the unit has a fault, such as in a power supply, ESM, or hard disk drive.

Box identity (blue)

The box identity LED is used to identify the expansion unit. When this blue LED is lit, the system-management software on the server connected to the expansion unit has identified this expansion unit.

Bridge card bay

The bridge card is located in the center of the front panel between bay 7 and bay 8.

Filler panel

Expansion units come with drive filler panels in the unused drive bays. Before installing new hard disk drives, you must remove the filler panels and save them for later use. Each of the 14 bays must contain either a filler panel or a hard disk drive.

Drive bays

There are 14 drive bays that contain either a hard disk drive or a filler panel.

Latch This multipurpose blue latch releases or locks the hard disk drive in place.

Tray handle

You can use this multipurpose handle to insert or remove a hard disk drive.

Status LED (amber)

Each hard disk drive has a status LED. When lit continuously, this amber LED indicates a drive failure. When flashing, this amber LED indicates that a drive Identify or Rebuild is in progress.

Activity LED (green)

Each hard disk drive has an activity LED. When flashing, this green LED indicates drive activity.

Hard disk drive

You can install up to 14 hot-swap hard disk drives in the expansion unit. Each drive contains an Ultra320 hard disk drive and tray.

Rear view: ac power supply with fan units

Two hot-swap power supply with fan units are accessible from the back of the expansion unit. These components at the back of the expansion unit contain several user controls, LEDs, and connectors as shown in the following illustration.

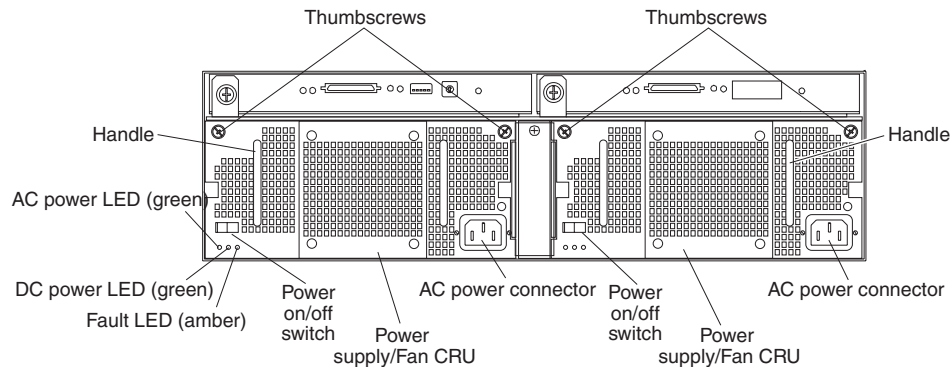

Thumbscrews

Loosen the thumbscrews to remove or install a power supply with fan unit.

AC power connector

The power cord for the power supply with fan unit connects here.

Power supply with fan unit

The two hot-swap power supply with fan units are located on the back of the expansion unit.

Attention: The expansion unit comes with two power supply with fan units installed. When one power supply fails, the power-supply unit must be replaced to reestablish redundancy. When replacing the failed unit with the new power supply unit, ensure that this operation is performed in less than 10 minutes to prevent overheating.

The fan that is visible from the rear of the power supply is an auxiliary fan that is normally off. This fan turns on only when the main fan within the power supply fails.

Power on/off switch

Use this switch to turn the power supply on and off.

Fault LED (amber)

When lit continuously, this amber fault LED indicates a power supply failure or that a redundant power supply is not turned on. This LED also flashes when the built-in fan fails.

DC power LED (green)

This green LED is lit when the expansion unit is turned on and is supplying both 5 volt and 12 volt dc power to the expansion unit.

AC power LED (green)

This green LED is lit when the power supply is receiving ac power.

Handles

The two handles are used for installing and removing the power supply with fan unit.

Rear view: ESMs

The ESMs are accessible from the back of the expansion unit. These components contains user controls, LEDs, switches, and connectors as shown in the following illustration.

Note: The ESM on the right side is optional on expansion unit models 1RU and 1RX.

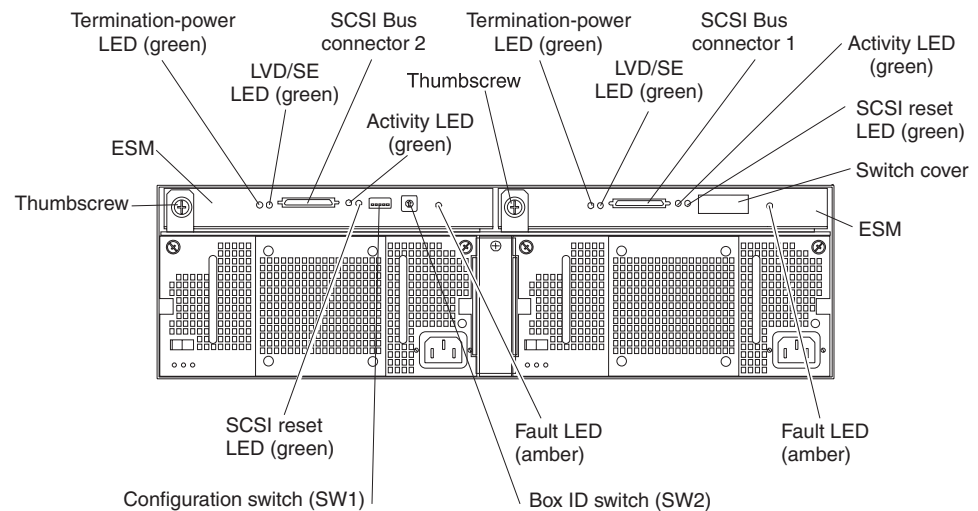

ESM Each ESM contain SCSI controls, LEDs, and connectors.

Fault LED (amber)

When lit, this amber LED indicates an ESM failure.

SCSI reset LED

When lit, this green LED indicates a SCSI bus reset.

Thumbscrews

Each ESM has a thumbscrew on the left side of the module. Use the thumbscrew and lever to remove and insert the ESM.

Termination-power LED (green)

When lit, this green LED indicates that termination power is present. When a termination-power LED is lit, it indicates that the other end of the SCSI bus connector is connected to a powered-on controller. Each external bus has a separate termination-power LED.

LVD/SE LED (green)

When lit, this green LED indicates that the external host bus is in low voltage differential (LVD) mode. When this LED is off, it indicates that the external host bus is in single-ended (SE) mode. Each external bus has a separate LVD/SE LED. Only LVD host bus controllers are supported.

SCSI bus connector

The 68-pin Very High Density Connector Interface (VHDCI) connectors are for connecting your SCSI cables to SCSI bus 1 and SCSI bus 2.

Activity LED (green)

When lit, this green LED indicates there is activity on the external SCSI bus. Both external buses have a separate activity LED.

Configuration switch SW1

Configuration switch SW1 is a 5-position switch that is mounted on the ESM and is accessible from the rear of the expansion unit.

Box ID switch SW2

Box ID switch SW2 is a 10-position rotary switch that sets the expansion unit ID using values 0 through 9. System-management software, such as IBM Director or ServeRAID Manager, uses this ID when it provides data and alerts for the expansion unit.

Power features

This section contains instructions for turning the expansion unit on and off under normal and emergency circumstances.

Turning on the expansion unit

If you are turning on the expansion unit after an emergency shutdown or power outage, see “Turning on the expansion unit after an emergency” on page 12.

Complete the following steps to turn on the power for the initial startup of the expansion unit.

1. Verify that:
 - a. All cables are properly attached.
 - b. Both power cords are plugged into the back of the expansion unit and into properly grounded electrical outlets.
 - c. All hard disk drives are locked securely in place.
 - d. The configuration switches are set correctly. See Chapter 2, “ESM configuration switches”, on page 13.
2. Check the system documentation for all the hardware devices you intend to turn on and determine the proper power-on sequence.

Note: Be sure to turn on the expansion unit before or at the same time as you turn on the server.

3. Turn on each device, based on the power-on sequence that is described in the documentation that comes with the device.
4. Turn on both power supplies on the back of the expansion unit.

The expansion unit might take a few seconds to turn on. During this time, you might see the fault (amber) and the power (green) LEDs on the expansion unit turn on and off intermittently. When the power-on sequence is complete, only the power (green) LEDs on the front and back should remain on. If one or more fault (amber) LEDs remain lit, refer to Chapter 5, “Solving problems”, on page 29.

Turning off the expansion unit

Attention: Except in an emergency situation, never turn off the power if any fault LEDs are lit on the expansion unit. Correct the fault before you attempt to turn off the power, using the proper troubleshooting or servicing procedure. This will ensure that the expansion unit will turn on correctly later. See Chapter 5, “Solving problems”, on page 29.

Statement 5:



CAUTION:

The power control button on the device and the power switch on the power supply do not turn off the electrical current supplied to the device. The device also might have more than one power cord. To remove all electrical current from the device, ensure that all power cords are disconnected from the power source.

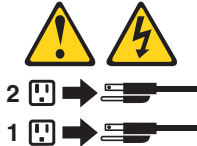

The expansion unit is designed to run continuously, 24 hours a day. Turn off the power only when at least one of the following is true:

- Instructions in a hardware or software procedure require you to turn off the power.
- A service technician tells you to turn off the power.
- A power outage or emergency situation occurs. See “Turning off the expansion unit in an emergency”.

Complete the following steps to turn off the expansion unit:

1. Close all active operating system windows and programs.
2. Power down the server attached to the expansion unit.
3. Make sure that all amber status and fault LEDs are off. If any status or fault LEDs are lit (on hard disk drives, power supplies, or ESMs), identify or correct the problem before you turn off the power. For more information, see Chapter 5, “Solving problems”, on page 29.
4. Turn off both power supplies.

Turning off the expansion unit in an emergency

Attention: Emergency situations might include fire, flood, extreme weather conditions, or other hazardous circumstances. If a power outage or emergency situation occurs, always turn off all power switches on all computing equipment. This will help safeguard your equipment from potential damage due to electrical surges when power is restored. If the expansion unit loses power unexpectedly, it might be due to a hardware failure in the power system or midplane, see Chapter 5, “Solving problems”, on page 29.

Complete the following steps to turn off the expansion unit during an emergency situation:

1. Close all active operating system windows and programs.
2. Power down the server attached to the expansion unit.
3. If you have time, stop all activity and check the LEDs (front and back). Make note of any status or fault LEDs that are lit so that you can correct the problem when you turn on the power again.
4. Turn off all expansion unit power supplies; then, unplug the power cables from the expansion unit.

Turning on the expansion unit after an emergency

Complete the following steps to restart the expansion unit if you turned off the power supplies during an emergency shutdown, or if a power failure or a power outage occurred:

1. After the emergency situation is over or power is restored, check the expansion unit for damage. If there is no visible damage, continue with step 2; otherwise, have your unit serviced.
2. After you check for damage, plug in the expansion-unit power cables and turn on the power switches.
3. Check the system documentation for the hardware devices you intend to turn on, and determine the proper power-on sequence.

Note: Be sure to turn on the expansion unit before or at the same time you turn on the server.

4. Turn on each device, based on the power-on sequence that is described in the documentation that comes with the device.
5. Turn on both power supplies on the back of the expansion unit.
6. Only the power (green) LEDs on the front and back should be on. If one or more of the fault (amber) LEDs are on, see Chapter 5, “Solving problems”, on page 29 for instructions.
7. Use your installed software application as appropriate to check the status of the expansion unit.

System-management software support

The expansion unit provides software alert functions through the system monitor functions provided in the IBM Director and IBM ServeRAID software.

The following alerts are supported:

- Hard disk drive disabled
- Power supply failure
- Fan failure
- Expansion unit exceeds normal operating temperature

You must use IBM ServeRAID version 6.10.25 or later for your ServeRAID controller to report status and alerts properly. To download the latest ServeRAID software, go to <http://www.ibm.com/pc/support/>.

For up-to-date information about IBM Director software support available for your expansion unit, go to http://www.ibm.com/pc/ww/eserver/xseries/systems_management/index.html.

Chapter 2. ESM configuration switches

This chapter provides general information about ESM functionality as it relates to ESM configuration switch settings. The ESM configuration switches control how power is supplied to the expansion unit and what expansion unit services are enabled (for example, switching between a rack configuration and a tower configuration or switching between a single bus and a dual-bus configuration.) In a dual-bus configuration, each bus uses seven drives. A single-bus configuration uses all 14 drives.

An ESM contains five sets of configuration switches, shown in the following illustration.

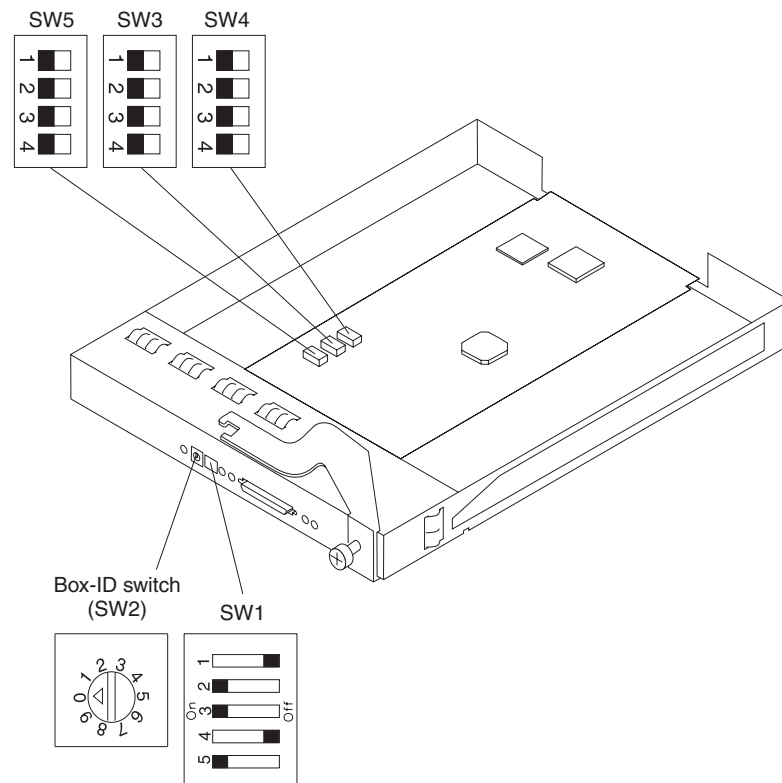

Configuration switches are summarized in Table 2 and described in this section.

Table 2. Factory default configuration switch settings

Switch location	Position	Description	Factory default switch setting
Configuration switch SW1	1	Reserved	Off
	2	Reserved	On
	3	Reserved	On
	4	Reserved	Off
	5	Remote power control disable	On
Box ID switch SW2	Rotary	Expansion unit ID	0
Configuration switch SW3	1	SCSI ID configuration 1	Off

Table 2. Factory default configuration switch settings (continued)

Switch location	Position	Description	Factory default switch setting
	2	SCSI ID configuration 2	Off
	3	SCSI ID configuration 3	Off
	4	Reserved	Off
Configuration switch SW4	1	SCSI-bus split control	Off
	2	Rack and tower LED	Off
	3	Reserved	Off
	4	Reserved	Off
Configuration switch SW5	1	Reserved	Off
	2	Reserved	Off
	3	Reserved	Off
	4	Reserved	Off

Configuration switch SW1 settings

Configuration switch SW1 is a five-position switch that is mounted on the ESM and is accessible from the rear of the expansion unit. The five switch positions are set as follows:

- Switch positions 1 through 4 - Reserved
- Switch position 5 - Remote power control disable

When switch position 5 is set to Off, the ESM will enable the power supplies when the termination power (TERMPWR) is active in any external SCSI port. This means that the expansion unit will be powered on and off automatically when the host server is powered on and off or when TERMPWR is disabled. When switch position 5 is set to On (the default setting), power on and off is not controlled by the TERMPWR signal, but by the power on/off switches on the power supplies.

Box ID switch SW2

Box ID switch SW2 is a 10-position rotary switch that sets the expansion unit ID using values 0 through 9. System-management software, such as IBM Director or IBM ServeRAID Manager, uses this ID when it provides data and alerts for the expansion unit.

Configuration switch SW3 — SCSI ID configuration switch

Configuration switch SW3 defines the SCSI bus ID configurations. The user should prevent a SCSI ID conflict in a specific bus mode. SCSI bus mode is controlled by configuration switch SW4.

There are two SCSI buses (bus 1 and bus 2) in the expansion unit. Each bus uses seven SCSI ID numbers. Each hard disk drive within the expansion unit has a unique SCSI bus and ID assignment, based on its physical location in the expansion unit and the setting of configuration switch SW3. This prevents a SCSI ID conflict in a specific bus mode.

The switch positions configure the SCSI ID assignment. Switch positions 1, 2, and 3 are set to Off for rack enclosures. Rack enclosure SCSI IDs are identified from left to right. The SCSI addresses are 0, 1, 2, 3, 4, 5, 6, 8, 9, 10, 11, 12, 13, 14.

Switch positions 1, 2, and 3 are set to On for a tower enclosures. The enclosure unit is rotated counter-clockwise 90 degrees to be converted to a tower unit. In this case, the SCSI addresses are reversed and they are 0, 1, 2, 3, 4, 5, 6, 8, 9, 10, 11, 12, 13, 14 from top to bottom. All other switch settings are reserved. Numbered stickers for the front of the drives are provided so you can label the drives with the SCSI IDs.

- **Switch position 1 - SCSI ID configuration 1**
This switch position (default is Off) is used to configure SCSI ID assignment with a combination of SCSI ID switch positions 2 and 3.
- **Switch position 2 - SCSI ID configuration 2**
This switch position (default is Off) is used to configure SCSI ID assignment with a combination of SCSI ID switch positions 1 and 3.
- **Switch position 3 - SCSI ID configuration 3**
This switch position (default is Off) is used to configure SCSI ID assignment with a combination of SCSI ID switch positions 1 and 2.
- **Switch position 4 - Reserved**
This switch position is reserved and set to Off (the default).

Table 3. SCSI ID configuration matrix

SW position			Bus Config	L-segment							R-segment						
1	2	3		Slot 1	Slot 2	Slot 3	Slot 4	Slot 5	Slot 6	Slot 7	Slot 8	Slot 9	Slot 10	Slot 11	Slot 12	Slot 13	Slot 14
Off	Off	Off	Rack	0	1	2	3	4	5	6	8	9	10	11	12	13	14
On	On	On	Tower	14	13	12	11	10	9	8	6	5	4	3	2	1	0

Configuration switch SW4

Configuration switch SW4 controls the SCSI bus configuration. When switch position 1 is set to Off (default is Off), the expansion unit configuration is set as a single SCSI bus mode. When switch position 1 is set to On, the expansion unit configuration is set as a dual SCSI bus (split bus) mode.

- **Switch position 1 - SCSI-bus split control**
This switch position controls the SCSI bus mode. When the switch position is set to Off (default is Off), the expansion unit is configured as a single SCSI bus. When this switch position is set to On, the expansion unit is configured as a dual or split SCSI bus.
- **Switch position 2 - Rack-to-tower LED mode**
Set switch position 2 to Off (default is Off) for rack enclosures and to On for tower enclosures. These settings control the power and fault LEDs on the midplane, which are exchanged from one orientation to the other. In a tower enclosure, the top LED is green and in a rack enclosure, the left side LED is green.

Note: If you are installing the expansion unit in a tower enclosure, see the *Rack-to-Tower Conversion Kit Installation Instructions* for configuration switch settings and labeling information.

- **Switch position 3 - Reserved**
This switch position is reserved and set to Off (the default).
- **Switch position 4 - Reserved**
This switch position is reserved and set to Off (the default).

Chapter 3. Installing and replacing components

This chapter provides instructions for installing and replacing components.

Installation guidelines

Before you begin installing your expansion unit, read the following information:

- Read the safety information beginning on page v and the guidelines in “Handling static-sensitive devices”. This information will help you work safely with your expansion unit and options.
- Make sure that you have an adequate number of properly grounded electrical outlets for your expansion unit and other devices that you will connect to the expansion unit.
- Back up all important data before you make changes to disk drives.
- You do not need to turn off the expansion unit to install or replace hot-swap power supply with fan units, hot-swap hard disk drives, or ESMs.
- The orange color on components and labels identifies hot-swap or hot-plug components. You can install or remove hot-swap and hot-plug components while the expansion unit is running.
- The blue color on components and labels indicates touch points, where a component can be gripped, a latch moved, and so on.
- For a list of supported options for your expansion unit, go to <http://www.ibm.com/us/compat/>.

System reliability guidelines

To help ensure proper cooling and system reliability, make sure that:

- Each of the drive bays has a drive or a filler panel and electromagnetic compatibility (EMC) shield installed in it.
- Each of the power-supply bays has a power supply installed in it.
- There is adequate space around the expansion unit to allow the enclosure cooling system to work properly. Leave approximately 50 mm (2.0 in.) of open space around the front and rear of the expansion unit. Do not place objects in front of the power supplies with fan units.
- You have replaced a failed power supply with fan unit within 48 hours.
- You have replaced a hot-swap hard disk drive within 2 minutes of removal with a new drive or filler panel.

Handling static-sensitive devices

Attention: Static electricity can damage electronic devices and your expansion unit. To avoid damage, keep static-sensitive devices in their static-protective packages until you are ready to install them.

To reduce the possibility of damage from electrostatic discharge, observe the following precautions:

- Limit your movement. Movement can cause static electricity to build up around you.
- Handle the device carefully, holding it by its edges or its frame.
- Do not touch solder joints, pins, or exposed circuitry.
- Do not leave the device where others can handle and damage it.

- While the device is still in its static-protective package, touch it to an unpainted metal part of the expansion unit for at least 2 seconds. This drains static electricity from the package and from your body.
- Remove the device from its package and install it directly into the expansion unit without setting down the device. If it is necessary to set down the device, put it back into its static-protective package. Do not place the device on your expansion unit enclosure or on a metal surface.
- Take additional care when handling devices during cold weather. Heating reduces indoor humidity and increases static electricity.

Working with hot-swap hard disk drives

This section explains how you can increase the expansion unit capacity by adding more drives or replacing existing drives with larger capacity drives.

Before you remove drive CRUs, review the following information:

Hot-swap hardware

You can replace a failed hard disk drive without turning off the expansion unit. Therefore, you can continue to operate your system while a hard disk drive is removed or installed. These drives are known as *hot-swap* drives.

Hard disk drives

Your expansion unit supports IBM Ultra320 SCSI hard disk drives. These IBM drives come pre-installed in a drive tray, ready for installation. (Do not detach the drive from the tray.) This drive and tray assembly is called a *customer replaceable unit (CRU)*. You can install the drives directly into the 14 drive bays on the front of the expansion unit. Be sure to record the location information for each drive *before* you remove it. Ensure that you keep track of the drives and their corresponding bays. Also, record the location information in the Installed-device records section of the *Installation Guide*.

Attention: If you reinstall a hard disk drive in the wrong bay, you can lose data.

Hard disk drive LEDs

Each hard disk drive bezel has two LEDs that indicate the status for that particular hard disk drive. The drive LED states and descriptions are as follows:

LED	LED state	Description
Activity LED	Green/flashing	Flashes during read/write or inquiry operations to the hard disk drive.
Status LED	Amber/flashing	Flashes to indicate a hard disk drive rebuild is under way or that a hard disk drive has been identified by the system-management software.
Status LED	Amber On	Lit continuously to indicate a drive failure.

Filler panels

Expansion units come with drive filler panels in the drive bays. Before

installing new drives, remove the filler panels and save them for future use. Each of the 14 bays must contain either a filler panel or a hard disk drive.

Hard disk drives

You can install only slim Ultra320 hot-swap hard disk drives in the expansion unit.

Replacing a hot-swap hard disk drive

Hard disk drive problems include any malfunctions that delay, interrupt, or prevent successful I/O activity between the hosts and the hard disk drives in the expansion unit. This includes transmission problems between the host controllers, the ESMS, and the drives. This section explains how to replace a failed drive.

Attention: Failure to replace a hard disk drive in the correct bay might result in loss of data. If you have data stored on the hard disk drive, label the drive before you remove it. Then, when you replace the drive, install it in the same drive bay from which you removed it.

Check the hardware and software documentation provided with your server to see if there are restrictions regarding hard disk drive configurations. Some system SCSI configurations might not allow mixing different hard disk drive capacities or types within an array.

Complete the following steps to replace a hot-swap hard disk drive:

1. Read the instructions that come with the hard disk drive.
2. Read the safety information beginning on page v and “Installation guidelines” on page 17.

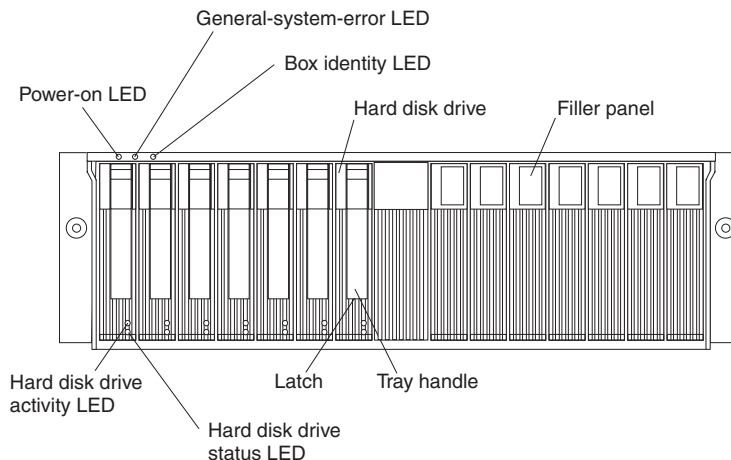

3. Determine the location of the hard disk drive that you want to remove.

Attention: Never hot-swap a hard disk drive when its green activity LED is flashing. Hot-swap a drive only when its amber status LED is lit (not flashing) or when the drive is inactive (activity LED is off).

4. Remove the hard disk drive.

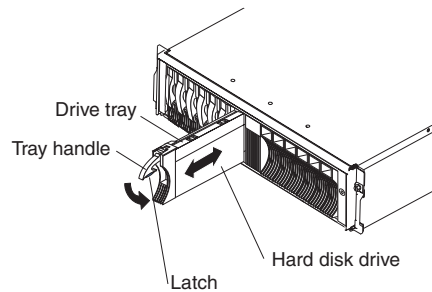

- a. Press the latch on the bottom of the tray handle to release it.
 - b. Pull out the tray handle to the open position.
 - c. Lift the drive partially out of the bay and wait at least 20 seconds before fully removing the drive from the expansion unit. This enables the drive to spin down and avoids possible damage to the drive.
 - d. Verify that there is proper identification (such as a label) on the hard disk drive; then, gently slide it completely out of the expansion unit.
5. Install the new hard disk drive.
 - a. Gently push the drive into the empty bay until the tray handle touches the expansion unit tray.
 - b. Push down the tray handle into the closed (latched) position.
 6. Check the hard disk drive LEDs.
 - a. When a drive is ready for use, the green activity LED and the amber status LED are off.
 - b. If the amber status LED is lit and not flashing, remove the drive from the unit and wait 10 seconds; then, reinstall the drive. If the amber LED is flashing, the drive is rebuilding.

ServeRAID information In some cases, the ServeRAID controller will automatically reset the drive to the Hot Spare or Rebuild state. If the drive state change does not occur automatically (amber LED stays lit), refer to your ServeRAID documentation for information about manually changing the state of the drive from the current state to another state, such as Hot Spare or Ready. The amber LED should turn off within 10 seconds after the drive-state change.

Replacing a bridge card

Attention: Before replacing the bridge card, you must turn off the expansion unit. See “Turning off the expansion unit” on page 10 for detailed instructions.

Complete the following steps to replace the bridge card:

1. Read the safety information beginning on page v and “Installation guidelines” on page 17.
2. Turn off the expansion unit. See “Turning off the expansion unit” on page 10.
3. For easier removal and installation of the bridge card, remove the hard disk drive or filler panel from drive bays 7 and 8 (the drive bays immediately left and right of the bridge card bay). You do not need to remove all of the hard disk drives and filler panels. For instructions for removing filler panels or hard disk drives, see “Replacing a hot-swap hard disk drive” on page 19.

4. Squeeze the bridge-card cover tabs and pull it off.

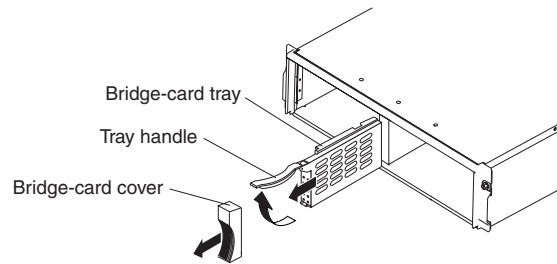

5. Lift the tray handle and pull the tray that contains the bridge card out of the bridge card bay.
6. Hold the new bridge card tray so that the tray handle is at the top of the bridge card tray and pointing outward.
7. Gently slide the tray that contains the bridge card into the bridge card bay.
8. Push down the tray handle to lock the bridge card into place.
9. Replace the bridge card cover by squeezing each of the four tabs, locking the cover into place.
10. Turn on the expansion unit. See “Turning on the expansion unit” on page 10.

Replacing an ESM

You can replace a hot-swap ESM and SCSI cable without turning off power to the expansion unit.

Note: If you are replacing a left ESM that has failed, read the following information:

- If you hot-swap the ESM that has failed, the new ESM will automatically assume the previous configuration switch settings.
- If you remove the left ESM that has failed and then turn off the expansion unit, the configuration returns to the default configuration switch settings when the new ESM is installed.

Complete the following steps to replace an ESM:

1. Read the safety information beginning on page v and “Installation guidelines” on page 17.
2. Disconnect the SCSI cable from the ESM.

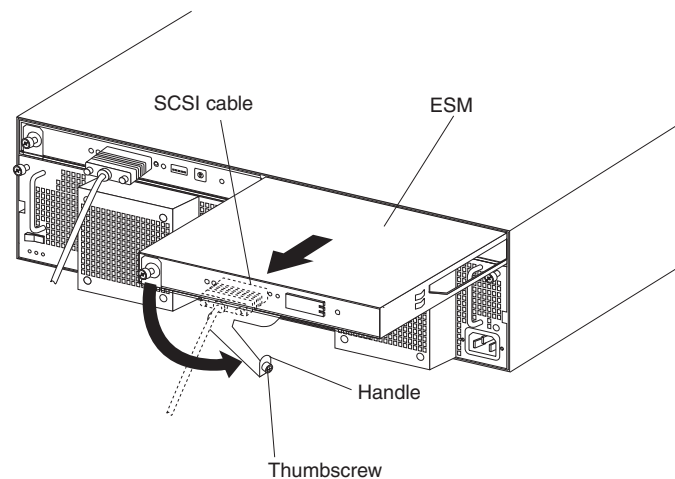

3. Loosen the thumbscrew on the left side of the ESM that you want to replace.
4. Rotate the handle out and to the right.
5. Using the handle, gently slide the ESM out of the expansion unit.
6. If you are replacing the left ESM, set the configuration switches on the new ESM before installing it into the ESM bay. See Chapter 2, “ESM configuration switches”, on page 13.
7. Hold the new ESM so the handle is attached to the bottom of the tray, and the handle is fully extended.
8. Gently slide the ESM into the bay, and move the handle to the closed position (left) until it clicks.
9. Tighten the thumbscrew to secure the handle to the ESM.
10. If the switch cover is not preinstalled on the right ESM, install it now:
 - a. Position the hook on the back of the switch cover to the right of the metal loop on the ESM as shown in the illustration.

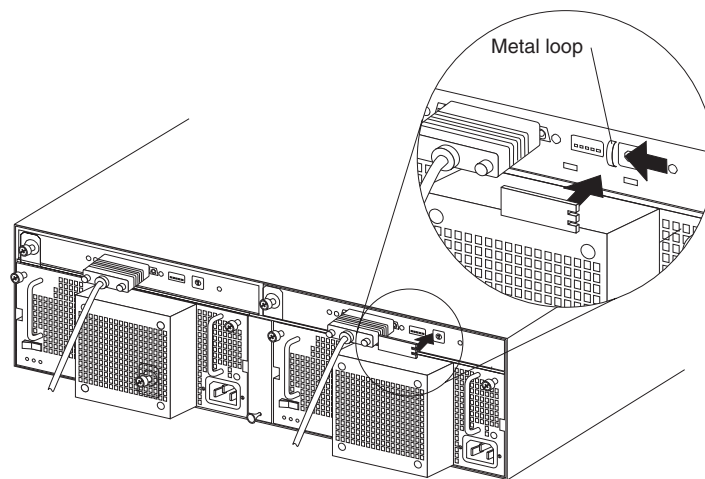

- b. Press the switch cover in place; then slide it to the left until the tab locks under the metal loop on the right ESM.
11. Connect a SCSI cable to the ESM.

Replacing a hot-swap power supply with fan unit

Before replacing a power supply with fan unit, read the following important information:

- The power supply with fan unit does not require preventive maintenance.
- The power supply with fan unit must be installed in the proper place to maintain proper expansion unit cooling.
- Use only power supplies that are supported for your specific expansion unit.

Complete the following steps to replace a hot-swap power supply with fan unit:

1. Read the safety information beginning on page v and “Installation guidelines” on page 17.
2. Turn off the power supply.
3. Unplug the power supply cord from the electrical outlet.
4. Disconnect the power cord from the power supply.
5. Loosen the two thumbscrews on the power supply.

6. Grasp the handles on each side of the power supply and pull the unit out of the expansion unit.

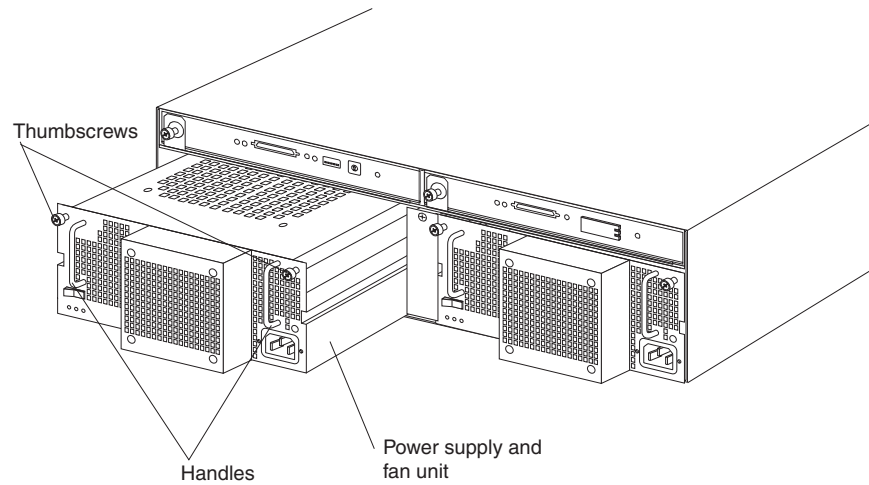

7. Ensure that the new power supply you are installing is turned off.
8. Grasp the handles on the new power supply with fan unit and slide it into the expansion unit.
9. Tighten the two thumbscrews on the power supply.
10. Connect the power cord to the power supply.
11. Plug the supply power cord into a properly grounded electrical outlet.

Note: The fault (amber) LED is lit on the new power supply because its power switch is turned off.

12. Turn on the power supply.
After you turn on the power, the fault (amber) LED is off and the ac and dc power (green) LEDs are lit.

Chapter 4. Information for the -48 volt dc power model

Attention: Only a trained service technician may connect or disconnect the -48 volt dc power supply from its power source, install or remove the power connection on the rear of the expansion unit, and remove or install the power supply in the expansion unit.

Important: To be compliant with EN55024:1998, the power cables for this -48 volt dc product must not exit the building in which the equipment is installed.

This chapter provides instructions for connecting the power supply to a power-distribution unit and for replacing the power supply in the expansion unit. Read this chapter completely before making the power connections.

The following illustration shows the major components of the -48 volt dc power supply.

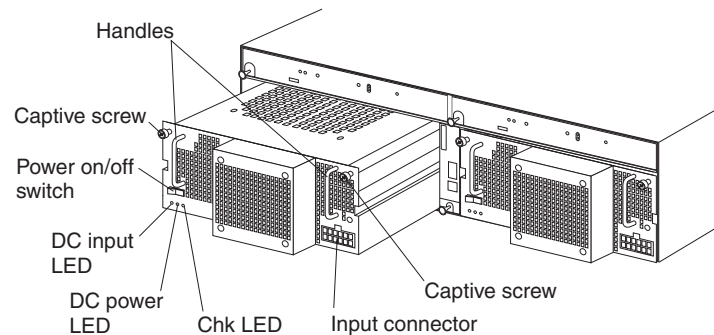

Handle: Use the two handles for installing and removing the power supply.

Captive screws: Use these screws to secure the power supply to the expansion unit.

Power on/off switch: Press this switch to turn the power supply on and off.

DC input LED: When this LED is lit, it indicates that the power supply is receiving dc power from the external power-distribution unit.

DC power LED: When this LED is lit, it indicates that the power supply is supplying power to the expansion unit.

Chk LED: When this LED is lit, it indicates that the power supply has failed or the power switch is turned off. When this LED is flashing, the fan has failed.

Input connector: Connect the dc cable to this connector.

The input connector is a 12-position connector at the lower-right side of the power supply. The following illustration shows the pin-number assignments as viewed from the wiring side.

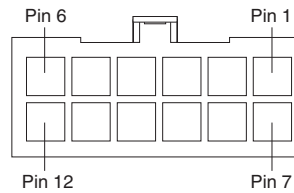

The pin assignments are shown in the following table. For cable connection instructions, see “Connecting the power supply to a power-distribution unit”.

Table 4. Input connector pin assignments

Pin	Assignment	Pin	Assignment
1	Frame ground	7	Frame ground
2	Not used	8	Not used
3	-48 V return (0 V)	9	-48 V return (0 V)
4	-48 V return (0 V)	10	-48 V return (0 V)
5	-48 V in	11	-48 V in
6	-48 V in	12	-48 V in

Connecting the power supply to a power-distribution unit

The following instructions are an overview of the procedure for connecting the power supply to a power-distribution unit. For specific information about connecting the power cable to a power-distribution unit, see the installation instructions that come with the power-distribution unit.

Complete the following steps to connect the power supply to a power-distribution unit:

1. Review the safety information beginning on page v.
2. Connect the dc cable to the input connector on the power supply. Make sure that the dc cable is fully seated in the connector and locks into place.

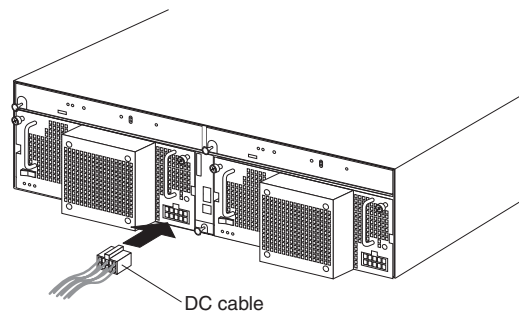

3. Open the terminal-block cover on the power-distribution unit.
4. Connect the wires on the dc cable to the power-distribution unit.

Attention: You must connect the wires in the order described to ensure proper operation of the power supply. The wires are color-coded.



- a. Connect the frame ground (green and yellow) to the main ground terminal (also known as earth ground) in the terminal block.
 - b. Connect the 0 V wire (blue) to the return terminal on the terminal block.
 - c. Connect the -48 V wire (brown) to the -48 V terminal on the terminal block.
5. Close the terminal-block cover.
 6. Turn on the power supply. Check the LEDs for proper operation of the power supply.

Disconnecting and removing the dc power supply

Statement 19:



CAUTION:

The power-control button on the device does not turn off the electrical current supplied to the device. The device also might have more than one connection to dc power. To remove all electrical current from the device, ensure that all connections to dc power are disconnected at the dc power input terminals.

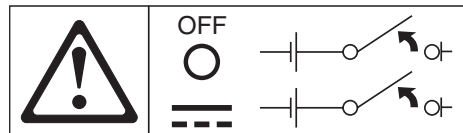

Complete the following steps to disconnect the dc power connection and remove the power supply from the expansion unit:

1. See your operating-system documentation and “Turning off the expansion unit” on page 10 for the proper procedure to shut down the system.
2. When the expansion unit is ready for shutdown, press the power on/off switch on the power supply.
3. Turn off the power from the power-distribution unit. See the documentation that comes with the power-distribution unit.

Note: If you need to disconnect the cables from the power-distribution unit, see the documentation that comes with the power-distribution unit.

4. Remove the dc cable from the input connector on the power supply.
5. Loosen the captive screws on the power supply and remove the power supply from the bay of the expansion unit.

Installing the dc power supply

Attention: Do not use the power supply with an ac input power supply in the same expansion unit.

Complete the following steps to install the power supply:

1. Review the safety information beginning on page v.
2. Make sure that the power supply is turned off.
3. Insert the power supply into the open bay until it is fully seated in the expansion unit.

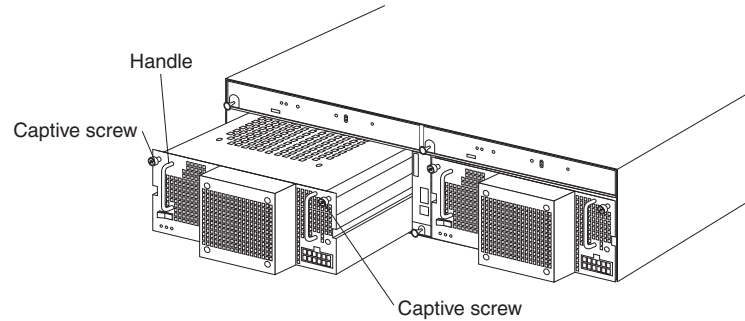

4. Tighten the two captive screws by turning them clockwise.
5. For instructions about how to connect the power supply to a power-distribution unit, see “Connecting the power supply to a power-distribution unit” on page 26.

Chapter 5. Solving problems

The following table contains troubleshooting information to help you solve some of the basic problems you might have with your expansion unit. It contains the problem symptoms and suggested actions to take to resolve the problem.

Table 5. Troubleshooting information

Component	Problem indicator	Possible cause	Possible solutions
Drive CRU	Amber LED on	Drive failure	Replace the failed hard disk drive. See “Working with hot-swap hard disk drives” on page 18.
ESM		Board failure	Replace the failed ESM. See “Replacing an ESM” on page 21.
Front panel		General machine fault	Indicates that a status or fault LED somewhere on the expansion unit is turned on. Check for amber LEDs on CRUs. See “Expansion unit controls, LEDs, components, connectors” on page 6.
All CRUs	All green LEDs off	The expansion unit is turned off	Check that all expansion unit power cables are plugged in and the power is on. If applicable, check that the main circuit breakers for the rack are turned on. If configuration switch SW1 is set to Off, the SCSI controller must be cabled to the expansion unit and turned on.
		ac or dc power failure	Check the main circuit breaker and ac or dc outlet.
		Power supply failed	Replace the power supply CRU. See “Replacing a hot-swap power supply with fan unit” on page 22.
		Midplane failure	Have the expansion unit serviced.
Drive CRUs	Amber LED flashing	Drive rebuild or identity is in process	No corrective action is needed.
Power supply CRU		Fan failure	Replace the power supply CRU.
Power supply CRU	Amber LED on and green dc power LED off	Power supply failure or power supply is turned off.	If the power switch is on, replace the power supply CRU. See “Replacing a hot-swap power supply with fan unit” on page 22.
Power supply CRU	Amber LED on and green ac power LED off	No ac power to power supply. Check the ac power cord (cable) or breaker	If ac power is good at the source, replace the power cord CRU. If the power supply has failed, replace the power supply CRU. See “Replacing a hot-swap power supply with fan unit” on page 22.
Drive CRU ID=6	Green LED on	Cluster configuration	If not currently configured for clustering, power cycle the expansion unit to reenable ID=6.

Table 5. Troubleshooting information (continued)

Component	Problem indicator	Possible cause	Possible solutions
One or more drive CRUs	One or more green LEDs are off	No activity to the drives	No action is required.
All drive CRUs or those on one bus		No activity to the drives	No action is required.
		Damaged or loose SCSI cables	Check the SCSI-bus cables and connections.
		ESM failure	Use the system-management software to check the SCSI-bus status. Replace the ESM. See "Replacing an ESM" on page 21.
		Midplane failure	Have the expansion unit serviced.
Front panel		Power supply	Make sure the cables are plugged in and power supplies are turned on.
	Hardware failure	If any other LEDs are lit, have the expansion unit serviced.	
Some or all CRUs	Intermittent or sporadic power loss to the expansion unit	Defective ac or dc power source or partially plugged power cable	Check the ac or dc power source. Secure all installed power cables and power supplies. If applicable, check the power components (power supply units, uninterruptible power supply, and so on). Replace defective power cables.
		Power supply failure	Check for a fault LED on the power supply and replace the failed CRU. See "Replacing a hot-swap power supply with fan unit" on page 22.
		Midplane failure	Have the expansion unit serviced.
Drives and SCSI bus	Unable to access drives on one or both SCSI buses	Incorrect SCSI ID settings	Make sure the SCSI cables are undamaged and properly connected. Check the drive SCSI ID settings. Be sure that configuration switches SW3 and SW4 (on the ESM) are set to the appropriate positions. Attention: Change configuration switch positions only when your host server and expansion unit are turned off.
		ESM failure	Have the expansion unit serviced.
Bridge card		Bridge card failure	All high address or all low address hard disk drives failed; check the bridge card CRU and replace if necessary. See "Replacing a bridge card" on page 20.
Subsystem	Random errors	Midplane failure	Have the expansion unit serviced.

Appendix A. Getting help and technical assistance

If you need help, service, or technical assistance or just want more information about IBM products, you will find a wide variety of sources available from IBM to assist you. This appendix contains information about where to go for additional information about IBM and IBM products, what to do if you experience a problem with your xSeries or IntelliStation[®] system, and whom to call for service, if it is necessary.

Before you call

Before you call, make sure that you have taken these steps to try to solve the problem yourself:

- Check all cables to make sure that they are connected.
- Check the power switches to make sure that the system is turned on.
- Use the troubleshooting information in your system documentation, and use the diagnostic tools that come with your system.
- Go to the IBM Support Web site at <http://www.ibm.com/pc/support/> to check for technical information, hints, tips, and new device drivers.
- Use an IBM discussion forum on the IBM Web site to ask questions.

You can solve many problems without outside assistance by following the troubleshooting procedures that IBM provides in the online help or in the publications that are provided with your system and software. The information that comes with your system also describes the diagnostic tests that you can perform. Most xSeries and IntelliStation systems, operating systems, and programs come with information that contains troubleshooting procedures and explanations of error messages and error codes. If you suspect a software problem, see the information for the operating system or program.

Using the documentation

Information about your IBM xSeries or IntelliStation system and preinstalled software, if any, is available in the documentation that comes with your system. That documentation includes printed books, online books, readme files, and help files. See the troubleshooting information in your system documentation for instructions for using the diagnostic programs. The troubleshooting information or the diagnostic programs might tell you that you need additional or updated device drivers or other software. IBM maintains pages on the World Wide Web where you can get the latest technical information and download device drivers and updates. To access these pages, go to <http://www.ibm.com/pc/support/> and follow the instructions. Also, you can order publications through the IBM Publications Ordering System at <http://www.elink.ibm.com/public/applications/publications/cgibin/pbi.cgi>.

Getting help and information from the World Wide Web

On the World Wide Web, the IBM Web site has up-to-date information about IBM xSeries and IntelliStation products, services, and support. The address for IBM xSeries information is <http://www.ibm.com/eserver/xseries/>. The address for IBM IntelliStation information is <http://www.ibm.com/pc/intellistation/>.

You can find service information for your IBM products, including supported options, at <http://www.ibm.com/pc/support/>.

Software service and support

Through IBM Support Line, you can get telephone assistance, for a fee, with usage, configuration, and software problems with xSeries servers, IntelliStation workstations, and appliances. For information about which products are supported by Support Line in your country or region, go to <http://www.ibm.com/services/sl/products/>.

For more information about Support Line and other IBM services, go to <http://www.ibm.com/services/>, or go to <http://www.ibm.com/planetwide/> for support telephone numbers. In the U.S. and Canada, call 1-800-IBM-SERV (1-800-426-7378).

Hardware service and support

You can receive hardware service through IBM Integrated Technology Services or through your IBM reseller, if your reseller is authorized by IBM to provide warranty service. Go to <http://www.ibm.com/planetwide/> for support telephone numbers, or in the U.S. and Canada, call 1-800-IBM-SERV (1-800-426-7378).

In the U.S. and Canada, hardware service and support is available 24 hours a day, 7 days a week. In the U.K., these services are available Monday through Friday, from 9 a.m. to 6 p.m.

Appendix B. Notices

This information was developed for products and services offered in the U.S.A.

IBM may not offer the products, services, or features discussed in this document in other countries. Consult your local IBM representative for information on the products and services currently available in your area. Any reference to an IBM product, program, or service is not intended to state or imply that only that IBM product, program, or service may be used. Any functionally equivalent product, program, or service that does not infringe any IBM intellectual property right may be used instead. However, it is the user's responsibility to evaluate and verify the operation of any non-IBM product, program, or service.

IBM may have patents or pending patent applications covering subject matter described in this document. The furnishing of this document does not give you any license to these patents. You can send license inquiries, in writing, to:

*IBM Director of Licensing
IBM Corporation
North Castle Drive
Armonk, NY 10504-1785
U.S.A.*

INTERNATIONAL BUSINESS MACHINES CORPORATION PROVIDES THIS PUBLICATION "AS IS" WITHOUT WARRANTY OF ANY KIND, EITHER EXPRESS OR IMPLIED, INCLUDING, BUT NOT LIMITED TO, THE IMPLIED WARRANTIES OF NON-INFRINGEMENT, MERCHANTABILITY OR FITNESS FOR A PARTICULAR PURPOSE. Some states do not allow disclaimer of express or implied warranties in certain transactions, therefore, this statement may not apply to you.

This information could include technical inaccuracies or typographical errors. Changes are periodically made to the information herein; these changes will be incorporated in new editions of the publication. IBM may make improvements and/or changes in the product(s) and/or the program(s) described in this publication at any time without notice.

Any references in this information to non-IBM Web sites are provided for convenience only and do not in any manner serve as an endorsement of those Web sites. The materials at those Web sites are not part of the materials for this IBM product, and use of those Web sites is at your own risk.

IBM may use or distribute any of the information you supply in any way it believes appropriate without incurring any obligation to you.

Edition notice

© Copyright International Business Machines Corporation 2003. All rights reserved.

U.S. Government Users Restricted Rights — Use, duplication, or disclosure restricted by GSA ADP Schedule Contract with IBM Corp.

Trademarks

The following terms are trademarks of International Business Machines Corporation in the United States, other countries, or both:

e-business logo	Netfinity
@server	ServeRAID
IBM	ServerProven
IntelliStation	ThinkPad
NetBAY	xSeries

Lotus, Lotus Notes, SmartSuite, and Domino are trademarks of Lotus Development Corporation and/or IBM Corporation in the United States, other countries, or both.

Microsoft, Windows, and Windows NT are trademarks of Microsoft Corporation in the United States, other countries, or both.

Other company, product, or service names may be trademarks or service marks of others.

Important notes

Processor speeds indicate the internal clock speed of the microprocessor; other factors also affect application performance.

CD-ROM drive speeds list the variable read rate. Actual speeds vary and are often less than the maximum possible.

When referring to processor storage, real and virtual storage, or channel volume, KB stands for approximately 1000 bytes, MB stands for approximately 1 000 000 bytes, and GB stands for approximately 1 000 000 000 bytes.

When referring to hard disk drive capacity or communications volume, MB stands for 1 000 000 bytes, and GB stands for 1 000 000 000 bytes. Total user-accessible capacity may vary depending on operating environments.

Maximum internal hard disk drive capacities assume the replacement of any standard hard disk drives and population of all hard disk drive bays with the largest currently supported drives available from IBM.

Maximum memory may require replacement of the standard memory with an optional memory module.

IBM makes no representation or warranties regarding non-IBM products and services that are ServerProven[®], including but not limited to the implied warranties of merchantability and fitness for a particular purpose. These products are offered and warranted solely by third parties.

IBM makes no representations or warranties with respect to non-IBM products. Support (if any) for the non-IBM products is provided by the third party, not IBM.

Some software may differ from its retail version (if available), and may not include user manuals or all program functionality.

Product recycling and disposal

This unit contains materials such as circuit boards, cables, electromagnetic compatibility gaskets, and connectors which may contain lead and copper/beryllium alloys that require special handling and disposal at end of life. Before this unit is disposed of, these materials must be removed and recycled or discarded according to applicable regulations. IBM offers product-return programs in several countries. For country-specific instructions, refer to the following Web site:
<http://www.ibm.com/ibm/environment/products/prp.shtml>.

This product may contain a sealed lead acid, nickel cadmium, nickel metal hydride, lithium, or lithium ion battery. Consult your user manual or service manual for specific battery information. The battery must be recycled or disposed of properly. Recycling facilities may not be available in your area. For information on disposal of batteries, contact your local waste disposal facility.

In the United States, IBM has established a collection process for reuse, recycling, or proper disposal of used IBM sealed lead acid, nickel cadmium, nickel metal hydride, and battery packs from IBM equipment. For information on proper disposal of these batteries, contact IBM at 1-800-426-4333. Have the IBM part number listed on the battery available prior to your call.

Electronic emission notices

Federal Communications Commission (FCC) statement

Note: This equipment has been tested and found to comply with the limits for a Class A digital device, pursuant to Part 15 of the FCC Rules. These limits are designed to provide reasonable protection against harmful interference when the equipment is operated in a commercial environment. This equipment generates, uses, and can radiate radio frequency energy and, if not installed and used in accordance with the instruction manual, may cause harmful interference to radio communications. Operation of this equipment in a residential area is likely to cause harmful interference, in which case the user will be required to correct the interference at his own expense.

Properly shielded and grounded cables and connectors must be used in order to meet FCC emission limits. Properly shielded and grounded cables and connectors must be used in order to meet FCC emission limits. IBM is not responsible for any radio or television interference caused by using other than recommended cables and connectors or by using other than recommended cables and connectors or by unauthorized changes or modifications to this equipment. Unauthorized changes or modifications could void the user's authority to operate the equipment.

This device complies with Part 15 of the FCC Rules. Operation is subject to the following two conditions: (1) this device may not cause harmful interference, and (2) this device must accept any interference received, including interference that may cause undesired operation.

Industry Canada Class A emission compliance statement

This Class A digital apparatus complies with Canadian ICES-003.

Avis de conformité à la réglementation d'Industrie Canada

Cet appareil numérique de la classe A est conforme à la norme NMB-003 du Canada.

Australia and New Zealand Class A statement

Attention: This is a Class A product. In a domestic environment this product may cause radio interference in which case the user may be required to take adequate measures.

United Kingdom telecommunications safety requirement

Notice to Customers

This apparatus is approved under approval number NS/G/1234/J/100003 for indirect connection to public telecommunication systems in the United Kingdom.

European Union EMC Directive conformance statement

This product is in conformity with the protection requirements of EU Council Directive 89/336/EEC on the approximation of the laws of the Member States relating to electromagnetic compatibility. IBM cannot accept responsibility for any failure to satisfy the protection requirements resulting from a nonrecommended modification of the product, including the fitting of non-IBM option cards.

This product has been tested and found to comply with the limits for Class A Information Technology Equipment according to CISPR 22/European Standard EN 55022. The limits for Class A equipment were derived for commercial and industrial environments to provide reasonable protection against interference with licensed communication equipment.

Attention: This is a Class A product. In a domestic environment this product may cause radio interference in which case the user may be required to take adequate measures.

Taiwanese Class A warning statement

警告使用者：
這是甲類的資訊產品，在居住的環境中使用時，可能會造成射頻干擾，在這種情況下，使用者會被要求採取某些適當的對策。

Chinese Class A warning statement

声 明
此为 A 级产品。在生活环境中，
该产品可能会造成无线电干扰。
在这种情况下，可能需要用户对其
干扰采取切实可行的措施。

Japanese Voluntary Control Council for Interference (VCCI) statement

この装置は、情報処理装置等電波障害自主規制協議会（VCCI）の基準に基づくクラスA情報技術装置です。この装置を家庭環境で使用すると電波妨害を引き起こすことがあります。この場合には使用者が適切な対策を講ずるよう要求されることがあります。

Power cords

For your safety, IBM provides a power cord with a grounded attachment plug to use with this IBM product. To avoid electrical shock, always use the power cord and plug with a properly grounded outlet.

IBM power cords used in the United States and Canada are listed by Underwriter's Laboratories (UL) and certified by the Canadian Standards Association (CSA).

For units intended to be operated at 115 volts: Use a UL-listed and CSA-certified cord set consisting of a minimum 18 AWG, Type SVT or SJT, three-conductor cord, a maximum of 15 feet in length and a parallel blade, grounding-type attachment plug rated 15 amperes, 125 volts.

For units intended to be operated at 230 volts (U.S. use): Use a UL-listed and CSA-certified cord set consisting of a minimum 18 AWG, Type SVT or SJT, three-conductor cord, a maximum of 15 feet in length and a tandem blade, grounding-type attachment plug rated 15 amperes, 250 volts.

For units intended to be operated at 230 volts (outside the U.S.): Use a cord set with a grounding-type attachment plug. The cord set should have the appropriate safety approvals for the country in which the equipment will be installed.

IBM power cords for a specific country or region are usually available only in that country or region.

IBM power cord part number	Used in these countries and regions
02K0546	China
13F9940	Australia, Fiji, Kiribati, Nauru, New Zealand, Papua New Guinea

IBM power cord part number	Used in these countries and regions
13F9979	Afghanistan, Albania, Algeria, Andorra, Angola, Armenia, Austria, Azerbaijan, Belarus, Belgium, Benin, Bosnia and Herzegovina, Bulgaria, Burkina Faso, Burundi, Cambodia, Cameroon, Cape Verde, Central African Republic, Chad, Comoros, Congo (Democratic Republic of), Congo (Republic of), Cote D'Ivoire (Ivory Coast), Croatia (Republic of), Czech Republic, Dahomey, Djibouti, Egypt, Equatorial Guinea, Eritrea, Estonia, Ethiopia, Finland, France, French Guyana, French Polynesia, Germany, Greece, Guadeloupe, Guinea, Guinea Bissau, Hungary, Iceland, Indonesia, Iran, Kazakhstan, Kyrgyzstan, Laos (People's Democratic Republic of), Latvia, Lebanon, Lithuania, Luxembourg, Macedonia (former Yugoslav Republic of), Madagascar, Mali, Martinique, Mauritania, Mauritius, Mayotte, Moldova (Republic of), Monaco, Mongolia, Morocco, Mozambique, Netherlands, New Caledonia, Niger, Norway, Poland, Portugal, Reunion, Romania, Russian Federation, Rwanda, Sao Tome and Principe, Saudi Arabia, Senegal, Serbia, Slovakia, Slovenia (Republic of), Somalia, Spain, Suriname, Sweden, Syrian Arab Republic, Tajikistan, Tahiti, Togo, Tunisia, Turkey, Turkmenistan, Ukraine, Upper Volta, Uzbekistan, Vanuatu, Vietnam, Wallis and Futuna, Yugoslavia (Federal Republic of), Zaire
13F9997	Denmark
14F0015	Bangladesh, Lesotho, Maceo, Maldives, Namibia, Nepal, Pakistan, Samoa, South Africa, Sri Lanka, Swaziland, Uganda
14F0033	Abu Dhabi, Bahrain, Botswana, Brunei Darussalam, Channel Islands, China (Hong Kong S.A.R.), Cyprus, Dominica, Gambia, Ghana, Grenada, Iraq, Ireland, Jordan, Kenya, Kuwait, Liberia, Malawi, Malaysia, Malta, Myanmar (Burma), Nigeria, Oman, Polynesia, Qatar, Saint Kitts and Nevis, Saint Lucia, Saint Vincent and the Grenadines, Seychelles, Sierra Leone, Singapore, Sudan, Tanzania (United Republic of), Trinidad and Tobago, United Arab Emirates (Dubai), United Kingdom, Yemen, Zambia, Zimbabwe
14F0051	Liechtenstein, Switzerland
14F0069	Chile, Italy, Libyan Arab Jamahiriya
14F0087	Israel
1838574	Antigua and Barbuda, Aruba, Bahamas, Barbados, Belize, Bermuda, Bolivia, Brazil, Caicos Islands, Canada, Cayman Islands, Costa Rica, Colombia, Cuba, Dominican Republic, Ecuador, El Salvador, Guam, Guatemala, Haiti, Honduras, Jamaica, Japan, Mexico, Micronesia (Federal States of), Netherlands Antilles, Nicaragua, Panama, Peru, Philippines, Taiwan, United States of America, Venezuela
24P6858	Korea (Democratic People's Republic of), Korea (Republic of)
34G0232	Japan
36L8880	Argentina, Paraguay, Uruguay
49P2078	India
49P2110	Brazil

IBM power cord part number	Used in these countries and regions
6952300	Antigua and Barbuda, Aruba, Bahamas, Barbados, Belize, Bermuda, Bolivia, Caicos Islands, Canada, Cayman Islands, Colombia, Costa Rica, Cuba, Dominican Republic, Ecuador, El Salvador, Guam, Guatemala, Haiti, Honduras, Jamaica, Mexico, Micronesia (Federal States of), Netherlands Antilles, Nicaragua, Panama, Peru, Philippines, Saudi Arabia, Thailand, Taiwan, United States of America, Venezuela

Index

Special characters

- 48 volt dc power supply
 - connecting to power-distribution unit 26
 - disconnecting 27
 - installing 28
 - overview 25
 - pin assignments 26

A

- ac power connector 8
- ac power LED 8
- activity LED
 - ESM 9
 - front 7
- alerts from systems-management software 12

B

- bridge card
 - bay location 5
 - replacing 20

C

- Class A electronic emission notice 35
- clustering support 4
- configuration switch
 - default settings 13
 - setting for rack and tower 15
 - setting for split SCSI bus 15
 - setting SCSI IDs 14

D

- dc power LED 8
- dc power supply
 - connecting to power-distribution unit 26
 - disconnecting 27
 - installing 28
 - overview 25
 - pin assignments 26
- dimensions of expansion unit 3
- disconnecting -48 volt dc power supply 27
- drives, hard disk 3

E

- electrical input specification 3
- electronic emission Class A notice 35
- emergency situation
 - restarting after an 12
 - shutting down 11
- environmental specifications 3
- ESM user controls 9
 - activity LED 9

- ESM user controls (*continued*)
 - fault LED 9
 - LVD/SE LED 9
 - SCSI bus connectors 9
 - SCSI reset LED 9
 - termination-power LED 9
- ESM, replacing 21
- expansion unit
 - operating specifications 2

F

- fans and redundant cooling 4
- fault LED
 - ESM 9
 - front 7
 - rear 8
- FCC Class A notice 35
- features of expansion unit 2
- filler panels for hard disk drives 18
- front controls and indicators
 - activity LED 7
 - bridge card bay 7
 - drive bays 7
 - drive CRU 7
 - general-system-error LED 7
 - latch 7
 - power-on LED 7
 - status LED 7
 - tray handle 7

H

- hard disk drive
 - location 5
 - replacing 19
 - specification 3
- heat output specification 3
- hot-swap features
 - ESMs 9
 - hard-disk drives 5
 - power supplies 6, 8
- hot-swap power supply
 - replacing 22
- humidity specifications 3

I

- input connector on dc power supply 26

L

- LED states and descriptions (hard-disk drive) 18
- LVD/SE LED 9

N

- noise emissions 3
- notes, important 34
- notices
 - electronic emission 35
 - FCC, Class A 35
 - used in this book 2

O

- online publications 2
- operating specifications 2

P

- pin assignments on dc power input connector 26
- power cords 37
- power off in an emergency 11
- power requirement 3
- power supply
 - bay 6
 - redundant 6
 - replacing 22
 - specifications 3
- power switch 8
- power-off the expansion unit 11
- power-on the expansion unit 10
- power-supply controls, indicators, and connectors
 - ac power connector 8
 - ac power LED 8
 - dc power LED 8
 - fault LED 8
 - power supplies 8
 - power switch 8
 - thumbscrews 8
- problems and solutions 29
- publications, related 1

R

- rear controls, indicators, and connectors.
 - See power-supply controls, indicators, and connectors
- related publications 1
- replacing
 - bridge card 20
 - ESM 21
 - hard disk drive 19
 - power supply 22
- restarting the expansion unit 12

S

- SCSI bus connectors 9
- SCSI buses and IDs 14
- SCSI reset LED 9
- ServeRAID support 4
- shut down in an emergency 11
- shut down the expansion unit 11
- size of expansion unit 3

- specifications, operating 2
- statements and notices used in this book 2
- switch, configuration
 - default settings 13
 - setting for rack and tower 15
 - setting for split SCSI bus 15
 - setting SCSI IDs 14
- systems-management software support 12
- supported alerts 12

T

- temperature specifications 3
- termination-power LED 9
- trademarks 34
- troubleshooting 29
- turning off the expansion unit 11
- turning off the expansion unit in an emergency 11
- turning on the expansion unit 10

U

- United States electronic emission Class A notice 35
- United States FCC Class A notice 35

W

- weight of expansion unit 3



Part Number: 88P9250

Printed in U.S.A.

(1P) P/N: 88P9250

