

IBM PC Servers

S84H-3050-00

PC Server 330 - Type 8640

**Hardware Maintenance
Manual Supplement**

November 1996

**Use this manual with the
PS Servers
Hardware Maintenance Manual**

IBM PC Servers

S84H-3050-00

PC Server 330 - Type 8640

**Hardware Maintenance
Manual Supplement**

November 1996

**Use this manual with the
PS Servers
Hardware Maintenance Manual**



Note

Before using this information and the product it supports, be sure to read the general information under "Notices" on page 194.

First Edition (November 1996)

The following paragraph does not apply to the United Kingdom or any country where such provisions are inconsistent with local law: INTERNATIONAL BUSINESS MACHINES CORPORATION PROVIDES THIS PUBLICATION "AS IS" WITHOUT WARRANTY OF ANY KIND, EITHER EXPRESS OR IMPLIED, INCLUDING, BUT NOT LIMITED TO, THE IMPLIED WARRANTIES OF MERCHANTABILITY OR FITNESS FOR A PARTICULAR PURPOSE. Some states do not allow disclaimer of express or implied warranties in certain transactions, therefore, this statement may not apply to you.

This publication could include technical inaccuracies or typographical errors. Changes are periodically made to the information herein; these changes will be incorporated in new editions of the publication. IBM may make improvements and/or changes in the product(s) and/or the program(s) described in this publication at any time.

It is possible that this publication may contain reference to, or information about, IBM products (machines and programs), programming, or services that are not announced in your country. Such references or information must not be construed to mean that IBM intends to announce such IBM products, programming, or services in your country.

Requests for technical information about IBM products should be made to your IBM reseller or IBM marketing representative.

© Copyright International Business Machines Corporation 1995, 1996. All rights reserved.

Note to U.S. Government users—Documentation related to Restricted rights—Use, duplication, or disclosure is subject to restrictions set forth in GSA ADP Schedule Contract with IBM Corp.

About This Supplement

This supplement contains diagnostic information, Symptom-to-FRU Indexes, service information, error codes, error messages, and configuration information for the PC Server 330 Type 8640.

This supplement should be used with the advanced diagnostic tests and the information in the IBM *Personal System/2 Hardware Maintenance Manual* (part number 83G8990, form number S52G-9971) and *IBM PC Servers Hardware Maintenance Manual* (part number 70H0751, form number S30H-2501) to troubleshoot problems effectively.

Important

This manual is intended for trained servicers who are familiar with IBM PC Server products.

Before servicing an IBM product, be sure to review "Safety Information" on page 182.

Related Publications

The following publications are available for IBM products. For more information, contact IBM or an IBM Authorized Dealer.

For Information About	See Publication
IBM PC Servers not listed in this manual	IBM PC Servers Hardware Maintenance Manual (S30H-2501)
PS/2 Computers	IBM Personal System/2 Hardware Maintenance Manual (S52G-9971)
PS/ValuePoint Computers	IBM PS/ValuePoint Hardware Maintenance Service and Reference (S61G-1423)
Laptop, Notebook, Portable, and ThinkPad Computers (L40, CL57, N45, N51, P70/P75, ThinkPad 300, 350, 500, 510, 710T, Expansion Unit, Dock I, Dock II)	IBM Mobile Systems Hardware Maintenance Manual Volume 1 (S82G-1501)
ThinkPad Computers (ThinkPad 340, 355, 360, 370, 700, 701, 720, 750, 755)	IBM Mobile Systems Hardware Maintenance Manual Volume 2 (S82G-1502)
ThinkPad Computers (ThinkPad 365, 760)	IBM Mobile Systems Hardware Maintenance Manual Volume 3 (S82G-1503)
Monitors (Displays) (February 1993)	IBM PS/2 Display HMM Volume 1 (SA38-0053)
Monitors (December 1993)	IBM Color Monitor HMM Volume 2 (S71G-4197)
IBM Monitors (P Series) (February 1996)	IBM Monitor HMM Volume 3 (S52H-3679)
IBM 2248 Monitor (February 1996)	IBM Monitor HMM Volume 4 (S52H-3739)
Disk Array technology overview and using the IBM RAID Configuration Program	Configuring Your Disk Array booklet (S82G-1506)
Installation Planning for Personal System/2 computers	Personal System/2 Installation Planning and Beyond (G41G-2927)
Installation Planning for Advanced Personal System/2 Servers	Advanced PS/2 Servers Planning and Selection Guide (GG24-3927)

Contents

About This Supplement	iii
Related Publications	iv
General Checkout/Diagnostics QAPLus/PRO	1
General Checkout	2
Diagnostics	3
PC Server 330 - Type 8640	13
Features	17
Diagnostics and Test Information	19
Additional Service Information	20
Locations	135
Symptom-to-FRU Index	165
Parts Listings (PC Server 330 - Type 8640)	173
Parts Listing (PC Server Advanced Systems Management Adapter)	180
Related Service Information	181
Safety Information	182
Battery Notice	187
Laser Compliance Statement	190
Problem Determination Tips	191
Phone Numbers, U.S. and Canada	192
Notices	194

General Checkout/Diagnostics

QAPLus/PRO

General Checkout	2
Diagnostics	3
Power-On Self-Test (POST)	3
POST Beep Codes	3
Test Programs	3
Error Messages	4
Return Codes	5
Using the Test Programs	6
Program Navigation	6
Intruder Alert	6
Using the First Letter of a Menu Choice	6
Using the Function Keys	6
Command Line Options	7
Viewing the Test Groups	8
Scripting	8
Changing Logical Unit Numbers	8
Test Group Specifications	9
Starting the QAPLus/PRO Diagnostics Diskette	9
Module Testing Mode	9
Running Selected Module Tests	10
Running All Selected Modules	10
Changing Selected Tests in Test Groups	10
Running an Individual Test	10
Stopping the Tests	11
QAPLus/PRO Diagnostics Control Keys	11

The following Maintenance Analysis Procedure (MAP) and diagnostic information should be used to isolate problems on servers that are supported by the QAPLus/PRO Diagnostics test.

General Checkout

This general checkout procedure is for computers that are supported by the QAPLus/PRO Diagnostics test.

Diagnostic error messages appear when a test program finds a problem with a hardware option. For the test programs to properly determine if a test *Passed*, *Failed*, or *Aborted*, the test programs check the error-return code at test completion. (See "Return Codes" on page 5.)

General error messages appear if a problem or conflict is found by an application program, the operating system, or both. For an explanation of these messages, refer to the information supplied with that software package.

Notes

1. If multiple error codes are displayed, diagnose the first error code displayed.
2. If the computer reports a POST error, go to "Symptom-to-FRU Index" on page 165.
3. If the computer hangs and no error is displayed, go to "Undetermined Problems" on page 133.
4. If a device cannot be selected from the Module Test menu, that device might be defective.

001

- Power-off the computer and all external devices.
- Check all cables and power cords.
- Set all display controls to the middle position.
- Insert the QAPLus/PRO Diagnostics diskette into drive A.
- Power-on all external devices.
- Power-on the computer.
- Check for the following responses:
 1. One beep.
 2. Readable instructions or the Main Menu.

DID YOU RECEIVE THE CORRECT RESPONSES?

Yes No

002

Find the failure symptom in the "Symptom-to-FRU Index" on page 165.

003

Run the Advanced Diagnostics Test. If necessary, refer to "Diagnostics" on page 3.

If you receive an error, go to the "Symptom-to-FRU Index" on page 165 .

Diagnostics

The following tools are available to help identify and resolve hardware-related problems:

- Power-on self-test (POST)
- POST Beep Codes
- Test programs
- Error messages
- Diagnostics Diskette

Power-On Self-Test (POST)

Each time you power-on the system, it performs a series of tests that check the operation of the system and some options. This series of tests is called the *power-on self-test*, or *POST*. POST does the following:

- Checks some basic system-board operations
- Checks the memory operation
- Starts the video operation
- Verifies that the diskette drives are working
- Verifies that the hard disk drive is working

If the POST finishes without detecting any problems, a single beep sounds and the first screen of the operating system or application program appears.

If the POST detects a problem, an error message appears on the screen. A single problem can cause several error messages to appear. When you correct the cause of the first error message, the other error messages probably will not appear on the screen the next time you power-on the system.

POST Beep Codes

The Power On Self-Test generates a beeping sound to indicate successful completion of POST or to indicate that the tests detect an error.

One beep and the appearance of text on the display indicates successful completion of the POST. More than one beep indicates that the POST detects an error.

Test Programs

The QAPIus/PRO test programs on the PC Server System Board Diagnostic Diskette, developed by DiagSoft for IBM, are the primary method of testing the PC Server. You can use them to test the IBM components of the system and some external devices. The amount of time required to test all components depends on the number of components. The more optional adapters and devices you have attached to the system, the longer the testing takes.

Diagnostic programs from the QAPIus/PRO **Main Menu** include the following features.

Feature	Description
Quick Check	<p>Identifies most problems associated with the following major components:</p> <ul style="list-style-type: none"> • System board • Hard disk drives • Diskette drives • CD-ROM drives • RAM • Serial and parallel ports • Video adapter • Printer • Keyboard • Mouse
Module Test	<p>Allows you to:</p> <ul style="list-style-type: none"> • Run groups of tests in batch • Specify parameters to use for each test (for example, video modes, disk cylinders, port addresses, and so on) • Specify the number of passes you want to run (one to continuous) • Log the test results to a text or dBase Format (DBF) file • Save all test settings for future use • View System Information • View the server's configuration information. (For example, you can view the IRQ/DMA assignments, memory usage, device drivers, and so on.) • Select System Utilities • Format a diskette

Error Messages

Messages generated by the software—the operating system or application programs—generally are text messages, but they also can be numeric. Basically, there are five types of error messages.

- POST error messages
- Diagnostic error messages
- POST beep codes
- Software generated messages.
- Multiple messages

Error Message	Description
POST Error Messages	Displayed when POST finds problems with the hardware or detects a change in the hardware configuration.
POST Beep Codes	Sounds emitted from the speaker if POST finds a problem. One beep indicates POST completed successfully. Multiple beeps indicate a problem was found by the POST.
Diagnostic Error Messages	Displayed when a test program finds a problem with a hardware option.

Error Message	Description
Software Generated Error Messages	Displayed if a problem or conflict is found by an application program, the operating system, or both. For an explanation of these messages, refer to the information supplied with that software package.
Multiple Messages	The first error that occurs can cause additional errors. Follow the suggested action of the first error displayed. In this case, the system displays more than one error message. Always follow the suggested action instructions for the <i>first</i> error message displayed.

Return Codes

For the test programs to properly determine if a test *Passed*, *Failed*, or *Aborted*, the test programs check the error-return code at test completion. To register the test properly in the test log, the test programs must generate one of the following return codes:

Return Code	Description
0	Indicates that the device passed its test.
1	Indicated that the device failed its test.
2 or greater	Indicates that the test stopped or was aborted.

Using the Test Programs

The test programs provide advanced functions and utilities for service or support professionals to troubleshoot even the most difficult problems.

Program Navigation:

You can maneuver within the test programs by typing the first letter of a menu choice, using the function keys, or using command-line options.

Intruder Alert:

When you load QAPLus/PRO diagnostics, Intruder Alert checks for damage to the Diagnostic Diskette. If a virus or program alteration is detected, the diagnostic programs do not load.

To suspend Intruder Alert and continue loading the diagnostic programs, press **Esc**.

Using the First Letter of a Menu Choice

Throughout the test programs, pressing the first letter of an option on a menu is the same as moving to that item with the cursor and pressing Enter; however, this function is not enabled on Test Group Screens.

Using the Function Keys

Use the following keys to maneuver throughout the test programs:

Keys	Action
Enter	Select an item, run the test module, or run the test
Down Arrow (↓)	Moves the cursor down
Up Arrow (↑)	Moves the cursor up
F1	Calls up the appropriate Help information. Use the up arrow key (↑) or the down arrow key (↓) to scroll through the information. Pressing F1 from within a Help screen provides a help index from which you can select different categories. One of the important help categories is function key usage. Pressing Esc exits Help and returns to where you left off.
Esc	Go back to the previous menu

Additional functions are available in the Test Module Selection screen and the Test Group screen using the following keys:

Keys	Action
Tab	Move to test group (or move to parameters)

Keys	Action
Spacebar	Toggle modules on/off (or toggle tests on/off)
F2	View test results log
F10	Local menu
+	Next logical unit number (for example, LUN 1, LUN 2, and so on)
-	Previous logical unit number

Command Line Options

The following Command Line Options are available when initially loading the diagnostic program from within its directory of a DOS operating system. Loading QAPlus/PRO from a DOS system command line allows selected tests and options to run with minimum memory.

At a **DOS** operating system prompt, where the QAPlus/PRO files reside, type **QAPLPRO /XXX** (where **XXX** represents one or more of the following from the list below) then, press **Enter**.

Command	Action
/B&W	The /B&W command line option forces the program to load in Black and White (Monochrome) mode, which is often more readable on laptop computers.
/LOG=file	The /LOG=file command line option directs the test programs to start using a specified Error Log file.
/INT10	The /INT10 command line option forces the test programs to use the BIOS for screen writes.
/OXXX	The /OXXX command line option, where XXX=test group (for example, MBD, MEM, VID, HDU, FDU, KBD, COM, LPT, and so on), omits the designated test group from loading.
/OALL	The /OALL command line option omits all test groups from loading. This command can be used in conjunction with the /IXXX command.
/IXXX	The /IXXX command line option, where XXX=test group (for example, MBD, MEM, VID, HDU, FDU, KBD, COM, LPT, and so on), loads the designated test group for testing. This option is helpful if you have insufficient memory available to load all of the test programs simultaneously.
/USRCONFIG=file	The /USERCONFIG=file command line option tells the test programs to look for a user diagnostic configuration file other than the default USERDIAG.CFG.

Command	Action
/SCRIPT =file[,R]	<p>The /SCRIPT=file[,R] command line option with the “,R” runs the selected script. Please see “Scripting” on page 8 for a description of scripting.</p> <div style="border: 1px solid black; padding: 5px; margin-top: 10px;"> <p>Note</p> <p>You can use a “-” instead of a “/” as the command line switch.</p> </div>

Viewing the Test Groups

As you move the cursor bar up or down in the Test Module Selection window, the right hand screen changes to show the attributes, parameters, and the selected tests of the corresponding Test Group. The diamond mark indicates a module selected for testing.

The indicated attributes are characteristics of the selected test module that are used by the test programs to determine which tests to run or how to run selected tests. Attributes are also used to limit the allowable range of parameters (for example, – ending cylinder).

Parameters are values you select to establish the scope of tests. For example, you can select Extended Memory testing parameters and limit the testing to a specific range of test blocks by specifying the starting and ending memory block. This might be appropriate if prior experience indicates that problems are likely to exist in a specific area of memory. By selecting these limiting parameters, you reduce memory testing time.

Scripting

Scripting allows you to select specific groups of tests, testing parameters, and options. Your selection is saved for later use as a test *Script*. To set up a test script, first select all the appropriate test groups and specific tests you want to run from the Module Testing section under Diagnostics. You should also select appropriate testing parameters and options. See “Program Navigation” on page 6, for instructions to save a test script.

Changing Logical Unit Numbers

In some instances, you can have more than one logical unit number (LUN) for a particular module. LUNs represent individual devices within a test group or module. For example, you might have two diskette drives or two hard disk drives; or, you might have base and extended memory installed in the computer. This configuration might result in as many as two or three different LUNs in the Memory Test Group.

From either the Module Test Menu or the Test Group window, you can change to a different LUN (where applicable) by pressing the plus (+) key (next LUN), or the minus (-) key (previous LUN).

Test Group Specifications

In the upper-right-hand portion of the testing screen (or just the upper portion if you switched to an individual test group screen) are the specifications for the related test group.

Starting the QAPLus/PRO Diagnostics Diskette

Note

The "PC Server System Board Diagnostic Diskette" contains the QAPLus/PRO diagnostics for the PC Server 325 Type 8639.

1. Insert the QAPLus/PRO Diagnostics Diskette into drive A.
2. Power-on the computer.
3. When the QAPLus/PRO Diagnostics **Main Menu** is displayed, press **Ctrl+A**.
4. Select Diagnostics; then, press **Enter**.
5. Follow the instructions that appear on the screen. If an error is displayed, go to "Symptom-to-FRU Index" on page 165.

Module Testing Mode

If the test programs do not find a problem, or you want to perform in-depth testing, the Module Testing mode provides a method to run individual tests on a single module. For example, you can run an individual test for the diskette drive, or you can run groups of tests for several modules.

In the Module Testing mode, you can define how many times each test should run and how the test program should log the errors.

To start the Module Testing mode:

1. Start the diagnostics diskette. See "Starting the QAPLus/PRO Diagnostics Diskette."
2. Select **Diagnostic** from the Main Menu.
3. Select **Module Tests** from the next menu.
4. Use the up and down arrow keys (↑ and ↓) to move the highlight bar from one selection to the next.
5. Follow the instructions on the screen.

Note

As you scroll down the selection menu, the Test Group window to the right changes to correspond to the highlighted Module.

Running Selected Module Tests

To run all selected tests for a test group:

1. Use the up and down arrow keys (↑ and ↓) to move the cursor to your selection.
2. Press **Enter**.

Note

A "Diamond" appears next to your selection.

Running All Selected Modules

To run all selected test modules:

1. Use the down arrow key (↓) to move the cursor to the last choice, **Run All Selected Modules**.
2. Press **Enter**.

Note

A "Diamond" appears next to your selection.

Changing Selected Tests in Test Groups

To change selected tests in a Test Group:

1. In the Module Tests Menu, use the up and down arrow keys (↑ and ↓) to move the cursor to your selection.
2. Press **Tab** to move into the expanded Test Group window.
3. Scroll to the test you want to select or deselect.

Attention

Items indicated by a directly adjacent "*" (red text on color screens) are destructive tests.

4. Press the spacebar at the highlighted test to toggle between select (indicated by a "Diamond") and deselect.

Note

Pressing the first letter of a test does not activate the test, unlike menu operation.

5. Press **Esc** to return to the Test Group.
6. Press **Enter** to run the selected tests.

Running an Individual Test

To run an individual test:

1. From the expanded Test Group, use the up and down arrow keys (↑ and ↓) to move to the highlighted bar to the test you want to run.
2. Press **Enter** to run the test.

Note

The results of the test appear in the lower-right-hand Test Log window. Also, if you enabled Test Logging, the results are recorded in the Test Log.

3. When the test completes, press Esc to return to the Test Group Menu.

Stopping the Tests

To stop running a specific test or stop testing after you have started a test, press Esc while the test is running. The test pauses at the first possible opportunity, and the Skip/Abort Test Menu appears with the following options:

Option	Action
Continue	The test program begins testing where it left off.
Skip to next test	The test program skips the current test, but remaining tests for the selected Test Module continue.
Skip to next group	The test program skips the remaining tests in the current test group.
Abort all tests	The test program stops and returns to the previous menu.

QAPLus/PRO Diagnostics Control Keys

The following is a list of the QAPLus/PRO Diagnostics Control Keys, when used and a description of the diagnostics response.

Control Keys	When Used	Diagnostics Response
Ctrl+A	Main Menu	Allows you to select test from the sub menus that are highlighted with red letters. <div style="border: 1px solid black; padding: 5px; margin: 5px 0;"> <p>Attention</p> <p>If selected, these tests will erase the information stored on the diskette or hard disk drive.</p> </div>
Up and Down Arrow Keys	Main Menu Module Test Menu Test Group Menu	Highlights an item you want to select.

Control Keys	When Used	Diagnostics Response
Space Bar	Module Test Menu Test Group Menu	Adds a diamond to the left of the highlighted test. The test will run when Run All Selected is highlighted and the Enter key is pressed. Also removes the diamond to the left of the item. The test will not run when Run All Selected is highlighted and the Enter key is pressed.
Tab Key	Main Menu Module Test Menu	Selects the additional test for the menu you are in.
+/- Keys	Test Group Menu	Selects additional test. The LUN displayed on the top right Test Group Menu shows which test is selected and how and remain (example LUN 1 of 2).

PC Server 330 - Type 8640

Features	17
Diagnostics and Test Information	19
Additional Service Information	20
Bypassing an Unknown Power-on Password	21
Checkpoint Codes	22
Configuration	25
Configuration Overview	25
Configuration/Setup Utility	26
Starting the Configuration/Setup Utility Program	26
Using the Configuration/Setup Utility Main Menu System Summary	27
System Information	28
Product Data	28
PCI Routing	28
Devices and I/O Ports	28
Date and Time	29
Alarm/Wakeup Settings	30
Wake Up Timer	31
Wake Up on Ring	31
System Security	31
Using the Administrator Password Menu	32
Using the Power-on Password Menu	33
Start Options	34
Advanced Setup	35
Cache Control	35
ROM Shadowing	35
PCI Bus Control	35
Exiting from the Configuration/Setup Utility Program	35
Configuring Options	36
Using the EISA Configuration Diskette	36
Making Menu Selections	37
Recording EISA Configuration Settings	38
Starting the EISA Configuration Diskette	38
Using the Advanced Functions	39
Configuring EISA, ISA, and PCI Adapters	39
Configuring ISA or EISA Features and Options	39
Configuration Files	39
Device Drivers	40
Sample Applications	41
Configuring PCI Features and Options	41
Resolving Configuration Conflicts	41
Resolving Hardware Configuration Conflicts	42
Resolving Software Configuration Conflicts	42
Ethernet Controller	43
Ethernet Device Drivers	43
Ethernet Diagnostics	44
Backing Up the Ethernet Diagnostic Diskette	44
Starting the Ethernet Diagnostics	44
Ethernet Ports	44

Ethernet Controller Messages	45
Novell NetWare Server ODI Driver Messages	46
Novell NetWare DOS ODI Driver Messages	50
Novell NetWare OS/2 ODI Driver Messages	56
NDIS 2.01 Driver Messages	58
NDIS 3.0 Driver Messages	61
Packet Driver Messages	62
UNIX Messages	65
PC ServeRAID Adapter (FRU No. 06H9334)	69
Device Drivers	70
Administration and Monitoring Utilities	70
Monitoring the Adapter Status in a Local System	70
Monitoring Adapter Status from a Remote System	71
RAID Technology	71
Hard Disk Drive Capacities	72
Additional Storage Capacity	72
ServeRAID Configuration Program Screens	73
Starting the ServeRAID Configuration Program	75
The ServeRAID Adapter Main Menu	75
Viewing the ServeRAID Configuration	77
Performing Common Tasks	78
Creating a Disk Array	78
Defining Logical Drives	79
Defining a Hot-Spare Drive	83
Deleting a Disk Array	84
Deleting a Logical Drive	85
Redefining Space in an Array	86
Drive Maintenance	88
Obtaining Drive Status	88
Bay/Array Selection List	89
Logical Drive States	91
Defining the State of a Drive	91
Results of a Hard Disk Drive Failure	92
Logical and Hard Disk Drive Status Indications	93
Replacing a Faulty Drive	94
Rebuilding a Logical Drive	97
Resetting the Adapter Configuration	98
Viewing Configuration Changes	99
Synchronizing the Adapter Configuration	99
Running RAID Subsystem Diagnostic Tests	100
Additional Disk-Array Tasks	101
Backing Up The Disk-Array Configuration	101
Restoring the Disk-Array Configuration	102
Changing the Write Policy	102
Formatting Drives	104
Changing the RAID Parameters	105
Unattended Mode of Operation	107
F5	107
F6	107
F7	107
Changing the ServeRAID Adapter Parameters	107
Using the Mini-Configuration Program	109
Viewing the Adapter Status	109

Viewing Configuration Information	110
Using Advanced Configuration Functions	110
ServeRAID Adapter Messages	111
ServeRAID Adapter POST and Setup	
Messages	111
New Drive Installed	111
Configured Drives are Missing	112
Configured Drives Are Not in the	
Configured Location	112
New Adapter Installed in a Configured	
Server	113
ServeRAID Adapter Status and Error	
Messages	114
PC Server Advanced Systems Management	
Adapter (FRU No. 76H3240)	117
Installation Requirements	117
Resetting the Adapter and Clearing the	
Configuration	117
System and Adapter Configuration	118
Configuration Considerations:	118
EISA Configuration Utility:	119
Configuration/Setup Utility ISA Legacy	
Resources:	119
Manual I/O Address and Interrupt	
Assignment	120
Adapter Configuration:	120
Device Driver Installation	122
OS/2 Device Driver Installation	122
Windows NT Device Driver Installation	122
Novell NetWare Device Driver Installation	123
Adapter Cable to System Board Connections	124
PC Server 325	124
PC Server 330	124
PC Server 704	125
External Power Control Unit Operation and	
Indicators	126
Power Supply Voltages	128
Connector P1	128
Connector P2	128
Connector P3	128
Connector P4, P5, P6, P7, P8	128
SCSI IDs	129
SCSISelect Utility Program	130
Starting the SCSISelect Utility Program	130
SCSISelect Utility Program Options	130
Configure/View Host Adapter Settings	130
SCSI Disk Utilities	131
Performing a Low-Level Disk Format	131
When To Use the Low-Level Format	
Program	131
Starting the Low-Level Format Program	132
Saving Configuration Settings	132
Undetermined Problems	133
System/Processor Board Replacement	133

Symmetric Multiprocessors/Multiprocessing . . .	134
Locations	135
Air Baffle	136
Bezels (DASD)	137
Controls and Indicators (Non-Hot-Swap Server)	138
Controls and Indicators (Hot-Swap Server) . . .	139
Controls Indicators Descriptions	140
Card Guide	142
Cover (Top)	143
DASD Cage (3-Drive)	143
Door (Front)	144
Drives (Non-Hot-Swap)	144
Drives (Hot-Swap)	145
Light States	145
Expansion Slots	146
Front Bezel/Door Assembly	147
Input/Output Connectors	148
Internal Drive Bays (Non-Hot-Swap Servers) . .	150
Maximum Allowable Drive Sizes (Non-Hot-Swap Models)	150
Required Hardware for Drive Options	151
Internal Drive Bays (Hot-Swap Servers)	152
Maximum Allowable Drive Sizes (Hot-Swap Models)	152
Required Hardware for Drive Options	153
Memory Module	153
Operator Panel	154
Operator Panel Status Indicators	155
Optional Processor	157
Retention Bracket	158
Processor Board	159
Processor Board Jumpers	160
Operating Parameters Jumpers	160
Frequency Jumpers	161
System Board	162
System Board Jumper Settings	163
U-Bolt	164
Symptom-to-FRU Index	165
No Beep Symptoms	165
Beep Symptoms	165
Error Codes	169
Parts Listings (PC Server 330 - Type 8640)	173
System	174
Cables	177
Keyboards (101/102 Key)	178
Power Cords	179
Parts Listing (PC Server Advanced Systems Management Adapter)	180
Cables	180

Features

The features in the server vary according to the model. The following is a summary of the features that are available with the PC Server 330 - Type 8640.

Microprocessor

- Pentium Pro microprocessor
- 16 KB of level-1 cache
- 256 KB of level-2 cache (min.)
- Clock rate varies by model

Memory

- Standard: 32 MB (min.), expandable to 512 MB
- 60 ns, buffered Extended Data Out (EDO), Error Correcting Cod (ECC)
- Four dual inline memory-module sockets

Diskette Drives

- Up to two drives supported
- Standard: One 3.5-inch, 1.44 MB
- Optional (internal):
 - 3.5-inch, 1.44 MB
 - 3.5-inch, 2.88 MB

Hard Disk Drives

- Non-hot swap servers support up to six non-hot swap hard disk drives.
- Hot-swap servers support up to seven hard disk drives, six of them hot-swappable.

CD-ROM Drive

- Standard: SCSI

Keyboard and Auxiliary Device

(some models)

- Keyboard
- Mouse

Expansion Slots

Up to nine adapters can be installed.

- One dedicated PCI slot
- Four shared PCI/EISA slots
- Four dedicated EISA slots

Expansion Bays

- Six 5.25-inch drive bays (non-hot-swap server)
- One 5.25-inch and six hot-swap drive bays (hot-swap server)
- Three 3.5-inch drive bays
- The number of bays available for expansion varies by model.

Upgradable POST and BIOS

- POST/BIOS upgrades (when available) can update EEPROM on the system board

Security Features

- Bolt-down capability
- Door lock
- LogicLock security enabled
- Power-on and administrator passwords
- Selectable drive-startup
- Security-error indicator

Integrated Functions

- Two serial ports
- One infrared port
- One parallel port
- Mouse port
- Keyboard port
- SCSI-2 Ultra PCI controller
 - One external connector (16-bit)
 - One internal connector (16-bit)
- Ethernet Controller
 - 10BASE-T port
 - AUI port
- Video controller port compatible with:
 - Super video graphics array (SVGA)
 - Video graphics adapter (VGA)
 - Color graphics adapter (CGA)
 - 1 MB video memory (expandable to 2 MB)

Power Supply

- 350 W (110–220 V ac)
- Built-in overload and surge protection
- Automatic restart after a momentary loss of power

Diagnostics and Test Information

The following list contains problems and references for diagnosing a PC Server 330 Type 8640.

Notes

- The QAPLus/PRO diagnostic program recognizes the primary processor as LUN 1 and the secondary processor as LUN 2. During testing the program automatically tests LUN 1. You must select LUN 2 if you want the program to test the secondary processor.
- The type of DASD diagnostics required to test the hard disk controller (adapter) and drives is determined by the type of hard disk adapter installed in the computer.
- Always start with "General Checkout" on page 2.

Problem	Reference
Error Codes/Error Messages	"Symptom-to-FRU Index" on page 165
DASD Adapter Problems	For non-disk-array models, see "SCSISelect Utility Program" on page 130. For SCSI-2 Fast/Wide PCI-Bus RAID Adapter, see "PC ServeRAID Adapter (FRU No. 06H9334)" on page 69.
Memory	"General Checkout" on page 2.
Power Supply Voltages	"Power Supply Voltages" on page 128.
Miscellaneous	"General Checkout" on page 2.

Additional Service Information

The following additional service information is for the PC Server 330 Type 8640.

- “Bypassing an Unknown Power-on Password” on page 21.
- “Checkpoint Codes” on page 22.
- “Configuration” on page 25.
- “Ethernet Controller” on page 43.
- “Ethernet Device Drivers” on page 43.
- “Ethernet Diagnostics” on page 44.
- “Ethernet Ports” on page 44.
- “Ethernet Controller Messages” on page 45.
- “PC ServeRAID Adapter (FRU No. 06H9334)” on page 69.
- “PC Server Advanced Systems Management Adapter (FRU No. 76H3240)” on page 117.
- “Power Supply Voltages” on page 128.
- “SCSI IDs” on page 129.
- “SCSISelect Utility Program” on page 130.
- “Undetermined Problems” on page 133.
- “System/Processor Board Replacement” on page 133.
- “Symmetric Multiprocessors/Multiprocessing” on page 134.

Bypassing an Unknown Power-on Password

When a power-on password is set, the POST does not complete until the password is entered. If the power-on password is forgotten, you can regain access to the server in either of the following ways:

- Enter the administrator password at the power-on prompt. Start the Configuration/Setup utility programs and change the power-on password. See “Using the Power-on Password Menu” on page 33.
 - Change the position of the power-on password jumper. When you restart the server, POST proceeds without prompting for the password for this startup only. Start the Configuration/Setup Utility programs and set a new power-on password.
1. Locate the power-on password jumper (J12). If necessary, see “System Board” on page 162.
 2. Change the jumper's position.
 - a. Lift the jumper straight off the pin block.
 - b. Align the holes in the bottom of the jumper with the center pin and the pin that was not covered previously.
 - c. Slide the jumper over these pins. POST will bypass the power-on password the next time the server is powered-on.

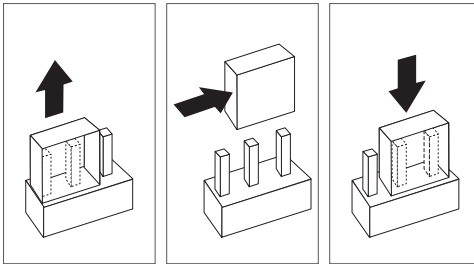

Note

Do not replace the jumper in its original position.

3. Replace the server cover and reconnect all external cables and power cords.
4. Use the Configuration/Setup utility programs to set a new power-on password.

Checkpoint Codes

During POST, the computer displays the status of the components being tested in the form of Checkpoint (CP) codes in the upper right-hand corner of the screen. The following is a list of the CP codes followed by the routine in process and the boot mode.

CP Code	Routine	Boot Mode
01	Test CPU Regs	Cold
02	Wait for RTC	Cold
04	Init Timer 0	Cold+Warm+SAD
05	Test DMA	Cold+Warm+SAD
06	Test Page Regs	Cold+Warm+SAD
07	Verify Refresh	Cold
08	Enable Parity	Cold+Warm+SAD
09	Clear first 64 K	Cold+Warm
0A	POST with Stack	Cold+Warm+SAD
0B	BIOS Shadow	Cold+Warm
0C	Phase 2 POST	Cold+Warm+SAD
0D	Init KBD Data	Cold+Warm+SAD
10	Test DMS Locations	Cold+Warm+SAD
12	Test PICs	Cold+Warm+SAD
14	Init Vector Table	Cold+Warm+SAD
15	Init Keyboard	Cold+Warm+SAD
16	Std CMOS Checksum_NS	Cold+Warm
17	Check Configuration	Cold+Warm
20	Test Timer Tick	Cold
21	Test Timer 2	Cold+Warm+SAD
23	Test RTC	Cold+Warm+SAD+SR
26	vpd_main	Cold+Warm
30	Shadow VPD	Cold+Warm
31	Save ID	Cold+Warm+SAD
32	Check P54C	Cold
33	Init Q Boot	Cold+Warm
34	Periph Config	Cold+Warm+SAD
35	Init Timeout Tables	Cold+Warm+SAD
36	Pos_Setup	Cold+Warm
37	TCPC	Cold+Warm
38	Find Serial Ports	Cold+Warm
39	Find Parallel Ports	Cold+Warm
3A	Enable Timer Init	Cold+Warm+SAD
3B	Clear Mem Size Error	Cold
3C	Mfg Boot Fork	Cold
3D	SignOn	Cold+Warm
3E	CPU Name	Cold+Warm
3F	CPU Speed	Cold+Warm
40	Enable Video	SAD

CP Code	Routine	Boot Mode
41	Size Memory Above 64 K	Cold+Warm
42	Password Not Entered	Cold
43	Test PS2 Mouse	Cold+Warm
44	Check for Mouse Buttons	Cold
45	Init KBD Flags	Cold+Warm+SAD
46	Test KBD	Cold+Warm
47	TCPC_Error	Cold+Warm
48	Mem Test Prompt	Cold+Warm
49	Test Memory	Cold+SR
4A	Clear EBDA	Warm
4B	Allocate EBDA	Cold+Warm+SR
4C	xfer_EBDA_vars	Cold+Warm+SR
4D	Set Warm Boot Flag	Warm
4E	Clear Speed Bits	Cold+Warm+SAD
4F	E_FLOB	Cold+Warm+SAD+SR
50	Enable System Interrupts	Cold+Warm+SAD+SR
51	C2Sec_Chk	Cold
52	Init KBD	Cold+Warm+SAD+SR
53	Check for NPX	Cold+Warm+SAD+SR
54	reset_hdctl	Cold+Warm+SAD+SR
55	FD_INIT	Cold+Warm+SAD+SR
56	Set Floppy Config	Cold+Warm+SAD+SR
57	Unlock Early	Cold
58	Init A20	Cold+Warm+SAD+SR
59	HD Setup	Cold+Warm+SAD+SR
5A	PnP_Assign Card Select Numbers	Cold+Warm+SR
5B	Verify CMOS Config	Cold+Warm+SR
5C	Clear Screen	Cold+Warm+SAD
5D	PnP_Assign Resources	Cold+Warm+SR
5E	Init Time of Day	Cold+Warm+SAD+SR
5F	Check for Locked KBD	Cold+Warm+SAD+SR
60	Init Enable NMI	Cold+Warm+SAD+SR
61	Set Boot Speed	Cold+Warm+SR
62	Set KBD LEDs	Cold+Warm+SAD
63	Check for Setup Hot Key	Cold+Warm
64	CSET_AFT_MTEST	Cold+Warm
65	CSET_AFT_CMCFG	Cold+Warm+SR
66	CSET_BFR_OPROM	Cold+Warm+SR
67	Phase 2 Exit Big Real	Cold+Warm+SAD+SR
90	Disable Video	Cold+Warm+SAD
91	Phase 1 Enter Big Real	Cold+Warm+SAD
93	Init Refresh	Cold+Warm
94	Init Chip_NS	Cold+Warm+SAD
95	CSET_Init	Cold+Warm+SAD
96	Disable Parity	Cold+Warm+SAD
97	Periph Init	Cold+Warm+SAD

CP Code	Routine	Boot Mode
98	Init RTC	Cold+Warm+SAD
99	Init Timer 2	Cold+Warm+SAD
9A	Setup GPIO Addr	Cold+Warm+SAD
9B	Post LED On_NS	Cold+Warm+SAD
9C	CPU1 LED On_NS	Cold+Warm+SAD
B0	Disable Appl 1 Local APIC	Cold+Warm
B3	Display SMP Sign On	Cold+Warm
B4	AP Cache Init	Cold+Warm
D1	Cache Init	Cold+Warm+SAD
D3	Cache Configure	Cold+Warm+SAD+SR
DA	EISA_Hook 6	Cold+Warm+SAD
DB	EISA Configure	Cold+Warm+SAD
DC	EISA Errors	Cold+Warm
E0	Reclaim On-board Option ROM Space	Cold+Warm+SAD+SR
EA	PCI Reset	Cold+Warm
EB	PCI Video	Cold+Warm
EC	PCI Configure	Cold+Warm+SR
ED	PCI IDE	Cold+Warm
EE	PCI SCSI	Cold+Warm

Configuration

Note

The SCSISelect utility program does not configure the drives in an array. For Disk Array configuration information see "PC ServeRAID Adapter (FRU No. 06H9334)" on page 69.

The Configuration/Setup utility programs are part of the *basic input/output system (BIOS)* that is shipped with the server. Use these programs to set the system date and time, define input and output device parameters, and define system security.

The PC Server System Board Diagnostic Diskette that is shipped with the server provides additional configuration and diagnostic support for the system board, disk drives, and other system components.

The built-in SCSISelect utility program configures the SCSI devices installed in the server. You can use SCSISelect to change default values, resolve configuration conflicts, and perform a low-level format on a SCSI hard disk drive.

Configuration Overview: Configuration is the process used to allocate resources to organize and interconnect hardware devices and software programs. The steps required to configure the server depend on the number and types of devices and programs installed.

The server supports adapters and devices that comply with any of the following standards:

- Peripheral Component Interconnect (PCI)
- Extended Industry Standard Architecture (EISA)
- Industry Standard Architecture (ISA)
- Small Computer System Interface (SCSI)

In general, the greater the number and variety of hardware devices and software programs installed in the server, the more interaction required with the server and the devices to correctly configure the system.

The server is shipped with the following hardware configuration utility programs:

- The built-in Configuration/Setup utility program lets you configure system board functions, such as serial and parallel port assignments, change interrupt requests settings, and the startup sequence for drives that you install. You also can use this utility program to set passwords for starting up the server and accessing the Configuration/Setup utility program.
- The EISA Configuration utility program on the PC Server 330 - Type 8640 PC Server 330 EISA

Configuration Diskette, lets you configure EISA and ISA adapters.

- The built-in SCSISelect utility program lets you configure the SCSI devices that are install in the server. You can use SCSISelect to change default values, resolve configuration conflicts, and perform a low-level format on a SCSI hard disk drive.
- Use the utility programs on the PC Server Utilities Diskette to back up and restore the CMOS and NVRAM configuration data.

Before installing a new device or program, read the documentation that were shipped with it. Reading the instructions helps you determine the steps required for installation and configuration. The following actions are typically, but not always, required to configure the server.

1. Run the Configuration/Setup utility program and record the current configuration settings.
2. Set jumpers or switches on the server's system board.
3. Set jumpers or switches on the device.
See the device installation instructions.
4. Install the device in the server.
5. Install software programs.
See the installation instructions that were shipped with the software.
6. Resolve configuration conflicts.
See "Resolving Configuration Conflicts" on page 41.

Configuration/Setup Utility: For most configurations, the server will operate using the default system settings. You need to change the settings only to resolve configuration conflicts or to enable or change device functions (for example, defining diskette types).

When you want or need to change the default settings, the Configuration/Setup utility program provides a convenient way to display and change the settings.

After you run and exit the Configuration/Setup utility program, configuration information is stored in non-volatile RAM (NVRAM). The configuration information remains available for the next system startup while the server is powered off.

Always run the Configuration/Setup utility program if you have added or removed any hardware option, or if you receive an error message instructing you to do so. Also, record the current settings before making any changes.

Starting the Configuration/Setup Utility

Program: To start the Configuration/Setup utility program:

1. Power-on the server and watch the screen.

2. When the message Press F1 for Configuration/Setup appears, press **F1**.

The Configuration/Setup utility Main Menu appears. For more information about the menus, see “Using the Configuration/Setup Utility Main Menu.”

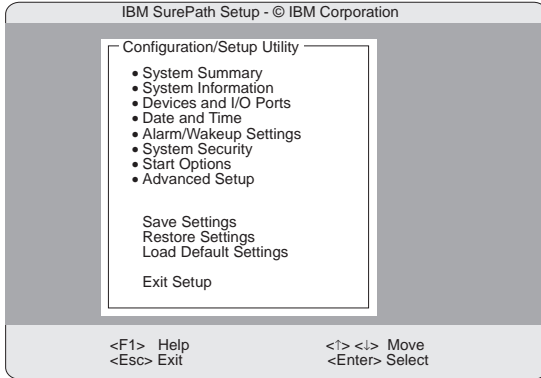

Note

Some menus might differ slightly, depending on the BIOS version shipped with the server.

Using the Configuration/Setup Utility Main Menu:

The Configuration/Setup utility program Main Menu lets you select settings you want to change.

Pressing **F1** displays Help information for a selected menu item.

Note

If you enter only the power-on password and an administrator (supervisor-level) password is also set, a limited version of the menu appears.

To change configuration settings:

1. Use the Up Arrow (↑) or Down Arrow (↓) keys to select the menu item for the configuration setting you want to change. Selected items are highlighted. Press Enter.
2. Select the configuration setting you want to change. Use the Page Up (PgUp) and Page Down (PgDn) keys to scroll through the menu, if needed.
3. Use the Right Arrow (→) or Left Arrow (←) keys to select the appropriate setting for the selected item.
4. Repeat Steps 1 through 3 for each setting you want to change. Press ESC to return to the Configuration/Setup Main Menu.

5. After making changes, you can:
 - Select **Save Settings** to save the selected changes.
 - Select **Restore Settings** to delete the changes and restore the previous settings.
 - Select **Load Default Settings** to cancel the changes and restore the factory settings.
6. To exit from the Main Menu, select **Exit Setup**. The system prompts you to confirm your choice. You can save your changes and exit, exit without saving your changes, or return to the Main Menu.

System Summary: Select this choice to display configuration information, including the type and speed of the microprocessor and amount of memory.

Changes that you make to configuration settings appear on this summary screen. You cannot edit the fields.

The System Summary choice appears on the full Configuration/Setup menu and on the limited Configuration/Setup menu.

System Information: Select this choice to display information about the PC Server 330 - Type 8640, and to view the interrupt request (IRQ) settings for the SCSI and Ethernet controllers on the system board, and other PCI adapters installed.

Changes that you make on other menus might appear on this summary screen. You cannot edit any fields.

The System Information choice appears only on the full Configuration/Setup menu.

Product Data: Select this choice to view system information such as the machine type and model, the system serial number, the system board identifier, and the revision level or issue date of the flash electronically erasable programmable ROM (EEPROM) and BIOS.

PCI Routing: Select this choice to view the settings for interrupt requests for PCI adapters. In addition, you can view the interrupt requests for the Ethernet and SCSI controllers on the system board.

Devices and I/O Ports: Software recognizes ports from their port assignments. Each port must have a unique port assignment. The *Setup* normally handles this, but you might have special hardware or software that requires you to change these assignments.

Select the Devices and I/O Ports choice to view or change the assignments for devices and input/output ports.

Notes

1. The infrared connector and Serial B connector share a single port assignment. By default, the infrared connector is configured as **Disabled**.
2. The serial, parallel, and infrared ports, and the diskette drive must have the same configuration in the Configuration/Setup utility programs and the EISA Configuration Diskette. See "Using the EISA Configuration Diskette" on page 36 for more information.
3. When you configure the parallel port as bidirectional, use an IEEE 1284-compliant cable. The maximum length of the cable must not exceed 3 meters (9.8 feet).

You can add serial ports by installing a serial adapter in an expansion slot. See the documentation that was shipped with the serial adapter for information about port assignments.

The parallel port can be configured as *bidirectional*, that is, data can be both read from and written to a device. In bidirectional mode, the server supports Extended Capabilities Port (ECP) and Enhanced Parallel Port (EPP).

To display or change the assignments for devices, or the infrared, serial, or parallel ports:

1. Power-on the system. When the **F1** prompt appears, press **F1**. The Configuration/Setup Utility menu appears.
2. Select **Devices and I/O Ports**.
3. Select a device or port; use the Left Arrow (←) and Right Arrow (→) keys to advance through the settings available.

The Devices and I/O Ports choice appears only on the full Configuration/Setup menu.

Date and Time: Select this choice to set the system date and time.

The system time is in a 24-hour format:
hour/minute/second.

The system date is in standard format for your country, for example, in the United States, the format is **MM/DD/YY** (Month/Day/Year).

Select **Date and Time**, then use the Left Arrow (←) and Right Arrow (→) keys to advance through each data field. Type the new information; the system saves the information as you type it.

The **Date and Time** choice appears only on the full Configuration/Setup menu.

Alarm/Wakeup Settings:

The server can be started manually or at a predefined event. The server enters one of the following states.

Attended mode	This is the “on” state that occurs when you press the power switch from the Standby or Unattended mode. The Power-On Light comes on whenever the server is on.
Unattended mode	The server starts at a specified date and time, or when it receives a signal from either serial port. When the server powers on in the Unattended mode, the Unattended Power-On light and the Power-On Light come on.
Standby mode	<p>The server is powered down. The automatic restart feature, which enables the server to restart following a momentary power loss, means that the server is never completely powered off.</p> <p>The server must be in the Standby mode (off) for the Alarm/Wakeup Settings features that you define to take effect.</p>

Select the **Alarm/Wakeup Settings** choice to enable and disable features that power-on the server automatically.

The result of pressing the power switch varies, depending on which mode the server is in. To toggle from:

- Standby mode to Attended mode, press and release power switch.
- Attended mode to Standby mode, press the power switch in slowly just until the power-on light goes out and then immediately release the switch.
- Unattended mode to Attended mode, press and release the power switch. The server restarts in Attended mode.

Notes

1. For proper operation of the **Alarm/Wakeup Settings** options, set the **Password Prompt** choice to **Off**.
2. Set the Wakeup features immediately before you plan to power-off the server. The server locks and cannot be used after you exit, saving the settings. When the server restarts, in either Attended or Unattended mode, the Wakeup features return to the default, disabled, setting.
3. When both features are enabled, the server starts when the first condition (time or signal) occurs.

The **Alarm/Wakeup Settings** choice appears only on the full Configuration/Setup menu.

Wake Up Timer: With this option, you can specify a date and time at which the server will be powered on automatically.

To set the Unattended mode, select **Alarm/Wakeup Settings**, then select **Wakeup Timer**. Then, set or change the settings. Select **Wakeup Date** to specify a date up to 31 days away. Select **Wakeup Time** to specify a time, using a 24-hour clock format.

Wake Up on Ring: When this option is enabled, the server powers on automatically when it receives a signal from Serial port A or B.

System Security: To control access to your server, you can implement the security features described in the *User's Reference*. These features include two levels of password protection and restricted diskette access.

The **System Security** choice appears only on the full Configuration/Setup menu.

To set, change, or delete a password:

1. Select **System Security**.
2. Select the password that you want to change.

The **System Security** choice appears only on the full Configuration/Setup menu.

After you set a power-on or administrator password, you must enter the password when you turn on the server. (The passwords do not appear on the screen as you type them.)

Type of Password	Results
No password set	<ul style="list-style-type: none"> No password required to start system. User can access all choices on the <i>Setup</i> utility program menu.
Power-on password only	<ul style="list-style-type: none"> User must enter password to complete the system startup. Power-on password provides access to all choices on the <i>Setup</i> utility program menu.
Administrator password	<ul style="list-style-type: none"> User must enter password to complete the system startup. Administrator password provides access to all choices on the <i>Setup</i> utility program menu.
Administrator <i>and</i> power-on password	<ul style="list-style-type: none"> User can enter either password to complete the system startup. <ul style="list-style-type: none"> Administrator password provides access to all choices on the <i>Setup</i> utility program menu. You can set, change, or delete both the administrator and power-on passwords, and allow a power-on password to be changed by the user. Power-on password provides access to a limited set of choices on the <i>Setup</i> utility program menu. This might include changing or deleting the power-on password.

Using the Administrator Password Menu: The administrator password (sometimes called a supervisor-level password) controls access to some features of the server, including the Configuration/Setup utility program.

Attention

If an administrator password is set and then forgotten, it cannot be overridden or removed. The system board must be replaced.

To set an administrator password:

1. Select **Administrator Password** on the System Security menu; then press **Enter**.
The **Administrator Password** menu appears.
2. Type the password in the **Enter Administrator Password** data field.

A password can contain any combination of up to seven alphanumeric characters (A–Z, a–z, and 0–9). Keep a record of the password in a secure place.

3. Move the cursor to the **Enter Administrator Password Again** data field and type the password again.
4. Select **Set or Change Administrator Password** to save the new password; then press **Enter**. The password becomes effective immediately.

Note

A message appears if the two passwords do not match. If this happens, press **Esc** to cancel the request and return to the System Security menu.

To delete an administrator password:

1. Select **Administrator Password** on the System Security menu; then press **Enter**.
Following a warning, the **Administrator Password** menu appears.
2. Select **Delete Administrator Password**; then press **Enter**.
3. A confirmation window appears. Press **Enter** to delete the administrator password. Press **Esc** to return to the System Security menu.

To enable a user to change the power-on password:

1. Select **Administrator Password** on the System Security menu; then press **Enter**.
The **Administrator Password** screen appears.
2. Select **Power-on password changeable by user**. Press the Left Arrow (←) or Right Arrow (→) key to toggle the entry to **Yes**.

When this choice is enabled, **System Security** appears on the limited Configuration/Setup menu. The System Security menu contains the **Power-on Password** choice.

Using the Power-on Password Menu: When a power-on password is set, you must enter a password each time you start the system.

To set a power-on password:

1. Select **Power-on Password** on the System Security menu; then press **Enter**.
The **Power-on Password** menu appears.
2. Type the password in the **Enter Power-on password** data field.
You can use any combination of up to seven characters (A–Z, a–z, and 0–9) for the power-on password. Keep a record of the password in a secure place.
3. Move the cursor to the **Enter Power-on Password Again** data field and type the password again.
4. Select **Set or Change Power-on Password** to save the new password; then press **Enter**.

Note

A message appears if the two passwords do not match. If this happens, press **Esc** to cancel the request and return to the System Security menu.

If you forget the power-on password, and an administrator password has been set, use the administrator password at the power-on prompt; then start the Configuration/Setup Utility program and change the power-on password. If no administrator password has been set, you can bypass the power-on password prompt during POST and set a new password. For instructions, see "Bypassing an Unknown Power-on Password" on page 21.

To delete a power-on password:

1. Select **Power-on Password** on the System Security menu; then press **Enter**.
The **Power-on Password** menu appears.
2. Select **Delete Power-on Password**; then press **Enter**.
3. A confirmation window appears. Press **Enter** to delete the power-on password. Press **Esc** to cancel the request and return to the System Security menu.

To turn off the prompt for the power-on password:

1. Select **Power-on Password** on the System Security menu; then press **Enter**.
The **Power-on Password** screen appears.
2. Select **Password Prompt**. Press the Left Arrow (←) key or Right Arrow (→) key to toggle the entry to **Off**.

Start Options: Start options take effect when you start the server.

You can select keyboard operating characteristics, such as the keyboard speed. You can also specify whether the keyboard number lock starts on or off.

The server uses a startup sequence to determine the device from which the operating system loads. For example, you can define a startup sequence that checks for a startable diskette in the primary diskette drive, then checks the hard disk drive in bay 1, and then checks a network adapter.

You can enable a virus-detection test that checks for changes in the master boot record at start up. You can also choose to run POST in an enhanced mode or a quick mode.

Select **Start Options**, then use the Left Arrow (←) and Right Arrow (→) keys to advance through each data field.

The **Start Options** choice appears only on the full Configuration/Setup menu.

Advanced Setup: Select **Advanced Setup** to change values for advanced hardware features such as cache control and ROM shadowing.

A warning message displays above the choices on this menu, to alert you that the system may malfunction if these options are configured incorrectly. Follow the instructions on the screen carefully.

Use the Left Arrow (←) and Right Arrow (→) keys to advance through each data field.

The **Advanced Setup** choice appears only on the full Configuration/Setup menu.

Cache Control: Select this choice to enable or disable the microprocessor cache state. In addition, you can define the microprocessor cache type as write-back or write-through.

You can also enable or disable video BIOS caching, and define buffers for video and option ROM caching.

ROM Shadowing: Select this choice to enable ROM shadowing in specified areas. When these areas are enabled, the contents can be cached, using **Cache Control** option.

PCI Bus Control: Select this choice to manually assign the interrupt requests (IRQs) for PCI adapters installed in the server, and for the SCSI and Ethernet controllers on the system board.

You can also enable the generation of a non-maskable interrupt (NMI) when a PIC data parity error occurs.

If you install an adapter that requires a memory address in the C8000 to CFFFF (hexadecimal) range, you must change the memory address of the server's SCSI ROM. Select **SCSI ROM address** to assign an alternate address.

To enable or disable the CPU to PCI write posting, select **CPU-PCI Write Buffers**.

Exiting from the Configuration/Setup Utility

Program: Select **Exit Setup** to exit from the Configuration/Setup utility programs Main Menu; then, press Enter.

The system prompts you to confirm your choice. If you want to make additional changes, you can return to the Configuration/Setup Utility. If you made any changes and did not save them with the **Save Settings** choice, the system prompts you to save or discard the changes before exiting the Configuration/Setup utility programs.

When you finish configuring the server, you can save the CMOS and NVRAM configuration data to a diskette. This is useful in case you have to clear CMOS or replace the system board, and you want to restore the existing configuration.

Refer to the README file on the PC Server Utilities Diskette for specific procedures on backing up and restoring CMOS and NVRAM configuration data.

Configuring Options: Before installing a new device or program, read the documentation that was shipped with it. Reading the instructions helps you to determine the steps that are required for installation and configuration. The following list provides a preview of the actions that might be required to configure the server.

1. Run the Configuration/Setup utility program and record the current configuration settings.
See "Starting the Configuration/Setup Utility Program" on page 26.
2. Start the EISA Configuration Diskette and:
 - a. Record the current settings.
 - b. Install configuration files (.CFG) and overlay files (.OVL).

Note

If a .CFG file did not come with the adapter, see "Configuration Files" on page 39.

See "Recording EISA Configuration Settings" on page 38 and "Starting the EISA Configuration Diskette" on page 38.

3. Set jumpers or switches on the server system board.
4. Set jumpers or switches on the device.

See the instructions that was shipped with the adapter.

5. Install the adapter in the server.
6. Install software programs.

See the installation instructions that was shipped with the software.

7. Resolve configuration conflicts.

See "Resolving Configuration Conflicts" on page 41.

Using the EISA Configuration Diskette: You must use the EISA Configuration Diskette anytime you want to add, move, or remove EISA or ISA adapters. In addition, you might need to use the diskette to resolve configuration conflicts.

Also, if you disable the serial, parallel, infrared, or diskette drive in the Configuration/Setup utility programs, you might need to run the EISA Configuration Diskette, and make the same change. Refer to the README file on the EISA Configuration Diskette for more information.

Each time you use the EISA Configuration Diskette to configure the server, the configuration information is saved in a *System Configuration Information (SCI)* file and in the NVRAM configuration. Only devices that are installed and configure correctly appear on the EISA Configuration screens.

Making Menu Selections: When you start the backup copy of the EISA Configuration Diskette, an introductory screen appears. Press **Y**. The Main Menu, **Steps in configuring your computer**, appears. The EISA Configuration program main menu contains five steps:

1. **Important EISA configuration information:** This step provides information about the differences between the ISA configuration process and the EISA configuration process.
2. **Add or remove boards:** If the server is configured correctly, this step provides a list of the devices installed in the expansion slots. The **Add** choice allows you to add ISA devices to the configuration. If EISA adapters are installed in the server, and you have not copied the *.CFG* file to the EISA Configuration Diskette, you are prompted to insert the adapter configuration diskette into the diskette drive. The *.CFG* file is copied to the diskette. If the adapter *.CFG* file is copied to the EISA Configuration Diskette before starting the diskette, and the adapter is installed in the server, EISA devices are added automatically.
3. **View or edit details:** After adding EISA or ISA adapters in Step 2, use the **Edit** selection of this step to configure them. Use the **Edit Resources** selection of this step for complex configurations. If you change a setting in this step, you might have to change a switch or jumper setting on the system board or on a device.

Note

You can view the settings for PCI devices, but you cannot change them through the EISA Configuration utility program. To change settings for PCI devices, see "PCI Bus Control" on page 35.

4. **Examine switches or print report:** After Steps 1 and 2 have been completed correctly, this step displays the correct switch and jumper settings for the installed devices that have switches and jumpers. Also, you can choose to print a system configuration report.
5. **Save and exit:** This step allows you to save the configuration or to discard the changes before you exit from the program.

Use the Up Arrow (↑) or Down Arrow (↓) key to highlight a selection; then press **Enter** to make the selection. To help you track your progress, a checkmark (√) appears on the main menu next to the completed steps.

You can access help information through:

- Help windows, which remain active.
- Information windows, which appear automatically as a result of some configuration activities.
- The Help=F1 prompt, which allows you to access the Help Menu for screens displaying the prompt. To remove the Help Menu, press **Esc**.

Recording EISA Configuration Settings:

Record the configuration settings you made in Step 3, **View or edit details** and Step 4, **Examine switches or print report** on a separate sheet and store it in a safe place for future reference. If a printer is attached to the server, you can use the **Print Screen** key to print these settings. The settings are helpful when installing additional options, or if the system needs to be serviced. Also, record the new settings each time you make changes.

Starting the EISA Configuration Diskette:

To start the EISA Configuration Diskette:

1. Insert the backup copy of the EISA Configuration Diskette into the diskette drive.
2. Power-on the server, or if it is already on, shut down the operating system and restart the server.
3. When the first screen appears, press **Y**. Follow the instructions on the screen until the Main Menu, **Steps in configuring your computer**, appears.
4. Use the Up Arrow (↑) or Down Arrow (↓) key to advance through the items on the screen. Use the Tab key to select choices on the bottom of the screen. Press the Esc key to return to a previous menu.
5. Press **Enter** to make a selection.
6. Follow the instructions on the screen to view or change (edit) the configuration information.

Note

Adapters that are installed in the server appear automatically on the EISA Configuration screens *after* you copy the adapter configuration file (file with an extension of .CFG) to the EISA Configuration Diskette. If you want to manually add an EISA adapter that you have not yet installed in the server, add it using Step 2 from the menu. (see "Making Menu Selections" on page 37). To configure ISA adapters, follow the instructions on the screen.

Using the Advanced Functions: Locking an ISA adapter reserves the selected resources and prevents the system from using them to resolve resource conflicts. Use the **Advanced** function to *lock* ISA boards. An exclamation mark (!) appears next to locked adapters.

To use the Advanced functions:

1. Start the backup copy of the EISA Configuration Diskette (see "Starting the EISA Configuration Diskette" on page 38).
2. At the main menu, select Step 3, **View or edit details**.
3. Press **F7**. The Advanced functions screen appears.
4. Follow the instructions on the screen to:
 - Lock or unlock boards
 - View additional system information
 - Set verification mode
 - Maintain SCI files

Configuring EISA, ISA, and PCI Adapters:

Always use the backup copy of the EISA Configuration Diskette when assigning interrupts for EISA and ISA adapters. You cannot assign an EISA or ISA adapter the same interrupt that you have assigned to a PCI adapter. This is because the PC Server 330 - Type 8640 does not support interrupt sharing among PCI, EISA, and ISA adapters.

If a situation occurs where you need an additional interrupt, you can use an interrupt from another function that you might not need, such as COM2 (Interrupt 3) or parallel port (Interrupt 5 or 7).

Configuring ISA or EISA Features and

Options: Some ISA and most EISA devices come with option diskettes. These diskettes can contain any or all of the following types of information:

- Configuration files (.CFG)
- Device drivers
- Sample applications (mini-applications)

Configuration Files: A configuration file is required to configure the server for ISA or EISA adapters. You have to copy this configuration file, which has a file-name extension of *.CFG*, from the device diskette to the EISA Configuration Diskette before installing the device in the server. The configuration file reserves the system resources that the adapter needs to function properly.

Some ISA adapters come with a diskette that contains the *.CFG* file for the adapter. If you want to install ISA adapters that do not come with their own *.CFG* files, you must create a *.CFG* file for each adapter.

To create a unique *.CFG* file for an ISA adapter:

1. Insert the IBM PC Server EISA Configuration Diskette into diskette drive A.
2. Start the configuration utility program. See "Starting the Configuration/Setup Utility Program" on page 26 if necessary.
3. At the main menu, select Step 2, **Add or remove boards**.
4. At the next menu, select the slot in which you installed the adapter.
5. At the next screen, select **OK**.
6. At the next screen, press **F5**; then, select **Create .CFG file**.
7. Press **Enter**.
8. At the Create a Board .CFG File screen, type in the adapter manufacturer and description (for example, IBM Token Ring); then press **Enter**.
9. Refer to the adapter documentation for information about specific configuration parameters (such as IRQ or DMA channel) required for the adapter. Then, follow the instructions on the screen to enter the appropriate parameters on the menu.

Note

Normally, ISA adapters do not use every parameter. Most adapters require only a port address.

10. The controllers on the server requires specific memory and I/O address assignments to function properly. To avoid configuration conflicts, do not assign the following memory and I/O addresses to other adapters or:
A0000 – C7FFF
11. After you type in all of the appropriate parameters, press **F10**.
12. At the next screen, carefully verify that the information is correct; then, press **Enter**.
13. At the Add Confirmation window, press **Enter** again.
14. In the next window (add), press **Enter**.
The adapter description appears in the selected slot.
15. Verify the installation; then press **F10**.
16. At the next menu, select **Save and exit the configuration utility**.

Device Drivers: Device drivers are programs designed to support a specific type of hardware device. They provide instructions that enable the computer to interact with the device, or to take advantage of a device's special feature. The device driver might come with the operating system, the application program, or on the option diskette. Not all devices require device drivers. Refer to the documentation that was shipped with the option for additional information.

Sample Applications: Some optional devices provide small applications or sampler files. These applications demonstrate the capabilities of the device and serve as software examples for programming the device. Refer to the documentation that was shipped with the option for additional information.

Configuring PCI Features and Options: PCI devices automatically communicate with the server configuration information. This usually results in automatic configuration of a PCI device. If a conflict does occur, see “Resolving Configuration Conflicts.”

Multiple-function PCI adapters use more than one interrupt. When you install one of these adapters, review the IRQ assignments in the Configuration/Setup utility programs (see “PCI Bus Control” on page 35). Verify that the IRQ assignments are correct.

The PC Server 330 uses a rotational interrupt technique to configure PCI adapters. This technique enables you to install a variety of PCI adapters that currently do not support sharing of PCI interrupts. For information on manually overriding the interrupt, see “PCI Bus Control” on page 35.

Resolving Configuration Conflicts: The resources used by the server consist of IRQs, DMA, I/O ports addresses, and memory. This information is useful when a resource configuration conflict occurs.

Conflicts in the configuration occur if:

- A device is installed that requires the same resource as another device. (For example, a conflict occurs when two adapters try to write to the same address space.)
- A device resource is changed (for example, changing jumper settings).
- A device function is changed (for example, assigning COM1 to two serial ports).
- A software program is installed that requires the same resource as a hardware device.

The steps required to resolve a configuration error are determined by the number and variety of hardware devices and software programs installed. If a hardware configuration error is detected, a *configuration error* message appears after the server completes POST and before the operating system is loaded. You can bypass the error by pressing **Esc** while the error message is displayed.

The Configuration/Setup utility program configures the system hardware and PCI interrupt requests. The program does not consider the requirements of the operating system or the application programs. See “Resolving

Software Configuration Conflicts” on page 42 for additional information.

Resolving Hardware Configuration

Conflicts: Use the following information to help resolve hardware configuration conflicts:

1. Run the Configuration/Setup utility program to view and change resources used by the system board functions and the PCI interrupt requests (IRQs), if necessary. Record the current settings before making any changes. (See “Starting the Configuration/Setup Utility Program” on page 26 for instructions.)
2. Determine which adapter or device is causing the error.
3. Change configuration resource allocations. Use the EISA Configuration program.
4. Change adapter jumpers or switches. Jumpers and switches define the system resources a device uses. If the settings are incorrect or set to use a resource that cannot be shared, a conflict occurs and the device will remain deactivated by the configuration program.
5. Change system board jumpers or switches. Refer to the system-board diagram inside your server.
6. Remove the device or adapter. Some configurations are not supported.
7. Assign EISA memory addresses starting with DFFFF (in hexadecimal), and work downward to address C8000 (in hexadecimal). PCI devices are automatically assigned memory addresses starting from C8000 (hexadecimal) working upward.

Resolving Software Configuration

Conflicts: The memory-address space and IRQs used by some hardware options might conflict with addresses defined for use through application programs or the EMS. (EMS is used only with DOS.)

If a conflict exists, one or more of the following conditions might exist:

- The system cannot load the operating system.
- The system does not work.
- An application program does not operate, or it returns an error.
- Screen messages indicate a conflict exists.

To resolve conflicts, you can change the software or hardware configuration.

Note

Start the Configuration/Setup utility program to view the addresses used by your system board functions.

The best way to resolve memory-address conflicts is to change the addresses used by the application program or the device driver.

If a device driver is causing a memory-address conflict, refer to the operating-system documentation or the documentation supplied with the device drivers.

Ethernet Controller

The Ethernet controller on the system board provides an efficient, high-speed interface to a 10-Mbps Ethernet network, with automatic configuration.

The controller provides full-duplex (FDX) operation.

The controller also provides an automatic sensing function. The server automatically detects which of the two Ethernet ports is connected to the network, and then uses that port for communication. This function, always active, eliminates the need for a media type parameter and facilitates changing from one media type to another.

Note

Before installing an IBM PC Ethernet adapter, be sure to run the Ethernet diagnostics and record the server's Ethernet configuration information.

Ethernet Device Drivers

The following is a list of Ethernet device drivers and the directory/path in which they are located for the operating systems supported by the PC Server 330 - Type 8641. The device drivers are located on three diskettes labeled 1, 2, and 3. These diskettes are supplied with the server.

Note

The device driver names are printed in **bold type**.

- Disk 1
 - NDIS 2.0.1 Driver (DOS, OS/2)
 - A:\MSLANMAN.DOS\DRIVERS\ETHERNET\PCNTND**PCNTND.DOS**
 - A:\MSLANMAN.OS2\DRIVERS\ETHERNET\PCNTND**PCNTND.OS2**
 - A:\LANSRV\R**PCNTND.OS2**
 - ODI Driver (DOS, OS/2, Server)
 - A:\NOVELL\SERVER\3.1X**PCNTNW.LAN**
 - A:\NOVELL\SERVER\4.X**PCNTNW.LAN**
 - Novell Support files
 - A:\NOVELL\WKSTN\DOSODI**PCNTNW.COM**
 - A:\NOVELL\WKSTN\OS2ODI**PCNTNW.OS2**
 - ODI LAPP Driver (DOS)
 - A:\LAPP\DOSODI**PCLAPP.COM**

- NDIS 3.x for Windows NT 3.51
 - A:\WINNT351\AMDPCN.SYS
- SCO UNIX Open Server 5.0 MDI driver
 - Driver support is built into SCO UNIX 5.0.
- Unixware 2.0 DLPI driver
 - Driver support is built into UNIXWARE 2.x.
- Disk 2
 - DOS Client for IBM LAN Server
 - A:\IBMADOS\PCNTND.DOS
 - A:\IBMLSP\PCNTND.DOS
 - Packet Driver
 - A:\PKTDRVR\PCNTPK.COM
- Disk 3
 - Sun Solaris Driver (for v2.4)
 - This diskette is Unix PkgAdd format. the driver's name extension is pcnt.

Ethernet Diagnostics

You must use the Ethernet Diagnostic Diskette to perform diagnostic tests on the integrated Ethernet controller. This diagnostic diskette includes the LANAIID utility program.

Backing Up the Ethernet Diagnostic

Diskette: Use an operating system command, such as the DOS DISKCOPY command, to make a *complete* backup copy of the IBM PC Server PCI Ethernet diagnostic diskette. Using the backup copy can prevent damage to the original diskette. Your operating system documentation provides information on backing up diskettes.

Starting the Ethernet Diagnostics:

To start the Ethernet Diagnostic Diskette:

1. Insert the backup copy of the Ethernet diagnostic diskette into the diskette drive.
2. Power-on the server, or if it is already on, shut down the operating system and restart the server.
3. Type **/diags**; then, press **Enter**.
4. Follow the instructions on the screen.
5. When the diagnostic tests are complete, remove the diskette from the diskette drive; then, restart the server.

Ethernet Ports

The PC Server 330 Type 8640 has Ethernet connectors for 10Base-T or Attachment Unit Interface (AUI) devices. The controller automatically detects which port is connected to the network, and then uses that port for communication.

Notes

- If the server comes with an Ethernet interface cable, it must be installed to comply with FCC requirements.
- The cables used in a 10BASE-T link segment do not require grounding. However, all of the devices connected to the cables must be grounded.

To connect the 10Base-T port to a 10Base-T port on a repeater, use an unshielded twisted-pair (UTP) cable with RJ-45 connectors at both ends. Use a straight-through UTP cable when connecting to a crossover port (also called MDI-X port), and use crossover cables to connect to a repeater that is not a crossover port (also known as a MDI port).

To connect the AUI port to a 10Base-5, 10Base-2, or 10Base-F segment, use an AUI cable.

Ethernet Controller Messages

The integrated Ethernet controller might display messages from the following drivers:

- Novell NetWare Server ODI
- Novell NetWare Server DOS ODI
- Novell NetWare Server OS/2 ODI
- NDIS Adapter for level 2.01
- NDIS Adapter for level 3.0
- Packet Driver
- SCO UNIX LLI, UnixWare DLPI, and SunSoft Solaris

Novell NetWare Server ODI Driver

Messages: This following error messages are for the Novell NetWare server ODI driver. The explanation and recommended action are included with each message.

PCNTNW-NW-026 The MSM is unable to parse a required custom keyword.

Explanation: The user entered an incorrect parameter keyword.

Action: Enter the keyword correctly. Then, reload the driver.

PCNTNW-NW-054 The board did not respond to the initialization command.

Explanation: The board did not respond when the driver tried to initialize it.

Action: Do the following:

1. Verify that the Ethernet jumper on the system board is set to the default, enabled position.
 2. Go to "General Checkout" on page 2.
-

PCNTNW-NW-58 The board did not respond to the initialization command.

Explanation: The IRQ setting might be incorrect with the hardware setting, or the EEPROM might be corrupted.

Action: Do the following:

1. Verify that the IRQ settings in the NET.CFG file match the configuration settings in the configuration programs. See "PCI Routing" on page 28 for information on setting the interrupt requests.
 2. Verify that the EEPROM on the system board is programmed correctly.
-

PCNTNW-NW-66 The cable might be disconnected from the board.

Explanation: The cable might be disconnected from the server's Ethernet port.

Action: Verify that a cable is connected to the AUI port or the 10BASE-T port.

PCNTNW-NW-071 The matching virtual adapter could not be found.

Explanation: You tried to load another instance of the driver with a different I/O address. This new board could not be found.

Action: If an IBM Ethernet adapter was installed, make sure the adapter is seated properly. Also, check the I/O settings of the board with the settings supplied to the drive.

PCNTNW-NW-072 A resource tag is unavailable.

Explanation: The driver tried to allocate some resources that were not available.

Action: Add or free some memory in the server. Then, restart the server.

PCNTNW-NW-073 Unable to allocate memory.

Explanation: The driver failed to allocate the memory needed for normal operation.

Action: Add more memory, or free some memory resources in the server. Then, restart the server.

PCNTNW-NW-074 The hardware interrupt cannot be set.

Explanation: An attempt was made to initialize a given hardware interrupt. The attempt was not successful.

Action: Do the following:

1. Verify that the Ethernet jumper on the system board is set to the default, enabled position.
 2. Make sure that the interrupt request numbers are set correctly, and that no other devices are using the interrupt. See "PCI Routing" on page 28 for more information.
-

PCNTNW-NW-075 The MLID cannot be registered with the LSL.

Explanation: An error occurred while the driver was trying to register with Link Support Layer.

Action: Check the version of Netware Operating System. Make sure that this driver is correct for the version of Netware installed. Restart the server.

PCNTNW-NW-076 The polling procedure cannot be added.

Explanation: An error occurred while the driver was adding a polling procedure to the Netware Operating System polling routines.

Action: Check the version of Netware Operating System. Make sure that this driver is correct for the version of Netware installed. Restart the server.

PCNTNW-NW-077 The event notification cannot be registered.

Explanation: The driver failed to register its event notification routines with the Netware Operating System.

Action: Check the version of Netware Operating System. Make sure that this driver is correct for the version of Netware installed. Restart the server.

PCNTNW-NW-078 The firmware file cannot be read.

Explanation: The driver to read a firmware file. The read process failed.

Action: Make sure that the support files that were shipped with the driver are present. Restart the server.

PCNTNW-NW-079 The MLID did not initialize MSMTx Free Count.

Explanation: The MSMTx Free Count is not initialized properly.

Action: Restart the server. If the error recurs, replace the system board.

PCNTNW-NW-084 Unable to allocate memory below the 16 megabyte boundary.

Explanation: A request was made to allocate memory below 16 megabytes. The request did not complete successfully.

Action: Free some memory below 16 megabytes, or add more memory below the 16 megabyte boundary.

PCNTNW-NW-086 The driver parameter block is too small.

Explanation: The driver parameter block is too small.

Action: Restart the server. If the error recurs, replace the system board.

PCNTNW-NW-087 The media parameter block is too small.

Explanation: The driver media parameter block is too small.

Action: Restart the server. If the error recurs, replace the system board.

PCNTNW-NW-091 The hardware configuration conflicts.

Explanation: You tried to load a new frame type for the existing adapter. The hardware assumptions made in doing so are incorrect.

Action: Make sure that the hardware configuration matches the software settings. See "PCI Routing" on page 28 for information on viewing and changing interrupt requests.

PCNTNW-NW-092 Cannot schedule AES without an HSM routine.

Explanation: The Netware Operating System needs a Hardware Support Module routine before it schedules an AES event.

Action: Restart the server. If the error is still present, replace the system board.

PCNTNW-NW-093 Cannot schedule interrupt time call back without an HSM routine.

Explanation: The driver needs a Hardware Support Module routine before it can schedule an interrupt time call back.

Action: Restart the server. If the error recurs, replace the system board.

PCNTNW-NW-094 Cannot set hardware interrupt without an HSM routine.

Explanation: The driver needs a hardware interrupt call back routine before it sets the interrupt.

Action: Restart the server. If the error recurs, replace the system board.

PCNTNW-NW-095 Cannot add polling without an HSM routine.

Explanation: The driver needs an HSM polling routine before it can start the polling process.

Action: Restart the server. If the error recurs, replace the system board.

PCNTNW-NW-126 The group bit in the node address override was cleared.

Explanation: The IEEE address has a group bit indicating that an address belongs to a group of stations. This bit is used only as a destination address; it cannot be used as a source address. You tried to enter a source address with this bit set. The driver cleared the group bit of the source address.

Action: None.

PCNTNW-NW-127 The local bit in the node address override was set.

Explanation: The local bit in the IEEE address format indicates that the addresses are being managed locally. If you use the node address override capabilities of this driver to enter a new address, the local bit should be set. You entered an address without the local bit set. The driver has set the local bit.

Action: None.

PCNTNW-NW-164 The device was not found.

Explanation: The driver cannot find an Ethernet controller in the server.

Action: Do the following:

1. Verify that the Ethernet enable jumper is set to the default (enable) position.
2. Go to "General Checkout" on page 2.

PCNTNW-NW-164 Device not found at IOADDRESS.

Explanation: The Ethernet controller cannot be found at the IO address specified in the NET.CFG file.

Action: Verify that the IO Address in the NET.CFG file matches with the board. Otherwise, remove the PORT keyword from the NET.CFG file.

PCNTNW-NW-167 PCI scan specified, device not found.

Explanation: The driver cannot locate the Ethernet controller on the PCI bus.

Action: Perform the following steps:

1. Verify that the Ethernet jumper on the system board is set to the default, enable position.
2. Edit the NET.CFG file to change the BUSTYPE keyword to PCI1.
3. If the problem persists, go to "General Checkout" on page 2.

PCNTNW-NW-180 The DMA parameter is not necessary for PCI device.

Explanation: The Ethernet controller does not require a DMA setting.

Action: Delete the DMA parameter from the NET.CFG file.

Novell NetWare DOS ODI Driver Messages:

the following error messages are for the Novell NetWare DOS ODI device driver. The explanation and recommended action are included with each message.

PCNTW-DOS-1 The LSL is not loaded.

Explanation: The Link Support module (LSL.COM) is not loaded.

Action: Load LSL.COM; then, load the device driver.

PCNTW-DOS-2 The LSL has no more room for a board using Frame <string>.

Explanation: The maximum number of adapters, whether virtual or physical, has been registered with the Link Support Layer. In the PC Server 330 - Type 8640, the DOS ODI LSL can support up to five PCI Ethernet adapters, plus the Ethernet controller in the system board.

Action: Reduce the number of active adapters in the systems by removing an adapter, or by decreasing the number of frame types activated by Multiple Link Interface Driver (MLID).

PCNTW-DOS-3 Could not find PCNTNW MLID to unload.

Explanation: A request was made to unload PCNTNW MLID, but the MLID is not loaded.

Action: None.

PCNTW-DOS-4 A TSR is loaded above the PCNTNW MLID.

Explanation: You tried to unload the PCNTNW MLID from memory, but the PCNTNW MLID detected another Terminate and Stay Resident (TSR) program loaded above the MLID. For the PCNTNW MLID to unload safely, you must first unload any TSR programs that were loaded after you loaded the MLID.

Action: Either unload the other TSR program before loading the PCNTNW MLID, or unload the TSR program before attempting this operation.

PCNTW-DOS-5 PCNTNW MLID could not be unloaded; the operation was aborted.

Explanation: The PCNTNW MLID attempted to remove the resident PCNTNW MLID from memory, and failed. A hardware error has probably occurred.

Action: Run the Ethernet diagnostic.

PCNTW-DOS-6 The adapter did not initialize. PCNTNW did not unload.

Explanation: The hardware did not initialize correctly. The PCNTNW driver did not load.

Action: Check the hardware. Make sure that the board's hardware setting matches its settings in the NET.CFG file.

**PCNTW-DOS-7 You need another PCNTNW MLID
Section Heading in the NET.CFG file in
order to load the MLID again.**

Explanation: You tried to load the PCNTNW MLID a second time. Normally, you would do this so that you could use two or more Ethernet controllers in the server. When two or more of the same type of Ethernet controllers are installed in the server, an associated PCNTNW MLID section heading must be specified in the NET.CFG file.

Action: Create a NET.CFG file and add the commands for both PCNTNW MLID boards to the file. Then, restart the server.

**PCNTNW-DOS-8 A NET.CFG is required to load the
MLID again.**

Explanation: You tried to load the PCNTNW MLID a second time. Normally, you would do this so that you could use two or more Ethernet controllers in the server. When two or more of the same type of Ethernet controllers are installed in the server, an associated PCNTNW MLID section heading must be specified in the NET.CFG file.

Action: Create a NET.CFG file and add the commands for both PCNTNW MLID boards to the file. Then, restart the server.

PCNTNW-DOS-9 The NET.CFG entry has been ignored.

Explanation: The PCNTNW ignored the NET.CFG entry.

Action: Verify that the entries in the NET.CFG file are correct.

The PCNTNW MLID has been successfully removed.

Explanation: A request was made to unload a PCNTNW MLID. The PCNTNW MLID has been removed from memory.

Action: None.

**PCNTNW-DOS-11 The MLID does not support frame
<string:>. The PROTOCOL keyword has
been ignored.**

Explanation: The NET.CFG files specified the PROTOCOL option for a PCNTNW MLID. The specified frame type is not supported by the PCNTNW MLID.

Action: Check the PROTOCOL line in the NET.CFG file for possible omissions of required dashes and underscores or any misspellings.

PCNTNW-DOS-12 The protocol keyword must have a frame type. Entry ignored.

Explanation: The PROTOCOL option was specified in the NET.CFG file for a PCNTNW MLID. The entry failed to specify the associated frame type for the protocol ID addition. An entry in the NET.CFG file for the PROTOCOL option should use the following format:

```
LINK DRIVER PCNTNW
PROTOCOL IPX 8137 ETHERNET_II
```

Action: Specify a frame with the PROTOCOL option.

PCNTNW-DOS-13 The MLID could not register Protocol ID <string> for protocol stack <string> for frame type.

Explanation: The PCNTNW MLID could not register the specified Protocol ID.

Action: Verify the protocol information in the NET.CFG file.

PCNTNW-DOS-14 This version of LSL is not supported.

Explanation: The PCNTNW MLID cannot run successfully using this version of the LSL.

Action: Update your LSL.COM to a newer version.

PCNTNW-DOS-15 The frame type is already activated for frame <string>. The NET.CFG entry has been ignored.

Explanation: Two FRAME keywords under the same main section heading specified the same frame type. A specified frame type can be specified only once per driver.

Action: Remove the duplicate FRAME keyword entry.

PCNTNW-DOS-16 The node address was incorrectly specified in NET.CFG.

Explanation: You used the **NODE ADDRESS** option in the NET.CFG file to override the node address on the network board. The number specified was not a valid Ethernet address. An Ethernet address is six bytes in length. This error occurs if Bit 0 of the first address byte is a 1. This bit must always be 0. For example, if the first byte has the following address, an invalid Ethernet address is generated.

```
    FIRST BYTE
  7 6 5 4 3 2 1 0
  0 0 0 0 0 0 0 1
```

This byte will produce node addresses in the 0100 0000 0000 to 01FF FFFF FFFF range (in hexadecimal), all of which will be invalid.

Action: Specify a valid node address in the NET.CFG file.

PCNTNW-DOS-17 An invalid keyword was specified in NET.CFG on line xx.

Explanation: The keyword specified in the NET.CFG file is incorrect.

Action: Check the keyword in question. Make sure that the keyword is correctly spelled.

PCNTNW-DOS-18 The frame type specified in the NET.CFG file is not supported.

Explanation: The NET.CFG file specified the PROTOCOL option for a PCNTNW MLID. The specified frame type is not supported by the PCNTNW MLID.

Action: Check the PROTOCOL line in the NET.CFG file for possible omissions of required dashes and underscores, or any misspellings. Check the PCNTNW MLID documentation for supported frame types.

PCNTNW-DOS-19 An invalid Ethernet node address is specified in NET.CFG. The MLID modified the incorrect address bits.

Explanation: The NET.CFG file has an invalid node address. The PCNTNW MLID modified and corrected the address.

Action: Verify the node address entries in the NET.CFG file.

PCNTNW-DOS-50 The board cannot be found.

Explanation: The Ethernet controller is either not configured correctly or is disabled.

Action: Perform the following steps:

1. Verify that the Ethernet jumper on the system board is set to the default, enabled position.
 2. Check the settings for the Ethernet controller (for example, the I/O and interrupt request settings) against the settings in the NET.CFG. See "PCI Routing" on page 28 for information on setting the interrupt requests.
 3. If the problem persists, go to "General Checkout" on page 2.
-

PCNTNW-DOS-54 The board did not respond to the initialization command.

Explanation: The Ethernet controller initialization failed.

Action: Verify that the Ethernet jumper on the system board is set to the default, enabled position. Go to "General Checkout" on page 2.

PCNTNW-DOS-58 The board did not respond to the initialization command.

Explanation: The IRQ setting might be incorrect with the hardware setting, or the EEPROM might be corrupted.

Action: Verify that the IRQ settings in the NET.CFG file match the configuration settings in the configuration programs. See "PCI Routing" on page 28 for information on setting the interrupt requests. Verify that the EEPROM on the system board is programmed correctly.

PCNTNW-DOS-61 PCI device IRQ number mismatch.

Explanation: The IRQ number specified in the NET.CFG file does not match with the IRQ number assigned in the configuration programs.

Action: Remove the IRQ number in the NET.CFG file.

PCNTNW-DOS-64 The device was not found.

Explanation: The driver cannot find any PCnet device in the server.

Action: Verify that the Ethernet enable jumper is set to the default (enable) position. Go to "Ethernet Diagnostics" on page 44 to run the diagnostic utility.

PCNTNW-DOS-65 Device not found at IOADDRESS.

Explanation: The device was not found at the IO address specified in the NET.CFG file. The driver cannot find an Ethernet controller in the server.

Action: Verify that the IO address in the NET.CFG file matches with the with the board. Otherwise, remove the PORT keyword from the NET.CFG file.

PCNTNW-DOS-67 PCI scan specified, device not found.

Explanation: The driver cannot locate the Ethernet controller on the PCI bus.

Action: Do the following:

1. Verify that the Ethernet enable jumper is set to the default (enable) position.
 2. Use the BUSTYPE keyword to specify a value of PCI1.
 3. If the problem persists, go to "Ethernet Diagnostics" on page 44 to run the Ethernet diagnostics.
-

PCNTNW-DOS-75 Unsupported bus ID specified.

Explanation: The bus ID number specified in the NET.CFG file is not supported by Novell.

Action: Correct the bus ID number in the NET.CFG file.

PCNTNW-DOS-76 Wrong bus ID specified.

Explanation: The bus ID number specified in the NET.CFG file is different from the bus type found in the server.

Action: Correct the bus ID number in the NET.CFG.

PCNTNW-DOS-80 The DMA parameter is not necessary for PCI device.

Explanation: The board does not require a DMA setting.

Action: Edit the NET.CFG file to delete the DMA parameter.

Novell NetWare OS/2 ODI Driver Messages:

This following error messages are the for the NetWare OS/2 ODI driver. The explanation and recommended action is included with each message.

PCNTNW-OS2-1 The LSL is not loaded.

Explanation: The Link Support Layer module (LSL.SYS) is not loaded.

Action: Load LSL.SYS before loading the driver.

PCNTNW-OS2-21 Could not add the MLID Protocol ID.

Explanation: The PCNTNW MLID could not register the specified Protocol ID.

Action: Edit the NET.CFG file and correct the protocol information.

PCNTNW-OS2-22 Could not allocate memory. The virtual board did not load.

Explanation: The driver could not allocate memory for the virtual adapter.

Action: Check the system configuration.

PCNTNW-OS2-54 The board did not respond to the initialization command.

Explanation: The board initialization failed.

Action: Verify that the Ethernet enable jumper is set to the default (enable) position. Go to "General Checkout" on page 2.

PCNTNW-OS2-56 This interrupt is already used and cannot be shared.

Explanation: The interrupt is already used by another device and cannot be shared.

Action: Assign a different IRQ in the configuration programs. See "PCI Routing" on page 28 for information on setting the interrupt requests.

PCNTNW-OS2-58 The board did not respond to the initialization command.

Explanation: The IRQ setting might be incorrect with the hardware setting, or the EEPROM might be corrupted.

Action: Verify that the IRQ settings in the NET.CFG file match the configuration settings in the configuration programs. See “PCI Routing” on page 28 for information on setting the interrupt requests. Verify that the EEPROM on the system board is programmed correctly.

PCNTNW-OS2-61 PCI device IRQ number mismatch.

Explanation: The IRQ number specified in the NET.CFG file does not match with the IRQ number assigned in the configuration programs. The IRQ numbers might be assigned automatically, or you might have manually assigned the IRQ number.

Action: Remove the IRQ number in the NET.CFG file. Or, see “PCI Routing” on page 28 for information on setting the interrupt requests.

PCNTNW-OS2-64 The device was not found.

Explanation: The driver cannot find the Ethernet controller in the server.

Action: Verify that the Ethernet enable jumper is set to the default (enable) position. Go to “General Checkout” on page 2.

PCNTNW-OS2-65 Device not found at IOADDRESS.

Explanation: The Ethernet controller cannot be found at the IO address specified in the NET.CFG file.

Action: Verify that the IO address in NET.CFG matches with the board. Otherwise, remove the PORT keyword from the NET.CFG file.

PCNTNW-OS2-67 PCI scan specified, device not found.

Explanation: The driver cannot locate the Ethernet controller on the PCI bus.

Action: Do the following:

1. Verify that the Ethernet jumper on the system board is set to the default, enable position.
2. Edit the NET.CFG file to change the BUSTYPE keyword to PCI1.
3. If the problem persists, go to “General Checkout” on page 2.

PCNTNW-OS2-73 Unable to allocate memory.

Explanation: The driver could not allocate memory for the virtual board.

Action: Check the system configuration.

PCNTNW-OS2-80 The DMA parameter is not necessary to PCI device.

Explanation: The Ethernet controller does not require a DMA setting. This parameter is not a valid driver parameter.

Action: Edit the NET.CFG file to delete the DMA parameter.

NDIS 2.01 Driver Messages: The following error messages are for the NDIS 2.01 drivers. The explanation and recommended action are included with each message.

PCNTND-DOS-1 Unable to open the Protocol Manager.

Explanation: The NDIS stack is not configured properly.

Action: Check and correct your configuration.

PCNTND-DOS-6 Out of memory while allocating buffers.

Explanation: The driver could not allocate the requested buffers.

Action: Check your system configuration. Edit the PROTOCOL.INI file to reduce the number of Txbuffers and Rxbuffers specified for the driver.

PCNTND-DOS-7 Protocol Manager device error.

Explanation: The NDIS stack is not configured properly.

Action: Check and correct the configuration.

PCNTND-DOS-8 Bad status for Protocol Manager.

Explanation: The NDIS stack is not configured correctly.

Action: Check and correct your configuration.

PCNTND-DOS-9 Cannot find PROTOCOL.INI entry.

Explanation: The NDIS stack is not configured properly in the PROTOCOL.INI file.

Action: Check and correct your configuration.

PCNTND-DOS-10 The Protocol Manager ioctl failed.

Explanation: The NDIS stack is not configured properly in the PROTOCOL.INI file.

Action: Check and correct the configuration.

PCNTND-DOS-11 Protocol Manager registration failed.

Explanation: The NDIS stack is not configured properly.

Action: Check and correct your configuration.

PCNTND-DOS-15 Device not found.

Explanation: The driver cannot find an Ethernet controller in the server.

Action: Do the following:

1. Verify that the Ethernet enable jumper is set to the default (enable) position.
 2. If the problem persists, go to "General Checkout" on page 2.
 3. Replace the system board.
-

PCNTND-DOS-16 PCI scan specified, device not found.

Explanation: The driver cannot locate the Ethernet controller on the PCI bus.

Action: Do the following:

1. Verify that the Ethernet enable jumper is set to the default (enable) position.
 2. If the problem persists, go to "General Checkout" on page 2.
 3. Replace the system board.
-

PCNTND-DOS-21 Board failed checksum test. Please run configuration utility.

Explanation: The driver cannot find an Ethernet controller.

Action: Do the following:

1. Verify that the Ethernet enable jumper is set to the default (enable) position.
 2. If the problem persists, go to "General Checkout" on page 2.
-

PCNTND-DOS-23 WARNING: PCNET IRQ found =

Explanation: The IRQ setting in PROTOCOL.INI does not match the hardware IRQ setting.

Action: Remove the IRQ setting from PROTOCOL.INI (or match the IRQ setting in PROTOCOL.INI with the configuration settings in the configuration programs. See "PCI Routing" on page 28 for information on setting the interrupt requests.)

PCNTNW-DOS-24 WARNING: PCNET IRQ doesn't match protocol.ini.

Explanation: The IRQ setting in PROTOCOL.INI does not match the hardware IRQ setting.

Action: Remove the IRQ setting from PROTOCOL.INI or match the IRQ setting in PROTOCOL.INI with the hardware jumper setting.

PCNTNW-DOS-25 PCI scan specified, PCI bus not found!

Explanation: The driver cannot locate the Ethernet controller on the PCI bus.

Action: Do the following:

1. Verify that the Ethernet enable jumper is set to the default (enable) position.
 2. Go to "General Checkout" on page 2.
-

PCNTNW-DOS-29 WARNING: DMA number is not necessary for PCI device.

Explanation: The Ethernet controller does not require a DMA setting.

Action: Remove the DMA setting in PROTOCOL.INI.

PCNTNW-DOS-32 IRQ number is already in use by another PCNET device.

Explanation: The specified IRQ number is already in use by another Ethernet controller or device.

Action: Modify the IRQ setting in the PROTOCOL.INI file, or modify the IRQ settings in the configuration programs. See "PCI Routing" on page 28 for information on setting the interrupt requests in the configuration programs.

PCNTNW-DOS-33 PCNET device with specified IOBASE is already in use.

Explanation: The specified IO address number is already in use by another Ethernet controller or device.

Action: Modify the IO address setting on the hardware, or modify the IO address setting in the PROTOCOL.INI file.

NDIS 3.0 Driver Messages: Windows NT error messages are logged into a log file. You can view the file with the Event Viewer. Error messages appear with the "PCNTN3" prefix followed by a "Missing Configuration Parameter" message and several hex numbers. The hex numbers must be converted to decimal values so that they correspond to the error numbers used in this manual.

PCNTN3-9 IO base address is already in use by another PCNET device.

Explanation: The specified IO address number is already in use by another device.

Action: Modify the IO address setting on the hardware or modify the IO Address setting in the setup dialog box.

PCNTN3-13 IRQ and/or DMA number is already in use by another device.

Explanation: The specified IRQ is specified by another device.

Action: Modify the IRQ setting in the setup dialog box.

PCNTN3-18 PCI scan specified, device not found.

Explanation: The driver cannot locate the Ethernet controller on the PCI bus.

Action: Do the following:

1. Verify that the Ethernet enable jumper is set to the default **Enable** position.
2. If the problem persists, go to "General Checkout" on page 2.

PCNTN3-19 LanceOpenAdapter failed.

Explanation: The configuration is set up incorrectly.

Action: Rerun the setup program.

PCNTN3-20 Device at specified IO base address not found.

Explanation: The Ethernet controller cannot be found at the specified IO address.

Action: Verify that the IO address matches with the board. Otherwise, remove the IO Address specification from the setup.

PCNTN3-21 Device not found.

Explanation: The driver cannot find any PCnet device.

Action: Do the following:

1. Verify that the Ethernet enable jumper is set to the default **Enable** position.
2. Go to "General Checkout" on page 2.

Packet Driver Messages: The following error messages are for the packet driver. The explanation and recommended action are included with each message.

PCNTPK-DOS-1 The command syntax is PCNTPK [-n]

[-d] [-w]
<INT=packet_int_no>
[IRQ=int_no] [IOADDR=io_addr]
[DMA=dma_no] [BUSTYPE=bus]
[DMAROTATE] [TP] [LED0=xx]
[BUSTYPE=bus] [LED0=xx]
[LED2=xx] [LED3=xx]

Explanation: The driver command was not entered correctly.

Action: If you entered the command from the command line, enter the command with the correct syntax. If the command is in the AUTOEXEC.NET file, edit the file to correct the syntax. The only parameters that should be included are PCNTPK and BUSTYPE=PC11.

PCNTPK-DOS-2 Unable to reset the PCnet device.

Explanation: The software could not reset the Ethernet controller.

Action: Do the following:

1. Verify that the Ethernet enable jumper is set to the default (enable) position.
2. If the problem persists, go to "General Checkout" on page 2.

PCNTPK-DOS-3 Unable to initialize the PCnet device.

Explanation: The software could not initialize the Ethernet controller.

Action: Do the following:

1. Verify that the Ethernet enable jumper is set to the default (enable) position.
2. Check the interrupt settings in the configuration programs. For more information, go to "PCI Routing" on page 28.
3. If the problem persists, go to "General Checkout" on page 2.

**PCNTPK-DOS-5 There is already a packet driver at
xxxx.**

Explanation: The driver is already loaded at this memory location. It cannot be loaded a second time at the same location.

Action: Do not load the driver again. If you want to load the driver at a different memory location, specify another software interrupt address on the INT parameter.

PCNTPK-DOS-6 <IRQ=int_no> should be between 0 and 15 inclusive.

Explanation: The specified IRQ is out of range for the Ethernet controller.

Action: Use valid IRQ values.

PCNTPK-DOS-7 Packet driver failed to initialize the board.

Explanation: The board initialization failed.

Action: Do the following:

1. Verify that the Ethernet enable jumper is set to the default (enable) position.
 2. Go to "General Checkout" on page 2.
-

PCNTPK-DOS-8 <INT=packet_int_no> should be in the range 0x60 to 0x80.

Explanation: The specified software interrupt number is out of the allowable range.

Action: Specify a valid value for the INT parameter.

PCNTPK-DOS-12 PCI device IRQ number mismatch.

Explanation: The specified IRQ number does not match with the IRQ number assigned by the PCI BIOS.

Action: Remove the IRQ setting.

PCNTPK-15 The device was not found.

Explanation: The driver cannot find an Ethernet controller.

Action: Do the following:

1. Verify that the Ethernet enable jumper is set to the default (enable) position.
 2. If the problem persists, go to "General Checkout" on page 2.
-

PCNTPK-DOS-18 PCI scan specified, device not found.

Explanation: The driver cannot locate the Ethernet controller on the PCI bus.

Action: Do the following:

1. Verify that the Ethernet enable jumper is set to the default (enable) position.
 2. If the problem persists, go to "General Checkout" on page 2.
-

Packet driver is at segment xxxx.

Explanation: The memory address where the packet driver is loaded is xxxx.

Action: None.

Packet interrupt number xxxx.

Explanation: The interrupt number used by the packet driver is xxxx.

Action: None.

My Ethernet address is xxxxxxxxxxxx.

Explanation: The Ethernet address of this station is xxxxxxxxxxxx.

Action: None.

My ARCnet address is xxxx.

Explanation: The ARCnet address of this station is xxxx.

Action: None.

UNIX Messages: The following error messages are for the following UNIX drivers.

- SCO UNIX LLI
- UnixWare DPLI
- SunSoft Solaris

pnt0-2 PCI search specified, PCI device not found!

Explanation: The driver cannot locate the Ethernet controller on the PCI bus.

Action: Do the following:

1. Run netconfig to search for another Ethernet controller.
2. Verify that the Ethernet enable jumper is set to the default (enable) position.
3. If the problem persists, go to "General Checkout" on page 2.

pnt0-6 Cannot allocate memory for the adapter during an interrupt. Please check the Streams parameters.

Explanation: The system is out of Streams memory blocks.

Action: Perform the following steps:

1. Use the CRASH utility to increase the number of Streams memory blocks for the failing size.
2. Modify the IRQ settings in the configuration programs, or run netconfig to match the hardware settings.

pnt0-6 Cannot allocate memory for the adapter during an interrupt! Please check the Streams parameters.

Explanation: On a SunSoft Solaris system, this message indicates that the system is out of Streams memory blocks.

Action: Use the CRASH utility to increase the number of Streams memory blocks for the failing size.

pnt0-7 Cannot allocate memory for the adapter during reset! Please check your Streams parameters.

Explanation: The system is out of Streams memory blocks.

Action: Use the CRASH utility to increase the number of Streams memory blocks for the failing size.

pnt0-11 device not found!

Explanation: The driver cannot find an Ethernet controller.

Action: Do the following:

1. Verify that the Ethernet enable jumper is set to the default (enable) position.
2. Go to "General Checkout" on page 2.

pnt0-12 device failed checksum test!

Explanation: The driver cannot find an Ethernet controller.

Action: Do the following:

1. Verify that the Ethernet enable jumper is set to the default (enable) position.
2. Go to "General Checkout" on page 2.

pnt0-13 add_intr_handler failed! Interrupts already enabled.

Explanation: The IRQ specified or found conflicts with other devices in the system.

Action: Do the following:

1. Modify your hardware settings.
2. Run netconfig to match the hardware settings.

pnt0-14 Cannot locate hardware.

Explanation: The SunSoft Solaris driver cannot find any Ethernet controller.

Action: Perform the following steps:

1. Verify that the Ethernet enable jumper is set to the default (enable) position.
2. Go to "General Checkout" on page 2.

pnt0-15 No more devices to open.

Explanation: The SunSoft Solaris driver cannot find any more Ethernet controllers.

Action: Do the following:

1. Verify that additional IBM PCI Ethernet adapters are present or replace the Ethernet adapter that fails to respond.
2. Go to "General Checkout" on page 2.

pnt0-17 Device fault... Reset initiated!

Explanation: The SunSoft Solaris driver has been reset due to device fault.

Action: Do the following:

1. Verify that additional IBM PCI Ethernet adapters are present or replace the PCnet card that fails to respond.
2. Go to "General Checkout" on page 2.

pnt0-19 IRQ found for PCnet hardware does not match space.c!

Explanation: This is a warning message referring to the IRQ found in the system.

Action: Ignore this message if you are sure that this is what you want to do. Otherwise, run netconfig to match the hardware settings.

pnt0-19 IRQ found for PCnet hardware does not match pnt.conf!

Explanation: This is a warning message referring to the IRQ that the SunSoft Solaris driver found in the system.

Action: Ignore this message if you are sure that this is what you want to do. Otherwise, run netconfig to match the hardware settings.

pnt0-20 add_intr_handler failed! Unknown interrupt type.

Explanation: The IRQ specified or found conflicts with other devices in the system.

Action: Do the following:

1. Modify your hardware settings.
2. Run netconfig to search for another Ethernet controller.

pnt0-21 add_intr_handler failed! Out of range interrupt number.

Explanation: The IRQ specified or found conflicts with other devices in the system.

Action: Do the following:

1. Modify your hardware settings.
2. Run netconfig to search for another Ethernet controller.

pnt0-22 add_intr_handler failed! Out of range IPL.

Explanation: The IRQ specified or found conflicts with other devices in the system.

Action: Do the following:

1. Modify the hardware settings.
 2. Run netconfig to search for another Ethernet controller.
-

pnt0-23 add_intr_handler failed! Vector already occupied.

Explanation: The IRQ specified or found conflicts with other devices in the system.

Action: Do the following:

1. Modify your hardware settings.
 2. Run netconfig to search for another Ethernet controller.
-

pnt0-24 add_intr_handler failed! Vector already shared at different IPL.

Explanation: The IRQ specified or found conflicts with other devices in the system.

Action: Do the following:

1. Modify the hardware settings.
 2. Run netconfig to search for another Ethernet controller.
-

pnt0-26 The DMA number is not necessary for PCI device.

Explanation: The IBM PCI Ethernet adapter does not require a DMA setting.

Action: Edit the SPACE.C file to delete the DMA parameter.

pnt0-29 The IRQ number is already in use by another

Explanation: The IBM PCI Ethernet adapter

Explanation: The specified IO address is already in use.

pnt0-31 IO address is not necessary for the PCI device.

Explanation: The I/O address specified is not required.

Action: Remove the assigned IO address specified for the Ethernet controller.

PC ServeRAID Adapter (FRU No. 06H9334)

The following configuration information and procedures apply only to servers that have a PC ServeRAID adapter installed.

Note

You can use the Administration and Monitoring program or the ServeRAID configuration program for the following tasks. By using the Administration and Monitoring program from the active operating system desktop, you do not have to restart the server. Refer to the README file on the Administration and Monitoring program for instructions for the operating system.

- “Device Drivers” on page 70.
- “Administration and Monitoring Utilities” on page 70.
- “RAID Technology” on page 71.
- “Starting the ServeRAID Configuration Program” on page 75.
- “Viewing the ServeRAID Configuration” on page 77.
- “Performing Common Tasks” on page 78.
- “Resetting the Adapter Configuration” on page 98.
- “Running RAID Subsystem Diagnostic Tests” on page 100.
- “Additional Disk-Array Tasks” on page 101.
- “Restoring the Disk-Array Configuration” on page 102.
- “Changing the Write Policy” on page 102.
- “Formatting Drives” on page 104.
- “Changing the RAID Parameters” on page 105.
- “Changing the ServeRAID Adapter Parameters” on page 107.
- “Using the Mini-Configuration Program” on page 109.
- “ServeRAID Adapter Messages” on page 111.

Device Drivers

The ServeRAID adapter requires the installation of device drivers. See the README file on the Device Driver/Administration and Monitoring diskette for detailed instructions.

If the operating system is installed from the ServerGuide CD, the device drivers will be installed automatically. However, if the operating system is installed from diskettes, the device drivers must be installed. See the README file on the Device Driver/Administration and Monitoring diskette for installation instructions.

Administration and Monitoring Utilities

The Administration and Monitoring program contains RAID monitoring utility programs for several operating systems that the ServeRAID adapter supports. You can monitor the ServeRAID configuration program in the local and remote systems by using these programs.

The following is an example of an Administration and Monitoring program screen.

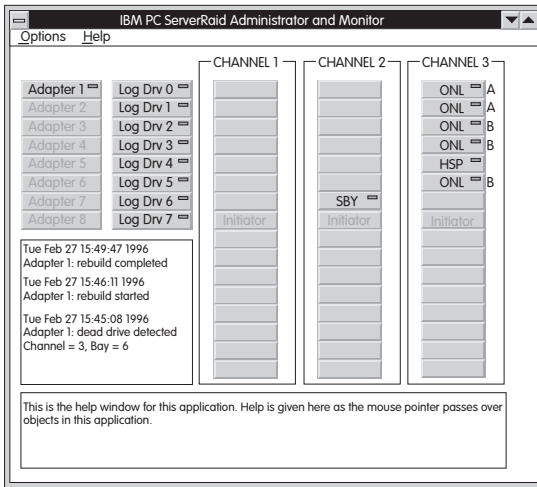

Monitoring the Adapter Status in a Local System:

The Device Driver/Administration Monitoring Program diskette provides monitoring programs that you can use to perform disk-array maintenance tasks. Because the monitoring programs reside on top of the operating system, you do not need to restart the server. Instead, you can perform tasks such as the following from the active operating system desktop:

- Select the adapter that you want to monitor.

- View information about drives connected to the adapter, and change the drive state.
- Reassign a drive to replace a defunct drive.

Some operating systems provide additional features, such as adding and deleting a logical drive. Refer to the README file on the Administration and Monitoring program for specific information and installation instructions.

Monitoring Adapter Status from a Remote System:

The ServeRAID Administration and Monitoring programs support the Client/Server environment using TCP/IP on a variety of platforms. The server programs run on the system containing a ServeRAID adapter and is supported on a number of operating systems. See the README file on the Administration and Monitoring program for more information. The Client program runs in various Windows environments:

- Windows NT Server Version 3.51
- Windows NT Workstation Version 3.51
- Windows 95

The Client program includes many of the functions contained in the ServeRAID configuration program. Because it resides on top of the operating system, you do not need to restart the server to add and remove capacity dynamically when creating or deleting an array. You can start the Administration and Monitoring program from the active operating system desktop.

This monitoring program allows you to:

- View the ServeRAID configuration and associated devices
- Reassign a drive to replace a defunct drive
- Create a logical drive
- Create an array
- Delete an array

In addition, in an array that contains only one logical drive, and the total number of logical drives in all arrays is less than 7, you can change the logical drive RAID level from level 0 to level 5 (or level 5 to level 0).

See the README file on the Administration and Monitoring program for instructions on installing and using this monitoring utility.

RAID Technology

RAID is the technology of grouping several hard disk drives in a server into an *array* that can be defined as a single logical drive. This *logical* drive then appears to the operating system as a single *physical* drive. This grouping

technique greatly enhances logical-drive capacity and performance. In addition, if one of the hard-disk drives fails (becomes defunct) the system continues to run, with no operator intervention required, at reduced performance. You can replace the defunct drive without powering off the server (*hot-swap*). For more information about hot-swappable hard disk drives, refer to the internal drive installation information (Internal Drives, Internal Drive Bays, or Installing internal Drives) in your *IBM PC Server Hardware Maintenance Manual (form number S30H-2501-01)*.

Hard Disk Drive Capacities:

The drives in the disk array can be of different capacities (for example, 1 GB or 2 GB); however, they are treated in the disk array configuration as if they all have the capacity of the smallest disk drive. Therefore, if you have four drives of 1 GB, 1 GB, 1 GB, and 2 GB grouped in one disk array, the total capacity of the array is 1 GB times 4, or 4 GB (instead of the 5 GB physically available).

Notes

1. The total capacity of the array without protection would be 4 GB. With RAID level 5, the usable data capacity would be 3 GB.
2. When referring to hard-disk-drive capacity, GB means 1 000 000 000 bytes; total user-accessible capacity may vary depending on operating environment.

Additional Storage Capacity:

With the Administration and Monitoring program Remote Monitor, you can dynamically add capacity to the server by defining additional arrays and logical drives (when the operating system supports this). When you use the Remote Monitor, you do not have to restart the server to create an array.

When hard disk drives are added to the server, a new disk array must be configured before the drives can be used. Reconfigure the existing disk array to include the capacity offered with the added drives, or group the added drives into their own array (see "Creating a Disk Array" on page 78).

Note

An array can be created with only one drive.

ServeRAID Configuration Program

Screens:

Use the IBM ServeRAID configuration program on the Array Configuration (also called the ServeRAID Configuration) diskette to configure or view the disk array. The following example screen is a compilation of many of the IBM ServeRAID Controller Disk Array Configuration (also called the ServeRAID configuration program) screens. The list that follows example explains the numbered areas of the example.

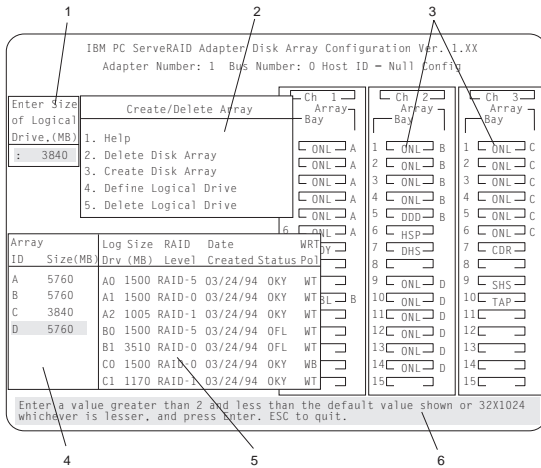

1. This area displays pop-ups that apply to the current menu. For example, a pop-up allows you to select the logical drive size by entering the size in megabytes; or, to accept the default value shown. Another pop-up allows you to select the RAID level you want to assign to the logical drive you are defining. When you need to confirm an action, the Confirm pop-up appears in this area.
2. You can select any of the choices that appear on the menus.
3. The Bay/Array selection list shows 15 bays for each of the adapter's three channels. For each bay that contains a drive, the list indicates the state of the physical drive and the array in which the drive is grouped. For example, in the illustration, the drive in Channel 2, Bay 1, has a drive status of **ONL** and is a part of Array B. Selections are made from this list to determine which bays (hard disk drives) are in the arrays.

Notes

1. The Bay/Array area on the screen does not reflect the physical configuration of the server. In the server, the default numbering for the hard disk drive bays in each bank is 1 through 6 (from left to right).
2. The IDs for the hot-swap drives are set by the backplanes. This allows you to define the IDs as low (0 to 5) or high (8 to 13). Refer to the backplane information in the *PC Server Hardware Maintenance Manual* for the system you are servicing.
3. One channel on the RAID adapter can support two daisy-chained banks of bays. The SCSI ID jumpers on the backplanes must be set to avoid SCSI ID conflicts.
4. The Bay Number corresponds to the SCSI ID of the device plus 1. When the SCSI IDs are set to high, the hard disk drive with SCSI ID 8 is installed in the leftmost bay; its status displays in Bay Number 9.

4. The Array list indicates the array ID and the size (in megabytes) of the array. When a drive is being rebuilt, this area, along with the Logical Drive list area, shows the progression of the rebuilding process.
5. The Logical Drive list identifies the logical drive (for example, A1), including its size, the RAID level, date of creation, and its write policy.

The status of the logical drive also is shown.

OKY No problem conditions are associated with the drive.

CRT Replace the defunct drive and do a rebuild operation. (You will have received a message telling you what has happened to the drive.)

OFL The logical drive is unrecoverable; the data in that drive is lost.

When a drive is being rebuilt, this area, along with the Array list area, shows the progression of the rebuilding process.

During an initialization process, the Write Policy area displays the percent initialized; during a synchronization process, it displays the percent synchronized.

6. The information area tells you the action you can perform on this screen or pop-up.

Starting the ServeRAID Configuration Program

To start the ServeRAID configuration program from the configuration program, insert the diskette into the primary diskette drive and power-on the system. If the system is already powered on, press **Ctrl+Alt+Del**.

During the power-on self test (POST), the RAID adapter checks the configuration information on the adapter and on the hard disk drives connected to it.

- If POST does not detect problems or changes, the Main Menu appears. See “The ServeRAID Adapter Main Menu.”
- If POST detects any change in the adapter configuration, a configuration error message is displayed. See “ServeRAID Adapter POST and Setup Messages” on page 111.
- If POST detects an adapter hardware problem, an error message is displayed. See “ServeRAID Adapter Status and Error Messages” on page 114.

The ServeRAID Adapter Main Menu:

If more than one RAID adapter is installed in the server, you will get an adapter selection screen similar to the following before the Main Menu appears.

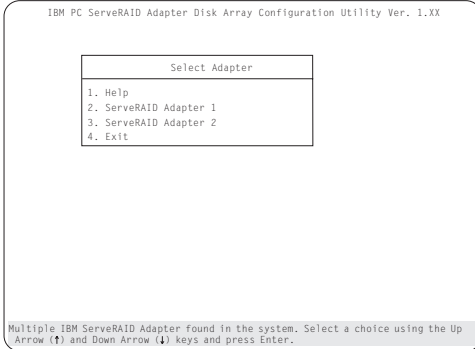

Note

1. The version numbers on the screens might be different. Some menus might differ slightly, depending on the version that was shipped with the server.
2. The primary diskette drive is the first diskette drive that the system tries to start from.

Menu Navigation Keys

Note

You can select **Help** from any menu.

↑ key / ↓ key To select a menu item, use these keys to highlight the item or press the number of the item then **Enter**.

Esc key Returns you to the previous screen or to the previous work area of a screen.

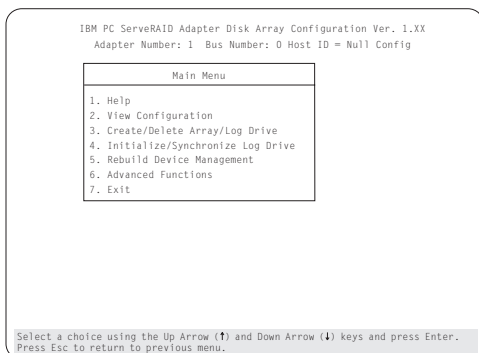

The Main Menu contains the following choices:

- **Help:** Provides additional information.
- **View Configuration:** Displays the existing disk array configuration.
- **Create/Delete Array/Log Drive:** Allows you to select the drives to create an array, or to delete an existing array. It also allows you to define and delete a logical drive.

Whenever you make changes to the disk-array configuration and select **Exit**, the Confirm pop-up window will appear. You must select **Yes** to save and activate the changes.

- **Initialize/Synchronize Log Drive:** Select this choice after creating an array:
 - **Initialize Logical Drive:** You *must* select this choice to set the logical drive to a predetermined value. Any data existing on the drive is overwritten with zeros.

You can choose to initialize more than one logical drive at a time. You can interrupt the initialization process at any time by pressing **Esc**. Then, you can either restart the initialization process by pressing **Enter**, or you can end the process by pressing **Esc** again.

- **Synchronize Logical Drive:** You *must* select this choice to recompute and rewrite the parity data on the selected drive for RAID level 5

before storing data. This selection does not alter data on the drive.

- **Rebuild/Device Management:** Select to rebuild logical drives. The rebuild operation is supported only for RAID levels 1 and 5. You also use this option to define or change the state of a drive, display drive information, and clear the device error table.
- **Advanced Functions:** Select this choice to change the write policy (the way data is written to the drive), to save the configuration information to a diskette, to restore it from a diskette, or to change ServeRAID parameters. This choice also allows you to perform a low-level format on a hard disk and run the RAID subsystems diagnostics. You can initialize the adapter configuration, which resets the configuration values to the factory defaults. You can also synchronize the primary and backup copies of the adapter configuration information.
- **Exit:** Select this choice to leave the Main Menu.

Viewing the ServeRAID Configuration

Before creating or changing a disk array, you can look at the current configuration with the Administration and Monitoring program or the ServeRAID configuration program.

To view the disk-array configuration from the ServeRAID configuration program:

1. Start the server using the ServeRAID configuration program (see "Starting the ServeRAID Configuration Program" on page 75).
2. Select **View Configuration**. The current disk-array configuration information appears on the screen.
3. Press **Enter** to see the stripe order in the Bay/Array list. In the following example, data for the A array is striped across Channel 1, from bay 1, then bay 2, and so on, through bay 6.

IBM PC ServeRAID Adapter Disk Array Configuration Ver. 1.XX
 Adapter Number: 1 Bus Number: 0 Host ID = Null Config

View Configuration				Ch 1 Array Bay	Ch 2 Array Bay	Ch 3 Array Bay
				1 ONL A	1 ONL B	1 ONL C
				2 ONL A	2 ONL B	2 ONL C
				3 ONL A	3 ONL B	3 ONL C
				4 ONL A	4 ONL B	4 ONL C
				5 ONL A	5 ODD B	5 ONL C
				6 ONL A	6 HSP B	6 ONL C
				7 RDP A	7 DHS	7 CDR
				8	8	8
				9 EBL B	9	9 SHS
				10	10	10 TAP
				11	11	11
				12	12	12
				13	13	13
				14	14	14
				15	15	15

Array ID	Size	Log Drv	RAID Level	Size (MB)	Created	Status
A	4300	AD	500 RAID-0	12/12/95	OKY	WT
B	4300	BD	500 RAID-0	12/12/95	OFFL	WT
C	4300	CD	500 RAID-0	12/12/95	OKY	WT

Press Esc to return to main menu. Select array using cursor keys and press Enter to view the stripe order.

4. Press any key to return to the View Configuration screen.

- Press **Esc** to return to the Main Menu.

Performing Common Tasks

The Create/Delete Array menu of the ServeRAID configuration program contains the more common tasks for configuring disk arrays. Use the following procedures to complete these tasks.

- “Creating a Disk Array”
- “Defining Logical Drives” on page 79
- “Defining a Hot-Spare Drive” on page 83
- “Deleting a Disk Array” on page 84
- “Deleting a Logical Drive” on page 85
- “Redefining Space in an Array” on page 86
- “Defining the State of a Drive” on page 91

Creating a Disk Array:

To create a disk array using the ServeRAID configuration program:

- Start the server using the ServeRAID configuration program (see “Starting the ServeRAID Configuration Program” on page 75).

Note

To create an array using hard disks in an existing array, see “Redefining Space in an Array” on page 86.

- Select **Create/Delete Array/Log Drive** from the Main Menu.
- Select **Create Disk Array** from the Create/Delete Array menu.

The cursor becomes active in the Bay/Array selection list.

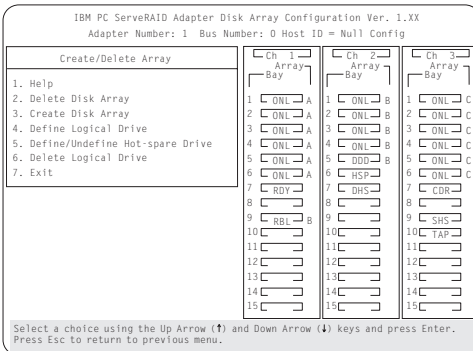

Note

Carefully determine which drives to include in the array before beginning the selection process. If you change your mind after selecting the drives for an array, you can delete the array (by selecting **Delete Disk Array** from the Create/Delete Array menu) and then begin again.

4. Select each drive you want in the array by using the Up Arrow (↑) key or the Down Arrow (↓) key to highlight the drive and then pressing **Enter**. As you select each drive, the status will change from **RDY** (Ready) to **ONL** (Online).
5. When you have selected all the drives you want to include in the array, press **Esc**. The cursor will become active in the menu.

Notes

- When the stripe unit size is 8 K or 16 K, the maximum number of drives in an array is 16.
 - When the stripe unit size is 32 K or 64 K, the maximum number of drives in an array is 8.
6. If you have drives you did not use in this array and you want to create another array, you can do one of the following:
 - Define the logical drive or drives for this array; then create another array and its logical drives. See "Defining Logical Drives."
 - Create another array now by repeating steps 2 through 5 in this procedure; then define logical drives for both arrays.

Note

You must define at least one logical drive for each array created before you can exit from the ServeRAID configuration program.

Defining Logical Drives:

After you have created an array, you must define a logical drive. You can use the Administration and Monitoring program or the ServeRAID configuration program. When you use the Administration and Monitoring program from the active operating system desktop, you do not have to restart the server. Refer to the README file on the Administration and Monitoring program for instructions for the operating system. (You cannot leave the ServeRAID configuration program until you define the logical drives for any arrays created.)

To define a logical drive:

1. Start the ServeRAID configuration program (see “Starting the ServeRAID Configuration Program” on page 75).
2. Select **Define Logical Drive** from the Create/Delete Array menu. The following screen appears; the cursor is active in the Bay/Array list.

IBM PC ServeRAID Adapter Disk Array Configuration Ver. 1.XX
Adapter Number: 1 Bus Number: 0 Host ID = Null Config

Enter Size of Logical Drive.(MB)		1 array		Ch 2 Array Bay		Ch 3 Array Bay	
3	3840	1. Help		1 ONL A B		1 ONL C	
		2. Delete Disk Array		2 ONL A B		2 ONL C	
		3. Create Disk Array		3 ONL A B		3 ONL C	
		4. Define Logical Drive		4 ONL A B		4 ONL C	
		5. Define/Undefine Hot-spare Drive		5 ONL A B		5 ONL C	
		6. Delete Logical Drive		6 DDD A B		6 ONL C	
				7 HSP A B		7 ONL C	
				8 DHS A B		7 CDR C	
				9 ONL A B		8	
				10 ONL A B		9 SHS C	
				11 ONL A B		10 TAP C	
				12 ONL A B		11	
				13 ONL A B		12	
				14 ONL A B		13	
				15		14	
						15	

Array ID	Size(MB)	Log Drv (MB)	Size	RAID Level	Date Created	Status	WRT Pol
A	5760	A0	1500	RAID-5	03/24/94	OKY	WT
B	5760	A1	1500	RAID-0	03/24/94	OKY	WT
C	3840	A2	1005	RAID-1	03/24/94	OKY	WT
		B0	1500	RAID-5	03/24/94	OFL	WT
		B1	3510	RAID-0	03/24/94	OFL	WT
		C0	1500	RAID-0	03/24/94	OKY	WB
		C1	1170	RAID-1	03/24/94	OKY	WT

Enter a value greater than 2 and less than the default value shown or 32X1024 whichever is lesser, and press Enter. ESC to quit.

3. Use the Up Arrow (↑) key or the Down Arrow (↓) key to highlight the array you want to define; then press **Enter**. The Select RAID Level pop-up window appears, and the cursor is active in the window.

Note

The system automatically assigns RAID level 0 to any logical drives defined in an array containing only one hard disk drive. When this is the case, the Select RAID Level pop-up window will not appear.

If only two hard disk drives are in the array, the Select RAID Level pop-up window appears, but RAID level 5 is not selectable because you need at least three hard disk drives in an array to assign RAID level 5 to one of the logical drives. More than one logical drive can be defined in the array. The maximum number of logical drives you can define is eight; the maximum number of physical drives in an array is 8 or 16, depending on the stripe unit size.

Notes

1. If you are planning to change RAID levels using the Administration and Monitoring program, the maximum number of logical drives that can be defined is 7. The RAID conversion procedure requires one free logical drive.
 2. When the stripe unit size is 8 K or 16 K, the maximum number of drives in an array is 16. When the stripe unit size is 32 K or 64 K, the maximum number of drives in an array is 8.
4. Use the Up Arrow (↑) key or the Down Arrow (↓) key to highlight the RAID level you want to assign to these logical drives; then press **Enter**.

Note

Because the level you assign can influence the space needed for the drive, you must assign a RAID level before you enter the size of the logical drive.

The Logical Drive list contains the logical drive ID, the size of each logical drive, the RAID level you assigned to that logical drive, and the date that the logical drive was created.

The status of the logical drive also is shown.

OKY means that all is well with the drive.

CRT means that you must replace the hard disk drive or rebuild the logical drive. (You will have received a message during system startup telling you what has happened to the drive.)

OFL means that the logical drive is unrecoverable; the data on that drive is lost.

If this is the first logical drive to be defined, the Logical Drive Size pop-up window shows the space in the array that is available for logical drives.

If other logical drives have been defined, the Allocation Table appears, showing the logical drive sizes already created, and the amount of free space available.

5. Type the size, in megabytes, that you want for the logical drive; then press **Enter**. A pop-up window appears, asking you to confirm your action.

Information about the new logical drive appears in the Logical Drive list.

Note

The size appearing in the Logical Drive list might be different from the size you typed. The size of a logical drive is determined by a number of factors, but basically the size must be divisible by the number of drives in the array.

Consider the following scenarios:

Scenario 1:

The array consists of three 1 GB drives. You assign RAID level 0 (which uses all the drives in the array with no parity storage), and type 1000MB. The number in the Size (MB) field will be 999, which is the number closest to and lower than 1000 that is divisible by 3.

Scenario 2:

The array consists of three 1 GB drives. You assign RAID level 1, which provides a disk mirroring that stripes data across all drives in the array. Because the data is mirrored, the capacity of the logical drive is 50 per cent of the physical capacity of the hard disk drives grouped in the array. Type 1000MB; the number in the Size (MB) field will be 999. The physical capacity used is 2000 MB, twice that of the logical drive size. The number that is closest to or lower than 2000 and is divisible by 3 is 1998. The logical drive size is 999, which is 50% of the physical capacity.

Scenario 3:

The array consists of three 1 GB drives, and you assign RAID level 5. Data is striped across all three drives in the array, but the space equivalent to that of one drive is used for redundant storage. Therefore, if you type 1000MB, the number in the Size (MB) field remains 1000 because it is divisible by 2 (drives), which is the space available for data.

If you do not use the entire array for this logical drive, you can create another by assigning either the same or a different RAID level for an additional logical drive. You can have as many as eight logical drives among eight disk arrays.

- To return to the Create/Delete Array menu, press **Esc**. To define more logical drives, repeat steps 1 through 5 of this procedure.
- To leave this screen, select **Exit** or press **Esc**. A pop-up window appears asking you to confirm your action.
- To save the changes, select **Yes**. To maintain the disk-array configuration that was in place before you made changes, select **No**.
- To ensure that the server operates correctly, you must select **Initialize Logical Drive**. This sets

the drive to a predetermined state. The initialization process overwrites any data on the drive with zeros.

- a. Select **Initialize/Synchronize Log Drive** from the Main Menu; then select **Initialize Logical Drive**.
- b. Select the logical drives you want to initialize from the Logical Drive list by pressing the Spacebar (the selected drives will appear highlighted). To start the initialization, press **Enter**. A pop-up window appears, asking you to confirm your action.

Attention

If you select **Yes** in the Confirm pop-up window, information in the logical drive will be overwritten with zeros.

- c. Select **Yes** to confirm that you want to initialize this logical drive.

The initialization process begins, and you can see its progress in the **Pct. Int.** (Percent Initialized) column of the Logical Drive list.

- d. To stop the initialization at any time, press **Esc**. Then press **Esc** again to return to the menu, or press **Enter** to continue initializing the drive.
- e. If you defined the drive as RAID level 5, select **Initialize/Synchronize Log Drive** from the Main Menu; then, select **Synchronize Logical Drive** before storing data.

Note

To back up the disk-array configuration to diskette, you will need a 3.5-inch formatted diskette.

To back up the disk-array configuration:

- a. Select **Advanced Functions** from the Main Menu.
- b. Select **Backup config. to diskette**.

Follow the instructions on the screen. A pop-up window shows the default file name of CONFIG. You can change the file name by typing over the default. The Backup program will assign a file-name extension of *.ips*.

Defining a Hot-Spare Drive:

You can define a hot-spare drive from the Create/Delete Array/Log. Drive menu or the Rebuild/Device Management menu (see "Defining the State of a Drive" on page 91).

To define a drive as a hot-spare drive from the **Create/Delete Array/Log. Drive** menu:

1. Start the server using the ServeRAID configuration program (see “Starting the ServeRAID Configuration Program” on page 75).
2. Select **Create/Delete Array/Log. Drive** from the Main Menu. The following screen appears.

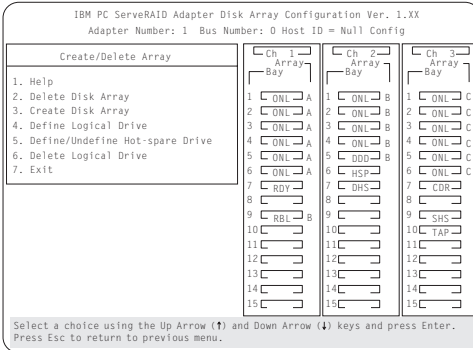

3. Select **Define/Undefined Hot-spare Drive**. The cursor will become active in the Bay/Array selection list.
4. Use the Up Arrow (↑) key or the Down Arrow (↓) key to highlight the **RDY** (Ready) drive you want to define as the hot spare; then press **Enter**. The **RDY** changes to **HSP** (Hot Spare). You can press **Enter** again to toggle between **HSP** and **RDY**.
5. Press **Esc** when you have finished. The cursor will become active in the **Create/Delete Array/Log. Drive**
6. If you want to create a disk array, go to “Creating a Disk Array” on page 78.
7. If you are finished:
 - a. Select **Exit** or press **Esc**. A pop-up window will appear asking you to confirm your change.

Note

The changes you make are not saved until you confirm them by selecting **Yes** in the Confirm pop-up window.

- b. Select **No** if you do not want the drive you selected to be a hot spare; select **Yes** to define it as a hot-spare drive.
- c. Back up the disk-array configuration information to diskette. See “Backing Up The Disk-Array Configuration” on page 101 for instructions.

Deleting a Disk Array

Attention

All the data and programs in the array are lost during this procedure. Before proceeding, back up any data and programs that you want to save.

To delete a disk array:

1. Start the ServeRAID configuration program (see “Starting the ServeRAID Configuration Program” on page 75).
2. Select **Create/Delete Array/Log Drive** from the Main Menu.
3. Select **Delete Disk Array** from the Create/Delete Array menu. The cursor will be active in the Array list.
4. Select the array that you want to delete.
5. Press **Del**. The Confirm pop-up window appears.

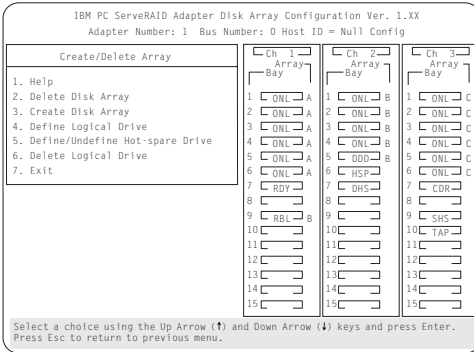

6. If you do not want to delete the array, select **No**. To delete the array, select **Yes**.

Notes

1. To use hard disks from the existing array when creating a new array, you must confirm the deletion of the existing array.
2. In some operating systems, deleting an array and associated logical drives might change the drive letters assigned to the existing drives.

If a defunct drive is still in a bay, the status shows a Defunct Hot-spare (DHS) drive. You can select **Rebuild/Device Management**, then reset the drive state by selecting **Set Device State** (see “Defining the State of a Drive” on page 91 for more information). If the drive is good, set the drive state to Hot-Spare (**HSP**); then, select the drive again and set the drive to **Ready (RDY)**. If the drive is defective, replace it with a good drive; then set the new drive state to **Ready (RDY)**.

Deleting a Logical Drive

1. Start the ServeRAID configuration program (see “Starting the ServeRAID Configuration Program” on page 75).
2. Select **Create/Delete Array/Log Drive** from the Main Menu.

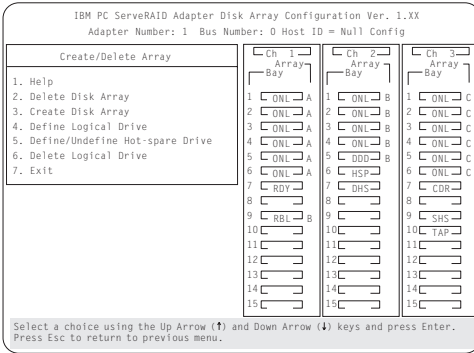

3. Select **Delete Logical Drive** from the Create/Delete Array menu and press **Enter**.
4. Press the Up Arrow (↑) or Down Arrow (↓) key to highlight the logical drive that you want to delete.
5. Press **Del**. The Confirm pop-up window appears.
6. If you do not want to delete the logical drive, select **No**. To delete the logical drive, select **Yes**.
7. Select **Exit** or **Esc** to return to the main menu.

Note

In some operating systems, deleting an array and associated logical drives might change the drive letters assigned to the existing drives.

Redefining Space in an Array:

You can redefine space in a disk array in a number of ways. For example, you can combine a number of small logical drives to create a larger one, or you can redefine the existing logical drive into several smaller drives. Also, you can install additional hard disk drives and create a larger logical drive than was possible with the existing storage capacity.

One method to redefine space in an array is to change the RAID level assigned to a logical drive. For example, if you assigned RAID level 1 to a logical drive and then decided you needed the capacity offered with RAID level 5, you can use this procedure to replace the existing logical drive with a logical drive assigned the new RAID level.

To redefine the space in a disk array, first you must delete the array. In all cases, when you delete an array, all the data and programs in the array are lost.

If you have data and programs that you want to save, they must be backed up and then restored. You might want to use a high-speed backup device, such as a tape drive, for that purpose.

To redefine the space in an array:

Note

You need a 3.5-inch, formatted diskette to backup the configuration file, as described in this procedure.

1. Back up all data and programs in the array.
2. If needed, install additional hard disk drives.

See “Hard Disk Drive Capacities” on page 72 for information about drive sizes.

Attention

In all cases, when you delete an array, all the data and programs in the array are lost.

3. Start the ServeRAID configuration program (see “Starting the ServeRAID Configuration Program” on page 75).
4. Delete the existing array:
 - a. Select **Create/Delete Array/Log Drive** from the Main Menu.
 - b. Select **Delete Disk Array**. The cursor will be active in the Bay/Array selection list.
 - c. Select the array that you want to delete.
 - d. Press **Del**. The Confirm pop-up window appears.
 - e. If you do not want to delete the array, select **No**. To delete the array, select **Yes**.

Note

To use the hard disks from the existing array when creating a new array, you must confirm the deletion of the existing array. After you make your selection, the Confirm pop-up window will disappear, and the cursor will be active in the menu.

- If you want to define a hot spare drive, see “Defining the State of a Drive” on page 91 for step-by-step instructions.
- Create a new disk array and define logical drives.

See “Creating a Disk Array” on page 78 for instructions on creating a disk array and defining logical drives.

5. After you have established the new array and logical drive or drives, select **Initialize/Synchronize Log Drive** from the Main Menu; then select **Initialize Logical Drive** to prepare the drives in the array to receive data. This sets the drive to a predetermined state. Any data existing in the drive is overwritten with zeros.
6. If you defined the drive as RAID level 5, select **Initialize/Synchronize Log Drive** from the Main Menu; then, select **Synchronize Logical Drive** before storing data. Once synchronization starts, it cannot be interrupted until the operation is complete.
7. Insert a 3.5-inch formatted diskette in the primary diskette drive, select **Advanced Functions** from the Main Menu; then select **Backup config. to diskette**. Follow the instructions on the screen.
8. Exit the ServeRAID configuration program by pressing **Esc** or selecting **Exit** from the Main Menu. A pop-up window will appear asking you to confirm your action.
9. Reinstall the operating system and device drivers, then restore the data and programs.

Drive Maintenance:

The following information is about the status indicators for logical and hard disk drives, and the results of a hard disk drive failure. It also contains procedures for defining the state of a hard disk drive and replacing defunct drives.

Obtaining Drive Status: Use the following procedure to see the ID, capacity, type of errors that occurred, and other information about each of the hard disk drives attached to the RAID adapter.

1. Start the ServeRAID configuration program (see "Starting the ServeRAID Configuration Program" on page 75).
2. Select **Rebuild/Device Management** from the Main Menu.
3. Select **Display Drive Information** from the Rebuild/Device Management menu. The cursor becomes active in the Bay/Array selection list.
4. Use the Up Arrow (↑) key or the Down Arrow (↓) key to highlight each of the drives in the Bay/Array selection list. As a drive is highlighted, the drive information appears.

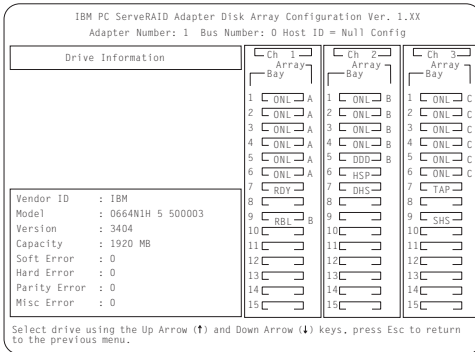

- **Soft Errors** displays the number of SCSI Check Conditions Returned from the Drive status messages (except Unit Attention messages) since the Device Error Table was last cleared.
- **Hard Errors** displays the number of SCSI I/O processor errors or Predictive Failure Analysis (PFA errors) that occurred on the drive since the Device Error Table was last cleared.
- **Parity Errors** displays the number of parity errors that occurred on the SCSI bus since the Device Error Table was last cleared.
- **Misc Errors** displays the number of other errors (such as selection timeout, unexpected bus free, or SCSI phase error) that have occurred on the drive since the Device Error Table was last cleared.

5. Press **Esc** to return to the previous menu.

Notes

- The status of the hard disk drive determines the status of the logical drives in the array in which the hard disk is grouped.
- The device error table, located in the RAID adapter NVRAM, collects statistics on the number and type of errors that occurred on all hard disk drives attached to the RAID adapter.

After correcting a problem with the disk array, you might want to clear the table, so that any subsequent errors can be identified quickly. Select **Erase Device Error Table** from the Rebuild/Device Management menu.

Bay/Array Selection List:

The physical devices connected to each Channel are defined in the Bay/Array selection list as follows:

Status	Meaning
CDR	A CD-ROM drive is installed.

DDD	A drive in the Online (ONL) or Rebuild (RBL) state has become defunct; it does not respond to commands.
DHS	A hot spare or standby hot spare drive enters the Defunct Hot-spare (DHS) state if it fails to respond to the adapter commands.
EMP	No device is present in the bay. This state is represented on the screen with blanks or dashes (— —).
HSP	A hot-spare drive is a hard disk drive that is defined for automatic use when a similar drive fails. The drive capacity of the replacement HSP drive must be equal to or greater than the capacity of the drive being replaced. You must have at least four hard disk drives if you want a hot spare and RAID level 5.
ONL	The drive is online and part of an array.
RBL	The drive is being rebuilt. A physical hard drive can enter the RBL state if: <ul style="list-style-type: none"> • A good working drive replaces a defunct (DDD) drive that is part of the critical logical drive. At the end of a successful rebuild, the state of the physical drive becomes online (ONL), and the state of the corresponding logical drives changes to OKY. • An online drive that is part of a logical drive becomes defunct (DDD) and an HSP or SHS drive with the same or greater capacity is available. The state of the hot-spare drive becomes RBL during the rebuild. When the rebuild completes successfully, the state changes to ONL; the former hot-spare drive is now part of the logical drive. • A Ready (RDY) or Standby (SBY) drive replaces a defunct (DDD) drive that is part of the critical logical drives. The state of the RDY or SBY drive becomes RBL during the rebuild. At the end of a successful rebuild, the state of the drive becomes online (ONL); the drive is now part of the logical drive. <p>For more information on rebuilding a drive, see “Rebuilding a Logical Drive” on page 97.</p>
RDY	The ready drive is recognized by the adapter and is available for definition. A RDY drive becomes EMP when the drive is physically removed from the bay.
SBY	A standby drive is a hard disk drive that has been spun down. Devices such as tape drives and CD-ROM drives are considered to be in a Standby state.

- SHS** A standby hot-spare is a hot spare drive that has been spun down. If a drive becomes defunct and no suitable Hot-Spare drive is available, a Standby Hot-Spare of the appropriate size spins up, and enters the Rebuild process. You must have at least four hard disk drives if you want a standby hot spare and RAID level 5.
- TAP** A tape drive is installed.

Logical Drive States:

The state of the logical drive is determined by the state of the physical drives. Replacing a defunct drive with a good drive changes the state of the logical drive from offline (OFL) to critical (CRT) or good (OKY). When a defunct drive is replaced in a critical logical drive, the data is rebuilt in the replaced drive, before the state of the logical drive changes to OKY.

Status	Meaning
OKY	The drive is in a good functional state.
FRE	The drive is not defined.
OFL	The logical drive is off-line and not accessible. This state occurs if one or more physical drives in a non-redundant logical drive (RAID level 0) is defunct. This state also occurs when two or more physical drives in a redundant logical drive (RAID levels 1 and 5) are defunct.
CRT	A logical drive that is defined as RAID level 1 or 5 contains a defunct physical drive. A critical (CRT) logical drive is accessible despite a physical drive failure.

Note

If the logical drive is critical, you must rebuild the defunct drive.

Defining the State of a Drive:

To define the state of a physical hard disk drive attached to the RAID adapter, you can use the Administration and Monitoring program or the ServeRAID configuration program. By using the Administration and Monitoring program from the active operating system desktop, you do not have to restart the server. Refer to the README file on the Administration and Monitoring program for instructions for the operating system.

To define the state of a drive from the ServeRAID configuration program:

1. Start the ServeRAID configuration program (see "Starting the ServeRAID Configuration Program" on page 75).

2. Select **Rebuild/Device Management** from the Main Menu.
3. Select **Set Device State**. The cursor will become active in the Bay/Array selection list.

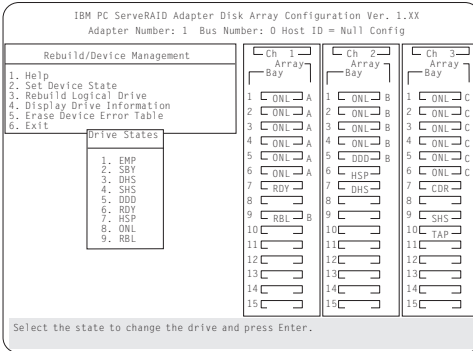

4. Use the Up Arrow (↑) key or the Down Arrow (↓) key to highlight the appropriate drive; then, press **Enter**. The Drive States pop-up window appears, listing all hard disk drive states.
 5. Highlight the appropriate drive state and press **Enter**. The cursor will become active in the Bay/Array selection list, and will display the new state.
- The numbers shown on the left in the Bay/Array selection list area in the previous figure are the bay numbers. See “Bay/Array Selection List” on page 89 for an explanation of the bay numbers.
6. If you want to create a disk array, go to “Creating a Disk Array” on page 78.
 7. If you are finished:
 - a. Select **Exit** or press **Esc**. A pop-up window will appear asking you to confirm your change.

Note

The changes you make are not saved until you confirm them by selecting **Yes** in the Confirm pop-up window.

- b. Select **No** if you do not want the drive you selected to use the new drive state. Select **Yes** to accept the new drive state.
- c. Back up the disk-array configuration information to diskette. See “Backing Up The Disk-Array Configuration” on page 101 for instructions.

Results of a Hard Disk Drive Failure:

Depending on the circumstances, a drive failure can result in several possible situations.

Scenario 1:

- Only one hard disk drive fails.

- A hot-spare drive is defined that is the same size or larger than the failed drive.

The hot spare will take over immediately.

Note

Any logical drives with RAID level 0 are blocked during the Rebuild process, and remain blocked until unblocked. The ServeRAID configuration program automatically unblocks all drives at the end of the rebuild operation.

Scenario 2:

- Only one hard disk drive fails.
- A hot-spare drive is not defined or is smaller than the failed drive.
- The logical drives in the array are assigned RAID levels 0, 1, 5, or a combination of these levels.

All data in logical drives assigned RAID level 0 will be lost. In this array, the logical drives that are assigned RAID level 1 or 5 will be in Critical (CRT) state. The logical drives assigned RAID level 0 will be in the Off-line (OFL) state.

Scenario 3:

If more than one drive in an array fails, all the data is lost in all of the logical drives of the array. For this reason, it is important that you replace and rebuild a defunct drive as soon as possible.

Logical and Hard Disk Drive Status Indications:

The status of the hard disk drive determines the status of the logical drives in the array in which the hard disk is grouped.

- A single hard disk drive failure, (indicated by a **DDD** status in the Bay/Array selection list), generates a **CRT** status for the array's logical drives that are assigned levels 1 and 5. Data in logical drives with a **CRT** is not lost. You must replace the one defunct hard disk drive promptly, and perform a Rebuild operation. If two hard disk drives were to fail, all of the data in the array would be lost.

After you install a new hard disk drive, the Replace process changes the drive status from **DDD** to **RBL** if the array contains a **CRT** logical drive. After the Rebuild process, the hard disk drive status changes from **RBL** to **ONL**.

- A multiple hard disk drive failure causes logical drives in that array that to have an Off-line (OFL) status. This means that data is lost in all the logical drives in

that array, regardless of which RAID level is assigned.

Replacing a Faulty Drive

Attention

The following illustrations of the drives and bays are shown in the vertical position. However, the design of the server may require that the drives be mounted horizontal. Refer to the Location information for the system you are servicing.

Note

The LEDs on the hard disk drive tray provide information about the status of the drive.

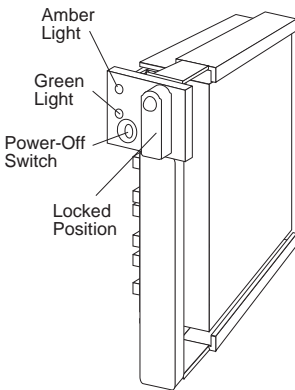

The following is a summary of the LED states and their meanings.

Green	Amber	Description
On	Off	Drive tray is powered on; the hard disk drive is inactive; and the drive should <i>not</i> be removed.
Blinking	Off	The hard disk drive is inactive. The hot-swap drive can be removed safely.
On	On or Blinking	The hard disk drive is in use, and should <i>not</i> be removed.
Off	Off	The drive is defective, or no power is being supplied to the drive. The hot-swap drive can be removed safely.

Check the drive for damage. If the drive is not damaged, check the position of the drive. If it is not inserted correctly, reposition the drive. Verify that the drive is positioned correctly.

Use the following procedure to replace a faulty drive using the ServeRAID configuration program:

1. Start the ServeRAID configuration program (see “Starting the ServeRAID Configuration Program” on page 75).

If the drive failed while the system was powered down, a message identifying the defunct drive appears the next time the system is powered on.

2. Physically replace the drive or assign a hot-spare or other appropriate drive as a replacement:

Attention

Removing the wrong hard disk drive can cause loss of all data in the array.

3. If you are assigning a hot-spare or another appropriate drive to replace the defunct drive, go to “Rebuilding a Logical Drive” on page 97. If you are physically replacing the hard disk drive, go to step 4.
4. Press the power-off switch on the drive tray. When the green LED begins to blink, it is safe to remove the drive.
5. Unlock the drive by turning the knob clockwise 90 degrees.

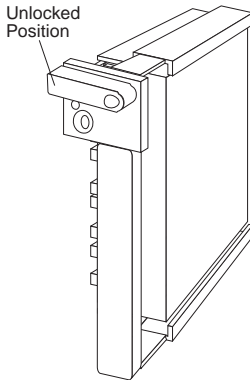

6. Disconnect the drive from the connector on the backplane, by grasping the handle on the drive tray and pulling the drive out of the server. Store the drive in a safe place.
7. Install the hard disk drive:
 - a. Move the tray knob to the unlocked position.

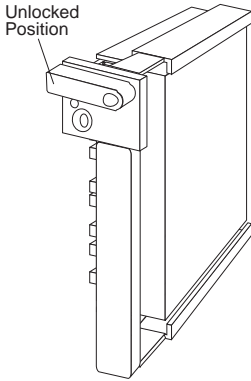

- b. Position the drive tray assembly correctly (vertically/horizontally), with the connector facing the rear of the server.
- c. Align the side of the tray with the raised guides on the bottom of the bay. (Note the arrows pointing towards the backs of the bays.)

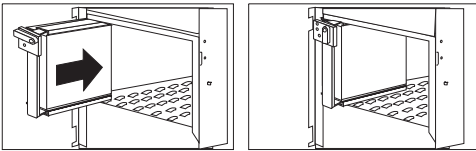

- d. Slide the drive tray to the rear of the bay until it connects to the backplane. Be sure it is connected properly to the backplane.
- e. Move the tray knob to the locked position.

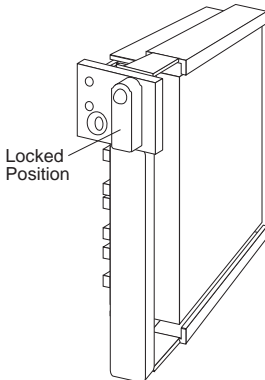

Note

The green light on the front of the drive tray illuminates, indicating that the drive was installed correctly.

- 8. Go to “Rebuilding a Logical Drive” on page 97.

Rebuilding a Logical Drive:

Review the following information before you rebuild a logical drive.

- If the logical drive is critical, you must rebuild the defunct drive.
- Data in a logical drive assigned RAID level 0 is lost during a rebuild. If the drive was backed up before it failed, you can restore the data to this drive.
- If a physical drive being rebuilt contains logical drives defined as RAID level 1 or 5 and a logical drive at RAID level 0, the RAID level 0 drive is blocked to external access during the rebuild.
 - If you initiated the rebuild through the Administration and Monitoring program, you must unblock the RAID level 0 drive when the rebuild is complete.
 - If you initiated the rebuild through the ServeRAID configuration program and the rebuild was interrupted, drives with RAID Level 0 can be automatically unblocked when you restart the server.
- Only one rebuild operation can take place at a time.
- The drive being rebuilt must be the same size or larger than the failed drive.
- If multiple hot-spare drives are available, the adapter searches all bays on each channel for a hot-spare drive of the appropriate size; the first one found enters the Rebuild state.
- Under the following circumstances, a Rebuild operation can be completed quickly:
 - The defunct (DDD) drive was *not* defective.
 - The drive is in the same bay.
 - No write operations or configuration changes that require rebuilding data in the drive have occurred since the hard disk drive entered the DDD state.

If you are using one of the Administration and Monitoring programs provided with the disk-array model, you can use it to identify the defunct drive and designate a drive to replace the defunct drive without restarting the server. Refer to the README file on the Administration and Monitoring program for instructions on the operating system.

To replace a faulty drive using the ServeRAID configuration program:

1. Start the ServeRAID configuration program. When the *Following drives not responding* prompt appears, press **F5** to continue loading the ServeRAID configuration program.
2. Select **Rebuild/Device Management** from the Main Menu.

3. Select **Rebuild Drive** from the Rebuild/Device Management menu. The cursor becomes active in the Bay/Array list.
4. Select the replacement drive that you want to use for the rebuild operation. A pop-up window appears.
 - Select **Same Location** if you physically replaced a hard disk drive in the same bay.
 - Select **New Location** to assign a hard disk drive in a new location. You will be prompted to select the drive that you want.Information and status messages about each stage of the rebuilding process appears on the screen.
5. When the rebuilding process is completed, press **Esc** to return to the Main Menu. The new configuration will be saved automatically.
6. Backup the new configuration (see "Backing Up The Disk-Array Configuration" on page 101).
7. Select **Exit** to end the ServeRAID configuration program.
8. Remove the diskette and press **Ctrl+Alt+Del** to restart the system.

Resetting the Adapter Configuration

The RAID configuration information stored in the adapter NVRAM is critical to reliable operation of the disk-array. Therefore, to protect the integrity of the configuration information, copies of the configuration information are stored in the adapter EEPROM and on each hard disk drive in a Rebuild or On-line state that is defined in the adapter NVRAM configuration. Each time the configuration information is changed, all corresponding copies are updated.

During POST, if the configuration information in the adapter NVRAM, EEPROM, and hard disk drive does not match, an error message appears. You can view each configuration to determine which you want to use.

The Init/View/Synchronize Configuration menu enables you to view or reset the following parameters:

- **Initialize Configuration** restores the factory default settings, and resets all functional, connected, hard disk drives to the Ready (RDY) state.
- **View NVRAM Configuration** displays the current configuration settings for the adapter's NVRAM.
- **View EEPROM Configuration** displays the current configuration settings for the adapter's EEPROM.
- **View Hard Drive Configuration** displays the current configuration settings for the selected hard disk drive that is in the on-line (ONL) or rebuild (RBL) state.
- **View Change List** displays the configuration conflicts that the ServeRAID adapter reported since the last time the server was powered on or restarted. For

more information, see “Viewing Configuration Changes” on page 99.

To initialize, reset, or view the adapter configuration:

1. Start the ServeRAID configuration program (see “Starting the ServeRAID Configuration Program” on page 75).
2. Select **Advanced Functions** from the Main Menu.
3. Select **Init/View/Synchronize Config**.
4. Select your choice from the next menu; then press **Enter**.

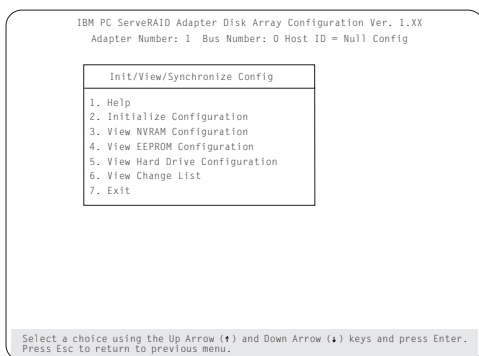

5. Follow the instructions on the screen.

Viewing Configuration Changes:

This option allows you to view the configuration changes that might have occurred since the last time the server was powered on or restarted.

- **View Power-on Change List** displays any drives that have changed states since the last time the server was powered on or restarted.
- **View Wrong SCSI ID List** provides a list of hard disk drives that were found at a different SCSI ID location than the last time the server was powered on or restarted.
- **View Unidentified Drive List** provides a list of hard disk drives that have an identifier that does not match the stored configuration information.

The identifier consists of both the configuration host ID and a time stamp. You can define the host ID as the server serial number or any string, up to 12 characters. (See “Changing the ServeRAID Adapter Parameters” on page 107 for more information.)

Synchronizing the Adapter Configuration:

When the configuration information in the adapter NVRAM, EEPROM, and hard disk drives does not match, you can select one source, and copy the selected configuration

information to the other locations. This menu provides options to synchronize this configuration information.

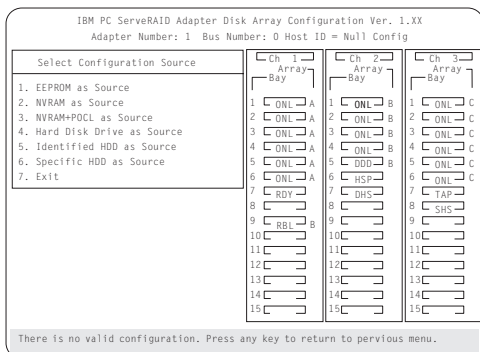

- **EEPROM as Source** copies configuration information from the adapter EEPROM to NVRAM and to all hard disk drives in a Rebuild or On-line state that are defined in the adapter EEPROM configuration.
- **NVRAM as Source** copies the configuration information from NVRAM to the adapter EEPROM and to all hard disk drives in a Rebuild or On-line state defined in the NVRAM configuration.
- **NVRAM and POCL as Source** updates information from the power-on change list with the information in NVRAM. This information is then copied to the adapter EEPROM and to all hard disk drives in a Rebuild or On-line state that are defined in the NVRAM configuration.
- **Hard Disk Drives as Source** retrieves configuration information from hard disk drives. The configuration information is then copied to the adapter NVRAM and EEPROM.
- **Identified HDD as Source** updates the configuration information with stored configuration information on a hard disk drive that matches the identifiers stored in the NVRAM. The updated configuration information is then copied to NVRAM, the adapter EEPROM, and the hard disk drives configured in an array.
- **Specific HDD as Source** retrieves the configuration information with stored configuration information on the hard disk drive that you select. The updated configuration information is then copied to NVRAM, EEPROM, and configured hard disk drives.

Running RAID Subsystem Diagnostic Tests

The ServeRAID Subsystem Diagnostic program provides several utility programs that allow you to test the ServeRAID adapter and the devices connected to it.

To run the RAID diagnostic utility programs, do the following steps:

1. Start the ServeRAID configuration program (see “Starting the ServeRAID Configuration Program” on page 75).
2. Select **Advanced Functions** from the Main Menu.
3. Select **IBM RAID Subsystem Diagnostic**.
4. Select the diagnostic test that you want to run and press **Enter**:
 - **Run Adapter Self-test** runs diagnostic tests on the ServeRAID adapter.
 - **SCSI Device Self-test** runs diagnostic tests on the SCSI devices attached to the ServeRAID adapter.
 - **Drive Media Test** verifies that all sectors on a hard disk drive can be accessed. The drive must be in the RDY or HSP state.
 - **Format Drive** performs a low-level format on a hard disk drive. For more information, see “Formatting Drives” on page 104.
5. Follow the instructions on the screen.

Additional Disk-Array Tasks

The following procedures are for performing additional, less common, disk-array tasks. You can select several utility programs:

- Back up configuration to diskette
- Restore configuration to diskette
- Change the write policy
- Change the RAID parameters
- Format a drive
- Obtain drive status
- Change the RAID adapter parameters

Attention

Notices appear throughout the following procedures to alert you about potential loss of data. Similar messages appear on the screens for these procedures. Read these messages carefully before answering yes to the confirmation requests.

Backing Up The Disk-Array Configuration:

The RAID adapter maintains a record of the disk-array configuration information in its nonvolatile RAM (NVRAM) and electrically erasable programmable read-only memory (EEPROM) module. The disk-array configuration is *vital information*. To protect this information, back up the information to diskette as soon as you have completed your tasks.

To back up the disk-array configuration information to diskette:

Note

You need a blank, formatted, 3.5-inch diskette.

1. Label a blank diskette "Disk Array Configuration Backup," and date it.
2. Start the ServeRAID configuration program (see "Starting the ServeRAID Configuration Program" on page 75).
3. Select **Advanced Functions** from the Main Menu.
4. Select **Backup config. to diskette**.
5. Remove the configuration program from the drive and insert the blank diskette.
6. Follow the instructions on the screen.

Restoring the Disk-Array Configuration

To restore the disk-array configuration information in the ServeRAID adapter, use the configuration program and an up-to-date Disk Array Configuration Backup diskette.

Note

Because dynamic changes in the configuration of the disk array occur due to hot-spare drive replacement or other drive maintenance activity, the configuration backup information on the diskette might be different from that in the adapter. It is important that you back up the disk-array configuration information frequently, to keep the backup information on the diskette current.

To restore the ServeRAID configuration information:

1. Start the ServeRAID configuration program (see "Starting the ServeRAID Configuration Program" on page 75).
2. Select **Advanced Functions** from the Main Menu.
3. Select **Restore config. from diskette**.
4. Follow the instructions on the screen.

Changing the Write Policy

When you configure a logical drive, the RAID adapter automatically sets the write policy to *write-through* (WT) mode, where the completion status is sent *after* the data is written to the hard disk drive. Under certain workloads, you can improve performance by changing this write policy to *write-back* (WB) mode, where the completion status is sent *after* the data is copied to adapter cache memory, but *before* the data is actually written to the hard disk drive.

Although you gain performance with write-back mode, it creates a greater risk of losing data due to a power failure. This is because the system gets a completion status message when the data reaches adapter cache memory, but *before* data is actually written to the hard disk drive.

If you change the write policy to write-back, wait at least 10 seconds after your last operation before you power-off the server. It takes that long for the system to move the data from the adapter cache memory to the hard disk drive. Failure to follow this practice can result in lost data.

To change the write policy:

1. Start the ServeRAID configuration program (see “Starting the ServeRAID Configuration Program” on page 75).
2. Select **Advanced Functions** from the Main Menu.
3. Select **Change Write Policy** from the Advanced Functions menu. The cursor will be active in the Logical Drive list.
4. Select the logical drive whose write policy you want to change. A screen similar to the following appears:

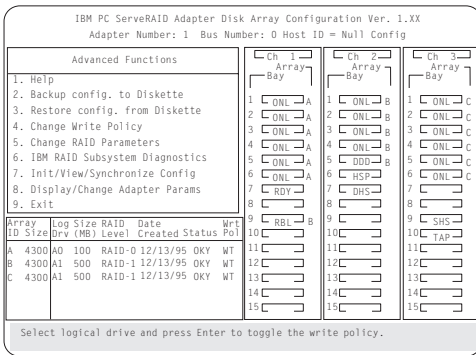

Note

The information might be different from that shown in this screen.

The Logical Drive list contains the logical drive ID, the size in megabytes of each logical drive, the RAID level you assigned to that logical drive, and the date you created it.

The status of the logical drive is also shown. **OKY** means that no problem conditions are associated with the drive; **CRT** means that you must replace the hard disk drive and rebuild the logical drive. (You will have received a message telling you what has happened to the drive.) **OFL** means that the logical drive is unrecoverable; the data in that drive is lost.

5. Locate the **Wrt pol** (Write Policy) field in the Logical Drive list.

The write policy is shown as either **WT** (write-through, which is the default setting) or **WB** (write-back).

6. Select the logical drive whose write policy you want to change.

Attention:

If you change the write policy to write-back, wait at least 10 seconds after your last operation before you power-off the server. It takes that long for the system to move the data from the cache memory to the storage device. Failure to follow this practice can result in lost data.

7. Press **Enter** to change the write policy.
Notice that **WT** changes to **WB**. You can press **Enter** to alternate between **WT** and **WB**.
8. When you have made your choice, press **Esc** to return to the Advanced Functions menu.
9. Select **Exit**. The Confirm pop-up window appears asking you to confirm your action.
10. To return the setting to its original state, select **No**. To save your changes, select **Yes**.
11. Back up the disk-array configuration information to diskette. See "Backing Up The Disk-Array Configuration" on page 101 for more information.

Formatting Drives

You can perform a low-level format on drives with **RDY** (Ready) **EMP** (Empty), **SBY** (Standby), **SHS** (Standby Hot-Spare), or **HSP** (Hot-spare) state.

Note

The **Format Drive** choice on the IBM RAID Subsystems Diagnostics menu provides a low-level format. If you install a new hard disk drive that requires a standard format, use the Format command provided by the operating system.

The ServeRAID configuration program provides the Format program so that you can perform a low-level format on a drive controlled by the RAID adapter.

To perform a low-level format:

1. Start the ServeRAID configuration program (see "Starting the ServeRAID Configuration Program" on page 75).
2. Select **Advanced Functions** from the Main Menu.
3. Select **IBM RAID Subsystems Diagnostics** from the Advanced Functions menu.

Attention

A low-level format erases all data and programs from the hard disk drive. Before proceeding, back up any data and programs that you want to save.

4. Select **Format Drive**. The low-level format program starts.

- Follow the instructions on the screen.

You can perform a low-level format on one drive at a time.

Note

If formatting is interrupted, the drive being formatted might display as an Empty state (- -) or blank in the Bay/Array selection list. Select the drive, and format it again.

Changing the RAID Parameters

To change the RAID parameters:

- Start the ServeRAID configuration program (see “Starting the ServeRAID Configuration Program” on page 75).
- Select **Advanced Functions** from the Main Menu.
- Select **Change RAID Parameters**.

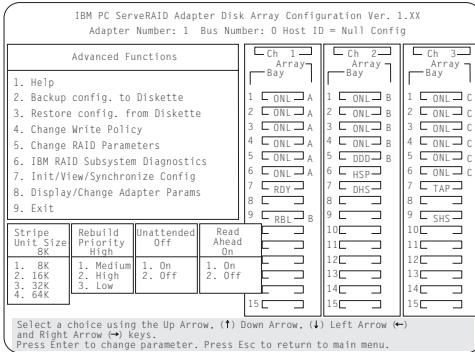

The default settings are:

- Stripe unit size — 8K

Attention:

Once the stripe unit is chosen and data is stored in the logical drives, the stripe unit cannot be changed without destroying data in the logical drives.

The stripe unit size is the amount of data written on a given disk before writing on the next disk. To maximize the overall performance, choose the stripe unit such that the stripe-unit size is close to the size of the system I/O request. The default is set to 8 K data bytes.

Note

When the stripe unit size is 8 K or 16 K, the maximum number of drives in an array is 16.
When the stripe unit size is 32 K or 64 K, the maximum number of drives in an array is 8.

- **Rebuild Priority — High**

Rebuild priority can be set to high, medium, or low. When the rebuild request is set to high, the rebuild I/O request gets high priority in the execution order.

When the rebuild request is set to medium in a heavily loaded system (with a medium rate of system I/O requests), the medium-priority rebuild can reduce the disk rebuild time at the expense of degraded handling of I/O requests.

When the rebuild priority is set to low, in a moderate to heavily loaded system, low rebuild priority will increase the disk rebuild time but provides better system performance.

Note

Rebuild priority can be changed without affecting data in the logical drives.

- **Unattended Mode — Off**

You can enable the adapter to accept changes in the configuration without user input. Unattended mode is useful when the server operates remotely. See “Unattended Mode of Operation” on page 107 for more information.

When Unattended Mode is On, and a hard disk drive is found in a location other than the one defined in the adapter configuration, the program pauses briefly for user input, then, automatically rearranges the configuration information to correct the logical drive configuration. Unattended mode also clears any blocked drives.

When Unattended Mode is Off, the program waits for user input.

- **Read ahead — On**

Normally, the RAID adapter transfers data from disk to its local cache in steps of stripe-unit size. This provides excellent overall performance when workloads tend to be sequential. However, if the workload is random and system I/O requests are smaller than stripe-unit size, reading ahead to the end of the stripe unit will result in a wasted SCSI bus bandwidth and wasted disk utilization. When read-ahead is set to Off, the size of data transfer from the disk to local cache is equal to the system I/O

request size, and no read-ahead to the end of the stripe unit is performed.

Notes

1. The read-ahead setting can be changed without destroying data in a logical drive.
2. When the configuration is saved on a diskette, the RAID parameters are saved also.

Unattended Mode of Operation:

You can enable the adapter to accept changes in the configuration without user input. When this mode is enabled (see “Changing the RAID Parameters” on page 105 for information), the adapter pauses briefly to permit a user to override the default action; then the adapter rearranges the configuration information. Unattended mode also clears any blocked logical drives. This mode is useful when the server operates remotely.

The adapter “chooses” an action that is equivalent to pressing one of the following function key:

F5: The server continues the startup operation after identifying the drive that is defunct. For example, an HSP drive failed to respond during POST. Startup continues without the HSP drive; its drive state will display as DHS.

F6: When a drive has been removed from the server, for example, for maintenance or security, and was returned, but in a different bay, the adapter adjusts the configuration to the drive’s new location.

F7: An adapter with stored configuration information that does not match that of the configured drives present, imports the configuration information from the drives.

The RAID adapter assigns the following priorities to the function keys:

If this action/key is available	Priority of actions
F7	F7, F6, F5
F6	F6, F5
F5	F5

Changing the ServeRAID Adapter Parameters

Display/Change Adapter Parameters allows you to view and change the adapter’s configuration parameters.

To display or change the adapter parameters:

1. Start the ServeRAID configuration program (see “Starting the ServeRAID Configuration Program” on page 75).
2. Select **Advanced Functions** from the Main Menu.
3. Select **Display/Change Adapter Params** and press **Enter**. The following screen appears.

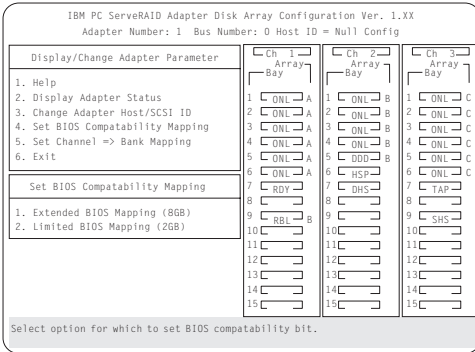

- **Display/Adapter Status** allows you to view the status of the adapter.
- **Change Adapter Host/SCSI ID** allows you to change the adapter SCSI ID and the SCSI transfer rate. You can also define the host configuration ID as any 12 characters. In addition, you can change the number of drives in a group that will startup simultaneously, and set the start-up delay in seconds between groups of drives.
- **Set BIOS Compatibility Mapping** allows you to set the BIOS mapping to 2 GB or 8 GB.
- **Set Channel => Bank Mapping** allows you to specify which bank is connected to each of the internal Channels on the RAID adapter. The following table shows the default mapping.

Bank	Default Connection
C	Channel 3
D	Channel 2
E	Channel 1

You can also specify the setting of the SCSI ID backplane jumper. This mapping is critical for the correct operation of the Administration and Monitoring program, which uses the settings to identify drives, control power to specific drives, and operate the SCSI LEDs.

For example, suppose you daisy-chained banks D and E, connecting the input connector on bank D to Channel 2 on the adapter. The SCSI ID backplane jumper on bank E is set to HI. Refer to the backplane information in the *PC Server*

Hardware Maintenance Manual for the system you are servicing. In this configuration, Channel 1 is available for external devices. Set the Bank Mapping as shown:

Channel	Low ID	High ID
Channel 1	External devices	External devices
Channel 2	D	E
Channel 3	C	

4. Follow the instructions on the screen.

Using the Mini-Configuration Program

The Mini-Configuration program is a quick way to display the adapter settings, and to perform a limited set of the configuration functions without using the RAID Adapter Option Diskette.

To access the RAID adapter Mini-Configuration program:

1. Power-on the server, or, if the system is on, press **Ctrl+Alt+Del**.
2. Press **Ctrl+I** immediately when the Mini-Configuration prompt appears on the screen.
3. Press **Enter**.

If you have more than one RAID adapter installed, you will get an adapter selection screen; otherwise, the Main Menu appears.

- **View Adapter Status** displays the current status of the RAID adapter. (See "Viewing the Adapter Status" for information.)
 - **View Configuration** shows the current configuration information for the RAID adapter. (See "Viewing Configuration Information" on page 110 for information.)
 - **Advanced Functions** resets the adapter, initializes the configuration, and imports the configuration from drives. (See "Using Advanced Configuration Functions" on page 110 for information.)
4. Select a menu item, press the number of the item or use the Up Arrow (↑) key or Down Arrow (↓) key to highlight the item, then press **Enter**.
 5. Follow the instructions on the screen.
 6. Select **Exit** to leave the Main Menu.

Viewing the Adapter Status:

The **View Adapter Status** choice allows you to view the status of the adapter's disk array.

The menu contains the following fields:

- **Unattended** displays the on/off state of Unattended Mode.

- **Boot Block Version** displays the current version number of the Boot Block.
- **Code Block Version** displays the current version number of the firmware on the adapter.
- **Rebuild Rate** displays the speed of rebuild. (See “Changing the RAID Parameters” on page 105.)
- **No. of DDD Drv.** displays the number of defunct drives.
- **No. of OFL Drv.** displays the number of offline logical drives.
- **No. of CRT Drv.** displays the number of critical logical drives.
- **Cfg. Updates** displays the number of times that the configuration has been updated.
- **Flash Prgms** displays the number of times that the firmware flash/EEPROM has been updated.
- **Logical Drive with Bad/Blocked Stripe** identifies any logical drive that has bad stripes, as well as logical drives that are in the blocked state.

Viewing Configuration Information:

The **View Configuration** choice allows you to view the number and size of logical drives installed. It also displays the RAID level, current state, stripe size, write policy, read ahead status, and the creation date for each logical drive.

IBM PC ServeRAID Adapter Disk Array Mini-Configuration Ver. 1.XX

View Adapter Configuration Information
No: 1 Bus: 0 Slot: 14

Logical Drive	Size (MB)	RAID Level	Current State	Stripe Size	Wrt Pol	Read Ahead	Date Created mm/dd/xx
0	100	5	OKY	8K	WT	NO	01/18/96
1	100	5	OKY	8K	WT	NO	01/18/96
2	100	5	OKY	8K	WT	NO	01/18/96
3	100	5	OKY	8K	WB	NO	01/18/96
4	100	5	OKY	8K	WB	NO	01/18/96
5	99	1	OKY	8K	WT	NO	01/18/96
6	200	5	OKY	8K	WT	NO	01/18/96
7	300	1	OKY	8K	WT	NO	01/18/96

Press any key to continue

Using Advanced Configuration Functions:

The **Advanced Functions** choice allows you to reset the RAID adapter, initialize the configuration, and import the configuration from drives.

- **Reset the Adapter** resets the adapter configuration values to the factory defaults.
- **Initialize Configuration** restores the factory default settings and sets all functional, connected hard disk drive states to the Ready (RDY) state.
- **Import Configuration from Drives** reads the configuration information from the drives and copies it

to NVRAM and the EEPROM modules on the adapter.

ServeRAID Adapter Messages

The following information contains the ServeRAID diagnostic and run-time error messages that might appear during startup of a PC Server disk-array model.

The RAID adapter contains a device-error table that collects statistics on the number and type of errors that occur on a selected hard disk drive. After correcting a problem with the disk array, you should clear the table so that you can identify any subsequent errors quickly. For more information, see "Obtaining Drive Status" on page 88.

All hard disk drives contain unique identifiers, such as the drive serial number and manufacturer. During configuration, the RAID adapter stores this information.

The RAID adapter also adds an additional unique identifier, called the host ID, to each hard disk drive that is part of a logical drive. The host ID is a user-defined 12-character string. (See "Changing the ServeRAID Adapter Parameters" on page 107 for information on assigning a host ID.)

ServeRAID Adapter POST and Setup Messages:

During POST, the RAID adapter compares the stored configuration information to the configuration that is actually present. If a discrepancy exists, one or more status messages appear after POST completes, but before the operating system loads. When the RAID adapter requires your input, a list of function keys will appear below the message.

New Drive Installed: When the RAID adapter detects a new drive that is not part of the current configuration, the following message appears:

```
(old state: new state ch: bay)
```

This is an information message. No action is required.

Configured Drives are Missing: When the RAID adapter detects that a previously configured drive is missing, the following message appears:

```
old state: new state: ch: bay
```

where *old state* is the configured state of the drive, *new state* is the state that the RAID adapter will assign to the drive, *ch* and *bay* are the channel and bay where the drive was located previously.

Examples of the possible state changes include:

```
(ONL: DDD x: y)
(RDY: EMP x: y)
(SBY: EMP x: y)
(RBL: DDD x: y)
(HSP: DHS x: y)
(SHS: DHS x: y)
```

Two choices will follow this message:

F4 Retry. Select this key after correcting a problem. For example, select retry after you turn on the external storage enclosure that contains the hard disk drive.

F5 Select this key to accept the new state that the RAID adapter will assign to the drive. For example, the adapter will assign the drive a state of defunct or empty.

You can also select F5 when you must remove a drive, RAID level 1 and RAID level 5 logical drives are present, and performance in a degraded mode is acceptable. The RAID adapter will assign the drive a state of defunct, but the server can complete startup. However, the array will remain in Critical mode and the potential for data loss will exist until you replace and rebuild the defunct drive. To prevent the loss of data, replace and rebuild the defunct drive in a timely manner.

Configured Drives Are Not in the Configured

Location: When the RAID adapter detects that a previously configured drive is present, but the drive is in a new location, the following message appears:

```
(old ch: old bay: > new ch: new bay)
```

where *old channel* is the channel that matches the existing drive configuration information, *old bay* is the bay that matches the existing drive configuration information, *new ch* is the channel where the drive is now located, and *new bay* is the bay where the drive is now located.

For example:

```
(1 :6 > 2:14)
(2 :5 > 2: 6)
```

In this example, the message indicates that the drive from Channel 1, Bay 6 is now located at Channel 2, Bay 14, and the drive from Channel 2, Bay 5 is now located at Channel 2, Bay 6. The drive might have been physically moved to the new bay.

Three choices will follow this message:

- F4** Retry. Select this key after correcting a problem. For example, select retry after you move the hard disk drive to its previously assigned location.
- F5** Select this key to accept the new state that the RAID adapter will assign to the drive. For example, the adapter will assign the drive a state of defunct.
- F6** Select this key to modify the configuration to match the current drive location.

You might remove the hot-swap drives from the server for security reasons. If you replace the drives but install them in different bays, you can press **F6** to accept the new locations, and the RAID adapter will update the configuration.

New Adapter Installed in a Configured Server:

When the RAID adapter detects that the identifiers of the drives do not match the adapter configuration information, the following message appears:

```
host id: old ch: old bay: new ch:new bay
```

where *host ID* is the adapter identification, *old channel* is the channel that matches the drive configuration information, and *old bay* is the bay that matches the drive configuration information. *New ch* is the channel where the drive is now located, and *new bay* is the bay where the drive is now located.

For example:

```
(My Machine : 1:6 > 2:10)
```

In this example, the message indicates that the drive from Channel 1, Bay 6 is now located at Channel 2, Bay 10. The drive might have been physically moved to the new bay.

Two choices will follow this message:

- F4** Retry. Select this key after correcting the problem. For example, select retry after you move the hard disk drive to its previously assigned location, or after you install the original RAID adapter.
- F7** Select this key to import the configuration information from the drive and to update the configuration information on the RAID adapter. This choice is useful when you

replace the RAID adapter in an existing disk-array model.

You also might select F7 if you replace a whole set of drives with drives that were configured in another server with a RAID adapter.

Note

When you install drives in a server that has no logical drives defined, the F7 choice will not appear. This can occur when you replace the RAID adapter itself. The adapter does not contain any logical drives in its factory configuration. Therefore, F7 will not appear. In this case, restart the server and press **Ctrl+I** to enter the Mini-Configuration (see "Using the Mini-Configuration Program" on page 109); then, select **Advanced Functions**. From that menu, select **Import Configuration from Drives to Adapter**.

ServerRAID Adapter Status and Error Messages:

This table lists, in alphabetic order, messages associated with the IBM PC Server SCSI-2 Fast/Wide PCI-Bus RAID Adapter.

Where the "Action" information tells you to start the IBM RAID configuration program, insert the RAID Adapter Option Diskette in the primary diskette drive (usually drive A); then, press **Ctrl+Alt+Del**. The action column also provides general information about the message.

Where *m* or *n* appears in these messages, a number will appear in the actual message.

RAID Adapter Message	Action
<i>n</i> logical drives are installed.	<i>n</i> represents the number of defined logical drives. This is an information message. No action is required.
Controller is not responding to commands. No logical drives are installed.	The RAID adapter is not operational. Make sure that the adapter is fully seated. If the problem persists, have the system serviced.

RAID Adapter Message	Action
<p>Error: Cannot disable this adapter BIOS.</p>	<p>The adapter was unable to prevent an extra copy of the adapter BIOS from being stored on the server. This condition occurs when the server contains multiple RAID adapters.</p> <p>When the prompt to disable extra copies of the adapter BIOS appears, type N (No).</p>
<p>Following drives not responding. (old state: new state ch: bay)</p>	<p>One or more drives did not respond to the adapter. For example, the adapter detected a new drive in an unconfigured bay, and the drive is not part of the current configuration. This might also occur if the adapter detected that a configured drive is missing.</p> <p>Select F5 to accept the new state that the RAID adapter will assign to the drive. For example, the adapter will assign the drive a state of defunct or empty.</p>
<p>Following new drives found. (old state: new state ch: bay)</p>	<p>One or more drives were found in an unconfigured bay. For each drive listed, a new state of Ready (RDY) appears.</p> <p>This is an information message. No action is required.</p>
<p>Following drives found in new location (old ch: old bay > new ch: new bay)</p>	<p>POST found that the location of one or more drives does not match the stored configuration information. (See "Configured Drives Are Not in the Configured Location" on page 112 for more information.)</p>
<p>Installation stopped.</p>	<p>The server cannot access the RAID adapter.</p> <p>This is a follow-on message to a preceding message. Follow the "Action" instructions for the preceding message to resolve the problem.</p>

RAID Adapter Message	Action
<p>Recoverable configuration error; run Configuration program.</p>	<p>The configuration data stored on the adapter NVRAM does not match the configuration data stored in the adapter EEPROM.</p> <p>Insert the IBM RAID Adapter Option Diskette; then, press Ctrl+Alt+Del to restart the system. Select Advanced Functions and synchronize the adapter configuration. See "Resetting the Adapter Configuration" on page 98 for more information.</p>
<p>ServeRAID firmware version xx.yy</p>	<p>This is the version level of the RAID adapter's firmware.</p> <p>This is an information message. No action is required.</p>
<p>WARNING: <i>n</i> logical drives are critical; <i>n</i> logical drives are off-line.</p>	<p>One or more drives have failed.</p> <p>Replace the defunct drives as soon as possible to prevent data loss.</p>
<p>The server has an error due to a Blocked Logical Drive.</p>	<p>One or more logical drives are in a blocked state.</p> <p>Press F4 to unblock the logical drive, or press F5 to continue without any changes.</p>

PC Server Advanced Systems Management Adapter (FRU No. 76H3240)

Note

For a list of FRUs for this product see "Parts Listing (PC Server Advanced Systems Management Adapter)" on page 180.

The IBM PC Server Advanced Systems Management Adapter provides monitoring and event recording functions for ISA and EISA systems when used with TME 10 NetFinity Version 4.1.

Installation Requirements:

The Adapter can be installed only in ISA or EISA systems. The Adapter is supported by TME 10 NetFinity Version 4.1.

Note

If the server has TME 10 NetFinity Version 4.0 installed, download the IBM PC Server Advanced Systems Management Adapter files from:

- IBM PC Server World Wide Web page at <http://www.pc.ibm.com/servers/>
- IBM PC Company Bulletin Board Service (BBS) at (919) 517-0001

Read the README file for instructions.

Device drivers for OS/2, Microsoft Windows NT, and Novell NetWare are provided with the adapter.

Resetting the Adapter and Clearing the Configuration:

If you removed an adapter from one system and are reinstalling it in a different system, you must reset the adapter (clear the configuration) before you reinstall it to avoid possible configuration conflicts. With the adapter removed from the system:

1. Remove the battery from the adapter and set it aside.
2. With a metal paper clip or small metal screwdriver, short the battery-socket contacts on the adapter together. This resets the adapter and clears the configuration.
3. Reinstall the battery on the adapter.

System and Adapter Configuration:

The IBM PC Server Advanced Systems Management Adapter must be configured after installation.

Configuration Considerations:

- The adapter uses only adapter COM B for external communication, therefore a modem or null-modem cable must be connected to adapter COM B.
- To share adapter COM B with the system, adapter COM B must be assigned one of the following I/O addresses:
 - 3F8 (COM 1)
 - 2F8 (COM 2)
 - 3E8 (COM 3)
 - 2E8 (COM 4)
- To dedicate the adapter COM B to the adapter only, adapter COM B must be disabled with the adapter configuration program to prevent the system from accessing it.
- The adapter COM A is not used by the adapter. For the system to use adapter COM A, it must be configured with the adapter configuration program.
- Each port I/O address covers eight contiguous address.
- Make sure there are no conflicts between the adapter port I/O addresses and interrupts you configure, and previously assigned system I/O addresses and interrupts.

The adapter can be configured to the following I/O address ranges and interrupts:

I/O Address Ranges (hex)	Interrupts
100-107	3
120-127	4
140-147	5
168-16F	9
188-18F	10
200-207	11
220-227	14
240-247	15
268-26F	N/A
300-307	N/A

Note: Any listed I/O address range can be assigned with any listed interrupt as long as there are no conflicts with previously assigned system I/O addresses and interrupts.

- If you have an EISA Configuration Utility program (called System Configuration Utility on some systems) go to "EISA Configuration Utility:" on page 119.
- If you do not have an EISA Configuration Utility program, and the system's Configuration/Setup Utility has the ISA Legacy Resources option go to "Configuration/Setup Utility ISA Legacy Resources:" on page 119.

- If you do not have an EISA Configuration Utility program or the Configuration/Setup Utility ISA Legacy Resources option go to “Manual I/O Address and Interrupt Assignment” on page 120.

EISA Configuration Utility:

1. Load the EISA Configuration Utility program.
2. Select Step 2 from the main menu to add the adapter and create the CFG file.
3. Display the available I/O addresses and assign I/O addresses for the adapter ports.
4. Display the available interrupts.
5. Assign interrupts for the adapter ports.
6. Enter the assigned I/O addresses and interrupts on the Configuration Data Worksheet on page 120.
7. Follow the on-screen prompts to exit the utility program.

Go to “Adapter Configuration:” on page 120.

Configuration/Setup Utility ISA Legacy Resources:

1. Restart the system and run the Configuration/Setup Utility.
2. Select the ISA Legacy Resources option.
3. Select I/O Port Resources.
4. Reserve I/O addresses for the adapter ports.
5. Enter the reserved I/O addresses on the Configuration Data Worksheet on page 120.
6. Select Interrupt Resources.
7. Reserve interrupts for the adapter service processor port and the two adapter COM ports.
8. Enter the reserved interrupts on the Configuration Data Worksheet on page 120.
9. Follow the on-screen prompts to exit the Configuration/Setup Utility.

Go to “Adapter Configuration:” on page 120.

Manual I/O Address and Interrupt Assignment:

If you do not have the EISA Configuration Utility program or the Configuration/Setup Utility ISA Legacy Resources option, follow this procedure.

1. Select available I/O addresses and interrupts for the adapter ports.
2. Enter these I/O addresses and interrupts on the Configuration Data Worksheet below.

Configuration Data Worksheet		
	I/O Address	Interrupt
Service Processor Port		
Adapter COM A		
Adapter COM B		

Continue with "Adapter Configuration:."

Adapter Configuration:

1. Power-off the system.
2. Make sure the adapter configuration diskette is not write protected.
3. Insert the adapter configuration diskette into the diskette drive.
4. Press **Ctrl+Alt+Del** to restart the system.

The adapter configuration Flash Utility menu is displayed:

Flash Utility

Select one:

Configure Service Processor
View Service Processor Configuration
Update Service Processor
Set Up COM Ports
Configure OS Watchdog Timer
Exit

Enter F1=Help F3=Exit

5. Look at the two LED displays on the adapter and check the dot on each LED for the indications listed in the table on page 121.

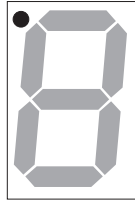
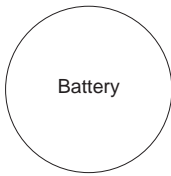

CR2

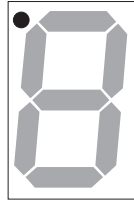

CR1

<p>CR1 Dot On</p> <p>Problem indication. Check: 34-pin interface cable connection Replace: Cable then, Adapter.</p> <p>Note</p> <p>For Advanced Systems Management External Power Control Units, replace the 10-pin External Power Source Cable then, the External Power Control Unit.</p>	<p>CR1 Dot Off</p> <p>Normal. Check CR2 Dot.</p>
<p>CR2 Dot Blinking</p> <p>Normal; microcode is loaded. Go to step 6.</p>	<p>CR2 Dot Off</p> <p>Microcode is not loaded. Select Update Service Processor on the Flash Utility menu and follow the prompts. Then return to step 5 on page 120. If CR2 continues to be off, replace the adapter battery. (See "Battery Notice" on page 187)</p>
<p>Note: If you reset the adapter by following the procedure "Resetting the Adapter and Clearing the Configuration" on page 117, CR2 Dot will be off and you must select Update Service Processor on the Flash Utility menu.</p>	

6. Refer to the configuration data worksheet on page 120 and complete the following steps.
 - a. Choose **Configure Service Processor** from the Flash Utility menu and select the port and IRQ you entered in the configuration data worksheet. The utility program writes an SM.INI file to the diskette. This file is used during the device driver installation.
 - b. Follow the on-screen prompts and choose **Setup COM Ports** from the Flash Utility menu. Select the COM port I/O addresses and interrupts you entered on the configuration worksheet.

7. Follow the on-screen prompts to exit from the adapter configuration utility program.
8. Replace the system cover.

Go to "Device Driver Installation" for device driver installation instructions.

Device Driver Installation:

If the operating system is OS/2, go to "OS/2 Device Driver Installation."

If the operating system is Windows NT, go to "Windows NT Device Driver Installation."

If the operating system is Novell NetWare, go to "Novell NetWare Device Driver Installation" on page 123.

OS/2 Device Driver Installation:

The OS/2 adapter device driver is stored in the C:\OS2 and C:\OS2\DLL directories unless otherwise specified by you. The CONFIG.SYS file is also updated.

To install the adapter device driver and dynamic link library (DLL):

1. Insert the adapter configuration diskette into the diskette drive.
2. Open an OS/2 window.
3. At the OS/2 prompt type:
A:
and press **Enter**.
4. At the A: prompt type:
OS2\SETUP
and press **Enter**.
5. Follow the menu prompts to complete the installation.
6. Restart the system to activate the device driver.

Refer to the TME 10 NetFinity Version 4.1 documentation for information on the operation and functions of the adapter.

Windows NT Device Driver Installation:

The Windows NT adapter device drivers are stored in the Windows NT system directories.

To install the adapter device drivers:

1. Insert the adapter configuration diskette into the diskette drive.
2. Log on with administrator privileges.
3. Open a DOS window.
4. At the DOS prompt type:
A:
and press **Enter**.
5. Type CD\NT
and press **Enter**.
6. Type SETUP

and press **Enter**.

The adapter device drivers are loaded and started.

Refer to the TME 10 NetFinity Version 4.1 documentation for information on the operation and functions of the adapter.

Novell NetWare Device Driver Installation:

To install the Novell Netware adapter device driver:

1. Insert the adapter configuration diskette into the diskette drive.
2. At the NetWare prompt type
LOAD A:\NETWARE\SETUP
and press **Enter**.
3. Follow the on-screen prompts. If you accept the default choices, the adapter device driver is copied to the hard disk as SYS:\SYSTEM\IBMSPN.NLM, and the AUTOEXEC.NCF file is updated.
4. To load the adapter device driver:
 - a. Restart the system.

Or

- b. At the NetWare prompt type
SEARCH ADD *path* (where *path* is the path the driver was copied to in step 3)
and press **Enter**.

At the NetWare prompt type

LOAD IBMSPN *port-adrs irq* (where *port-adrs* is the port address you selected and *irq* is the interrupt you selected during the adapter configuration procedure)
and press **Enter**.

The adapter device driver will load without restarting the server.

Refer to the TME 10 NetFinity Version 4.1 documentation for information on the IBM PC Server Advanced Systems Management Adapter operation and functions.

Adapter Cable to System Board

Connections:

Note

It is easier to connect the cables to the system board and adapter before you install the adapter in the system.

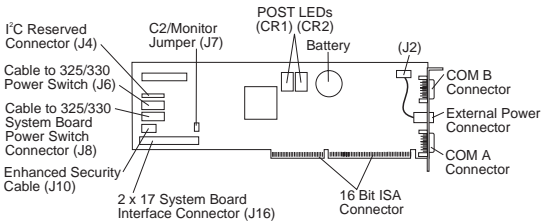

PC Server 325:

Refer to the IBM PC Server 325 Hardware Maintenance Manual for system board layout.

- 34-pin cable from Adapter (J16) to System Management Cable Connector (J19) on system board.
- 16-pin cable from Adapter (J8) to Operator Panel Connector (J7) on system board.
- Cable from Operator Panel to Adapter (J6).

PC Server 330:

Refer to "System Board" on page 162 for system board layout.

- 34-pin cable from Adapter (J16) to System Management Cable Connector (J19) on system board.
- 16-pin cable from Adapter (J8) to Operator Panel Connector (J7) on system board.
- Cable from Operator Panel to Adapter (J6).

PC Server 704:

Refer to the IBM PC Server 704 Hardware Maintenance Manual for system board layout.

Note

The PC Server 704 Adapter installation requires:

- 34-pin-to-26-pin PC Server Systems Management Cable (separately purchased)
 - PC Server Advanced Systems Management External Power Control Unit (separately purchased)
-
- 26-pin end of the systems management cable to the System Management Cable Connector (J3G1) on the system board.
 - 34-pin end of the systems management cable to Adapter connector (J16).
 - Connect the External Power Control Unit control cable, **1**, external power control unit power cord, **2**, and system power cords, **3**, as shown:

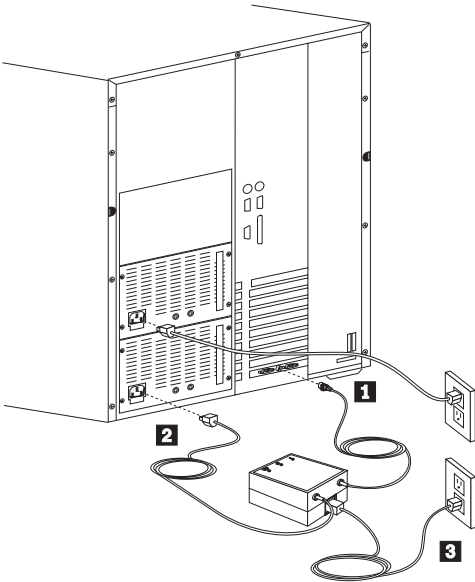

Note

For other ISA or EISA PC Server Advanced Systems Management Power Unit Connections, see the Adapter installation instruction.

External Power Control Unit Operation and Indicators:

The external power control unit provides power to the system under control of the adapter.

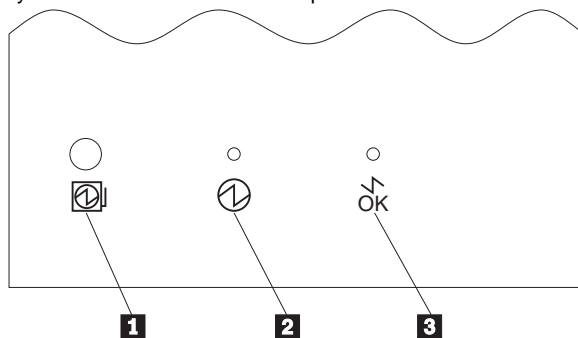

- The Power Status LED **2** On indicates power is enabled to the system. The Power Status LED Off indicates power is disabled to the system.
- The Cable Attached LED **3** On indicates the power unit control cable is connected to the adapter. The Cable Attached LED Off indicates the external power control unit control cable is not connected to the adapter.
- If system power from the external power control unit is disabled by the adapter, press the external power control unit power on button **1** to enable system power from the external power control unit.

Power Status LED 2	Cable Attached LED 3	Indicates	Action/FRU
On	On	System power is enabled and the external power control unit signal cable is connected to adapter.	None
Off	On	The adapter has caused system power to be removed and the external power control unit signal cable is connected to adapter.	<ol style="list-style-type: none"> 1. Press the external power control unit power on button to restore system power. 2. Check system power-on switch. 3. By-pass power module unit by plugging the Server directly into the AC wall socket. 4. Power module 5. A.C. power cord
Off	Off	External power control unit signal cable is not connected to adapter.	<ol style="list-style-type: none"> 1. Connect the cable to the adapter. 2. External power control unit signal cable 3. External power control unit 4. Adapter

Power Supply Voltages

If the voltages are correct and the power supply fan runs, the power supply is OK.

Connector P1

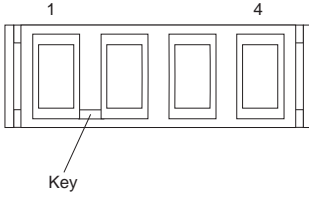

-Lead Pin	+Lead Pin	V dc Minimum	V dc Maximum
3	1	+ 4.8	+ 5.25
4	2	+ 4.8	+ 5.25

Connector P2

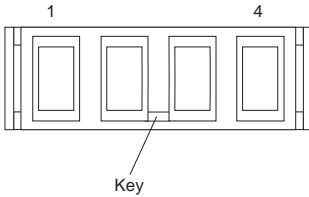

-Lead Pin	+Lead Pin	V dc Minimum	V dc Maximum
3	1	+ 3.3	+ 3.46
4	2	+ 3.3	+ 3.46

Connector P3



-Lead Pin	+Lead Pin	V dc Minimum	V dc Maximum
2	4	+ 11.52	+ 12.6
2	5	+ 11.52	+ 12.6
2	8	- 10.8	- 13.2
2	10	+ 4.8	+ 5.25
2	11	- 4.5	- 5.5

Connector P4, P5, P6, P7, P8

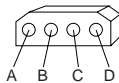

-Lead Pin	+Lead Pin	V dc Minimum	V dc Maximum
C	A	+ 4.8	+ 5.25
B	D	+ 11.52	+ 12.6

SCSI IDs

For all hot-swap servers:

- Fast/Wide (16-bit) devices support SCSI IDs 0 to 15
- Narrow (8-bit) devices support SCSI IDs 0 to 7

<i>Table 1. SCSI IDs for Preinstalled SCSI Devices</i>		
SCSI ID	Bay	Device
Non-Hot-Swap Servers		
6	6	CD-ROM Drive
7	N/A	SCSI-2 Controller
Hot-Swap Servers without RAID		
0–5See Note	1–6	Hot-Swappable Hard Disk Drives
6	7	CD-ROM Drive
7	N/A	SCSI-2 Controller
Hot-Swap Servers with RAID		
0–5See Note	1–6	Hot-Swappable Hard Disk Drives
6	7	CD-ROM Drive
7	N/A	IBM PC Server SCSI-2 Fast/Wide PCI-Bus RAID Adapter
Note: SCSI IDs are preset by the hot-swap bay backplane.		

Note

If the SCSI bus is improperly terminated, poor signal quality can cause intermittent errors reading from or writing to SCSI devices on the bus.

The 8X CD-ROM drive, FRU 73H2601, on Non-hot-swap models, might not provide termination as indicated on the CD-ROM label.

For proper termination, terminate the SCSI bus as follows:

- Install another SCSI device that can provide active termination
- or -
- Install the 8-bit in-line active terminator, FRU 61G2448, for use on narrow SCSI cables or the 16-bit active terminator, FRU 92F0322, for use on wide SCSI cables.

SCSISelect Utility Program

The server is shipped with a menu-driven configuration utility program, called SCSISelect, that allows you to view and change SCSI settings.

You can use the SCSISelect Utility program to:

- View and change the default values
- Verify and change configuration conflicts
- Perform a low-level format on a SCSI hard disk

Starting the SCSISelect Utility Program:

You can access this program when you start the server. The SCSISelect prompt appears after the IBM PC Server screen appears briefly and then disappears. Press **Ctrl+A** immediately after the SCSISelect prompt appears.

Use the Up Arrow (↑) and Down Arrow (↓) key to move the highlight bar to the various menu choices. Press **Esc** to return to the previous menu. Also, you can press the F5 key to switch between color and monochrome modes (if the monitor permits). To change the settings of the displayed items, follow the directions on the screen.

SCSISelect Utility Program Options: The following options appear on the SCSISelect Utility program menu:

- Configure/View Host Adapter Settings
- SCSI Disk Utilities

Configure/View Host Adapter Settings: To view or change the SCSI controller settings, select

Configure/View Host Adapter Settings and follow the directions on the screen. This menu has the following selections:

- Host Adapter SCSI ID
Select this choice to change the SCSI ID of the SCSI controller from its default value of 7.
- SCSI Parity Checking
The default value is *Enabled*. This value should not be changed.
- Host Adapter SCSI Termination
Select this choice to configure SCSI controller termination. The default value is *Low On/High On*.
- SCSI Device Configuration
Select this choice to configure SCSI device parameters. Before you can make updates, you must know the ID of the device whose parameters you want to configure.
- Advanced Configuration Options
Select this choice to view or change the settings for advanced configuration options. These options

include enabling support large hard disk drives and support for drives with Ultra SCSI speed.

SCSI Disk Utilities: To see the IDs that are assigned to each SCSI device or to format a SCSI device, select **SCSI Disk Utilities** from the SCSISelect Utility program menu.

To use the utility program, select a drive from the list. Read the screens carefully before making a selection.

Note

If the following screen displays, you might have pressed **Ctrl+A** before the selected drives spun up. Restart the server and watch the SCSISelect messages as each drive spins up. After the drive that you want to view or format spins up, press **Ctrl+A**.

```
Unexpected SCSI Command Failure

Target SCSI ID:          4
SCSI CDB Sent:          03 00 00 00 0E 00 07 00 02 00
Host Adapter Status:    00h - No host adapter error
Target Status:          02h - Check condition
Sense Key:              02h - Not ready
+Sense Code:             04h
+Sense Code Qualifier:  02h

Press 'Esc' to continue.
```

Performing a Low-Level Disk Format: You can perform a low-level format on a hard disk drive using the *Format Disk* feature of the SCSISelect Utility program.

Depending on the hard disk capacity, the low-level format program could take up to two hours.

When To Use the Low-Level Format Program:

Use the Low-Level Format program:

- When installing software that requires a low-level format
- When recurring messages from the diagnostic tests directing you to run the low-level format program on the hard disk appear.
- As a last resort before replacing a failing hard disk drive

Note

For information about backing up all of the files, see the operating-system documentation.

Starting the Low-Level Format Program**Attention**

The low-level format program erases *all* data and programs.

1. If the hard disk is working, make a backup copy of all the files and programs on the hard disk.
2. Select **Format disk** from the SCSISelect Disk Utilities menu; then follow the instructions on the screen.

Note

Hard disks normally contain more tracks than their stated capacity (to allow for defective tracks). A message appears on the screen if the defect limit is reached. If this happens, have the system serviced.

3. To install an operating system after the hard disk drive is formatted, refer to the README file in Start Here on the ServerGuide Main CD.

Saving Configuration Settings: When you finish configuring the server, you can save the CMOS and NVRAM configuration data to a diskette. This is useful in case you have to clear CMOS or replace the system board, and you want to restore the existing configuration.

Refer to the README file on the PC Server Utilities Diskette for specific procedures on backing up and restoring CMOS and NVRAM configuration data.

Note

Make a separate backup copy of the utilities diskette for each server configuration saved.

Undetermined Problems

You are here because the diagnostic tests did not identify the failure, there is no Devices List, or the system is inoperative.

Note: If you suspect a software mismatch is causing failures (solid or intermittent), be sure to see “Software/Hardware Mismatch Problems” on page 188.

Check the power supply voltages. See “Power Supply Voltages” on page 128. If the voltages are not correct, replace the power supply. If the voltages are correct, return here and do the following:

1. Power-off the computer.
2. Remove or disconnect the following (one at a time) until you find the failure (power-on the computer and reconfigure each time).
 - Any external devices
 - Surge suppressor device (on the computer)
 - Modem, printer, mouse, or non-IBM devices
 - Each adapter
 - Drives
 - Memory-Module Kits

Note

The minimum operating requirements for the PC Server 330 - Type 8640 are:

- System board
- Processor board with:
 - Processor
 - 1 memory DIMM
- Cooling fan

3. Power-on the computer. If the problem remains, suspect the system board, then the processor board in that order.

Note

If the problem goes away when you remove an adapter, and replacing that adapter does not correct the problem, suspect the system board or processor board.

System/Processor Board Replacement

When replacing the system board, make sure jumpers, cables, adapter cards, and processor board are installed and seated correctly on the new system board.

The PC Server 330 Type 8640 computer might have two processors, and other components installed on the processor board. When replacing the processor board, remove all of the installed components from the old

processor board and install them on the new processor board. If the problem remains, check the following:

- The processor is installed and seated correctly in socket (U5) on the processor board.
- If installed, the optional processor is seated correctly in socket (U6) on the processor board.
- All other components removed from the old processor board or system board are installed and seated correctly on the new board.

Note

If the processor(s) are not seated correctly, intermittent problems can occur.

Symmetric Multiprocessors/Multiprocessing

The PC Server 330 Type 8640 has a second upgradable processor socket on the processor board to support Symmetric Multiprocessors/Multiprocessing (SMP). The SMP capability extends processing performance by allowing tasks to be dispatched to the next available processor rather than being queued until the busy processor has completed its task. The SMP capability also provides a level of high availability in that some operating systems run in a uni-processor mode if one of the processors should experience a failure. This function will allow the LAN to continue operation so that service can be scheduled at a non-critical time.

Note

If the optional processor is installed, the optional processor is the boot processor.

Locations

- “Air Baffle” on page 136.
- “Bezels (DASD)” on page 137.
- “Controls and Indicators (Non-Hot-Swap Server)” on page 138.
- “Controls and Indicators (Hot-Swap Server)” on page 139.
- “Card Guide” on page 142.
- “Cover (Top)” on page 143.
- “DASD Cage (3-Drive)” on page 143.
- “Door (Front)” on page 144.
- “Drives (Non-Hot-Swap)” on page 144.
- “Drives (Hot-Swap)” on page 145.
- “Expansion Slots” on page 146.
- “Front Bezel/Door Assembly” on page 147.
- “Input/Output Connectors” on page 148.
- “Internal Drive Bays (Non-Hot-Swap Servers)” on page 150.
- “Internal Drive Bays (Hot-Swap Servers)” on page 152.
- “Memory Module” on page 153.
- “Operator Panel” on page 154.
- “Operator Panel Status Indicators” on page 155.
- “Optional Processor” on page 157.
- “Retention Bracket” on page 158.
- “Processor Board” on page 159.
- “System Board” on page 162.
- “U-Bolt” on page 164.

Air Baffle

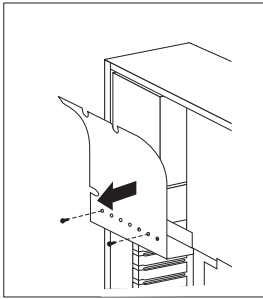
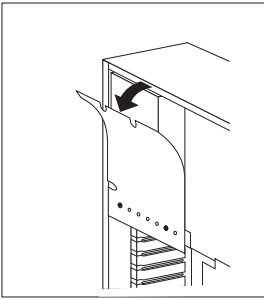
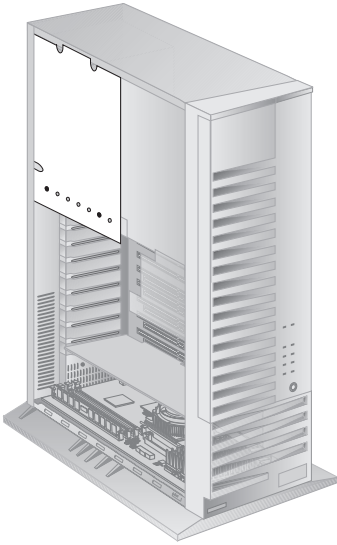

Bezels (DASD)

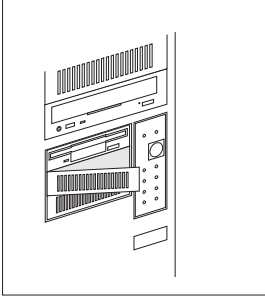
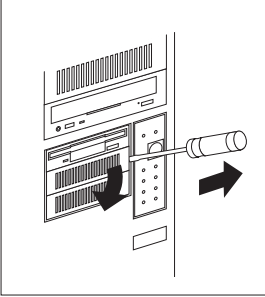
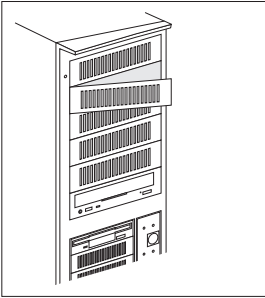
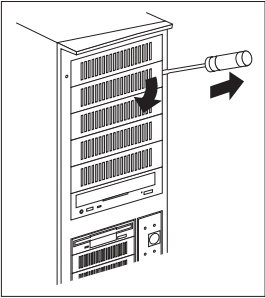

Controls and Indicators (Non-Hot-Swap Server)

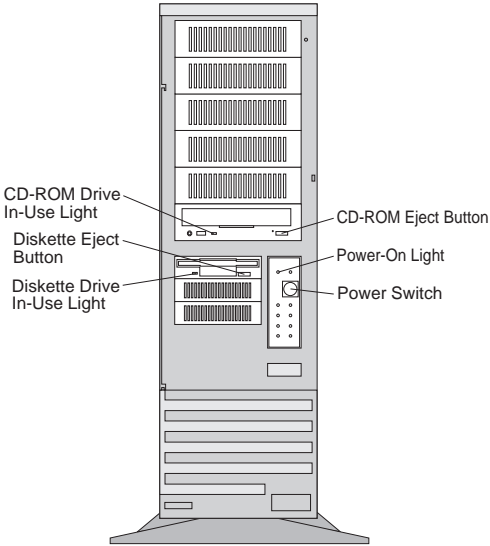

Controls and Indicators (Hot-Swap Server)

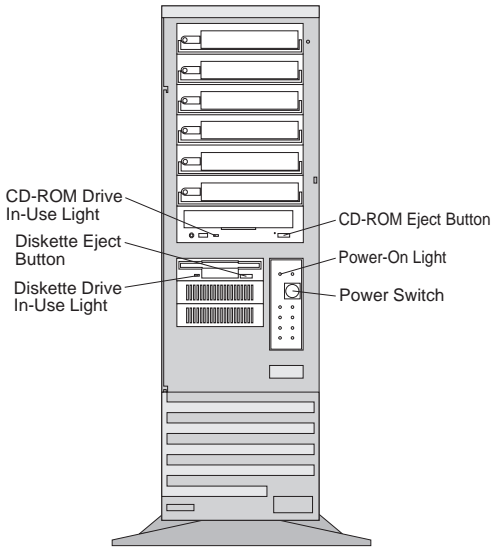

Controls Indicators Descriptions

CD-ROM Eject Button: Push this button to release the CD from the CD-ROM drive.

Power-On Light: This green LED lights when you power-on the server by pressing the power switch, and when the server powers on in the Unattended mode.

Power Switch: Use this switch to power-on the server manually, or return the server to *Standby mode*. The automatic restart feature, which enables the server to restart following a momentary power loss, means that the server is never completely powered-off.

Note

Do not set the server to the Standby mode if any of the drive In-Use lights are on. This might damage the information stored on a hard disk or diskette.

You can configure the server to start at a specified date and time, or when it receives a signal from either serial port. (For more information on setting Unattended startup, see “Alarm/Wakeup Settings” on page 30.)

To toggle the server:

- To the Attended mode from the Standby mode, press and release the power switch.
- Attended mode to the Standby mode, press the power switch in slowly just until the power-on light goes out, and then immediately release the switch.

Diskette-Drive In-Use Light: This light comes on when the drive is accessing a diskette.

Diskette Eject Button: Push this button to release a diskette from the drive.

CD-ROM Drive In-Use Light: This light comes on when the CD-ROM drive is accessed.

Card Guide

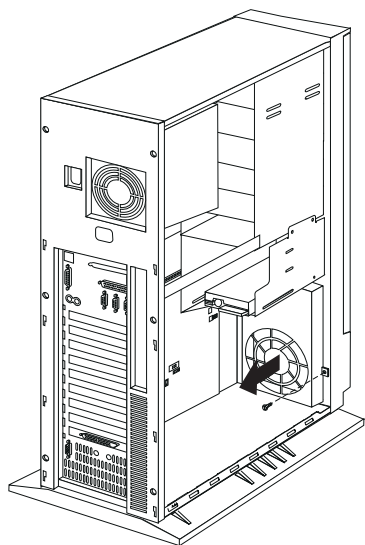

Cover (Top)

Note

The screws stay in place; do not attempt to remove them.

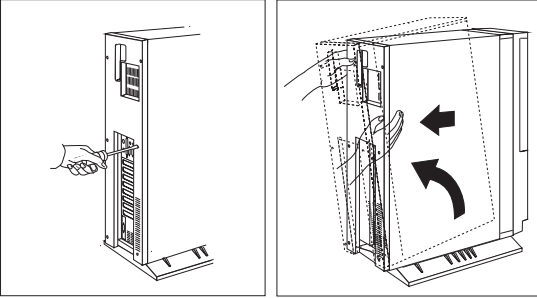

DASD Cage (3-Drive)

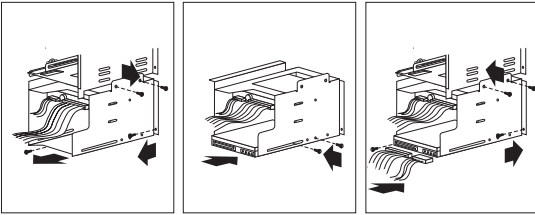

Door (Front)

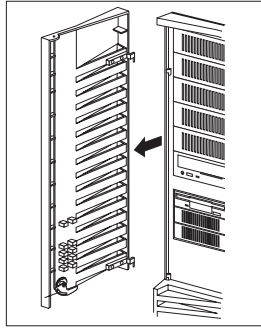
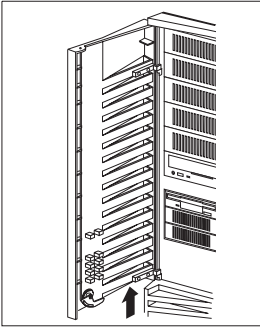

Drives (Non-Hot-Swap)

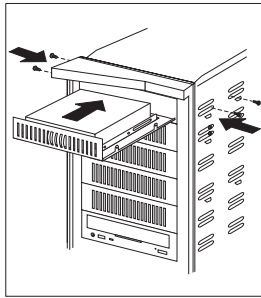
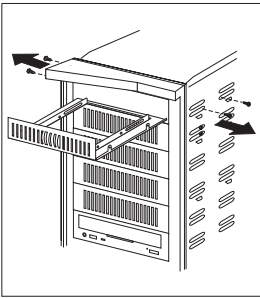

Drives (Hot-Swap)

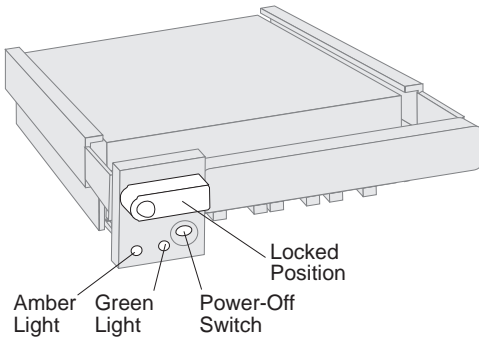

Light States

Green	Amber	Description
On	Off	Drive tray is powered on; the hard disk drive is inactive; and the drive should <i>not</i> be removed.
Blinking	Off	The hard disk drive is inactive. The hot-swap drive can be removed safely.
On	On or Blinking	The hard disk drive is in use, and should <i>not</i> be removed.
Off	Off	The drive is defective, or no power is being supplied to the drive. The hot-swap drive can be removed safely.

Expansion Slots

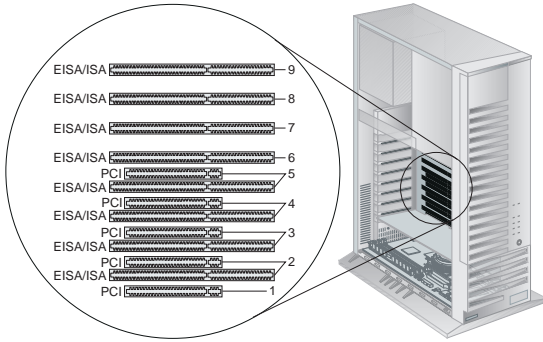

Front Bezel/Door Assembly

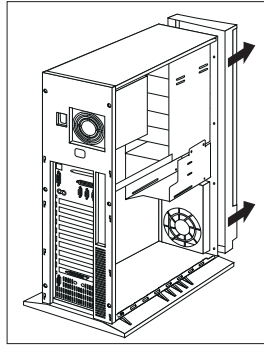
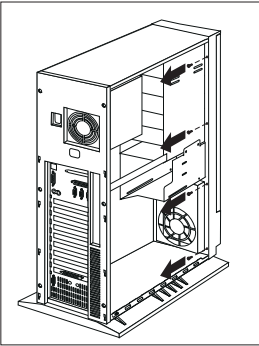
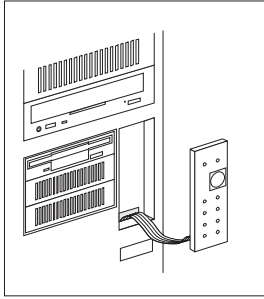
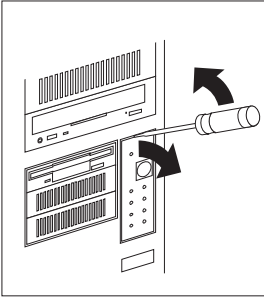

Input/Output Connectors

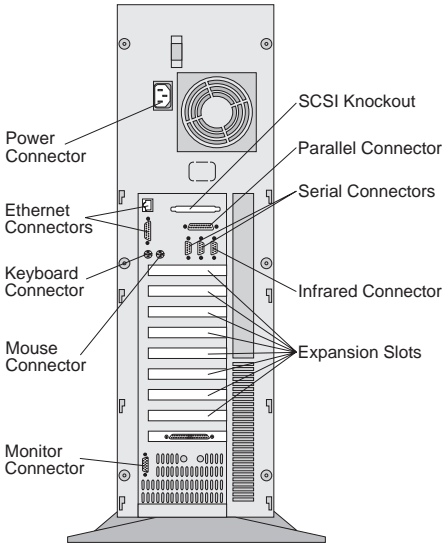

SCSI Knockout: Remove this knockout panel to install the SCSI external connector cable.



Parallel Connector: A signal cable for a parallel device, such as a printer, connects here.



Serial Connectors: Serial signal cables for modems or other serial devices connect here to the two 9-pin serial connectors, port A and port B. Serial port B shares a port assignment with the infra. port. See "Devices and I/O Ports" on page 28 for port assignment information.



Infrared Connector: An infrared (IR) transceiver module option can connect here. See "Devices and I/O Ports" on page 28 for port assignment information.

Expansion Slots: When you install an adapter into an expansion slot, remove the external expansion slot cover for any external connectors on the adapter.



Monitor Connector: The monitor signal cable connects here.



Mouse Connector: The mouse cable connects here. (Sometimes called the auxiliary-device port.)



Keyboard Connector: The keyboard cable connects here.



Ethernet Connectors: There are two Ethernet connectors: A DB-15 and an RJ-45. The DB-15 attachment unit interface (AUI) connector is for attachment of external 10BASE2, 10BASE5, or 10BASE-F medium attachment unit (MAU). The RJ-45 connector is for attachment to the integrated 10BASE-T (twisted-pair) transceiver. If the server was shipped with an Ethernet interface cable, you must attach it to the RJ-45 connector on the server, and the cable on the 10BASE-T device. For more information about cables, see “Ethernet Controller Messages” on page 45.

Power Connector: The server power cable connects here.

Internal Drive Bays (Non-Hot-Swap Servers)

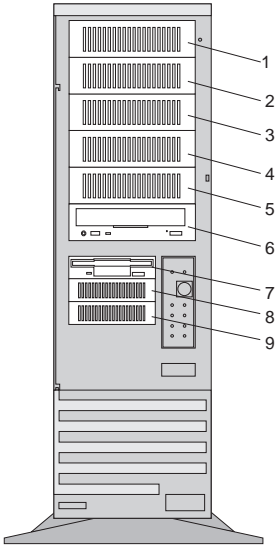

Maximum Allowable Drive Sizes (Non-Hot-Swap Models)

Bay	Drive Width	Drive Type	Maximum Drive Height
1-5	3.5-inch or 5.25-inch	Hard disk, removable media ^{See Note}	41.3 mm (1.6 inches)
6	5.25-inch	CD-ROM	41.3 mm (1.6 inches)
7	3.5-inch	Diskette drive	41.3 mm (1.6 inches)
8-9	3.5-inch	Hard disk, diskette, or 1/4-inch SCSI tape backup drive	25.4 mm (1 inch)
<p>Note: Removable media include 3.5-inch diskettes, optical discs, and tapes.</p>			

Required Hardware for Drive Options

Option	Required hardware
3.5-inch drive rewritable optical disc drive	Special mounting bracket
Internal drives, 3.5-inch	<ul style="list-style-type: none"><li data-bbox="295 261 487 282">• 8-bit or 16-bit drive<li data-bbox="295 289 409 310">• Drive tray
16-bit devices (bays 1–5)	16-bit cable (comes with the system)
8-bit devices	8-to-16 bit converter

Internal Drive Bays (Hot-Swap Servers)

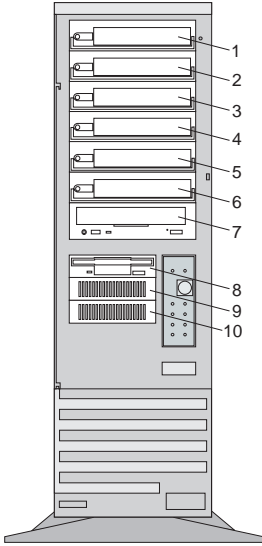

Maximum Allowable Drive Sizes (Hot-Swap Models)

Bay	Drive Width	Drive Type	Maximum Drive Height
1-6	3.5-inch	Hard disk, hot-swap	25.4 mm (1 inch)
7	5.25-inch	CD-ROM	41.3 mm (1.6 inches)
8	3.5-inch	Diskette	25.4 mm (1 inch)
9-10	3.5-inch	Hard disk, optical disc, SCSI diskette, 1/4-inch SCSI tape backup	41.3 mm (1.6 inches)

Required Hardware for Drive Options

Option	Required hardware
3.5-inch drive rewritable optical disc drive	<ul style="list-style-type: none">• Special mounting bracket
16-bit devices (bays 1 to 6)	<ul style="list-style-type: none">• Hot-swap drive tray III• 16-bit cable
Storage enclosure or external drives.	External SCSI-2 cable
8-bit device	68-to-50 pin converter

Memory Module

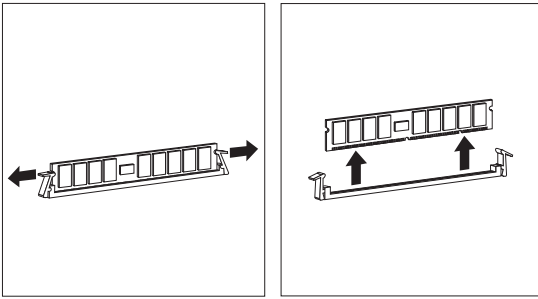

Operator Panel

Note

Loosen, do not remove the screw.

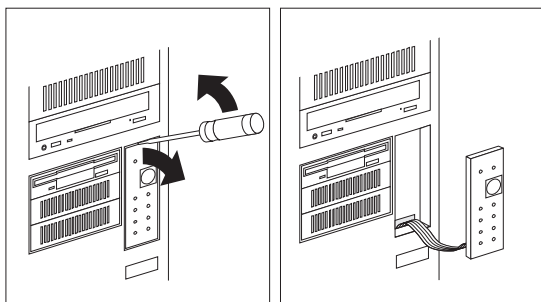
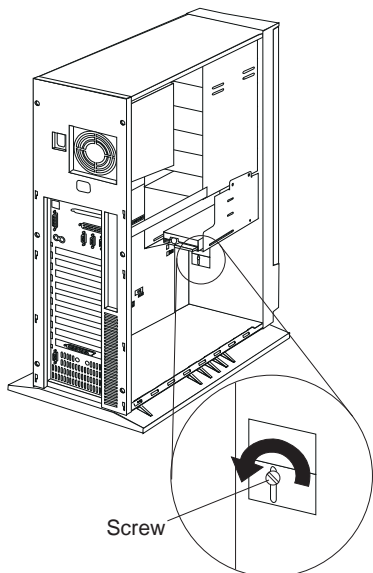

Operator Panel Status Indicators

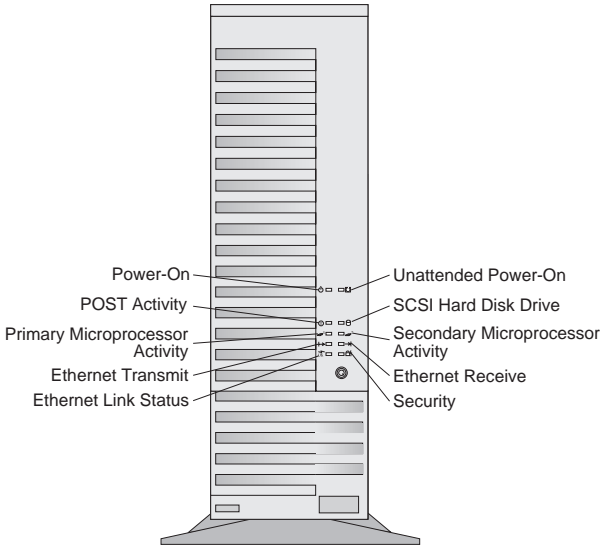

Unattended Power-On Indicator:

This green LED lights when the server powers on in the Unattended mode.



SCSI Hard Drive In-Use Indicator:

This amber LED lights when your server is accessing a SCSI device. If this light remains illuminated, this might indicate that either the SCSI bus or the system microprocessor has stopped.



Secondary Microprocessor In-Use Indicator:

This amber LED blinks to show the activity of a microprocessor installed in the secondary microprocessor socket. The LED lights during POST to indicate the presence of the microprocessor. When you install a secondary microprocessor, it becomes the startup microprocessor.



Ethernet Receive Indicator:

This amber LED shows reception activity on the network.



Security Indicator: When tamper-detection software is installed and enabled, this amber LED shows that a security hardware or software error occurred.



Ethernet Link Status Indicator: This green LED shows an active link connection on the 10BASE-T interface.



Ethernet Transmit Indicator: This amber LED shows transmission activity on the network.



Primary Microprocessor Activity Indicator: This amber LED blinks to indicate the activity of the microprocessor; it also comes on during POST.



POST Activity Indicator: This amber LED lights while the power-on self test (POST) and the configuration utility programs are running. If this LED remains illuminated, either a POST error has occurred, or the system microprocessor has stopped.



Power-On Indicator: This green LED lights when you turn on your server by pressing the power switch, and when the server powers on in the Unattended mode.

Optional Processor

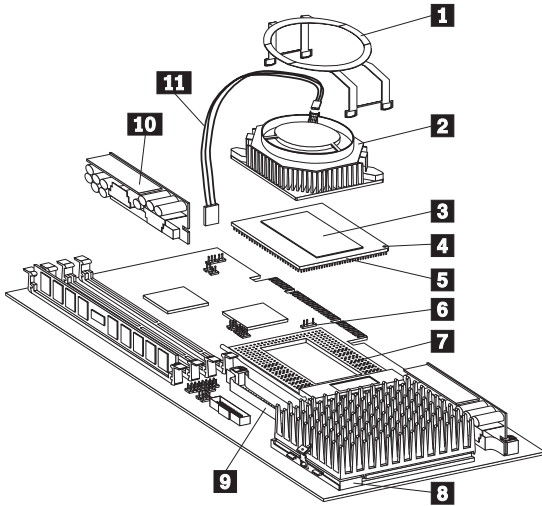

- 1** Fan sink retention clip
- 2** Fan sink
- 3** Heat spreader
- 4** Pin 1 location
- 5** Microprocessor
- 6** Fan power cable connector (J21)
- 7** Secondary processor board socket, empty, with lever in closed, locked position.
- 8** Primary processor board socket, with lever in closed position
- 9** Secondary VRM connector
- 10** Voltage regulator module (VRM)
- 11** Fan power cable

Retention Bracket

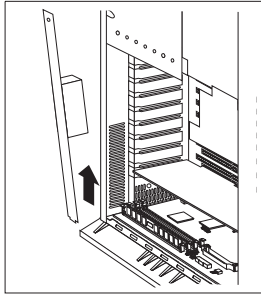
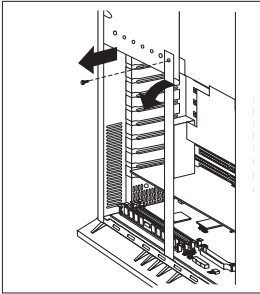
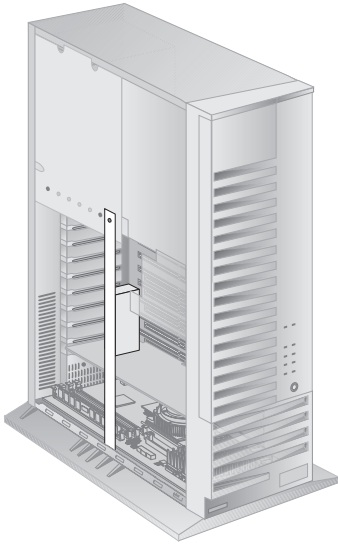

Processor Board

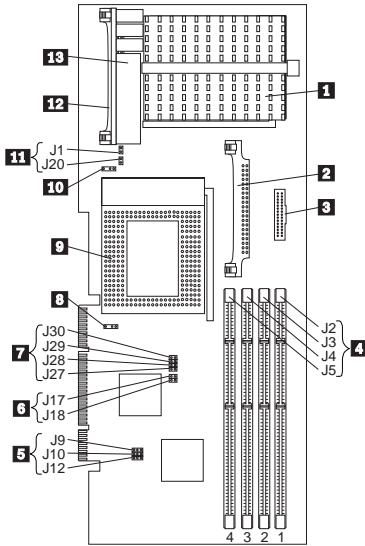

- 1** Primary Microprocessor Connector
- 2** Secondary Voltage Regulator Connector
- 3** Reserved
- 4** Memory Connectors (J2, J3, J4, J5)
- 5** Reserved (J9, J10, J12)
- 6** PMC Frequency Selection Jumpers (J17, J18)
- 7** Clock Ratio Jumpers (J27, J28, J29, J30)
- 8** Secondary Microprocessor Fan Connector (J21)
- 9** Secondary Microprocessor Connector
- 10** Primary Microprocessor Fan Connector (J22)
- 11** Clock Frequency Jumpers (J1, J20)
- 12** Primary Voltage Regulator Module Connector
- 13** Voltage Regulator Module











Processor Board Jumpers

Attention

























If the microprocessor bus-to-core ratio is incorrect, system board components will overheat and component damage can occur. Be sure that the microprocessor bus-to-core ratio jumper is properly set.

When you install a microprocessor, check the jumper settings carefully. Make sure that the setting for the clock speed jumper matches the clock speed of the microprocessor that you installed.

Operating Parameters Jumpers

Identifier	Default Jumper Position	Description
J1 J20	 	Clock speed jumper block. The default setting is 66.66 MHz. Use the appropriate microprocessor clock speed for the microprocessor you have installed.
J30 J29 J28 J27	   	Frequency selection jumper block. The default Core/Bus fraction is 3 (200/66 MHz).
J17 J18	 	Microprocessor memory controller (PMC) frequency selection jumper block. The default is 66.66 MHz.
J9 J10 J12	  	Reserved

Frequency Jumpers

Speed (in MHz)	Multiplier	Clock Speed	PMC Frequency
200/66.66	J30  J29  J28  J27 	J1  J20 	J17  J18 
180/60	J30  J29  J28  J27 	J1  J20 	J17  J18 
166/66.66	J30  J29  J28  J27 	J1  J20 	J17  J18 

System Board

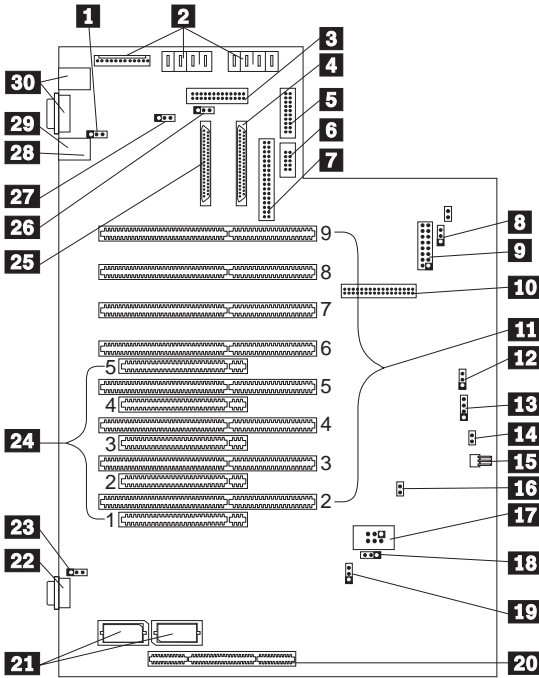

- 1** Ethernet Enable Jumper (J22)
- 2** Power Connectors
- 3** Parallel Connector
- 4** Internal SCSI Connector
- 5** Serial Connector
- 6** Infrared Connector
- 7** Diskette Drive Connector
- 8** 5 Volt Select Jumper (J33)
- 9** Operator Panel Connector
- 10** Reserved
- 11** EISA/ISA Slots
- 12** Flash Enable Jumper (J39)
- 13** Speaker Connector
- 14** Reserved
- 15** System Fan Power Connector
- 16** System Reset (J27)
- 17** C2 Security Cable Connector
- 18** System Management Enable Jumper (J49)
- 19** Power-On Password Jumper (J12)
- 20** Processor Board Connector
- 21** Video RAM Sockets
- 22** Video Connector
- 23** Video Enable Jumper (J25)
- 24** PCI Slots
- 25** External SCSI Connector (J29)
- 26** SCSI Bus Termination Jumper (J38)

27

SCSI Controller Enable Jumper (J26)

28

Mouse Connector

29

Keyboard Connector

30

Ethernet Connectors

System Board Jumper Settings

Jumper	Description	Setting
J12	Power-on password reset For instructions on resetting the power-on password, see "Bypassing an Unknown Power-on Password" on page 21.	Pins 2-3 (default)
J22	Ethernet controller enabled Ethernet controller disabled	Pins 2-3 (default) Pins 1-2
J25	Video controller enabled Video controller disabled	Pins 1-2 (default) Pins 2-3
J26	SCSI controller enabled SCSI controller disabled	Pins 2-3 (default) Pins 1-2
J38	External SCSI termination enabled External SCSI termination disabled	Pins 2-3 (default) Pins 1-2
J39	Flash update jumper enabled Flash update jumper disabled	Pins 2-3 (default) Pins 1-2
J49	System Management Adapter (not installed) System Management Adapter (installed)	Pins 1-2 Pins 2-3

U-Bolt

Note

Thread the cable through the U-bolt and around an object that is not a part of or permanently secured to the building structure or foundation, and from which it cannot be removed; then fasten the cable ends together with a lock.

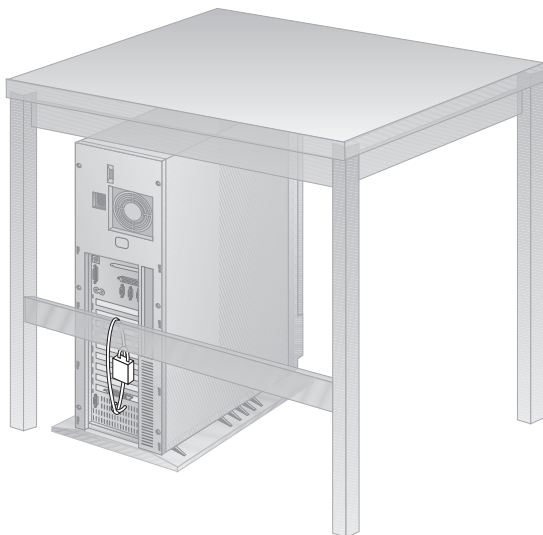
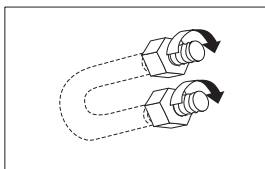
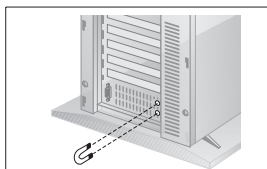

Symptom-to-FRU Index

This index supports PC Server 330 Type 8640 computers.

Always start with “General Checkout” on page 2.

The Symptom-to-FRU lists symptoms, errors, and the possible causes. The most likely cause is listed first. Use this Symptom-to-FRU Index to help you decide which FRUs to have available when servicing the computer.

In the following error codes and model numbers, X can be any number or letter.

Where the model number is used to identify an error, XX used in place of the last 2 digits can be any number or letter.

Note

For IBM devices not supported by the QAPlus/PRO diagnostics code, refer to the manual for that device.

For information on:	Go to:
Additional service help. (For example, 0S/2 Trap)errors, or	“Related Service Information” on page 181.
Possible software and hardware mismatch problems. (Not repairable by replacing FRUs)	“Resolving Configuration Conflicts” on page 41.
Replacing the system board does not correct the problem.	See “System/Processor Board Replacement” on page 133.

No Beep Symptoms

No Beep/Symptom	FRU/Action
No Beeps occur after successfully completing POST	<ol style="list-style-type: none">1. Disconnected speaker2. Speaker3. System board

Beep Symptoms

Beep symptoms are short tones or a series of short tones separated by pauses (intervals without sound). See the following examples.

Beeps	Description
1-2-X	<ul style="list-style-type: none">• One beep• A pause (or break)• Two beeps• A pause (or break)• Any number of beeps
4	Four continuous beeps

Beep/Symptom	FRU/Action
1-1-2 (Microprocessor register test failed)	<ol style="list-style-type: none"> 1. Optional Microprocessor (if installed) 2. Microprocessor
1-1-3 (CMOS write/read test failed)	<ol style="list-style-type: none"> 1. Battery/CMOS chip 2. System board
1-1-4 (BIOS ROM checksum failed)	<ol style="list-style-type: none"> 1. System board
1-2-1 (Programmable Interval Timer failed)	<ol style="list-style-type: none"> 1. System board 2. Microprocessor board
1-2-2 (DMA initialization failed)	<ol style="list-style-type: none"> 1. System board 2. Microprocessor board
1-2-3 (DMA page register write/read failed)	<ol style="list-style-type: none"> 1. System board 2. Microprocessor board
1-2-4 RAM refresh verification failed	<ol style="list-style-type: none"> 1. System board 2. Microprocessor board
1-3-1 (1st 64K RAM test failed)	<ol style="list-style-type: none"> 1. DIMM 2. Microprocessor board
1-3-2 (1st 64K RAM parity test failed)	<ol style="list-style-type: none"> 1. DIMM 2. Microprocessor board 3. System board
2-1-1 (Secondary DMA register failed)	<ol style="list-style-type: none"> 1. System board 2. Microprocessor board
2-1-2 (Primary DMA register failed)	<ol style="list-style-type: none"> 1. System board 2. Microprocessor board
2-1-3 (Primary interrupt mask register failed)	<ol style="list-style-type: none"> 1. System board 2. Microprocessor board
2-1-4 (Secondary interrupt mask register failed)	<ol style="list-style-type: none"> 1. System board 2. Microprocessor board
2-2-1 (Interrupt vector loading failed)	<ol style="list-style-type: none"> 1. System board 2. Microprocessor board
2-2-2 (Keyboard controller failed)	<ol style="list-style-type: none"> 1. System board
2-2-3 (CMOS power failure and checksum checks failed)	<ol style="list-style-type: none"> 1. Battery/CMOS chip 2. System board
2-2-4 (CMOS configuration info validation failed)	<ol style="list-style-type: none"> 1. Battery/CMOS chip 2. System board
2-3-1 (Screen initialization failed)	<ol style="list-style-type: none"> 1. System board

Beep/Symptom	FRU/Action
2-3-2 (Screen memory failed)	1. System board
2-3-3 (Screen retrace failed)	1. System board
2-3-4 (Search for video ROM failed)	1. System board
2-4-1 (Video failed, screen believed operable)	1. System board
3-1-1 (Timer tick interrupt failed)	1. System board
3-1-2 (Interval timer channel 2 failed)	1. System board
3-1-3 (RAM test failed above address 0FFFFH)	1. DIMM 2. Microprocessor board 3. System board
3-1-4 (Time-Of-Day clock failed)	1. Battery/CMOS chip 2. System board
3-2-1 (Serial port failed)	1. System board
3-2-2 (Parallel port failed)	1. System board
3-2-3 (Math coprocessor failed)	1. Optional Microprocessor (if installed) 2. Microprocessor 3. Microprocessor board
3-2-4 (Failure comparing CMOS memory size against actual)	1. DIMM 2. Microprocessor board 3. Battery/CMOS chip
3-3-1 (Memory size mismatch occurred)	1. DIMM 2. Microprocessor board 3. Battery/CMOS chip
Three Short Beeps	1. DIMM 2. Microprocessor board 3. System board
One Continuous Beep	1. Optional Microprocessor (if installed) 2. Microprocessor 3. Microprocessor board 4. System board
Repeating Short Beeps	1. Keyboard 2. System board
One Long and One Short Beep	1. Video adapter (if present) 2. System Board 3.

Beep/Symptom	FRU/Action
One Long and Two Short Beeps	<ol style="list-style-type: none">1. Video adapter (if present)2. System Board
Two Long and Two Short Beeps	<ol style="list-style-type: none">1. Video adapter

Error Codes

In the following error codes, X can be any number or letter.

Error Code/Symptom	FRU/Action
E100, E101 (Invalid EISA configuration)	<ol style="list-style-type: none"> 1. Run EISA Configuration 2. Failing EISA adapter 3. Battery/CMOS chip 4. System Board
E10X (Invalid EISA configuration for Slot X)	<ol style="list-style-type: none"> 1. Run EISA Configuration 2. Failing EISA adapter in slot X
101, 102 (System and microprocessor error)	<ol style="list-style-type: none"> 1. System Board 2. Microprocessor board
106 (System and microprocessor error)	<ol style="list-style-type: none"> 1. System Board 2. Microprocessor board
111 (I/O channel check error)	<ol style="list-style-type: none"> 1. Failing EISA/ISA Adapter 2. Memory DIMM 3. System Board
114 (Adapter read-only memory error)	<ol style="list-style-type: none"> 1. Failing Adapter 2. Run Diagnostics
129 (Internal Cache error)	<ol style="list-style-type: none"> 1. Optional Microprocessor (if installed) 2. Microprocessor 3. Microprocessor board
151 (Real time clock error)	<ol style="list-style-type: none"> 1. Run Diagnostics 2. Battery/CMOS chip 3. System Board
162 (Device Configuration Error)	<ol style="list-style-type: none"> 1. Run Configuration/Setup; then, run the EISA Configuration Utility 2. Failing Device 3. Battery/CMOS Chip 4. System Board
163 (Real-Time Clock error)	<ol style="list-style-type: none"> 1. Run Configuration/Setup 2. Battery/CMOS Chip 3. System Board
164 (Memory configuration changed)	<ol style="list-style-type: none"> 1. Run Configuration/Setup 2. DIMM 3. Microprocessor Board
173 (System CMOS checksum bad)	<ol style="list-style-type: none"> 1. Run Configuration/Setup 2. Battery/CMOS Chip 3. System Board

Error Code/Symptom	FRU/Action
175 (Hardware error)	<ol style="list-style-type: none"> 1. System board 2. Microprocessor board
176 (Computer cover or cable cover was removed without a key being used)	<ol style="list-style-type: none"> 1. Run Configuration/Setup
177, 178 (Security hardware error)	<ol style="list-style-type: none"> 1. Run Configuration/Setup 2. System Board
182 (System board error)	<ol style="list-style-type: none"> 1. System board
183 (Administration password not entered)	<ol style="list-style-type: none"> 1. System board
184 (Power-on password corrupted)	<ol style="list-style-type: none"> 1. Run Configuration/Setup 2. System board
185 (Drive startup sequence information corrupted)	<ol style="list-style-type: none"> 1. Run Configuration/Setup 2. System board
186 (System board or security hardware error)	<ol style="list-style-type: none"> 1. Run Configuration/Setup 2. System Board
187 (System board or security hardware error)	<ol style="list-style-type: none"> 1. System board
188 (System board or security hardware error)	<ol style="list-style-type: none"> 1. System board
189 (An attempt was made to access the server with invalid passwords)	<ol style="list-style-type: none"> 1. Run Configuration/Setup, enter the administrator password
201 (Memory test error)	<ol style="list-style-type: none"> 1. DIMM 2. Processor Board 3. System Board
229 (Cache error)	<ol style="list-style-type: none"> 1. Optional Microprocessor (if installed) 2. Microprocessor 3. Microprocessor board
301 (Keyboard or keyboard controller error)	<ol style="list-style-type: none"> 1. Keyboard 2. System Board
604 (Diskette drive error)	<ol style="list-style-type: none"> 1. Run Configuration/Setup and Diagnostics 2. Diskette Drive 3. Drive Cable 4. System Board

Error Code/Symptom	FRU/Action
605 (Diskette Unlock failure)	<ol style="list-style-type: none"> 1. Diskette Drive 2. Drive Cable 3. System Board
662 (Diskette drive configuration error)	<ol style="list-style-type: none"> 1. Run Configuration/Setup and Diagnostics 2. Diskette Drive 3. Drive Cable 4. System Board
962 (Parallel port error)	<ol style="list-style-type: none"> 1. Disconnect external cable on parallel port. 2. Run Configuration/Setup 3. System Board
11XX (System-board serial port 1 or 2 error)	<ol style="list-style-type: none"> 1. Disconnect external cable on serial port. 2. Run Configuration/Setup 3. System board
1762 (Fixed Disk Configuration error)	<ol style="list-style-type: none"> 1. Fixed Disk Cables 2. Run Configuration/Setup 3. Fixed Disk Adapter 4. Fixed Disk Drive 5. System Board
178X (Fixed Disk error)	<ol style="list-style-type: none"> 1. Fixed Disk Cables 2. Run Diagnostics 3. Fixed Disk Adapter 4. Fixed Disk Drive 5. System Board
1800 (No more hardware interrupt available for PCI adapter)	<ol style="list-style-type: none"> 1. Run Configuration/Setup 2. Run EISA Configuration 3. Failing Adapter 4. System Board
1801 (No room for PCI option ROM)	<ol style="list-style-type: none"> 1. Run Configuration/Setup 2. Run EISA Configuration 3. Failing Adapter 4. System Board
1802 (No more I/O space available for PCI adapter)	<ol style="list-style-type: none"> 1. Run Configuration/Setup 2. Failing Adapter 3. System Board
1803 (No more memory (above 1MB for PCI adapter)	<ol style="list-style-type: none"> 1. Run Configuration/Setup 2. Failing Adapter 3. System Board

Error Code/Symptom	FRU/Action
1804 (No more memory (below 1MB for PCI adapter))	<ol style="list-style-type: none"> 1. Run Configuration/Setup 2. Move failing adapter to slot 1 or 2 3. Failing Adapter 4. System Board
1805 (PCI option ROM checksum error)	<ol style="list-style-type: none"> 1. Remove Failing PCI Card 2. System Board
1806 (PCI to PCI Bridge error)	<ol style="list-style-type: none"> 1. Run Configuration/Setup 2. Move failing adapter to slot 1 or 2 3. Failing Adapter 4. System Board
2400 (Video controller test failure)	<ol style="list-style-type: none"> 1. Video Adapter (if installed) 2. System Board
2462 (Video memory configuration error)	<ol style="list-style-type: none"> 1. Video Adapter (if installed) 2. System Board
8603 (Pointing Device Error)	<ol style="list-style-type: none"> 1. Pointing Device 2. System Board
19990301 (Fixed boot sector error, no operating system installed)	<ol style="list-style-type: none"> 1. Run Configuration/Setup for correct startup 2. Verify operating system installed
19990305 (Fixed boot sector error, no operating system installed)	<ol style="list-style-type: none"> 1. Install operating system to hard disk drive.

Parts Listings (PC Server 330 - Type 8640)

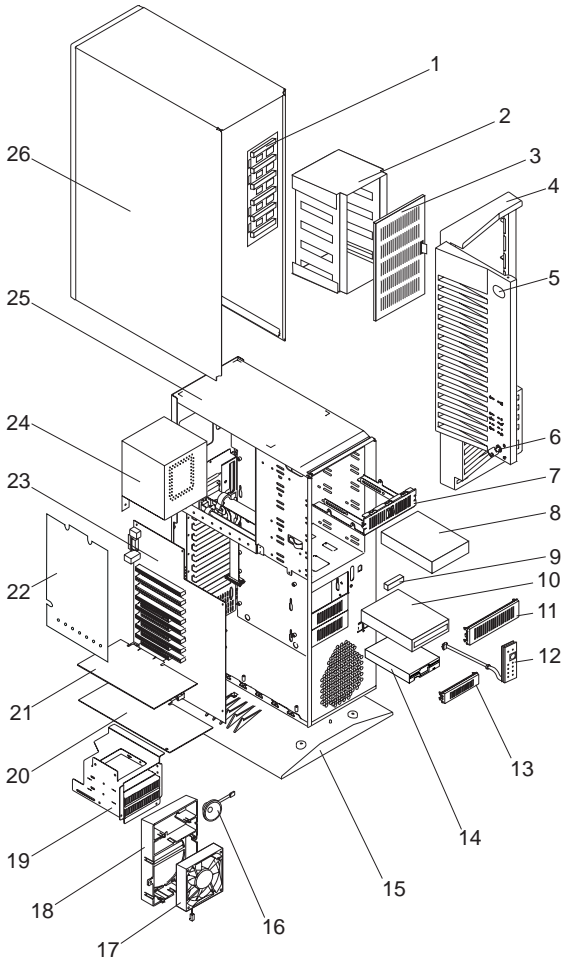

System

Note

The model(s) listed for the following FRUs indicates FRUs that the models may contain at the time of shipping or supported options.

Index	System (Server 330 - Type 8640)	FRU No.
1	DASD Hot Swap Backplane (Models EM2, ES2, ESS)	06H8576
2	Hot Swap Shell (Models EM2, ES2, ESS)	06H5068
3	Hot Swap Door Assembly (Models EM2, ES2, ESS)	06H5070
4	Front Bezel/Door Assembly (Models EM2, ES0, ES2, ESS)	60H7061
5	PC Server 330 Label (Models EM2, ES0, ES2, ESS)	75H8324
6	Keylock, with Keys (Models EM2, ES0, ES2, ESS)	33F8433
7	DASD Tray (Models EM2, ES2, ESS)	06H8631
8	2GB Hard Disk Drive Fast/Wide 1X (Model ESS)	76H0958
9	CD-ROM 16/8 Bit SCSI Converter (Models EM2, ES0, ES2, ESS)	92F0324
10	MKE CR-504 8X SCSI CD-ROM Drive (Models EM2, ES0, ES2, ESS)	73H2601
11	5.25-Inch Blank Bezel (Model ES0)	71G0771
12	LED/On/Off Switch Cable Assembly (Operator Panel) (Models EM2, ES0, ES2, ESS)	55H8168
13	3.5-Inch Blank Vented Bezel (Models EM2, ES0, ES2, ESS)	55H8174
14	1.44MB Diskette Drive (Models EM2, ES0, ES2, ESS)	93F2361
15	Pedestal (Models EM2, ES0, ES2, ESS)	96G2412
16	Speaker (Models EM2, ES0, ES2, ESS)	06H2649
17	Fan Assembly, with Connector (Models EM2, ES0, ES2, ESS)	76H3447
18	Card Guide (Models EM2, ES0, ES2, ESS)	60H7065
19	DASD 3-Drive Cage (Models EM2, ES0, ES2, ESS)	60H7064
20	Processor Board with Voltage Regulator, without Processor Chip (Models EM2, ES0, ES2, ESS)	75H7419
21	PC Server RAID Adapter (Model ESS)	06H9334
22	Air Baffle (Models EM2, ES0, ES2, ESS)	76H3467

Index	System (Server 330 - Type 8640)	FRU No.
23	System Board, without Memory, Processor Card (Models EM2, ES0, ES2, ESS)	75H7432
24	350W 3.3v Power Supply Assembly (Models EM2, ES0, ES2, ESS)	75H8479
25	Base Frame (Models EM2, ES0, ES2, ESS)	60H7062
26	Access Cover (Models EM2, ES0, ES2, ESS)	60H7063
	32MB ECC 3.3v DIMM (Models EM2, ES0, ES2, ESS)	12J4121
	64MB ECC 3.3v Buffer DIMM (Models EM2, ES0, ES2, ESS)	12J4122
	128MB ECC 3.3v Buffer DIMM (Models EM2, ES0, ES2, ESS)	76H0656
	256MB ECC 3.3v Buffer DIMM (Models EM2, ES0, ES2, ESS)	12J4123
	Fan Sink with Tape and Clip (Models EM2, ES0, ES2, ESS)	76H1813
	Heat Sink, with Tape, Clip (Models EM2, ES0, ES2, ESS)	76H1814
	Keyboard with Cables, see "Keyboards (101/102 Key)" on page 178.	
	Miscellaneous Parts Kit (Models EM2, ES0, ES2, ESS)	55H8179
	<ul style="list-style-type: none"> • 32X5/16" Screws (6 each) • Diskette Drive M3 Screws (2 each) • EMC Contact (1 each) • EMC Ground Contacts (4 each) • FEM-Nut 4-40 Screws (2 each) • Hard Disk Drive 6-32 Screws (2 each) • I/O Blank (1 each) • Plastic Rivets (3 each) • Power Switch Bracket (1 each) • System Board Edge Support (1 each) • System Board M3X8 HEX Screws (3 each) 	
	Mouse (Models EM2, ES0, ES2, ESS)	06H4595
	P6 66/200 MHz Processor Chip with 256K Internal Cache, Heat Sink, and grease (Models ES0, ES2, ESS)	75H9831
	P6 66/200 MHz Processor Chip with 512K Internal Cache, Heat Sink, and grease (Model EM2)	12J3501
	Power Cord, see "Power Cords" on page 179.	
	Real Time Clock with Battery (Models EM2, ES0, ES2, ESS) See "Battery Notice" on page 187 before replacing this FRU.	82G3620

Index	System (Server 330 - Type 8640)	FRU
	Service Processor Card (PC Server Advanced Systems Management Adapter) (Models EM2, ES0, ES2, ESS)	76H3240
	Shadow Box (Models EM2, ES0, ES2, ESS)	60H7066
	Voltage Regulator - 11.2 amp. (Models ES0, ES2, ESS)	76H1815
	<p style="text-align: center;">Note</p> <p>Use this FRU with processors that have 256K of internal cache only.</p>	
	Voltage Regulator - 12.4 amp. (Model EM2)	07H1097
	<p style="text-align: center;">Note</p> <p>This FRU must be used with Processor FRU 12J3501 which has 512K of internal cache. It can also be used with Processor FRU 75H9831 if Voltage Regulator FRU 76H1815 is not available.</p>	

Cables

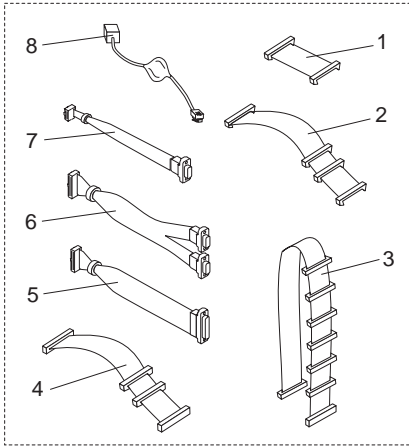

Index	Cables (Server 330 - Type 8640)	FRU No.
1	SCSI Hard Disk Drive Fast Cable 1X (Models EM2, ES2, ESS)	76H3453
2	SCSI Hard Disk Fast Cable 3X (Models EM2, ES2, ESS)	76H3455
3	SCSI Hard Disk Drive Fast/Wide Cable (7X) (Models ES0)	55H8192
4	Diskette Drive Signal Cable with Power (Models EM2, ES0, ES2, ESS)	92F0423
5	Parallel Data Cable (Models EM2, ES0, ES2, ESS)	55H8206
6	Y Serial Data Cable (Models EM2, ES0, ES2, ESS)	55H8204
7	Infrared Data Cable (Models EM2, ES0, ES2, ESS)	55H8194
8	Ethernet Pigtail Cable (Models EM2, ES0, ES2, ESS)	76H3480

Keyboards (101/102 Key)

Keyboards (101/102 key)

	FRU No.
Arabic	1391490
Belgium-Dutch	1391414
Belgium-French	1391526
Bulgarian	1399583
Czech	1399570
Danish	1391407
Dutch	1391511
Finnish	1391411
French	1391402
German	1391403
Greek	1399046
Hebrew	1391408
Hungarian	1399581
Iceland	1391495
Italy	1393395
Latvia	1391406
Norwegian	1391409
Polish	1399580
Portuguese	1391410
Romanian	1399582
Russian-Cyrillic	1399579
Serbian-Cyrillic	1399578
Slovak	1399571
Slovenia/Croatia/Bosnia	1393669
South Africa	1396790
Spanish	1391405
Swedish	1391411
Swiss-French	1391412
Swiss-German	1391412
Turkish 179	8125409
Turkish 440	1393286
U.K. English	1391406
U.S. English	75H9505
U.S. English (E/ME/A only)	1396790

Power Cords

Power Cords (PC Server 330 Type 8640)

	FRU No.
Arabic	14F0033
Belgium	1339520
Bulgaria	1339520
Czech Republic	1339520
Denmark	13F9997
Finland	1339520
France	1339520
Germany	1339520
Hungary	1339520
Israel	14F0087
Italy	14F0069
Latvia	1339520
Netherlands	1339520
Norway	1339520
Poland	1339520
Portugal	1339520
Serbia	1339520
Slovakia	1339520
South Africa	14F0015
Spain	1339520
Switzerland	1339520
Switzerland (French/German)	14F0051
U.S. English	62X1045
U.K./Ireland	14F0033
Yugoslavia	1339520

Parts Listing (PC Server Advanced Systems Management Adapter)

Index	PC Server Advanced Systems Management Adapter	FRU No.
	PC Server Advanced Systems Management Adapter (Service Processor Adapter)	76H3240
	Lithium battery (See "Battery Notice" on page 187)	33F8354
	External Power Control Unit	71G6222

Cables

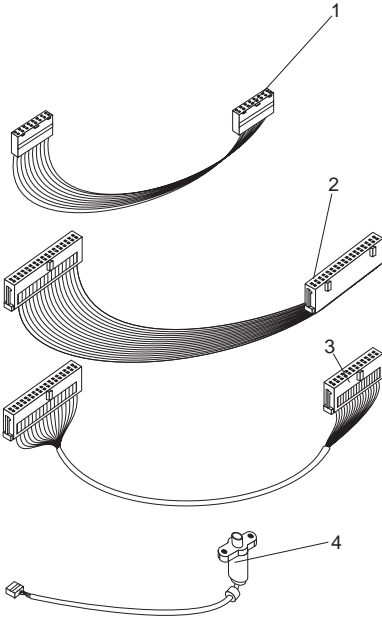

Index	Cables (PC Server Advanced Systems Management Adapter)	FRU No.
1	16-pin Interface Cable	76H6827
2	34-pin Interface Cable	76H3257
3	34/26-pin Interface Cable	76H6828
4	Processor Adapter External Power Connector Cable	76H4054

Related Service Information

Important

The service procedures are designed to help you isolate problems. They are written with the assumption that you have model-specific training on all computers, or that are familiar with the computers, functions, terminology, and service information provided in this supplement and the PC Servers Hardware Maintenance Manual (part number 70H0751, form number S30H-2501-01). Refer to the PC Servers Hardware Maintenance Manual (part number 70H0751, form number S30H-2501-01) for additional related service information.

Safety Information	182
General Safety	182
Electrical Safety	183
Safety Inspection Guide	184
Handling Electrostatic Discharge-Sensitive Devices	186
Grounding Requirements	186
Battery Notice	187
Software/Hardware Mismatch Problems	188
Laser Compliance Statement	190
Problem Determination Tips	191
Phone Numbers, U.S. and Canada	192
Notices	194
Trademarks	194

Safety Information

The following section contains the safety information that you need to be familiar with before servicing an IBM mobile computer.

General Safety

Follow these rules to ensure general safety:

- Observe good housekeeping in the area of the machines during and after maintenance.
- When lifting any heavy object:
 1. Ensure you can stand safely without slipping.
 2. Distribute the weight of the object equally between your feet.
 3. Use a slow lifting force. Never move suddenly or twist when you attempt to lift.
 4. Lift by standing or by pushing up with your leg muscles; this action removes the strain from the muscles in your back. *Do not attempt to lift any objects that weigh more than 16 kg (35 lb) or objects that you think are too heavy for you.*
- Do not perform any action that causes hazards to the customer, or that makes the equipment unsafe.
- Before you start the machine, ensure that other service representatives and the customer's personnel are not in a hazardous position.
- Place removed covers and other parts in a safe place, away from all personnel, while you are servicing the machine.
- Keep your tool case away from walk areas so that other people will not trip over it.
- Do not wear loose clothing that can be trapped in the moving parts of a machine. Ensure that your sleeves are fastened or rolled up above your elbows. If your hair is long, fasten it.
- Insert the ends of your necktie or scarf inside clothing or fasten it with a nonconductive clip, approximately 8 centimeters (3 inches) from the end.
- Do not wear jewelry, chains, metal-frame eyeglasses, or metal fasteners for your clothing.

Remember: Metal objects are good electrical conductors.

- Wear safety glasses when you are: hammering, drilling soldering, cutting wire, attaching springs, using solvents, or working in any other conditions that might be hazardous to your eyes.
- After service, reinstall all safety shields, guards, labels, and ground wires. Replace any safety device that is worn or defective.
- Reinstall all covers correctly before returning the machine to the customer.

Electrical Safety

Observe the following rules when working on electrical equipment.

Important

Use only approved tools and test equipment. Some hand tools have handles covered with a soft material that does not insulate you when working with live electrical currents.

Many customers have, near their equipment, rubber floor mats that contain small conductive fibers to decrease electrostatic discharges. Do not use this type of mat to protect yourself from electrical shock.

- Find the room emergency power-off (EPO) switch, disconnecting switch, or electrical outlet. If an electrical accident occurs, you can then operate the switch or unplug the power cord quickly.
- Do not work alone under hazardous conditions or near equipment that has hazardous voltages.
- Disconnect all power before:
 - Performing a mechanical inspection
 - Working near power supplies
 - Removing or installing main units
- Before you start to work on the machine, unplug the power cord. If you cannot unplug it, ask the customer to power-off the wall box that supplies power to the machine and to lock the wall box in the off position.
- If you need to work on a machine that has *exposed* electrical circuits, observe the following precautions:
 - Ensure that another person, familiar with the power-off controls, is near you.

Remember: Another person must be there to switch off the power, if necessary.
 - Use only one hand when working with powered-on electrical equipment; keep the other hand in your pocket or behind your back.

Remember: There must be a complete circuit to cause electrical shock. By observing the above rule, you may prevent a current from passing through your body.
 - When using testers, set the controls correctly and use the approved probe leads and accessories for that tester.
 - Stand on suitable rubber mats (obtained locally, if necessary) to insulate you from grounds such as metal floor strips and machine frames.

Observe the special safety precautions when you work with very high voltages; these instructions are in the safety sections of maintenance information. Use extreme care when measuring high voltages.

- Regularly inspect and maintain your electrical hand tools for safe operational condition.
- Do not use worn or broken tools and testers.
- *Never assume* that power has been disconnected from a circuit. First, *check* that it has been powered-off.
- Always look carefully for possible hazards in your work area. Examples of these hazards are moist floors, nongrounded power extension cables, power surges, and missing safety grounds.
- Do not touch live electrical circuits with the reflective surface of a plastic dental mirror. The surface is conductive; such touching can cause personal injury and machine damage.
- Do not service the following parts *with the power on* when they are removed from their normal operating places in a machine:
 - Power supply units
 - Pumps
 - Blowers and fans
 - Motor generators

and similar units. (This practice ensures correct grounding of the units.)

- If an electrical accident occurs:
 - **Use caution; do not become a victim yourself.**
 - **Switch off power.**
 - **Send another person to get medical aid.**

Safety Inspection Guide

The intent of this inspection guide is to assist you in identifying potentially unsafe conditions on these products. Each machine, as it was designed and built, had required safety items installed to protect users and service personnel from injury. This guide addresses only those items. However, good judgment should be used to identify potential safety hazards due to attachment of non-IBM features or options not covered by this inspection guide.

If any unsafe conditions are present, you must determine how serious the apparent hazard could be and whether you can continue without first correcting the problem.

Consider these conditions and the safety hazards they present:

- Electrical hazards, especially primary power (primary voltage on the frame can cause serious or fatal electrical shock).
- Explosive hazards, such as a damaged CRT face or bulging capacitor
- Mechanical hazards, such as loose or missing hardware

The guide consists of a series of steps presented in a checklist. Begin the checks with the power off, and the power cord disconnected.

Checklist:

1. Check exterior covers for damage (loose, broken, or sharp edges).
2. Power-off the computer. Disconnect the power cord.
3. Check the power cord for:
 - a. A third-wire ground connector in good condition. Use a meter to measure third-wire ground continuity for 0.1 ohm or less between the external ground pin and frame ground.
 - b. The power cord should be the appropriate type as specified in the parts listings.
 - c. Insulation must not be frayed or worn.
4. Remove the cover.
5. Check for any obvious non-IBM alterations. Use good judgment as to the safety of any non-IBM alterations.
6. Check inside the unit for any obvious unsafe conditions, such as metal filings, contamination, water or other liquids, or signs of fire or smoke damage.
7. Check for worn, frayed, or pinched cables.
8. Check that the power-supply cover fasteners (screws or rivets) have not been removed or tampered with.

Handling Electrostatic Discharge-Sensitive Devices

Any computer part containing transistors or integrated circuits (ICs) should be considered sensitive to electrostatic discharge (ESD). ESD damage can occur when there is a difference in charge between objects. Protect against ESD damage by equalizing the charge so that the machine, the part, the work mat, and the person handling the part are all at the same charge.

Notes:

1. Use product-specific ESD procedures when they exceed the requirements noted here.
2. Make sure that the ESD protective devices you use have been certified (ISO 9000) as fully effective.

When handling ESD-sensitive parts:

- Keep the parts in protective packages until they are inserted into the product.
- Avoid contact with other people.
- Wear a grounded wrist strap against your skin to eliminate static on your body.
- Prevent the part from touching your clothing. Most clothing is insulative and retains a charge even when you are wearing a wrist strap.
- Use the black side of a grounded work mat to provide a static-free work surface. The mat is especially useful when handling ESD-sensitive devices.
- Select a grounding system, such as those listed below, to provide protection that meets the specific service requirement.

Note: The use of a grounding system is desirable but not required to protect against ESD damage.

- Attach the ESD ground clip to any frame ground, ground braid, or green-wire ground.
- Use an ESD common ground or reference point when working on a double-insulated or battery-operated system. You can use coax or connector-outside shells on these systems.
- Use the round ground-prong of the AC plug on AC-operated computers.

Grounding Requirements

Electrical grounding of the computer is required for operator safety and correct system function. Proper grounding of the electrical outlet can be verified by a certified electrician.

Battery Notice

CAUTION

Pour éviter tout risque d'explosion, remplacez la pile selon les instructions du fabricant qui en définit les équivalences. Ne cherchez pas à la démonter ou à la recharger. Ne l'exposez ni au feu, ni à l'eau. Ne la mettez pas en court-circuit. Pour le recyclage ou la mise au rebut des piles usagées, conformez-vous à la réglementation en vigueur.

Die Batterie kann bei unsachgemäßem Austauschen explodieren. Eine verbrauchte Batterie nur durch eine gleichwertige, vom Hersteller empfohlene Batterie ersetzen. Die Batterie nicht zerlegen, wiederaufladen oder kurzschließen. Die Batterie vor Feuer und Nässe schützen. Bei der Entsorgung der aufladbaren Batterie die örtlichen Richtlinien für Sondermüll sowie die allgemeinen Sicherheitsbestimmungen beachten.

Se la batteria è sostituita in modo non corretto potrebbe esserci pericolo di esplosione. Si raccomanda di sostituirla con una batteria dello stesso tipo o equivalente. Non smontarla, ricaricarla, gettarla nell'acqua o nel fuoco, o cortocircuitarla. Smaltire la batteria secondo la normativa in vigore (DPR 915/82, successive disposizioni e disposizioni locali).

Hay peligro de explosión si la batería se sustituye incorrectamente. No la desmonte, recargue, eche al fuego o al agua, ni la cortocircuite. Deseche la batería tal y como disponga la normativa local.

Danger of explosion if battery is incorrectly replaced. Replace only with the same or equivalent type recommended by the manufacturer's instructions. Do not disassemble it, recharge it, throw it into fire or water, or short-circuit it. Dispose of the battery as required by local ordinances or regulations.

Software/Hardware Mismatch Problems

If a failure appears to be the result of a defective FRU, but the diagnostic tests run error-free, there might be a software and hardware mismatch. These problems might be intermittent, and they are usually difficult to diagnose.

If you are experiencing this type of problem, and the operating system is of the "direct driver" variety, which bypasses the BIOS interface, such as:

- AIX
- Netware
- SCO XENIX
- Some "windowing" interfaces
- Other Unix-based software

the most-likely cause of the problem is a mismatch between the software and the hardware.

Applications that use the Multiprotocol Adapter/A, magnetic tape drives, and some SCSI devices such as CD-ROM, require direct software drivers. There is no BIOS interface for these devices in IBM PC products.

The following information is provided to help you resolve these problems:

Software Can Be Sensitive to the Hardware

Direct-driver software is sensitive to variations in hardware design. The resulting incompatibilities are usually addressed with a revision (sometimes referred to as a patch), to the direct-driver software. Make certain the software is current and that all known revisions are installed. The IBM on-line bulletin board (sometimes referred to as PCPROD), and other software tools sources, such as Novell Netware, should be referenced by the software support personnel for any revisions provided by the appropriate software vendor.

The most-likely cause of these types of problems, when direct-driver software is involved, is the failure to obtain the latest revisions from the software vendor.

Software Installation

It is very important to follow the vendor's installation procedures. The software should not be migrated from another system, unless the installation instructions indicate that migration is supported (especially from a different model in the product line).

Important

Migrating adapters from slower systems to faster systems might cause problems. This is due to device-specific, system-specific, or time-dependent software code, that controls these devices.

Adapter and Software Compatibility

Hardware adapters for some operating systems must be approved by the software vendor to be compatible with that software. The approval is specific to the system, adapter E.C. level, and the software version. Contact the software vendor to confirm that system and adapter configuration is supported by their software level. The compatibility support is especially important for, (but not limited to), all LAN adapters and RIPL applications.

Software Failures After a Hardware Change

After the initial installation, any changes in the hardware configuration (addition or changes of adapters or features), might result in computer failures and require the reinstallation of the operating system or the software revisions.

Specific hardware configuration changes (such as memory address, interrupt level, or programmable option select), might result in a computer failure if the software has unique operating requirements.

Laser Compliance Statement

Some IBM Personal Computer models are equipped from the factory with a CD-ROM drive. CD-ROM drives are also sold separately as options. The CD-ROM drive is a laser product. The CD-ROM drive is certified in the U.S. to conform to the requirements of the Department of Health and Human Services 21 Code of Federal Regulations (DHHS 21 CFR) Subchapter J for Class 1 laser products. Elsewhere, the drive is certified to conform to the requirements of the International Electrotechnical Commission (IEC) 825 and CENELEC EN 60 825 for Class 1 laser products.

When a CD-ROM drive is installed, note the following.

CAUTION:

Use of controls or adjustments or performance of procedures other than those specified herein might result in hazardous radiation exposure.

Opening the CD-ROM drive could result in exposure to hazardous laser radiation. There are no serviceable parts inside the CD-ROM drive. **Do not open.**

Some CD-ROM drives contain an embedded Class 3A or Class 3B laser diode. Note the following.

DANGER

Laser radiation when open. Do not stare into the beam, do not view directly with optical instruments, and avoid direct exposure to the beam.

Problem Determination Tips

Due to the variety of hardware and software combinations that can be encountered, use the following information to assist you in problem determination. If possible, have this information available when requesting assistance from Service Support and Engineering functions.

- Machine type and model
- Processor or hard disk upgrades
- Failure symptom
 - Do diagnostics fail?
 - What, when, where, single, or multiple systems?
 - Is the failure repeatable?
 - Has this configuration ever worked?
 - If it has been working, what changes were made prior to it failing?
 - Is this the original reported failure?
- Reference/Diagnostics Diskette Version
 - Type and version level
- Hardware configuration
 - Print (print screen) configuration currently in use
 - BIOS level
- Operating system software
 - Type and version level

Important

To eliminate confusion, identical systems are considered *identical* only if they:

1. Are the exact machine type and models
2. Have the same BIOS level
3. Have the same adapters/attachments in the same locations
4. Have the same address jumpers/terminators/cabling
5. Have the same software versions and levels
6. Have the same Reference/Diagnostics Diskette (version)
7. Have the same configuration options set in the system
8. Have the same setup for the operation system control files

Comparing the configuration and software set-up between “working and non-working” systems will often lead to problem resolution.

Phone Numbers, U.S. and Canada

Note

EMEA customers should contact their Dealer or IBM Service organization.

Before you place a call to the Support Center, refer to "Problem Determination Tips" on page 191.

Authorized Dealers or Servicers

Number	Information
919-517-0001	Bulletin Board Service - PC Company
800-528-7705	Bulletin Board Service - TSS Only
800-937-3737	IBM Business Partner Education
800-426-2472	IBM Customer Engineer Technical Support
800-IBM-DEAL	IBM Dealer Support Center
800-342-6672	IBM Direct Desktop Software Sales
303-924-4015	IBM Part Number ID and Look Up
800-426-7763	IBM PC HelpCenter
800-237-5511	IBM Software Defect Support (CSDs)
800-327-5711	IBM Software Ordering (Publications)
800-426-1484	IBM Supplies Technical Hotline
800-388-7080	IBM Warranty Parts Claims Center

U.S. Customers and Helpware Subscribers

Number	Information
919-517-0001	Bulletin Board Service - PC Company
800-426-8322	Customer Education Business Unit
800-999-0052	Customized Operational Services
800-237-4824	EduQuest (Educational Computers)
800-964-8523	End User HelpDesk Support
800-742-2493	IBM Anti-Virus Services
800-447-4700	IBM Authorized Dealer Referrals
800-426-2468	IBM Dealer Referral
800-426-3333	IBM Information Referral Service
800-IBM-SERV	IBM Service
800-772-2227	IBM PC HelpCenter and HelpDesk
800-426-7282	IBM Technical Manuals
800-426-9402 (Ext. 150)	Multimedia Information Center
800-241-1620	Multimedia HelpCenter
800-342-6672	OS/2 Information Line
800-237-5511	OS/2 Support Services
800-284-5933	Prodigy
914-962-0310	Prodigy User Questions
800-547-1283	Technical Coordinator Program
	SystemXtra for Personal Systems
	LAN Automated Distribution/2
	OS/2 Bulletin Board
	OS/2 Application Assistance Center
800-551-2832	Technical Solutions Magazine

IBM Canada Customer and Servicer Support

Number	Information
800-661-PSMT 905-316-5556	Business Partner Marketing Support Business Partner Marketing Support - Toronto
514-938-6048	Business Partner Marketing Support - French
800-465-6600	Customer Relations
905-316-6666	Customer Relations - Toronto
800-465-6666	Customer Service Dispatch
800-263-2769	Customer Service Parts
800-465-2222	Customer Support Center (ISC)
416-443-5701	Customer Service Repair Center
800-465-7999	HelpClub Registration
800-465-7999	IBM Direct
905-513-3367	IBM Certification Administrator
905-316-2683	IBM Certification Coordinator Mail to: 50 Acadia Drive Markham, Ontario L3R 0B3
800-465-3299	IBM HelpFax
905-316-3299	IBM HelpFax - Toronto
800-565-3344	IBM HelpPC
800-268-3100	IBM Information Network Support
800-268-3100	IBM Information Network Support - Toronto
800-387-8343	IBM PC Service Partners
800-663-7662	Lexmark Product Information
800-263-2769	Parts Orders, Exchange or Emergency
416-443-5808 (Fax)	Parts Regular Orders, Exchange
416-443-5755	Parts Orders, Inquiries
514-938-3022	PC Co Bulletin Board - Montreal
905-316-4255	PC Co Bulletin Board - Toronto
604-664-6464	PC Co Bulletin Board - Vancouver
204-934-2735	PC Co Bulletin Board - Winnipeg
800-661-7768	PS Marketing Support (PSMT)
800-465-1234	Publications Ordering
905-316-4148	Service Management Support
905-316-4100 (Fax)	Service Management Support
905-316-4150	Service Manager
905-316-4100 (Fax)	Service Manager
905-316-4872	Service Quality Programs
905-316-4100 (Fax)	Service Quality Programs
800-661-2131	Skill Dynamics (Education)
800-565-3344	PS/1 Warranty Customer Helpline
800-387-8483	PS/1 Warranty Service (DOAs)
416-443-5835 (Fax)	Warranty Claim Fulfillment
905-316-2445	Warranty Claim Reimbursement
905-316-3515 (Fax)	Warranty Claim Reimbursement
416-443-5778	Warranty Claim Parts Inquiry
800-505-1855	Warranty Provider Support Hotline
800-267-7472	Warranty Service, ThinkPad

Notices

References in this publication to IBM products, programs, or services do not imply that IBM intends to make these available in all countries in which IBM operates. Any reference to an IBM product, program, or service is not intended to state or imply that only that IBM product, program, or service may be used. Subject to IBM's valid intellectual property or other legally protectable rights, any functionally equivalent product, program, or service may be used instead of the IBM product, program, or service. The evaluation and verification of operation in conjunction with other products, except those expressly designated by IBM, are the responsibility of the user.

Trademarks

The following terms are trademarks of the IBM Corporation in the United States or other countries:

AIX	Business Partner
EduQuest	HelpCenter
HelpClub	HelpFax
HelpWare	IBM
NetFinity	OS/2
Personal System/2	Predictive Failure Analysis
PS/1	PS/2
PS/ValuePoint	Skill Dynamics
SystemView	SystemXtra
ThinkPad	

The following terms are trademarks of other companies:

ADD	Applications Design and Development, Inc.
ARCnet	Datapoint Corporation
IPX	Novell, Inc.
Lexmark	Lexmark International, Inc.
NET	NCR Corporation
NetWare	Novell, Inc.
Novell	Novell, Inc.
Open Server	The Santa Cruz Operation, Inc.
Pentium	Intel Corporation
QAPlus/PRO	DiagSoft, Inc.
SCO	The Santa Cruz Operation, Inc.
SCSISelect	Adaptec, Inc.
Solaris	Sun Microsystems, Inc.
Sun	Sun Microsystems, Inc.
SunSoft	Sun Microsystems, Inc.
TME 10	Tivoli Systems Inc.
UnixWare	The Santa Cruz Operation, Inc.
Windows NT	Microsoft Corporation
XENIX	Microsoft Corporation

Microsoft and Windows, are trademarks or registered trademarks of Microsoft Corporation.

UNIX is a registered trademark in the United States and other countries licensed exclusively through X/Open Company Limited.



Part Number: 84H3050

Printed in U.S.A.

S84H-3050-00

