

# Intel® Desktop Board DX58S0 Technical Product Specification

*October 2008*

*Order Number: E51290-001US*

The Intel® Desktop Board DX58S0 may contain design defects or errors known as errata that may cause the product to deviate from published specifications. Current characterized errata are documented in the Intel Desktop Board DX58S0 Specification Update.

# Revision History

---

Revision	Revision History	Date
-001	First release of the Intel® Desktop Board DX58SO Technical Product Specification	October 2008

This product specification applies to only the standard Intel® Desktop Board DX58SO with BIOS identifier SOX5810J.86A.

Changes to this specification will be published in the Intel Desktop Board DX58SO Specification Update before being incorporated into a revision of this document.

INFORMATION IN THIS DOCUMENT IS PROVIDED IN CONNECTION WITH INTEL® PRODUCTS. NO LICENSE, EXPRESS OR IMPLIED, BY ESTOPPEL OR OTHERWISE, TO ANY INTELLECTUAL PROPERTY RIGHTS IS GRANTED BY THIS DOCUMENT. EXCEPT AS PROVIDED IN INTEL'S TERMS AND CONDITIONS OF SALE FOR SUCH PRODUCTS, INTEL ASSUMES NO LIABILITY WHATSOEVER, AND INTEL DISCLAIMS ANY EXPRESS OR IMPLIED WARRANTY, RELATING TO SALE AND/OR USE OF INTEL PRODUCTS INCLUDING LIABILITY OR WARRANTIES RELATING TO FITNESS FOR A PARTICULAR PURPOSE, MERCHANTABILITY, OR INFRINGEMENT OF ANY PATENT, COPYRIGHT OR OTHER INTELLECTUAL PROPERTY RIGHT. UNLESS OTHERWISE AGREED IN WRITING BY INTEL, THE INTEL PRODUCTS ARE NOT DESIGNED NOR INTENDED FOR ANY APPLICATION IN WHICH THE FAILURE OF THE INTEL PRODUCT COULD CREATE A SITUATION WHERE PERSONAL INJURY OR DEATH MAY OCCUR.

All Intel® desktop boards are evaluated as Information Technology Equipment (I.T.E.) for use in personal computers (PC) for installation in homes, offices, schools, computer rooms, and similar locations. The suitability of this product for other PC or embedded non-PC applications or other environments, such as medical, industrial, alarm systems, test equipment, etc. may not be supported without further evaluation by Intel.

Intel Corporation may have patents or pending patent applications, trademarks, copyrights, or other intellectual property rights that relate to the presented subject matter. The furnishing of documents and other materials and information does not provide any license, express or implied, by estoppel or otherwise, to any such patents, trademarks, copyrights, or other intellectual property rights.

Intel may make changes to specifications and product descriptions at any time, without notice.

Designers must not rely on the absence or characteristics of any features or instructions marked "reserved" or "undefined." Intel reserves these for future definition and shall have no responsibility whatsoever for conflicts or incompatibilities arising from future changes to them.

Intel desktop boards may contain design defects or errors known as errata, which may cause the product to deviate from published specifications. Current characterized errata are available on request.

Contact your local Intel sales office or your distributor to obtain the latest specifications before placing your product order.

Copies of documents which have an ordering number and are referenced in this document, or other Intel literature, may be obtained from:

Intel Corporation  
P.O. Box 5937  
Denver, CO 80217-9808

or call in North America 1-800-548-4725, Europe 44-0-1793-431-155, France 44-0-1793-421-777, Germany 44-0-1793-421-333, other Countries 708-296-9333.

Intel, Pentium, and Celeron are registered trademarks of Intel Corporation or its subsidiaries in the United States and other countries.

\* Other names and brands may be claimed as the property of others.

Copyright © 2008, Intel Corporation. All rights reserved.

# Preface

---

This Technical Product Specification (TPS) specifies the board layout, components, connectors, power and environmental requirements, and the BIOS for the Intel® Desktop Board DX58SO.

## Intended Audience

The TPS is intended to provide detailed, technical information about the Intel Desktop Board DX58SO and its components to the vendors, system integrators, and other engineers and technicians who need this level of information. It is specifically *not* intended for general audiences.

## What This Document Contains

Chapter	Description
1	A description of the hardware used on the Intel Desktop Board DX58SO
2	A map of the resources of the Intel Desktop Board
3	The features supported by the BIOS Setup program
4	A description of the BIOS error messages, beep codes, and POST codes
5	Regulatory compliance and battery disposal information

## Typographical Conventions

This section contains information about the conventions used in this specification. Not all of these symbols and abbreviations appear in all specifications of this type.

## Notes, Cautions, and Warnings



### NOTE

*Notes call attention to important information.*



### INTEGRATOR'S NOTES

*Integrator's notes are used to call attention to information that may be useful to system integrators.*



### CAUTION

*Cautions are included to help you avoid damaging hardware or losing data.*

## **Other Common Notation**

#	Used after a signal name to identify an active-low signal (such as USBP0#)
GB	Gigabyte (1,073,741,824 bytes)
GB/sec	Gigabytes per second
Gbits/sec	Gigabits per second
KB	Kilobyte (1024 bytes)
Kbit	Kilobit (1024 bits)
kbits/sec	1000 bits per second
MB	Megabyte (1,048,576 bytes)
MB/sec	Megabytes per second
Mbit	Megabit (1,048,576 bits)
Mbits/sec	Megabits per second
xxh	An address or data value ending with a lowercase h indicates a hexadecimal value.
x.x V	Volts. Voltages are DC unless otherwise specified.
*	This symbol is used to indicate third-party brands and names that are the property of their respective owners.

# Contents

---

<b>1</b>	<b>Product Description .....</b>	<b>9</b>
1.1	Overview.....	9
1.1.1	Feature Summary .....	9
1.1.2	Board Layout.....	11
1.1.3	Block Diagram .....	13
1.2	Legacy Considerations.....	14
1.3	Online Support.....	14
1.4	Processor .....	14
1.5	System Memory .....	15
1.5.1	Memory Configurations .....	16
1.6	Intel® X58 Chipset.....	18
1.6.1	USB .....	18
1.6.2	Serial ATA Interfaces .....	19
1.7	Discrete eSATA Controller.....	20
1.7.1	External Serial ATA Support.....	20
1.8	Real-Time Clock Subsystem .....	20
1.9	Legacy I/O Controller.....	21
1.9.1	Consumer Infrared (CIR).....	21
1.10	Audio Subsystem.....	22
1.10.1	Audio Subsystem Software .....	22
1.10.2	Audio Connectors and Headers .....	22
1.10.3	8-Channel (7.1) Audio Subsystem.....	23
1.11	LAN Subsystem.....	24
1.11.1	Intel® 82567LM Gigabit Ethernet Controller.....	24
1.11.2	LAN Subsystem Software.....	25
1.11.3	RJ-45 LAN Connector with Integrated LEDs .....	25
1.12	Hardware Management Subsystem .....	26
1.12.1	Hardware Monitoring and Fan Control.....	26
1.12.2	Fan Monitoring.....	26
1.12.3	Chassis Intrusion and Detection.....	26
1.12.4	Thermal Monitoring .....	27
1.13	Power Management .....	28
1.13.1	ACPI.....	28
1.13.2	Hardware Support .....	32
1.14	Onboard Power Button .....	36
1.14.1	ENERGY STAR* .....	37
<b>2</b>	<b>Technical Reference .....</b>	<b>39</b>
2.1	Memory Resources .....	39
2.1.1	Addressable Memory.....	39
2.1.2	Memory Map.....	41
2.2	Connectors and Headers.....	41
2.2.1	Back Panel Connectors .....	42

2.2.2	Component-side Connectors and Headers .....	43
2.3	Jumper Block .....	53
2.4	Mechanical Considerations .....	55
2.4.1	Form Factor.....	55
2.5	Electrical Considerations.....	56
2.5.1	Power Supply Considerations .....	56
2.5.2	Fan Header Current Capability.....	57
2.5.3	Add-in Board Considerations .....	57
2.6	Thermal Considerations.....	57
2.7	Reliability .....	60
2.8	Environmental .....	60
<b>3</b>	<b>Overview of BIOS Features .....</b>	<b>61</b>
3.1	Introduction .....	61
3.2	BIOS Flash Memory Organization .....	62
3.3	Resource Configuration .....	62
3.3.1	PCI Autoconfiguration .....	62
3.4	System Management BIOS (SMBIOS).....	63
3.5	Legacy USB Support .....	63
3.6	BIOS Updates .....	64
3.6.1	Language Support.....	64
3.6.2	Custom Splash Screen .....	65
3.7	BIOS Recovery.....	65
3.8	Boot Options.....	66
3.8.1	CD-ROM Boot .....	66
3.8.2	Network Boot.....	66
3.8.3	Booting Without Attached Devices.....	66
3.8.4	Changing the Default Boot Device During POST .....	66
3.9	Adjusting Boot Speed.....	67
3.9.1	Peripheral Selection and Configuration.....	67
3.9.2	BIOS Boot Optimizations .....	67
3.10	BIOS Security Features .....	68
3.11	BIOS Performance Features .....	69
<b>4</b>	<b>Error Messages and Beep Codes .....</b>	<b>71</b>
4.1	Speaker .....	71
4.2	BIOS Beep Codes .....	71
4.3	BIOS Error Messages .....	71
4.4	Port 80h POST Codes .....	72
<b>5</b>	<b>Regulatory Compliance and Battery Disposal Information ..</b>	<b>77</b>
5.1	Regulatory Compliance.....	77
5.1.1	Safety Standards.....	77
5.1.2	European Union Declaration of Conformity Statement.....	78
5.1.3	Product Ecology Statements.....	79
5.1.4	EMC Regulations .....	83
5.1.5	Product Certification Markings (Board Level).....	84
5.2	Battery Disposal Information.....	85

## Figures

Figure 1. Major Board Components.....	11
Figure 2. Block Diagram.....	13
Figure 3. Memory Channel and DIMM Configuration .....	17
Figure 4. Back Panel Audio Connector Options.....	23
Figure 5. LAN Connector LED Locations.....	25
Figure 6. Thermal Sensors and Fan Headers .....	27
Figure 7. Locations of Indicator LEDs .....	35
Figure 8. Location of the Onboard Power Button .....	36
Figure 9. Detailed System Memory Address Map.....	40
Figure 10. Back Panel Connectors.....	42
Figure 11. Component-side Connectors and Headers.....	43
Figure 12. Connection Diagram for Front Panel Header.....	50
Figure 13. Connection Diagram for Front Panel USB Headers.....	52
Figure 14. Connection Diagram for IEEE 1394a Header.....	52
Figure 15. Location of the Jumper Block .....	53
Figure 16. Board Dimensions .....	55
Figure 17. Localized High Temperature Zones .....	58

## Tables

Table 1. Feature Summary.....	9
Table 2. Components Shown in Figure 1.....	12
Table 3. Supported Memory Configurations.....	16
Table 4. LAN Connector LED States .....	25
Table 5. Effects of Pressing the Power Switch.....	29
Table 6. Power States and Targeted System Power.....	30
Table 7. Wake-up Devices and Events.....	31
Table 8. System Memory Map.....	41
Table 9. Component-side Connectors and Headers Shown in Figure 11 .....	44
Table 10. HD Audio Link Header.....	45
Table 11. Front Panel Audio Header.....	45
Table 12. Serial ATA Connectors .....	45
Table 13. Chassis Intrusion Header .....	46
Table 14. Front and Rear Chassis (3-Pin) Fan Headers.....	46
Table 15. Processor and Rear Chassis 2 (4-Pin) Fan Headers.....	46
Table 16. Auxiliary Front Panel Power/Sleep LED Header .....	47
Table 17. Processor Core Power Connector .....	48
Table 18. Main Power Connector .....	49
Table 19. Auxiliary PCI Express Graphics Power Connector.....	49
Table 20. Front Panel Header.....	50
Table 21. States for a One-Color Power LED .....	51
Table 22. States for a Two-Color Power LED .....	51
Table 23. BIOS Setup Configuration Jumper Settings .....	54
Table 24. Recommended Power Supply Current Values.....	56

## Intel Desktop Board DX58SO Technical Product Specification

Table 25. Fan Header Current Capability .....	57
Table 26. Thermal Considerations for Components.....	59
Table 27. Environmental Specifications .....	60
Table 28. BIOS Setup Program Menu Bar .....	62
Table 29. BIOS Setup Program Function Keys .....	62
Table 30. Acceptable Drives/Media Types for BIOS Recovery .....	65
Table 31. Boot Device Menu Options.....	66
Table 32. Supervisor and User Password Functions .....	68
Table 33. Beep Codes.....	71
Table 34. BIOS Error Messages .....	71
Table 35. Port 80h POST Code Ranges .....	72
Table 36. Port 80h POST Codes.....	73
Table 37. Typical Port 80h POST Sequence .....	76
Table 38. Safety Standards .....	77
Table 39. Lead-Free Board Markings .....	82
Table 40. EMC Regulations .....	83
Table 41. Product Certification Markings.....	84



# 1 Product Description

---

## 1.1 Overview

### 1.1.1 Feature Summary

Table 1 summarizes the major features of the board.

**Table 1. Feature Summary**

<b>Form Factor</b>	ATX (12.00 inches by 9.60 inches [304.80 millimeters by 243.84 millimeters])
<b>Processor</b>	<ul style="list-style-type: none"><li>• Intel® Core™ i7 Processor in an LGA1366 socket</li></ul>
<b>Memory</b>	<ul style="list-style-type: none"><li>• Four 240-pin DDR3 SDRAM Dual Inline Memory Module (DIMM) sockets</li><li>• Support for DDR3 1333 MHz, DDR3 1066 MHz, and DDR3 800 MHz DIMMs</li><li>• Support for up to 16 GB of system memory</li><li>• Support for non-ECC memory</li><li>• XMP version 1.2</li></ul>
<b>Chipset</b>	Intel® X58 Chipset, consisting of: <ul style="list-style-type: none"><li>• Intel® X58 I/O Hub (IOH)</li><li>• Intel® 82801IJR I/O Controller Hub (ICH10R)</li></ul>
<b>Audio</b>	Intel® High Definition Audio subsystem using the Realtek* ALC889 audio codec.
<b>Legacy I/O Control</b>	Winbond legacy I/O controller for Consumer Infrared (CIR)
<b>Peripheral Interfaces</b>	<ul style="list-style-type: none"><li>• Twelve USB 2.0 ports</li><li>• Six internal Serial ATA interfaces with RAID support</li><li>• Two External Serial ATA (eSATA) ports on back panel with RAID support</li><li>• Two IEEE 1394a ports (one on back panel, one front-panel header)</li></ul>
<b>BIOS</b>	<ul style="list-style-type: none"><li>• Intel® BIOS resident in the SPI Flash device</li><li>• Support for Advanced Configuration and Power Interface (ACPI), Plug and Play, and SMBIOS</li></ul>
<b>Instantly Available PC Technology</b>	<ul style="list-style-type: none"><li>• Support for PCI Local Bus Specification Revision 2.2</li><li>• Support for PCI Express* Revision 2.0</li><li>• Suspend to RAM support</li><li>• Wake on PCI, front panel, CIR, and USB ports</li></ul>
<b>LAN Support</b>	Gigabit (10/100/1000 Mbps/sec) LAN subsystem using the Intel® 82567LM Gigabit Ethernet Controller

continued

**Table 1. Feature Summary** (continued)

<b>Expansion Capabilities</b>	<ul style="list-style-type: none"><li>• One PCI* Conventional bus add-in card connector (SMBus routed to PCI Conventional bus add-in card connector)</li><li>• Two PCI Express 2.0 x16 bus add-in card connectors</li><li>• One PCI Express 2.0 x4 bus add-in card connector</li><li>• Two PCI Express 1.1 x1 bus add-in card connectors</li></ul>
<b>Hardware Monitor Subsystem</b>	<ul style="list-style-type: none"><li>• Hardware monitoring and fan control ASIC</li><li>• Voltage sense to detect out of range power supply voltages</li><li>• Thermal sense to detect out of range thermal values</li><li>• Four fan headers using PWM control</li><li>• Three fan sense inputs used to monitor fan activity</li><li>• Fan speed control using voltage control (3-pin fan headers front and rear)</li><li>• Support for Product Environmental Control Interface (PECI)</li></ul>

### 1.1.2 Board Layout

Figure 1 shows the location of the major components on Intel Desktop Board DX58SO.

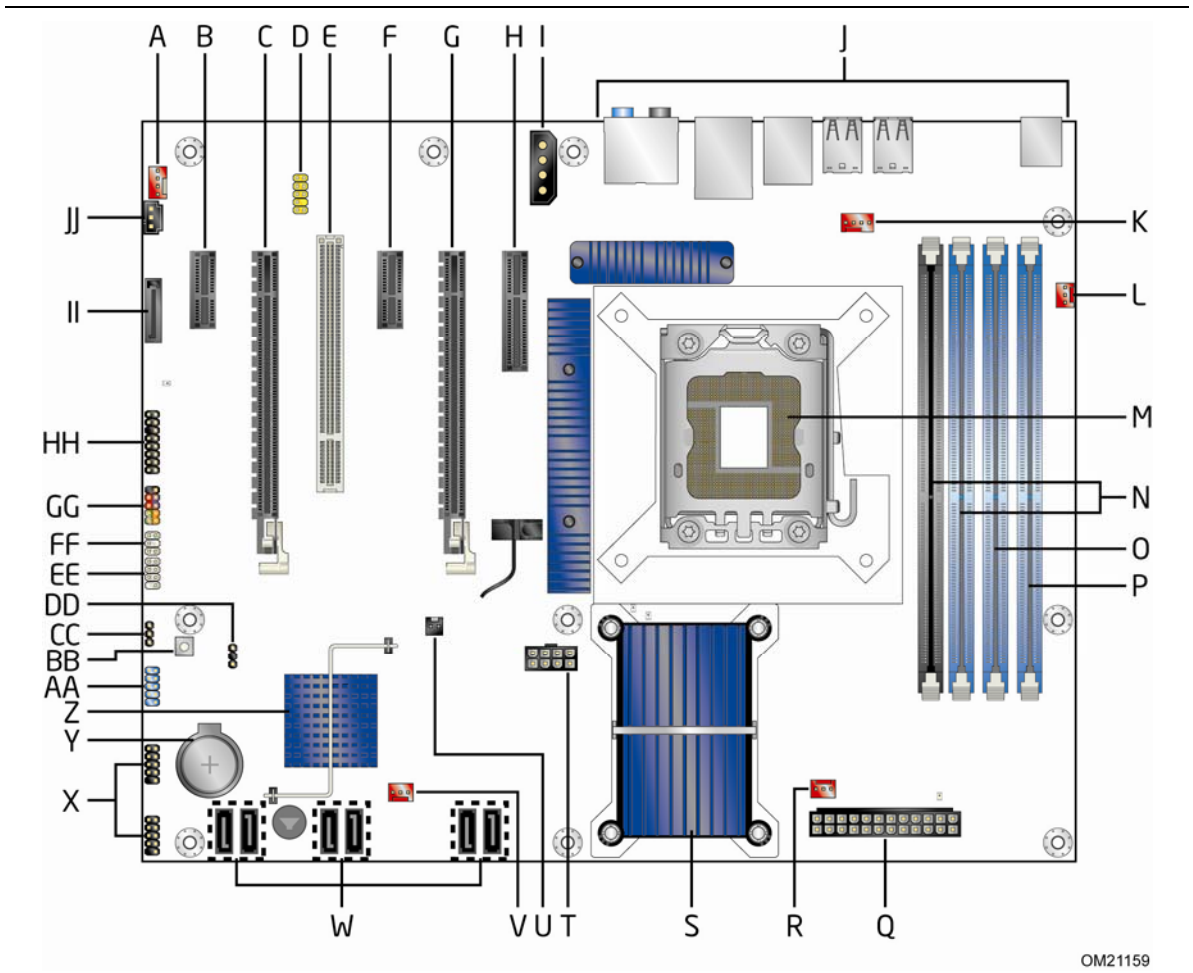

OM21159

**Figure 1. Major Board Components**

Table 2 lists the components identified in Figure 1.

**Table 2. Components Shown in Figure 1**

<b>Item/callout from Figure 1</b>	<b>Description</b>
A	Auxiliary fan
B	PCI Express x1 connector
C	PCI Express x16 bus add-in card connector (Secondary)
D	Front panel audio header
E	PCI Conventional bus add-in card connector
F	PCI Express x1 bus add-in card connector
G	PCI Express x16 bus add-in card connector (Primary)
H	PCI Express x4 bus add-in card connector
I	Auxiliary PCI Express graphics power connector
J	Back panel connectors
K	Processor fan header
L	Rear fan header
M	LGA1366 processor socket
N	DIMM Channel A sockets [2]
O	DIMM Channel B socket
P	DIMM Channel C socket
Q	Main power connector
R	I/O Hub fan header
S	Intel 82X58 IO Hub (IOH)
T	Processor core power connector (2 X 4)
U	Chassis intrusion header
V	Front chassis fan header
W	Serial ATA connectors [6]
X	Front panel USB headers [2]
Y	Battery
Z	Intel 82801IJR I/O Controller Hub (ICH10R)
AA	IEEE 1394a front panel header
BB	Onboard power button
CC	BIOS Setup configuration jumper block
DD	Auxiliary front panel power LED header
EE	Front panel CIR receiver (input) header
FF	Back panel CIR emitter (output) header
GG	Front panel header
HH	High Definition Audio Link header
II	SATA power connector
JJ	S/PDIF connector

### 1.1.3 Block Diagram

Figure 2 is a block diagram of the major functional areas of the board.

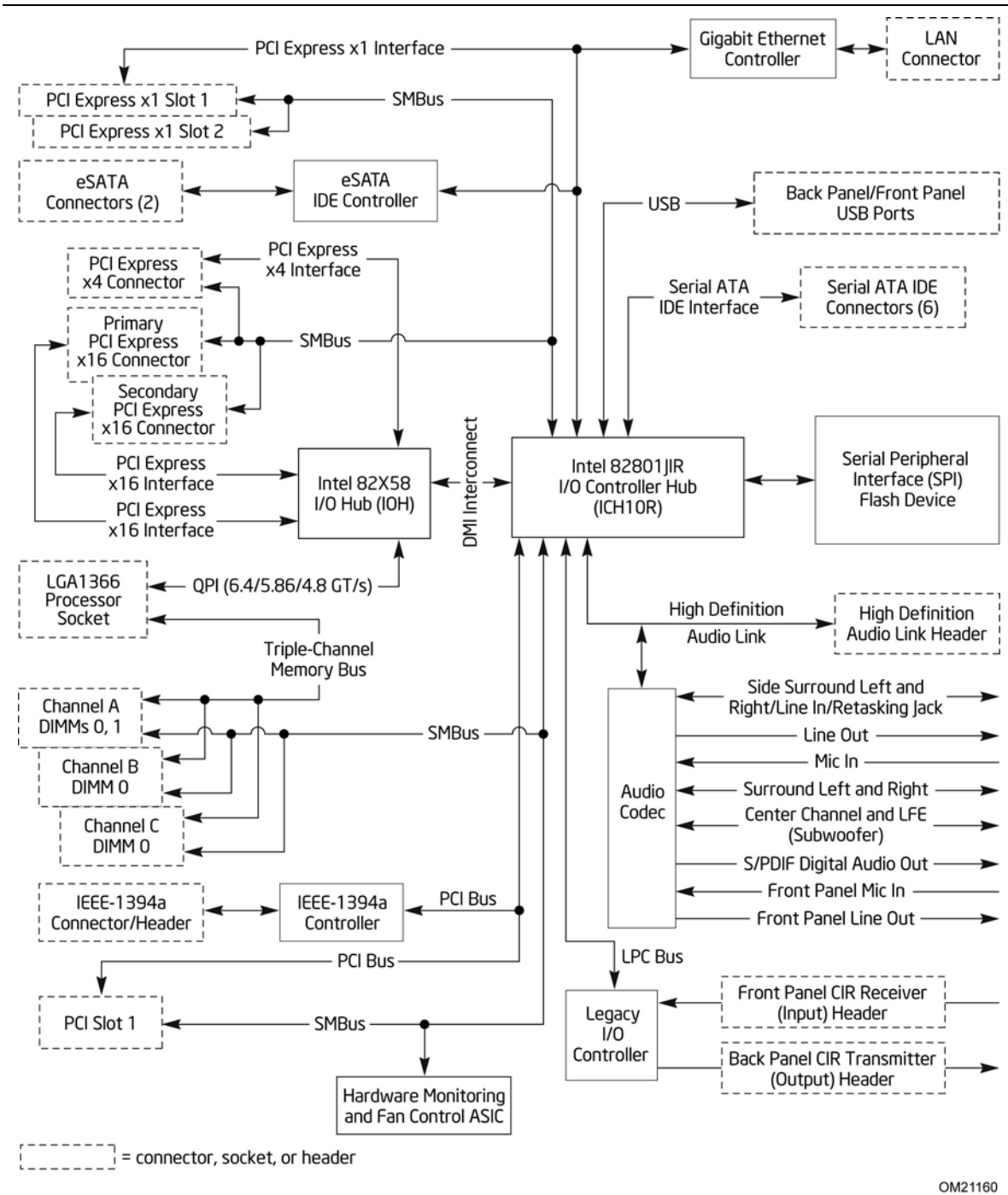

OM21160

Figure 2. Block Diagram

## 1.2 Legacy Considerations

This board differs from other Intel Desktop Board products, with specific changes including (but not limited to) the following:

- No parallel port
- No floppy drive connector
- No serial port
- No PS/2 connectors

## 1.3 Online Support

To find information about...	Visit this World Wide Web site:
Intel® Desktop Board DX58SO	<a href="http://www.intel.com/products/motherboard/DX58SO/index.htm">http://www.intel.com/products/motherboard/DX58SO/index.htm</a>
Desktop Board Support	<a href="http://support.intel.com/support/motherboards/desktop/DX58SO">http://support.intel.com/support/motherboards/desktop/DX58SO</a>
Available configurations for the Intel Desktop Board DX58SO	<a href="http://www.intel.com/products/motherboard/DX58SO/index.htm">http://www.intel.com/products/motherboard/DX58SO/index.htm</a>
Supported processors	<a href="http://www.intel.com/go/findcpu">http://www.intel.com/go/findcpu</a>
Chipset information	<a href="http://www.intel.com/products/desktop/chipsets/index.htm">http://www.intel.com/products/desktop/chipsets/index.htm</a>
BIOS and driver updates	<a href="http://downloadcenter.intel.com/">http://downloadcenter.intel.com/</a>

## 1.4 Processor

The board is designed to support the following processor:

- Intel Core i7 Processor in an LGA1366 socket

Other processors may be supported in the future. This board is designed to support processors with a maximum wattage of 130 W. The processor listed above is only supported when falling within the wattage requirements of the Intel Desktop Board DX58SO. See the Intel web site listed below for the most up-to-date list of supported processors.

For information about...	Refer to:
Supported processors	<a href="http://processormatch.intel.com">http://processormatch.intel.com</a>



### CAUTION

*Use only the processors listed on the web site above. Use of unsupported processors can damage the board, the processor, and the power supply.*



### INTEGRATOR'S NOTE

*This board has specific requirements for providing power to the processor. Refer to Section 2.5.1 on page 56 for information on power supply requirements for this board.*

## 1.5 System Memory

The board has four DIMM sockets and supports the following memory features:

- 1.5 V DDR3 SDRAM DIMMs
- Three independent memory channels with interleaved mode support
- Unbuffered, single-sided or double-sided DIMMs with the following restriction:  
Double-sided DIMMs with x16 organization are not supported.
- 16 GB maximum total system memory. Refer to Section 2.1.1 on page 39 for information on the total amount of addressable memory.
- Minimum total system memory: 1 GB
- Non-ECC DIMMs
- Serial Presence Detect
- DDR3 1333 MHz, DDR3 1066 MHz, and DDR3 800 MHz SDRAM DIMMs
- XMP version 1.2 performance profile support for memory speeds above 1333 MHz



### NOTE

*To be fully compliant with all applicable DDR SDRAM memory specifications, the board should be populated with DIMMs that support the Serial Presence Detect (SPD) data structure. This allows the BIOS to read the SPD data and program the chipset to accurately configure memory settings for optimum performance. If non-SPD memory is installed, the BIOS will attempt to correctly configure the memory settings, but performance and reliability may be impacted or the DIMMs may not function under the determined frequency.*

Table 3 lists the supported DIMM configurations.

**Table 3. Supported Memory Configurations**

<b>DIMM Capacity</b>	<b>Configuration</b> <small>(Note 1)</small>	<b>SDRAM Density</b>	<b>SDRAM Organization</b> <b>Front-side/Back-side</b>	<b>Number of SDRAM Devices</b> <small>(Note 2)</small>
1024 MB	SS	1 Gbit	128 M x 8/empty	8 [9]
2048 MB	DS	1 Gbit	128 M x 8/128 M x 8	16 [18]

Notes:

1. In the second column, "DS" refers to double-sided memory modules (containing two rows of SDRAM) and "SS" refers to single-sided memory modules (containing one row of SDRAM).
2. In the fifth column, the number in brackets specifies the number of SDRAM devices on an ECC DIMM.

<b>For information about...</b>	<b>Refer to:</b>
Tested Memory	<a href="http://support.intel.com/support/motherboards/desktop/sb/CS-025414.htm">http://support.intel.com/support/motherboards/desktop/sb/CS-025414.htm</a>
XMP Tested Memory	<a href="http://www.intel.com/personal/gaming/extremememory.htm">http://www.intel.com/personal/gaming/extremememory.htm</a>

### 1.5.1 Memory Configurations

The Intel Core i7 Processor supports the following types of memory organization:

- **Tri/Dual channel (Interleaved) mode.** This mode offers the highest throughput for real world applications. Interleaving reduces overall memory latency by accessing the DIMM memory sequentially. Data is spread amongst the memory modules in an alternating pattern.
  - Three independent memory channels give two possible modes of interleaving:
    - Tri-channel mode is enabled when identical matched memory modules are installed in each of the three memory channels (blue connectors).
    - Dual channel mode is enabled when two of the blue memory connectors are populated with matched DIMMs.
- **Single channel (Asymmetric) mode.** This mode is equivalent to single channel bandwidth operation for real world applications. This mode is used when only a single DIMM is installed or the installed memory modules are not matched. Technology and device width can vary from one channel to the other.

<b>For information about...</b>	<b>Refer to:</b>
Memory Configuration Examples	<a href="http://www.intel.com/support/motherboards/desktop/sb/cs-011965.htm">http://www.intel.com/support/motherboards/desktop/sb/cs-011965.htm</a>

Figure 3 illustrates the memory channel and DIMM configuration.



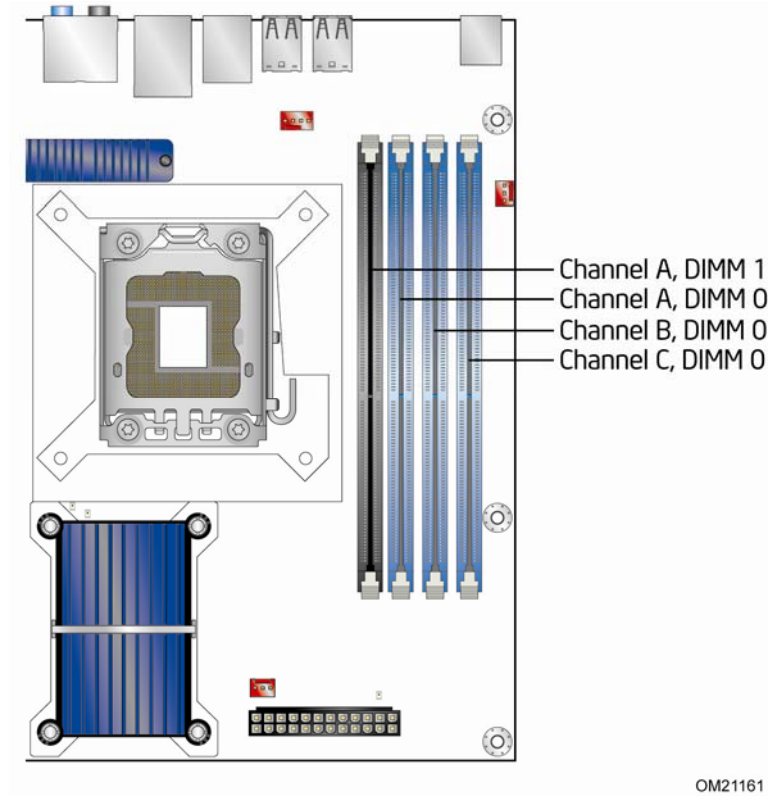

OM21161

Figure 3. Memory Channel and DIMM Configuration

## 1.6 Intel® X58 Chipset

The Intel X58 chipset consists of the following devices:

- Intel 82X58 IOH with Direct Media Interface (DMI) interconnect
- Intel 82801IJR I/O Controller Hub (ICH10R)

The IOH component provides interfaces to the processor and the PCI Express graphics connectors. The ICH10R is a centralized controller for the board's I/O paths.

<b>For information about</b>	<b>Refer to</b>
The Intel X58 chipset	<a href="http://www.intel.com/products/desktop/chipsets/index.htm">http://www.intel.com/products/desktop/chipsets/index.htm</a>
Resources used by the chipset	Chapter 2

### 1.6.1 USB

The board supports up to twelve USB 2.0 ports, supports UHCI and EHCI, and uses UHCI- and EHCI-compatible drivers.

The ICH10R provides the USB controller for all ports. The port arrangement is as follows:

- Eight ports are implemented with dual stacked back panel connectors adjacent to the audio connectors
- Four ports are routed to two separate front panel USB headers

<b>For information about</b>	<b>Refer to</b>
The location of the USB connectors on the back panel	Figure 10, page 42
The location of the front panel USB headers	Figure 11, page 43

## 1.6.2 Serial ATA Interfaces

The board provides six Serial ATA (SATA) connectors, which support one device per connector. The board also provides two red-colored external Serial ATA (eSATA) connectors on the back panel.

### 1.6.2.1 Serial ATA Support

The board's Serial ATA controller offers six independent Serial ATA ports with a theoretical maximum transfer rate of 3 Gbits/sec per port. One device can be installed on each port for a maximum of six Serial ATA devices. A point-to-point interface is used for host to device connections, unlike Parallel ATA IDE which supports a master/slave configuration and two devices per channel.

For compatibility, the underlying Serial ATA functionality is transparent to the operating system. The Serial ATA controller can operate in both legacy and native modes. In legacy mode, standard IDE I/O and IRQ resources are assigned (IRQ 14 and 15). In Native mode, standard PCI Conventional bus resource steering is used. Native mode is the preferred mode for configurations using the Windows\* XP and Windows Vista\* operating systems.



#### NOTE

*Many Serial ATA drives use new low-voltage power connectors and require adapters or power supplies equipped with low-voltage power connectors.*

For more information, see: <http://www.serialata.org/>.

For information about	Refer to
The location of the Serial ATA connectors	Figure 11, page 43

### 1.6.2.2 Serial ATA RAID

The board supports the following RAID (Redundant Array of Independent Drives) levels via the ICH10R:

- **RAID 0** - data striping
- **RAID 1** - data mirroring
- **RAID 0+1 (or RAID 10)** - data striping and mirroring
- **RAID 5** - distributed parity



#### NOTE

*In order to use supported RAID features, you must first enable RAID in the BIOS. Also, during Microsoft Windows XP installation, you must press F6 to install the RAID drivers. See your Microsoft Windows XP documentation for more information about installing drivers during installation.*

## 1.7 Discrete eSATA Controller

The board provides a discrete Marvell\* controller to support two eSATA connectors on the back panel.

### 1.7.1 External Serial ATA Support

The red Serial ATA connectors on the back panel can be used for an external SATA drive. They can also be used for port replication, which allows the aggregation of multiple hard drives on each of the eSATA ports. Figure 10 on page 42 shows the location of the External Serial ATA-compatible SATA ports on the back panel.

The Marvell 88SE621 controller uses the PCI Express bus for data transfer with a theoretical maximum transfer rate of 3 Gbits/sec per port. These connectors are in addition to the six SATA connectors of the ICH10R SATA interface.

The discrete SATA interface supports the following RAID levels:

- RAID 0
- RAID 1



#### NOTE

*The Marvell 88SE621 controller supports single drive non-RAID configurations as well as RAID configurations. For RAID configurations, you must install the RAID drivers by pressing F6 during operating system installation. See your operating system installation documentation for more information about installing drivers during the installation process.*

For information about	Refer to
The location of the discrete SATA RAID connectors	Figure 11, page 43

## 1.8 Real-Time Clock Subsystem

A coin-cell battery (CR2032) powers the real-time clock and CMOS memory. When the computer is not plugged into a wall socket, the battery has an estimated life of three years. When the computer is plugged in, the standby current from the power supply extends the life of the battery. The clock is accurate to  $\pm 13$  minutes/year at 25 °C with 3.3 VSB applied.



#### NOTE

*If the battery and AC power fail Date and Time values will be reset and the user will be notified during POST.*

When the voltage drops below a certain level, the BIOS Setup program settings stored in CMOS RAM (for example, the date and time) might not be accurate. Replace the battery with an equivalent one. Figure 1 on page 11 shows the location of the battery.

## 1.9 Legacy I/O Controller

The I/O controller provides the following features:

- Consumer Infrared (CIR) headers
- Serial IRQ interface compatible with serialized IRQ support for PCI systems
- Intelligent power management, including a programmable wake-up event interface
- PCI power management support

The BIOS Setup program provides configuration options for the I/O controller.

### 1.9.1 Consumer Infrared (CIR)

The Consumer Infrared (CIR) feature is designed to comply with Microsoft Consumer Infrared usage models. Microsoft Windows Vista is the supported operating system

The CIR feature is made up of two separate pieces: the receiving (receiver) header, and the output (emitter) header. The receiving header consists of a filtered translated infrared input compliant with Microsoft CIR specifications, and also a "learning" infrared input. This learning input is simply a high pass input which the computer can use to "learn" to speak the infrared communication language of other user remotes. The emitter header consists of two output ports which the PC can use to emulate "learned" infrared commands in order to control external electronic hardware.

Customers are required to buy or create their own interface modules to plug into Intel Desktop Boards for this feature to work.

## 1.10 Audio Subsystem

The board supports the Intel High Definition Audio subsystem based on the Realtek ALC889 audio codec. The audio subsystem supports the following features:

- Advanced jack sense for the back panel audio jacks that enables the audio codec to recognize the device that is connected to an audio port. The back panel audio jacks are capable of retasking according to user's definition, or can be automatically switched depending on the recognized device type.
- Stereo input and output for all back panel jacks
- Line out and Mic in functions for front panel audio jacks
- A signal-to-noise (S/N) ratio of 90 dB

### 1.10.1 Audio Subsystem Software

Audio software and drivers are available from Intel's World Wide Web site.

For information about	Refer to
Obtaining audio software and drivers	Section 1.3, page 14

### 1.10.2 Audio Connectors and Headers

The board contains audio connectors and headers on both the back panel and the component side of the board. The component-side audio headers include the following:

- Front panel audio (a 2 x 5-pin header that provides mic in and line out signals for front panel audio connectors)
- High Definition (HD) Audio Link header (a 2 x 8-pin header for S/PDIF) used for HDMI Video cards
- S/PDIF audio connector (1 x 3-pin connector) can be used for HDMI Video cards that do not work with the HD Audio header
- S/PDIF output between the back panel Optical connector and the internal S/PDIF header can be selected in BIOS setup

For information about	Refer to
The locations of the front panel audio header, HD Audio Link header, and S/PDIF audio connector	Figure 11, page 43
The signal names of the front panel audio header	Table 11, page 45
The back panel audio connectors	Section 2.2.1, page 42

### 1.10.3 8-Channel (7.1) Audio Subsystem

The 8-channel (7.1) audio subsystem includes the following:

- Intel 82801IJR (ICH10R)
- Realtek ALC889 audio codec
- Microphone input that supports a single dynamic, condenser, or electret microphone

The back panel audio connectors are configurable through the audio device drivers. The available configurable audio ports are shown in Figure 4.

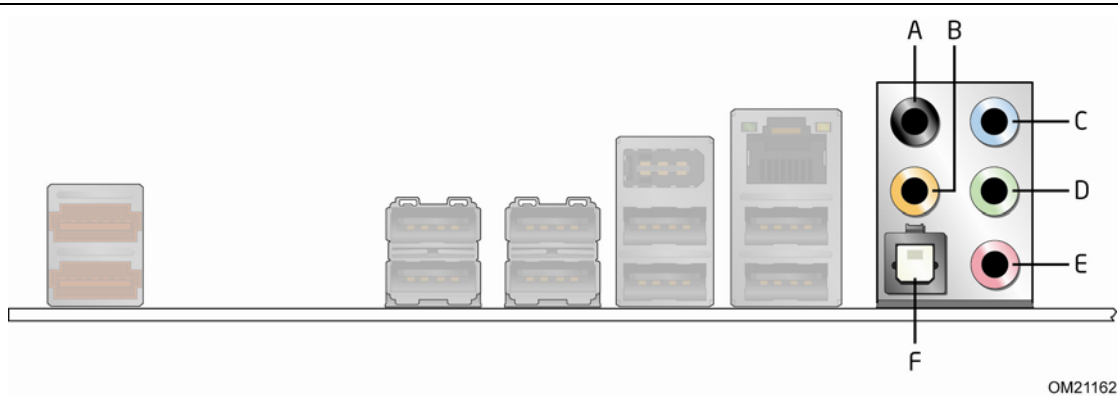

Item	Description
A	Surround left/right channel audio out/Retasking Jack
B	Center channel and LFE (subwoofer) audio out
C	Line in (Side Channel Surround) audio out/Retasking Jack
D	Line out/Headphone (Stereo)
E	Mic in
F	S/PDIF Digital Audio Out (Optical)

**Figure 4. Back Panel Audio Connector Options**

**For information about**

The back panel audio connectors

**Refer to**

Section 2.2.1, page 42

## 1.11 LAN Subsystem

The LAN subsystem consists of the following:

- Intel 82567LM Gigabit Ethernet Controller (10/100/1000 Mbits/sec)
- Intel 82801IJR (ICH10R)
- RJ-45 LAN connector with integrated status LEDs

Additional features of the LAN subsystem include:

- CSMA/CD protocol engine
- LAN connect interface between ICH10R and the LAN controller
- PCI Conventional bus power management
  - ACPI technology support
  - LAN wake capabilities
- LAN subsystem software

---

**For information about**

LAN software and drivers

**Refer to**

<http://downloadcenter.intel.com>

---

### 1.11.1 Intel® 82567LM Gigabit Ethernet Controller

The Intel 82567LM Gigabit Ethernet Controller supports the following features:

- PCI Express link
- 10/100/1000 IEEE 802.3 compliant
- Compliant to IEEE 802.3x flow control support
- 802.1p and 802.1q
- TCP, IP, and UDP checksum offload (for IPv4 and IPv6)
- Transmit TCP segmentation
- Full device driver compatibility
- PCI Express power management support



### 1.11.2 LAN Subsystem Software

LAN software and drivers are available from Intel’s World Wide Web site.

**For information about**

**Refer to**

Obtaining LAN software and drivers

<http://downloadcenter.intel.com>

### 1.11.3 RJ-45 LAN Connector with Integrated LEDs

Two LEDs are built into the RJ-45 LAN connector (shown in Figure 5 below).



Item	Description
A	Link LED (Green)
B	Data Rate LED (Green/Yellow)

**Figure 5. LAN Connector LED Locations**

Table 4 describes the LED states when the board is powered up and the LAN subsystem is operating.

**Table 4. LAN Connector LED States**

LED	LED Color	LED State	Condition
Link	Green	Off	LAN link is not established.
		On	LAN link is established.
		Blinking	LAN activity is occurring
Data Rate	Green/Yellow	Off	10 Mbits/sec data rate is selected.
		Green	100 Mbits/sec data rate is selected.
		Yellow	1000 Mbits/sec data rate is selected.

## 1.12 Hardware Management Subsystem

The hardware management features enable the board to be compatible with the Wired for Management (WfM) specification. The board has several hardware management features, including the following:

- Fan monitoring and control
- Thermal and voltage monitoring
- Chassis intrusion detection

### 1.12.1 Hardware Monitoring and Fan Control

The features of the hardware monitoring and fan control include:

- Fan speed control controllers and sensors provided by the Hardware Monitoring and Fan Control ASIC
- Thermal sensors in the processor, 82X58 IOH, and 82801IJR ICH10R
- Power supply monitoring of five voltages (+5 V, +12 V, +3.3 VSB, +1.1 V, and +VCCP) to detect levels above or below acceptable values
- Thermally monitored closed-loop fan control, for all three fans, that can adjust the fan speed or switch the fans on or off as needed

### 1.12.2 Fan Monitoring

Fan monitoring can be implemented using Intel® Desktop Control Center or third-party software.

<b>For information about</b>	<b>Refer to</b>
------------------------------	-----------------

The functions of the fan headers	Section 1.13.2.2, page 33
----------------------------------	---------------------------

### 1.12.3 Chassis Intrusion and Detection

The board supports a chassis security feature that detects if the chassis cover is removed. The security feature uses a mechanical switch on the chassis that attaches to the chassis intrusion header. When the chassis cover is removed, the mechanical switch is in the closed position.

<b>For information about</b>	<b>Refer to</b>
------------------------------	-----------------

The location of the chassis intrusion header	Figure 11, page 43
--	--------------------

### 1.12.4 Thermal Monitoring

Figure 6 shows the locations of the thermal sensors and fan headers.

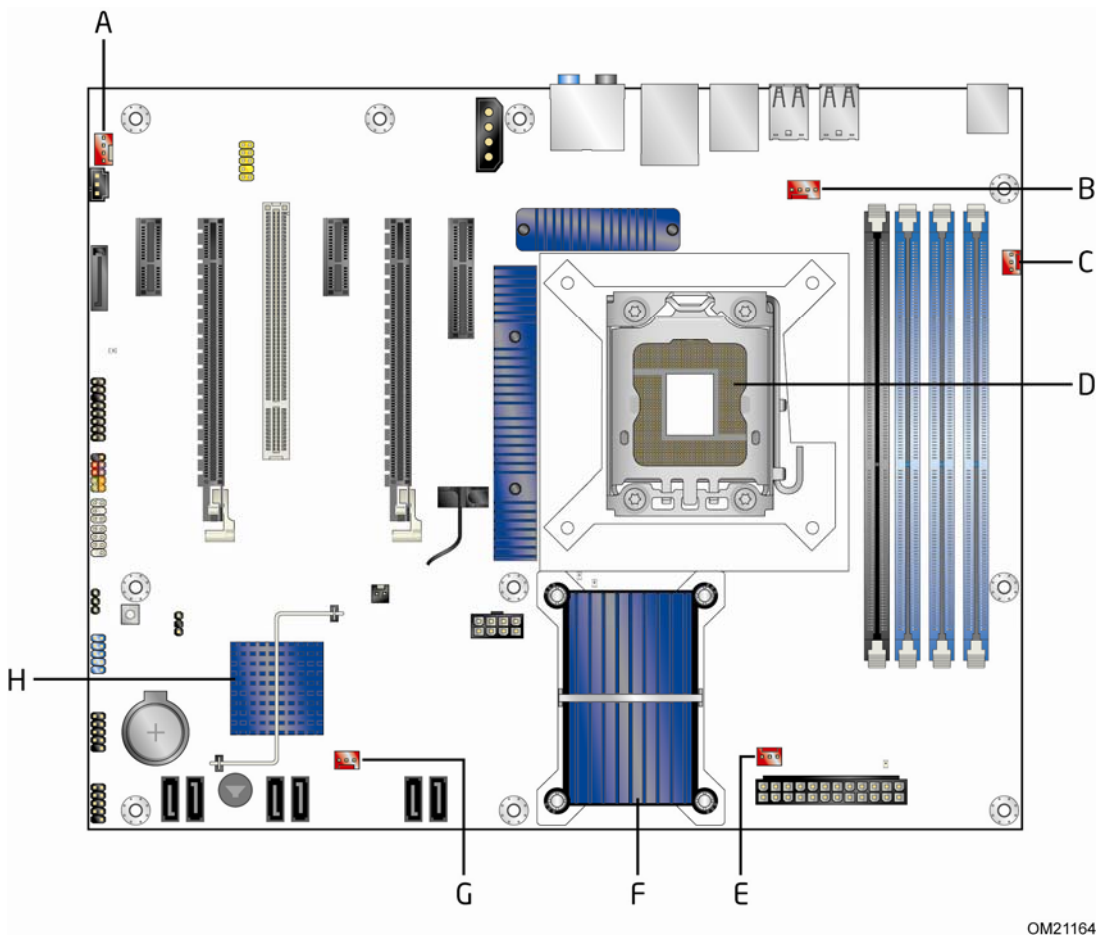

OM21164

Item	Description
A	Auxiliary rear chassis fan
B	Processor fan
C	Rear fan
D	Thermal diode, located on processor die
E	IOH fan
F	Thermal diode, located on the IOH die
G	Front chassis fan
H	Thermal diode, located on the ICH10R die

**Figure 6. Thermal Sensors and Fan Headers**

## 1.13 Power Management

Power management is implemented at several levels, including:

- Software support through Advanced Configuration and Power Interface (ACPI)
- Hardware support:
  - Power connector
  - Fan headers
  - LAN wake capabilities
  - Instantly Available PC technology
  - Wake from USB
  - Power Management Event signal (PME#) wake-up support
  - PCI Express WAKE# signal support

### 1.13.1 ACPI

ACPI gives the operating system direct control over the power management and Plug and Play functions of a computer. The use of ACPI with this board requires an operating system that provides full ACPI support. ACPI features include:

- Plug and Play (including bus and device enumeration)
- Power management control of individual devices, add-in boards (some add-in boards may require an ACPI-aware driver), video displays, and hard disk drives
- Methods for achieving less than 15-watt system operation in the power-on/standby sleeping state
- A Soft-off feature that enables the operating system to power-off the computer
- Support for multiple wake-up events (see Table 7 on page 31)
- Support for a front panel power and sleep mode switch

Table 5 lists the system states based on how long the power switch is pressed, depending on how ACPI is configured with an ACPI-aware operating system.

**Table 5. Effects of Pressing the Power Switch**

<b>If the system is in this state...</b>	<b>...and the power switch is pressed for</b>	<b>...the system enters this state</b>
Off (ACPI G2/G5 – Soft off)	Less than four seconds	Power-on (ACPI G0 – working state)
On (ACPI G0 – working state)	Less than four seconds	Soft-off/Standby (ACPI G1 – sleeping state)
On (ACPI G0 – working state)	More than six seconds	Fail safe power-off (ACPI G2/G5 – Soft off)
Sleep (ACPI G1 – sleeping state)	Less than four seconds	Wake-up (ACPI G0 – working state)
Sleep (ACPI G1 – sleeping state)	More than six seconds	Power-off (ACPI G2/G5 – Soft off)

### 1.13.1.1 System States and Power States

Under ACPI, the operating system directs all system and device power state transitions. The operating system puts devices in and out of low-power states based on user preferences and knowledge of how devices are being used by applications. Devices that are not being used can be turned off. The operating system uses information from applications and user settings to put the system as a whole into a low-power state.

Table 6 lists the power states supported by the board along with the associated system power targets. See the ACPI specification for a complete description of the various system and power states.

**Table 6. Power States and Targeted System Power**

<b>Global States</b>	<b>Sleeping States</b>	<b>Processor States</b>	<b>Device States</b>	<b>Targeted System Power</b> (Note 1)
G0 – working state	S0 – working	C0 – working	D0 – working state.	Full power > 30 W
G1 – sleeping state	S1 – Processor stopped	C1 – stop grant	D1, D2, D3 – device specification specific.	5 W < power < 52.5 W
G1 – sleeping state	S3 – Suspend to RAM. Context saved to RAM.	No power	D3 – no power except for wake-up logic.	Power < 5 W (Note 2)
G1 – sleeping state	S4 – Suspend to disk. Context saved to disk.	No power	D3 – no power except for wake-up logic.	Power < 5 W (Note 2)
G2/S5	S5 – Soft off. Context not saved. Cold boot is required.	No power	D3 – no power except for wake-up logic.	Power < 5 W (Note 2)
G3 – mechanical off AC power is disconnected from the computer.	No power to the system.	No power	D3 – no power for wake-up logic, except when provided by battery or external source.	No power to the system. Service can be performed safely.

Notes:

1. Total system power is dependent on the system configuration, including add-in boards and peripherals powered by the system chassis' power supply.
2. Dependent on the standby power consumption of wake-up devices used in the system.

### 1.13.1.2 Wake-up Devices and Events

Table 7 lists the devices or specific events that can wake the computer from specific states.

**Table 7. Wake-up Devices and Events**

These devices/events can wake up the computer...	...from this state
LAN	S1, S3, S4, S5 <sup>(Note 1)</sup>
PME# signal	S1, S3, S4, S5 <sup>(Note 1)</sup>
Power switch	S1, S3, S4, S5
RTC alarm	S1, S3, S4, S5
USB	S1, S3
WAKE#	S1, S3, S4, S5
Consumer IR	S1, S3 (S4 and S5) <sup>(Note 2)</sup>

Note 1: For LAN and PME# signal, S5 is disabled by default in the BIOS Setup program. Setting this option to Power On will enable a wake-up event from LAN in the S5 state.

Note 2: Wake from S4 and S5 is optional by the specification.



#### **NOTE**

*The use of these wake-up events from an ACPI state requires an operating system that provides full ACPI support. In addition, software, drivers, and peripherals must fully support ACPI wake events.*

## 1.13.2 Hardware Support



### CAUTION

*Ensure that the power supply provides adequate +5 V standby current if LAN wake capabilities and Instantly Available PC technology features are used. Failure to do so can damage the power supply. The total amount of standby current required depends on the wake devices supported and manufacturing options.*

The board provides several power management hardware features, including:

- Power connector
- Fan headers
- LAN wake capabilities
- Instantly Available PC technology
- Wake from USB
- PME# signal wake-up support
- WAKE# signal wake-up support
- Wake from Consumer IR

LAN wake capabilities and Instantly Available PC technology require power from the +5 V standby line.



### NOTE

*The use of Wake from USB from an ACPI state requires an operating system that provides full ACPI support.*

#### 1.13.2.1 Power Connector

ATX12V-compliant power supplies can turn off the system power through system control. When an ACPI-enabled system receives the correct command, the power supply removes all non-standby voltages.

When resuming from an AC power failure, the computer returns to the power state it was in before power was interrupted (on or off). The computer's response can be set using the Last Power State feature in the BIOS Setup program's Boot menu.

<b>For information about</b>	<b>Refer to</b>
The location of the main power connector	Figure 11, page 43
The signal names of the main power connector	Table 18, page 49



### 1.13.2.2 Fan Headers

The function/operation of the fan headers is as follows:

- The fans are on when the board is in the S0 or S1 state.
- The fans are off when the board is off or in the S3, S4, or S5 state.
- Each fan header is wired to a fan tachometer input of the hardware monitoring and fan control ASIC, except the fan header located at J7TH (item R on Figure 1, page 11)
- All fan headers support closed-loop fan control that can adjust the fan speed or switch the fan on or off as needed
- All fan headers have a +12 V DC connection
- 4-pin fan headers are controlled by Pulse Width Modulation
- 3-pin fan headers (front and rear) are modulated by voltage control

For information about	Refer to
The location of the fan headers	Figure 11, page 43
The location of the fan headers and sensors for thermal monitoring	Figure 6, page 27
The signal names of the fan headers	Section 0, page 42

### 1.13.2.3 LAN Wake Capabilities



#### CAUTION

*For LAN wake capabilities, the +5 V standby line for the power supply must be capable of providing adequate +5 V standby current. Failure to provide adequate standby current when implementing LAN wake capabilities can damage the power supply.*

LAN wake capabilities enable remote wake-up of the computer through a network. The LAN subsystem PCI bus network adapter monitors network traffic at the Media Independent Interface. Upon detecting a Magic Packet\* frame, the LAN subsystem asserts a wake-up signal that powers up the computer. Depending on the LAN implementation, the board supports LAN wake capabilities with ACPI in the following ways:

- The PCI Express WAKE# signal
- The PCI bus PME# signal for PCI 2.3 compliant LAN designs
  - By Ping
  - Magic Packet
- The onboard LAN subsystem
- Wake from CIR

### 1.13.2.4 Instantly Available PC Technology



#### **CAUTION**

*For Instantly Available PC technology, the +5 V standby line for the power supply must be capable of providing adequate +5 V standby current. Failure to provide adequate standby current when implementing Instantly Available PC technology can damage the power supply.*

Instantly Available PC technology enables the board to enter the ACPI S3 (Suspend-to-RAM) sleep-state. While in the S3 sleep-state, the computer will appear to be off (the power supply is off, and the front panel LED is amber if dual colored, or off if single colored.) When signaled by a wake-up device or event, the system quickly returns to its last known wake state. Table 7 on page 31 lists the devices and events that can wake the computer from the S3 state.

The board supports the *PCI Bus Power Management Interface Specification*. Add-in boards that also support this specification can participate in power management and can be used to wake the computer.

The use of Instantly Available PC technology requires operating system support and PCI 2.2 compliant add-in cards, PCI Express add-in cards, and drivers.

### 1.13.2.5 Wake from USB

USB bus activity wakes the computer from ACPI S1 or S3 states.



#### **NOTE**

*Wake from USB requires the use of a USB peripheral that supports Wake from USB.*

### 1.13.2.6 PME# Signal Wake-up Support

When the PME# signal on the PCI Conventional bus is asserted, the computer wakes from an ACPI S1, S3, S4, or S5 state (with Wake on PME enabled in the BIOS).

### 1.13.2.7 WAKE# Signal Wake-up Support

When the WAKE# signal on the PCI Express bus is asserted, the computer wakes from an ACPI S1, S3, S4, or S5 state.

### 1.13.2.8 +5 V Standby Power Indicator LED and Additional LEDs

The +5 V standby power indicator LED shows that power is still present even when the computer appears to be off. Figure 7 shows the location of the standby power indicator LED on the board.



#### CAUTION

*If AC power has been switched off and the standby power indicators are still lit, disconnect the power cord before installing or removing any devices connected to the board. Failure to do so could damage the board and any attached devices.*

In addition to the standby power indicator, the board contains two LEDs that indicate the following:

- The Processor LED indicates an elevated temperature on the processor that could effect performance
- The Voltage Regulator LED indicates an elevated temperature in the processor voltage regulator circuit that could effect performance

Figure 7 shows the location of these additional LEDs.

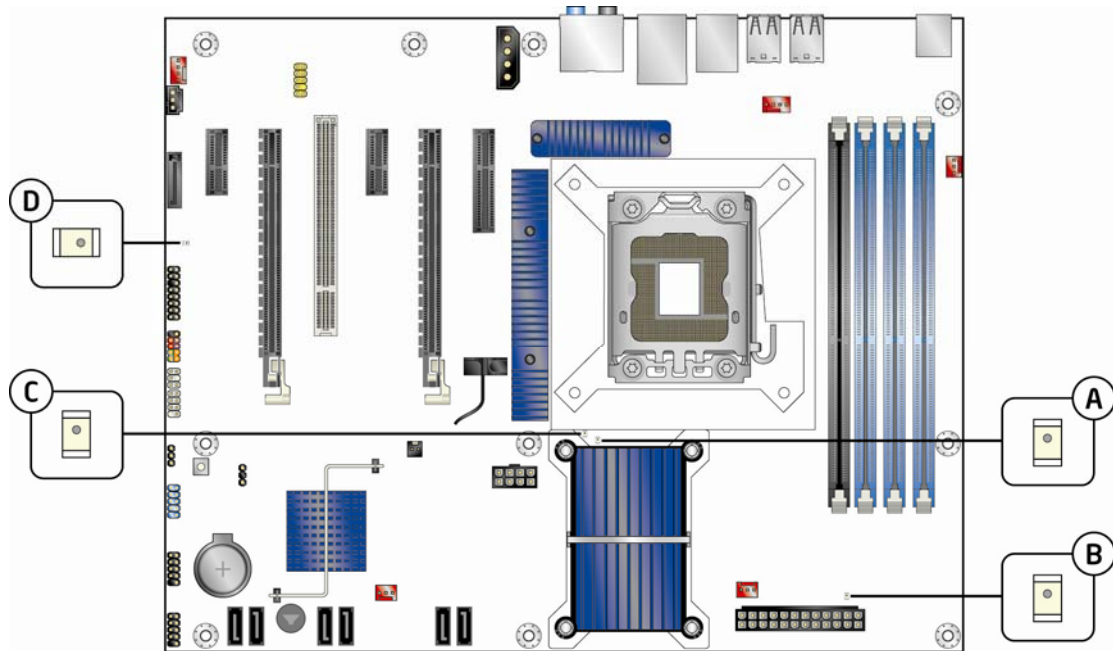

OM21165

Item	Description
A	Voltage Regulator LED (Red)
B	Standby power indicator LED (Green)
C	Processor LED (Red)
D	Hard drive activity LED (Green)

**Figure 7. Locations of Indicator LEDs**

## 1.14 Onboard Power Button

The board provides a power button that can be used to turn the computer on or off. This button is intended for use at integration facilities to remove standby power before making changes to the system configuration, or for testing purposes.

The power button on the front panel is recommended for all other instances of turning the computer on or off. To turn the computer off using the onboard power button, keep the button pressed down for three seconds. Figure 8 shows the location of the onboard power button.

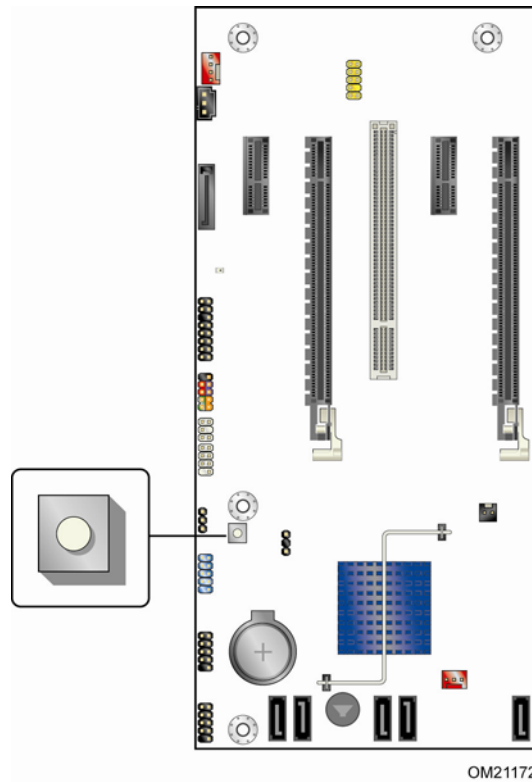

**Figure 8. Location of the Onboard Power Button**



### **CAUTION**

*Electrostatic discharge (ESD) can damage components. The onboard power button should be used only at an ESD workstation using an antistatic wrist strap and a conductive foam pad. If such a station is not available, some ESD protection can be provided by wearing an antistatic wrist strap and attaching it to a metal part of the computer chassis.*

### 1.14.1 ENERGY STAR\*

In 2007, the US Department of Energy and the US Environmental Protection Agency revised the ENERGY STAR\* requirements. Intel has worked directly with these two governmental agencies to define the new requirements. Currently this Intel Desktop Board meets the new Category C requirements when using the appropriate peripherals.

---

**For information about**

ENERGY STAR requirements and recommended configurations

**Refer to**

<http://www.intel.com/go/energystar>

---



## 2 Technical Reference

---

### 2.1 Memory Resources

#### 2.1.1 Addressable Memory

The board utilizes 16 GB of addressable system memory. Typically the address space that is allocated for PCI Conventional bus add-in cards, PCI Express configuration space, BIOS (SPI Flash device), and chipset overhead resides above the top of DRAM (total system memory). On a system that has 16 GB of system memory installed, it is not possible to use all of the installed memory due to system address space being allocated for other system critical functions. These functions include the following:

- BIOS/SPI Flash device (16 Mbit)
- Local APIC (19 MB)
- Direct Media Interface (40 MB)
- Front side bus interrupts (17 MB)
- PCI Express configuration space (256 MB)
- IOH base address registers PCI Express ports (up to 256 MB)
- Memory-mapped I/O that is dynamically allocated for PCI Conventional and PCI Express add-in cards (256 MB)

The board provides the capability to reclaim the physical memory overlapped by the memory mapped I/O logical address space. The board remaps physical memory from the top of usable DRAM boundary to the 4 GB boundary to an equivalent sized logical address range located just above the 4 GB boundary. Figure 9 shows a schematic of the system memory map. All installed system memory can be used when there is no overlap of system addresses.

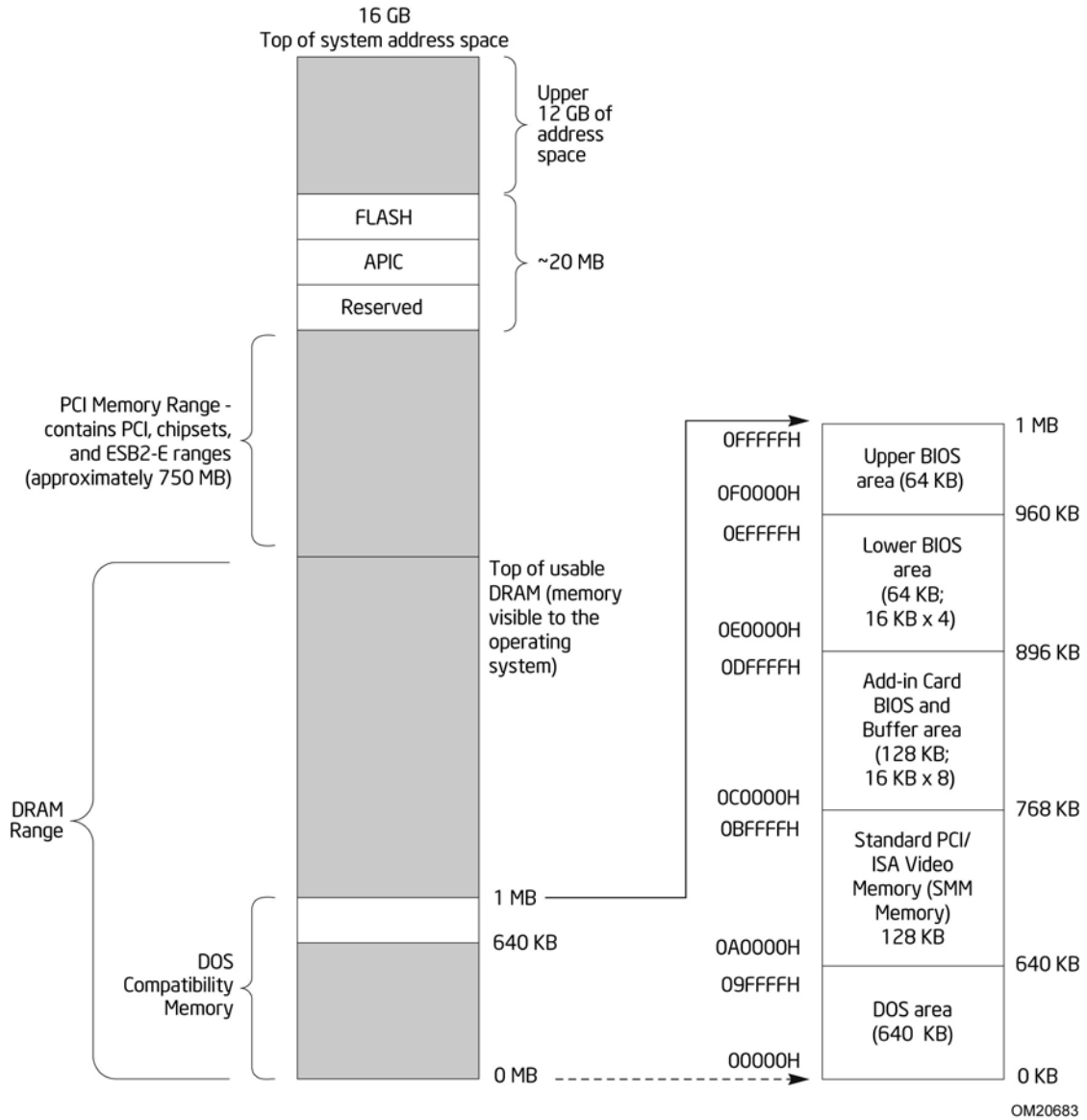

Figure 9. Detailed System Memory Address Map



## 2.1.2 Memory Map

Table 8 lists the system memory map.

**Table 8. System Memory Map**

Address Range (decimal)	Address Range (hex)	Size	Description
1024 K - 16777216 K	100000 - 3FFFFFFF	16382 MB	Extended memory
960 K - 1024 K	F0000 - FFFFF	64 KB	Runtime BIOS
896 K - 960 K	E0000 - EFFFF	64 KB	Reserved
800 K - 896 K	C8000 - DFFFF	96 KB	Potential available high DOS memory (open to the PCI Conventional bus). Dependent on video adapter used.
640 K - 800 K	A0000 - C7FFF	160 KB	Video memory and BIOS
639 K - 640 K	9FC00 - 9FFFF	1 KB	Extended BIOS data (movable by memory manager software)
512 K - 639 K	80000 - 9FBFF	127 KB	Extended conventional memory
0 K - 512 K	00000 - 7FFFF	512 KB	Conventional memory

## 2.2 Connectors and Headers



### CAUTION

*Only the following connectors and headers have overcurrent protection: back panel and front panel USB, as well as IEEE 1394a.*

*The other internal connectors and headers are not overcurrent protected and should connect only to devices inside the computer's chassis, such as fans and internal peripherals. Do not use these connectors or headers to power devices external to the computer's chassis. A fault in the load presented by the external devices could cause damage to the computer, the power cable, and the external devices themselves.*

*Furthermore, improper connection of USB or 1394 header single wire connectors may eventually overload the overcurrent protection and cause damage to the board.*

This section describes the board's connectors. The connectors can be divided into these groups:

- Back panel I/O connectors
- Component-side I/O connectors and headers (see page 43)

## 2.2.1 Back Panel Connectors

Figure 10 shows the location of the back panel connectors for the board.

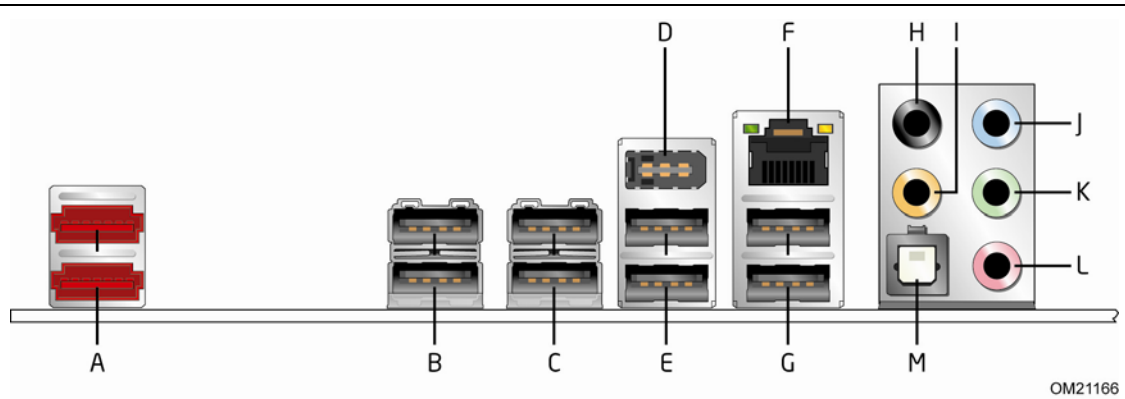

OM21166

Item	Description
A	eSATA ports
B	USB ports
C	USB ports
D	IEEE-1394a connector
E	USB ports
F	LAN
G	USB ports
H	Center channel and LFE (subwoofer) audio out/Retasking Jack G
I	Surround left/right channel audio out/Retasking Jack H
J	Audio line in/(Side Surround) audio out/Retasking Jack C
K	Front left/right channel audio out/Two channel audio line out/Retasking Jack D
L	Mic in
M	Digital audio out optical

**Figure 10. Back Panel Connectors**



### NOTE

*The back panel audio line out connector is designed to power headphones or amplified speakers only. Poor audio quality occurs if passive (non-amplified) speakers are connected to this output.*

### 2.2.2 Component-side Connectors and Headers

Figure 11 shows the locations of the component-side connectors and headers.

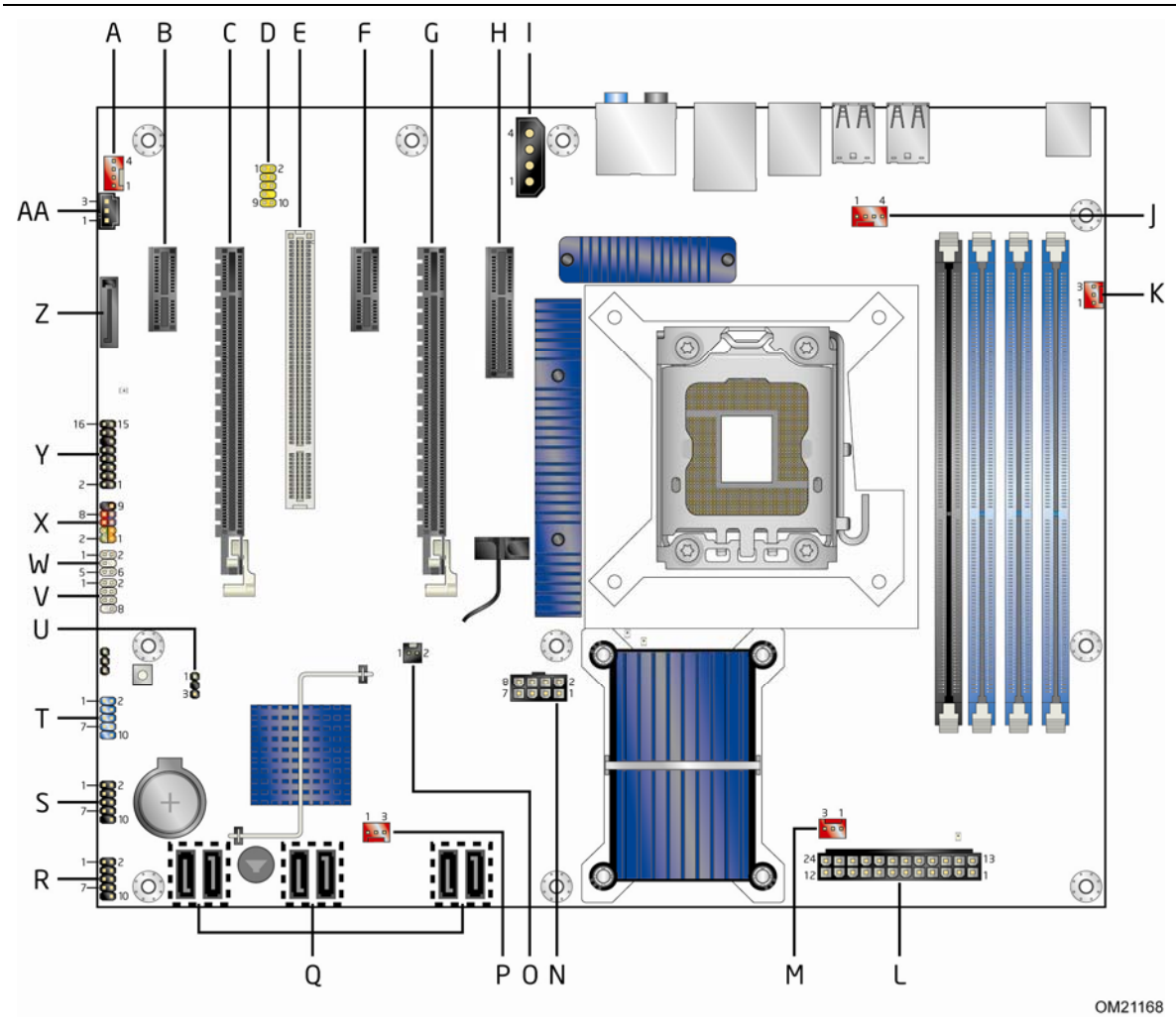

OM21168

**Figure 11. Component-side Connectors and Headers**

Table 9 lists the component-side connectors and headers identified in Figure 11.

**Table 9. Component-side Connectors and Headers Shown in Figure 11**

<b>Item/callout from Figure 11</b>	<b>Description</b>
A	Auxiliary fan header
B	PCI Express x1 connector
C	PCI Express x16 bus add-in card connector
D	Front panel audio header
E	PCI Conventional bus add-in card connector
F	PCI Express x1 bus add-in card connector
G	PCI Express x16 bus add-in card connector
H	PCI Express x4 bus add-in card connector
I	Auxiliary PCI Express graphics power connector
J	Processor fan header
K	Rear fan header
L	Main power connector
M	I/O Hub fan header
N	Processor core power connector (2 X 4)
O	Chassis intrusion header
P	Front chassis fan header
Q	Serial ATA connectors [6]
R	Front panel USB header
S	Front panel USB header
T	IEEE 1394a front panel header
U	Auxiliary front panel power LED header
V	Front panel CIR receiver (input) header
W	Back panel CIR emitter (output) header
X	Front panel header
Y	High Definition Audio Link header
Z	SATA connector
AA	S/PDIF connector

## 2.2.2.1 Signal Tables for the Connectors and Headers

**Table 10. HD Audio Link Header**

Pin	Signal Name	Pin	Signal Name
1	BCLK	2	Ground
3	RST#	4	3.3 VCC
5	SYNC	6	Ground
7	SDO	8	3.3 VCC
9	SDI0	10	+12 V
11	SDI1	12	Key (no pin)
13	Aud RSVD	14	3.3 V STBY
15	Aud RSVD	16	Ground

**Table 11. Front Panel Audio Header**

Pin	Signal Name	Pin	Signal Name
1	[Port 2] Left channel	2	Ground
3	[Port 2] Right channel	4	PRESENCE# (Dongle present)
5	[Port 1] Right channel	6	[Port 1] SENSE_RETURN
7	SENSE_SEND (Jack detection)	8	Key (no pin)
9	[Port 2] Left channel	10	[Port 2] SENSE_RETURN

**Table 12. Serial ATA Connectors**

Pin	Signal Name
1	Ground
2	TXP
3	TXN
4	Ground
5	RXN
6	RXP
7	Ground

**Table 13. Chassis Intrusion Header**

Pin	Signal Name
1	Intruder
2	Ground

**Table 14. Front and Rear Chassis (3-Pin) Fan Headers**

Pin	Signal Name
1	Control (Note)
2	+12 V
3	Tach

Note: These fan headers use voltage variance control for fan speed.

**Table 15. Processor and Rear Chassis 2 (4-Pin) Fan Headers**

Pin	Signal Name
1	Ground (Note)
2	+12 V
3	FAN_TACH
4	FAN_CONTROL

Note: These fan headers use Pulse Width Modulation control for fan speed.

**Table 20. Back Panel CIR Emitter (Output) Header**

Pin	Signal Name
1	Emitter out 1
2	Emitter out 2
3	Ground
4	Key (no pin)
5	Jack detect 1
6	Jack detect 2

**Table 21. Front Panel CIR Receiver (Input) Header**

Pin	Signal Name
1	Ground
2	LED
3	NC
4	Learn-in
5	5 V standby
6	VCC
7	Key (no pin)
8	CIR Input

### 2.2.2.2 Add-in Card Connectors

The board has the following add-in card connectors:

- PCI Express 2.0 x16: two PCI Express 2.0 x16 connectors supporting simultaneous transfer speeds up to 8 GB/sec of peak bandwidth per direction and up to 16 GB/sec concurrent bandwidth.
- PCI Express 2.0 x4: one PCI Express 2.0 x4 connector (implemented using a x4 physical connector capable of accepting a x16 card). The x4 interface supports simultaneous transfer speeds up to 250 MB/sec of peak bandwidth per direction and up to 5 GB/sec concurrent bandwidth.
- PCI Express 1.1 x1: two PCI Express 1.1 x1 connectors. The x1 interface supports simultaneous transfer speeds up to 250 MB/sec of peak bandwidth per direction and up to 2 GB/sec concurrent bandwidth.
- PCI Conventional (rev 2.3 compliant) bus: one PCI Conventional bus add-in card connector. The SMBus is routed to the PCI Conventional bus connector. PCI Conventional bus add-in cards with SMBus support can access sensor data and other information residing on the board.

Note the following considerations for the PCI Conventional bus connector:

- The PCI Conventional bus connector is bus master capable.
- SMBus signals are routed to the PCI Conventional bus connector. This enables PCI Conventional bus add-in boards with SMBus support to access sensor data on the board. The specific SMBus signals are as follows:
  - The SMBus clock line is connected to pin A40.
  - The SMBus data line is connected to pin A41.

### 2.2.2.3 Auxiliary Front Panel Power/Sleep LED Header

Pins 1 and 3 of this header duplicate the signals on pins 2 and 4 of the front panel header.

**Table 16. Auxiliary Front Panel Power/Sleep LED Header**

Pin	Signal Name	In/Out	Description
1	HDR_BLNK_GRN	Out	Front panel green LED
2	Not connected		
3	HDR_BLNK_YEL	Out	Front panel yellow LED

### 2.2.2.4 Power Supply Connectors

The board has the following power supply connectors:

- **Main power** – a 2 x 12 connector. This connector is compatible with 2 x 10 connectors previously used on Intel Desktop boards. The board supports the use of ATX12V power supplies with either 2 x 10 or 2 x 12 main power cables. When using a power supply with a 2 x 10 main power cable, attach that cable on the rightmost pins of the main power connector, leaving pins 11, 12, 23, and 24 unconnected.
- **Processor core power** – a 2 x 4 connector. This connector provides power directly to the processor voltage regulator and must always be used. Failure to do so will prevent the board from booting.
- **Auxiliary PCI Express graphics power** – a 1 x 4 connector. This connector provides the required additional power when using high power (75 W or greater) add-in cards in either or both the Secondary PCI Express x16 (electrical x8) and the PCI Express x16 (electrical x4) bus add-in card connectors. See Figure 1 for location.
- **“SATA style” power connector** – an additional power connector for supplemental power which can be used in addition to or in place of the Auxiliary PCI Express graphics power connector.



#### CAUTION

*If high power (75 W or greater) add-in cards are installed in either or both the Secondary PCI Express x16 and the PCI Express x4 bus add-in card connectors, the Auxiliary PCI Express graphics power connector must be used. Failure to do so may cause damage to the board and the add-in cards.*

**Table 17. Processor Core Power Connector**

Pin	Signal Name	Pin	Signal Name
1	Ground	2	+12 V
3	Ground	4	+12 V
5	Ground	6	+12 V
7	Ground	8	+12 V



**Table 18. Main Power Connector**

Pin	Signal Name	Pin	Signal Name
1	+3.3 V	13	+3.3 V
2	+3.3 V	14	-12 V
3	Ground	15	Ground
4	+5 V	16	PS-ON# (power supply remote on/off)
5	Ground	17	Ground
6	+5 V	18	Ground
7	Ground	19	Ground
8	PWRGD (Power Good)	20	No connect
9	+5 V (Standby)	21	+5 V
10	+12 V	22	+5 V
11	+12 V (Note)	23	+5 V (Note)
12	2 x 12 connector detect (Note)	24	Ground (Note)

Note: When using a 2 x 10 power supply cable, this pin will be unconnected.

**Table 19. Auxiliary PCI Express Graphics Power Connector**

Pin	Signal Name
1	+12 V
2	1 x 4 connector detect
3	Ground
4	+5 V

**For information about**

Power supply considerations

**Refer to**

Section 2.5.1 on page 56

### 2.2.2.5 Front Panel Header

This section describes the functions of the front panel header. Table 20 lists the signal names of the front panel header. Figure 12 is a connection diagram for the front panel header.

**Table 20. Front Panel Header**

Pin	Signal	In/Out	Description	Pin	Signal	In/Out	Description
Hard Drive Activity LED				Power LED			
1	HD_PWR	Out	Hard disk LED pull-up to +5 V	2	HDR_BLNK_GRN	Out	Front panel green LED
3	HDA#	Out	Hard disk active LED	4	HDR_BLNK_YEL	Out	Front panel yellow LED
Reset Switch				On/Off Switch			
5	Ground		Ground	6	FPBUT_IN	In	Power switch
7	FP_RESET#	In	Reset switch	8	Ground		Ground
Power				Not Connected			
9	+5 V		Power	10	N/C		Not connected

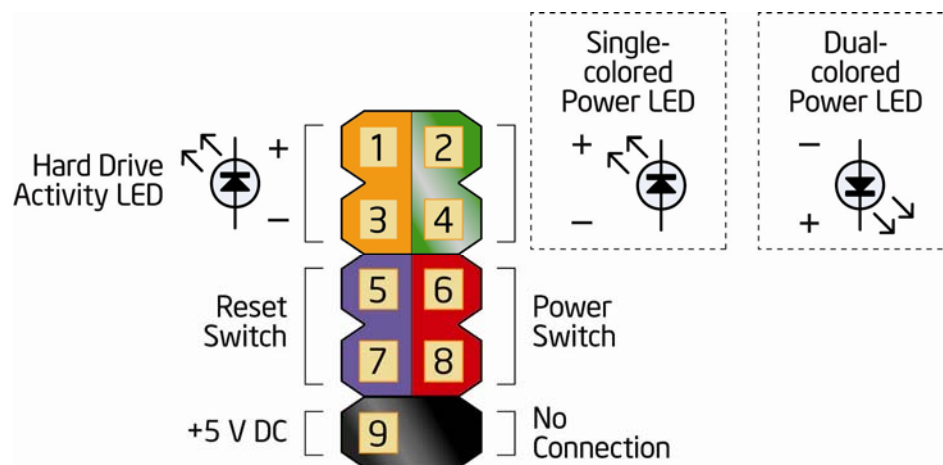

**Figure 12. Connection Diagram for Front Panel Header**

#### 2.2.2.5.1 Hard Drive Activity LED Header

Pins 1 and 3 can be connected to an LED to provide a visual indicator that data is being read from or written to a hard drive. Proper LED function requires one of the following:

- A Serial ATA hard drive or optical drive connected to an onboard Serial ATA connector
- A Parallel ATA IDE hard drive or optical drive connected to an onboard Parallel ATA IDE connector

### 2.2.2.5.2 Reset Switch Header

Pins 5 and 7 can be connected to a momentary single pole, single throw (SPST) type switch that is normally open. When the switch is closed, the board resets and runs the POST.

### 2.2.2.5.3 Power/Sleep LED Header

Pins 2 and 4 can be connected to a one- or two-color LED. Table 21 shows the possible states for a one-color LED. Table 22 shows the possible states for a two-color LED.

**Table 21. States for a One-Color Power LED**

LED State	Description
Off	Power off/sleeping
Steady Green	Running

**Table 22. States for a Two-Color Power LED**

LED State	Description
Off	Power off
Steady Green	Running
Steady Yellow	Sleeping

 **NOTE**

*The colors listed in Table 21 and Table 22 are suggested colors only. Actual LED colors are chassis-specific.*

### 2.2.2.5.4 Power Switch Header

Pins 6 and 8 can be connected to a front panel momentary-contact power switch. The switch must pull the SW\_ON# pin to ground for at least 50 ms to signal the power supply to switch on or off. (The time requirement is due to internal debounce circuitry on the board.) At least two seconds must pass before the power supply will recognize another on/off signal.

### 2.2.2.6 Front Panel USB Headers

Figure 13 is a connection diagram for the front panel USB headers.

#### INTEGRATOR'S NOTES

- The +5 V DC power on the USB headers is fused.
- Use only a front panel USB connector that conforms to the USB 2.0 specification for high-speed USB devices.

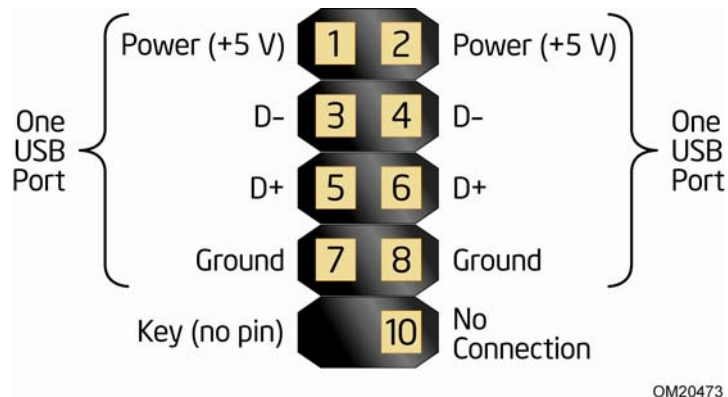

**Figure 13. Connection Diagram for Front Panel USB Headers**

### 2.2.2.7 Front Panel IEEE 1394a Header

Figure 14 is a connection diagram for the IEEE 1394a header.

#### INTEGRATOR'S NOTES

- The +12 V DC power on the IEEE 1394a header is fused.
- The IEEE 1394a header provides one IEEE 1394a port.

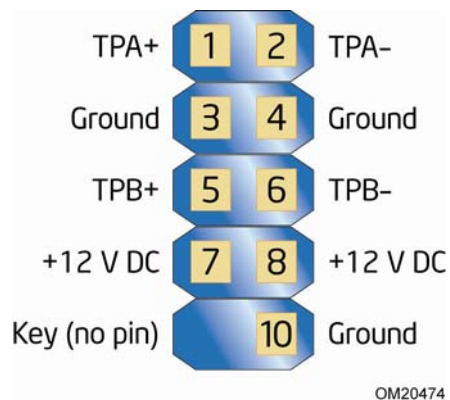

**Figure 14. Connection Diagram for IEEE 1394a Header**

## 2.3 Jumper Block



### CAUTION

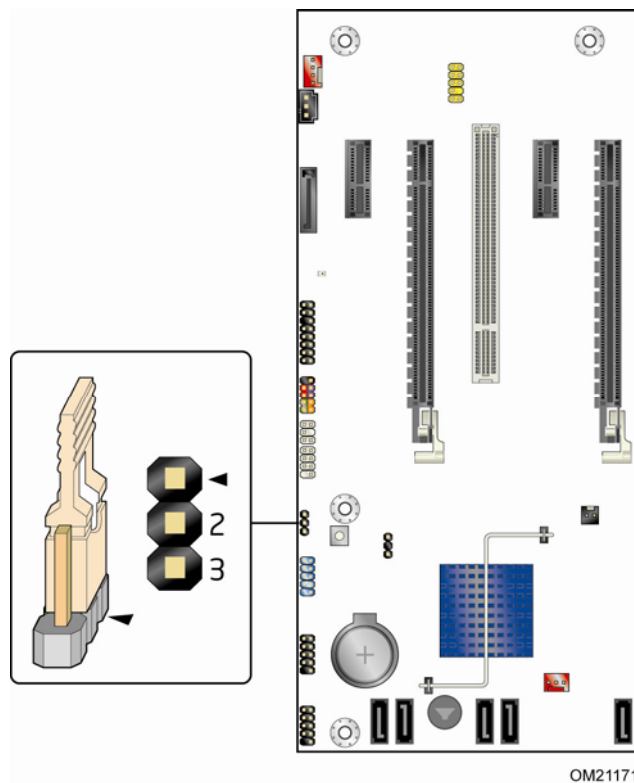

*Do not move the jumper with the power on. Always turn off the power and unplug the power cord from the computer before changing a jumper setting. Otherwise, the board could be damaged.*

Figure 15 shows the location of the jumper block. The 3-pin jumper block determines the BIOS Setup program's mode. Table 23 describes the jumper settings for the three modes: normal, configure, and recovery. When the jumper is set to configure mode and the computer is powered-up, the BIOS compares the processor version and the microcode version in the BIOS and reports if the two match.

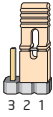
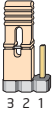

**Figure 15. Location of the Jumper Block**

**Table 23. BIOS Setup Configuration Jumper Settings**

Function/Mode	Jumper Setting		Configuration
Normal	1-2		The BIOS uses current configuration information and passwords for booting.
Configure	2-3		After the POST runs, Setup runs automatically. The maintenance menu is displayed.  Note that this Configure mode is the only way to clear the BIOS/CMOS settings. Press F9 (restore defaults) while in Configure mode to restore the BIOS/CMOS settings to their default values.
Recovery	None		The BIOS attempts to recover the BIOS configuration. A recovery CD or flash drive is required.

## 2.4 Mechanical Considerations

### 2.4.1 Form Factor

The board is designed to fit into an ATX-form-factor chassis. Figure 16 illustrates the mechanical form factor for the board. Dimensions are given in inches [millimeters]. The outer dimensions are 12.00 inches by 9.60 inches [304.80 millimeters by 243.84 millimeters]. Location of the I/O connectors and mounting holes are in compliance with the ATX specification.

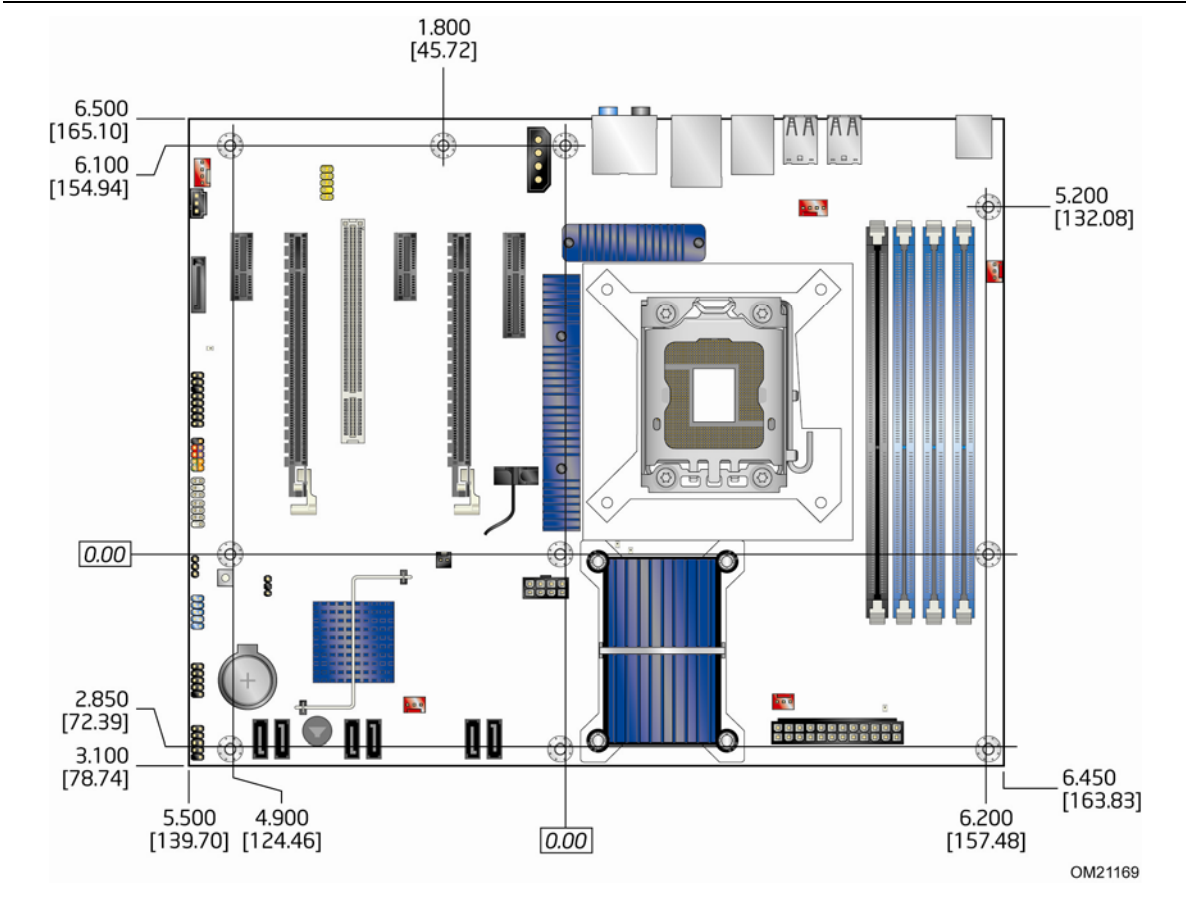

Figure 16. Board Dimensions

## 2.5 Electrical Considerations

### 2.5.1 Power Supply Considerations



#### CAUTION

The +5 V standby line from the power supply must be capable of providing adequate +5 V standby current. Failure to do so can damage the power supply. The total amount of standby current required depends on the wake devices supported and manufacturing options.

Additional power required will depend on configurations chosen by the integrator.

The power supply must comply with the indicated parameters of the ATX form factor specification.

- The potential relation between 3.3 VDC and +5 VDC power rails
- The current capability of the +5 VSB line
- All timing parameters
- All voltage tolerances

For example, for a system consisting of a supported 130 W processor (see section 1.4 on page 14 for a list of supported processors), 1 GB DDR3 RAM, one high end video card, one hard disk drive, one optical drive, and all board peripherals enabled, the minimum recommended power supply is 460 W. Table 24 lists the recommended power supply current values.

**Table 24. Recommended Power Supply Current Values**

<b>Output Voltage</b>	3.3 V	5 V	12 V1	12 V2	-12 V	5 VSB
<b>Current</b>	22 A	20 A	16 A	16 A	0.3 A	1.5 A

#### For information about

Selecting an appropriate power supply

#### Refer to

<http://support.intel.com/support/motherboards/desktop/sb/CS-026472.htm>



## 2.5.2 Fan Header Current Capability



### CAUTION

*The processor fan must be connected to the processor fan header, not to a chassis fan header. Connecting the processor fan to a chassis fan header may result in onboard component damage that will halt fan operation.*

Table 25 lists the current capability of the fan headers.

**Table 25. Fan Header Current Capability**

Fan Header	Maximum Available Current
Processor fan	2.0 A
Front chassis fan	1.5 A
IOH Fan	3.5 A (direct connect 12 V rail)
Rear chassis fan	1.5 A
Auxiliary rear chassis fan	2.0 A

## 2.5.3 Add-in Board Considerations

The board is designed to provide 2 A (average) of current for each add-in board from the +5 V rail. The total +5 V current draw for add-in boards for a fully loaded board (all six expansion slots filled) must not exceed the system's power supply +5 V maximum current or 14 A in total.

## 2.6 Thermal Considerations



### CAUTION

*A chassis with a maximum internal ambient temperature of 38 °C at the processor fan inlet is a requirement. Use a processor heat sink that provides omni-directional airflow to maintain required airflow across the processor voltage regulator area.*



### CAUTION

*Failure to ensure appropriate airflow may result in reduced performance of both the processor and/or voltage regulator or, in some instances, damage to the board. For a list of chassis that have been tested with Intel desktop boards please refer to the following website:*

<http://developer.intel.com/design/motherbd/cooling.htm>

*All responsibility for determining the adequacy of any thermal or system design remains solely with the reader. Intel makes no warranties or representations that merely following the instructions presented in this document will result in a system with adequate thermal performance.*



**CAUTION**

Ensure that the ambient temperature does not exceed the board’s maximum operating temperature. Failure to do so could cause components to exceed their maximum case temperature and malfunction. For information about the maximum operating temperature, see the environmental specifications in Section 2.8.



**CAUTION**

Ensure that proper airflow is maintained in the processor voltage regulator circuit. Failure to do so may result in damage to the voltage regulator circuit. The processor voltage regulator area (shown in Figure 17) can reach a temperature of up to 85 °C in an open chassis.

Figure 17 shows the locations of the localized high temperature zones.

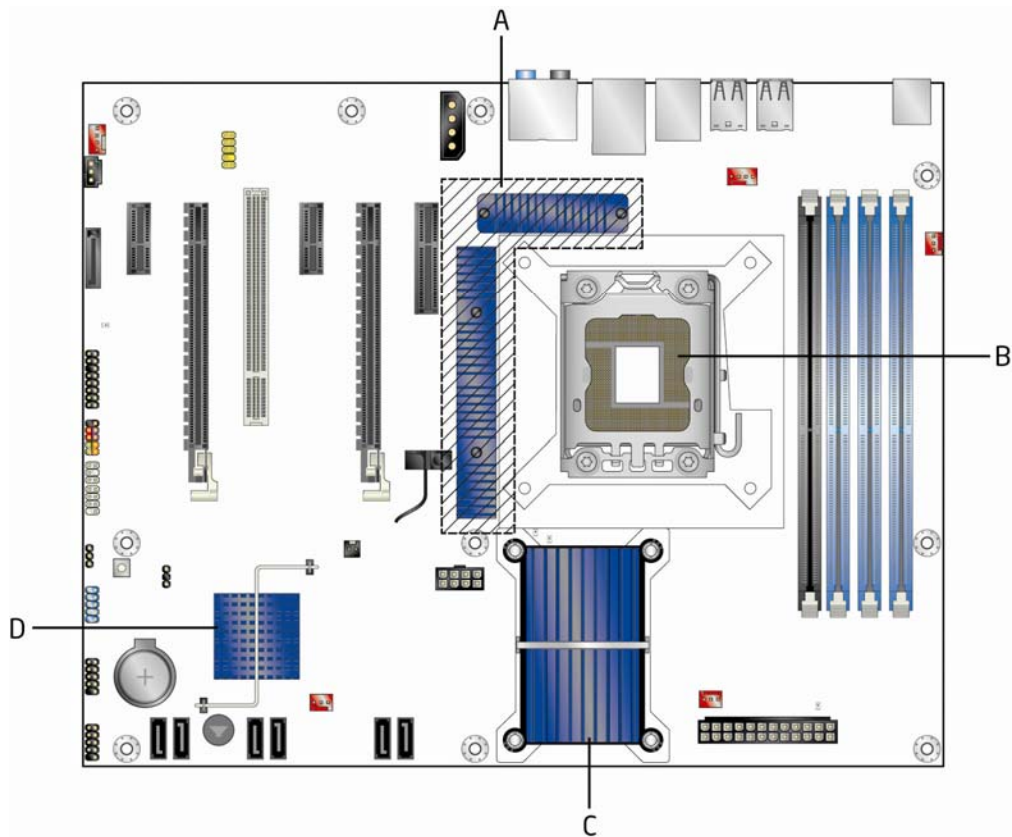

OM21170

Item	Description
A	Processor voltage regulator area
B	Processor
C	Intel 82X58 IOH
D	Intel 82801IJR ICH10R

**Figure 17. Localized High Temperature Zones**

Table 26 provides maximum case temperatures for the components that are sensitive to thermal changes. The operating temperature, current load, or operating frequency could affect case temperatures. Maximum case temperatures are important when considering proper airflow to cool the board.

**Table 26. Thermal Considerations for Components**

<b>Component</b>	<b>Maximum Case Temperature</b>
Processor	For processor case temperature, see processor datasheets and processor specification updates
Intel 82X58 IOH	105 °C (under bias)
Intel 82801IJR (ICH10R)	105 °C (under bias)

<b>For information about</b>	<b>Refer to</b>
Processor datasheets and specification updates	Section 1.3, page 14

## 2.7 Reliability

The Mean Time Between Failures (MTBF) prediction is calculated using component and subassembly random failure rates. The calculation is based on the Bellcore Reliability Prediction Procedure, TR-NWT-000332, Issue 4, September 1991. The MTBF prediction is used to estimate repair rates and spare parts requirements.

The MTBF data is calculated from predicted data at 55 °C. The MTBF for the board is 84,330.82646 hours.

## 2.8 Environmental

Table 27 lists the environmental specifications for the board.

**Table 27. Environmental Specifications**

Parameter	Specification		
<b>Temperature</b>			
Non-Operating	-40 °C to +70 °C		
Operating	0 °C to +55 °C		
<b>Shock</b>			
Unpackaged	50 g trapezoidal waveform		
	Velocity change of 170 inches/second <sup>2</sup>		
Packaged	Half sine 2 millisecond		
	Product Weight (pounds)	Free Fall (inches)	Velocity Change (inches/sec <sup>2</sup> )
	<20	36	167
	21-40	30	152
	41-80	24	136
81-100	18	118	
<b>Vibration</b>			
Unpackaged	5 Hz to 20 Hz: 0.01 g <sup>2</sup> Hz sloping up to 0.02 g <sup>2</sup> Hz		
	20 Hz to 500 Hz: 0.02 g <sup>2</sup> Hz (flat)		
Packaged	5 Hz to 40 Hz: 0.015 g <sup>2</sup> Hz (flat)		
	40 Hz to 500 Hz: 0.015 g <sup>2</sup> Hz sloping down to 0.00015 g <sup>2</sup> Hz		

## 3 Overview of BIOS Features

---

### 3.1 Introduction

The board uses an Intel BIOS that is stored in the Serial Peripheral Interface Flash Memory (SPI Flash) and can be updated using a disk-based program. The SPI Flash contains the BIOS Setup program, POST, the PCI auto-configuration utility, LAN EEPROM information, and Plug and Play support.

The BIOS displays a message during POST identifying the type of BIOS and a revision code. The initial production BIOSs are identified as SOX5810J.86A.

When the BIOS Setup configuration jumper is set to configure mode and the computer is powered-up, the BIOS compares the CPU version and the microcode version in the BIOS and reports if the two match.

The BIOS Setup program can be used to view and change the BIOS settings for the computer. The BIOS Setup program is accessed by pressing the <F2> key after the Power-On Self-Test (POST) memory test begins and before the operating system boot begins. The menu bar is shown below.

Maintenance	Main	Advanced	Performance	Security	Power	Boot	Exit
-------------	------	----------	-------------	----------	-------	------	------



#### **NOTE**

*The maintenance menu is displayed only when the board is in configure mode. Section 2.3 on page 53 shows how to put the board in configure mode.*

Table 28 lists the BIOS Setup program menu features.

**Table 28. BIOS Setup Program Menu Bar**

Maintenance	Main	Advanced	Performance	Security	Power	Boot	Exit
Clears passwords and displays processor information	Displays processor and memory configuration	Configures advanced features available through the chipset	Configures Memory, Bus and Processor overrides	Sets passwords and security features	Configures power management features and power supply controls	Selects boot options	Saves or discards changes to Setup program options

Table 29 lists the function keys available for menu screens.

**Table 29. BIOS Setup Program Function Keys**

BIOS Setup Program Function Key	Description
<<-> or <->>	Selects a different menu screen (Moves the cursor left or right)
<↑> or <↓>	Selects an item (Moves the cursor up or down)
<Tab>	Selects a field (Not implemented)
<Enter>	Executes command or selects the submenu
<F9>	Load the default configuration values for the current menu
<F10>	Save the current values and exits the BIOS Setup program
<Esc>	Exits the menu

## 3.2 BIOS Flash Memory Organization

The Serial Peripheral Interface Flash Memory (SPI Flash) includes a 16 Mbit (2048 KB) flash memory device.

## 3.3 Resource Configuration

### 3.3.1 PCI Autoconfiguration

The BIOS can automatically configure PCI devices. PCI devices may be onboard or add-in cards. Autoconfiguration lets a user insert or remove PCI cards without having to configure the system. When a user turns on the system after adding a PCI card, the BIOS automatically configures interrupts, the I/O space, and other system resources. Any interrupts set to Available in Setup are considered to be available for use by the add-in card.

## 3.4 System Management BIOS (SMBIOS)

SMBIOS is a Desktop Management Interface (DMI) compliant method for managing computers in a managed network.

The main component of SMBIOS is the Management Information Format (MIF) database, which contains information about the computing system and its components. Using SMBIOS, a system administrator can obtain the system types, capabilities, operational status, and installation dates for system components. The MIF database defines the data and provides the method for accessing this information. The BIOS enables applications such as third-party management software to use SMBIOS. The BIOS stores and reports the following SMBIOS information:

- BIOS data, such as the BIOS revision level
- Fixed-system data, such as peripherals, serial numbers, and asset tags
- Resource data, such as memory size, cache size, and processor speed
- Dynamic data, such as event detection and error logging

Non-Plug and Play operating systems require an additional interface for obtaining the SMBIOS information. The BIOS supports an SMBIOS table interface for such operating systems. Using this support, an SMBIOS service-level application running on a non-Plug and Play operating system can obtain the SMBIOS information. Additional board information can be found in the BIOS under the Additional Information header under the Main BIOS page.

## 3.5 Legacy USB Support

Legacy USB support enables USB devices to be used even when the operating system's USB drivers are not yet available. Legacy USB support is used to access the BIOS Setup program, and to install an operating system that supports USB. By default, Legacy USB support is set to Enabled.

Legacy USB support operates as follows:

1. When you apply power to the computer, legacy support is disabled.
2. POST begins.
3. Legacy USB support is enabled by the BIOS allowing you to use a USB keyboard to enter and configure the BIOS Setup program and the maintenance menu.
4. POST completes.
5. The operating system loads. While the operating system is loading, USB keyboards and mice are recognized and may be used to configure the operating system. (Keyboards and mice are not recognized during this period if Legacy USB support was set to Disabled in the BIOS Setup program.)
6. After the operating system loads the USB drivers, all legacy and non-legacy USB devices are recognized by the operating system, and Legacy USB support from the BIOS is no longer used.
7. Additional USB legacy feature options can be access by using Intel Integrator Toolkit.

To install an operating system that supports USB, verify that Legacy USB support in the BIOS Setup program is set to Enabled and follow the operating system's installation instructions.

## 3.6 BIOS Updates

The BIOS can be updated using either of the following utilities, which are available on the Intel World Wide Web site:

- Intel® Express BIOS Update utility, which enables automated updating while in the Windows environment. Using this utility, the BIOS can be updated from a file on a hard disk, a USB drive (a flash drive or a USB hard drive), or a CD-ROM, or from the file location on the Web.
- Intel® Flash Memory Update Utility, which requires booting from DOS. Using this utility, the BIOS can be updated from a file on a hard disk, a USB drive (a flash drive or a USB hard drive), or a CD-ROM.

Both utilities verify that the updated BIOS matches the target system to prevent accidentally installing an incompatible BIOS.



### NOTE

*Review the instructions distributed with the upgrade utility before attempting a BIOS update.*

<b>For information about</b>	<b>Refer to</b>
BIOS update utilities	<a href="http://support.intel.com/support/motherboards/desktop/sb/CS-022312.htm">http://support.intel.com/support/motherboards/desktop/sb/CS-022312.htm</a>

### 3.6.1 Language Support

The BIOS Setup program and help messages are supported in US English. Additional languages are available in the Integrator's Toolkit utility. Check the Intel website for details.



### 3.6.2 Custom Splash Screen

During POST, an Intel® splash screen is displayed by default. This splash screen can be augmented with a custom splash screen. The Intel Integrator’s Toolkit that is available from Intel can be used to create a custom splash screen.



**NOTE**

*If you add a custom splash screen, it will share space with the Intel branded logo.*

For information about	Refer to
Intel® Integrator Toolkit	<a href="http://developer.intel.com/design/motherbd/software/itk/">http://developer.intel.com/design/motherbd/software/itk/</a>
Additional Intel® software tools	<a href="http://developer.intel.com/products/motherboard/DX58SO/tools.htm">http://developer.intel.com/products/motherboard/DX58SO/tools.htm</a> and <a href="http://developer.intel.com/design/motherbd/software.htm">http://developer.intel.com/design/motherbd/software.htm</a>

## 3.7 BIOS Recovery

It is unlikely that anything will interrupt a BIOS update; however, if an interruption occurs, the BIOS could be damaged. Table 30 lists the drives and media types that can and cannot be used for BIOS recovery. The BIOS recovery media does not need to be made bootable.

**Table 30. Acceptable Drives/Media Types for BIOS Recovery**

Media Type	Can be used for BIOS recovery?
CD-ROM drive connected to the Parallel ATA interface	Yes
CD-ROM drive connected to the Serial ATA interface	Yes
USB removable drive (a USB Flash Drive, for example)	Yes
USB diskette drive (with a 1.44 MB diskette)	No
USB hard disk drive	No
Legacy diskette drive (with a 1.44 MB diskette) connected to the legacy diskette drive interface	No

For information about	Refer to
BIOS recovery	<a href="http://www.intel.com/support/motherboards/desktop/sb/cs-023360.htm">http://www.intel.com/support/motherboards/desktop/sb/cs-023360.htm</a>

## 3.8 Boot Options

In the BIOS Setup program, the user can choose to boot from a diskette drive, hard drive, USB drive, USB flash drive, CD-ROM, or the network. The default setting is for the diskette drive to be the first boot device, the hard drive second, and the ATAPI CD-ROM third. If enabled, the last default boot device is the network.

### 3.8.1 CD-ROM Boot

Booting from CD-ROM is supported in compliance to the El Torito bootable CD-ROM format specification. Under the Boot menu in the BIOS Setup program, ATAPI CD-ROM is listed as a boot device. Boot devices are defined in priority order. Accordingly, if there is not a bootable CD in the CD-ROM drive, the system will attempt to boot from the next defined drive.

### 3.8.2 Network Boot

The network can be selected as a boot device. This selection allows booting from the onboard LAN or a network add-in card with a remote boot ROM installed.

Pressing the <F12> key during POST automatically forces booting from the LAN. To use this key during POST, the User Access Level in the BIOS Setup program's Security menu must be set to Full.

### 3.8.3 Booting Without Attached Devices

For use in embedded applications, the BIOS has been designed so that after passing the POST, the operating system loader is invoked even if the following devices are not present:

- Video adapter
- Keyboard
- Mouse

### 3.8.4 Changing the Default Boot Device During POST

Pressing the <F10> key during POST causes a boot device menu to be displayed. This menu displays the list of available boot devices (as set in the BIOS setup program's Boot Device Priority Submenu). Table 31 lists the boot device menu options.

**Table 31. Boot Device Menu Options**

Boot Device Menu Function Keys	Description
<↑> or <↓>	Selects a default boot device
<Enter>	Exits the menu, saves changes, and boots from the selected device
<Esc>	Exits the menu without saving changes

## 3.9 Adjusting Boot Speed

These factors affect system boot speed:

- Selecting and configuring peripherals properly
- Optimized BIOS boot parameters

### 3.9.1 Peripheral Selection and Configuration

The following techniques help improve system boot speed:

- Choose a hard drive with parameters such as “power-up to data ready” less than eight seconds, that minimize hard drive startup delays.
- Select a CD-ROM drive with a fast initialization rate. This rate can influence POST execution time.
- Eliminate unnecessary add-in adapter features, such as logo displays, screen repaints, or mode changes in POST. These features may add time to the boot process.
- Try different monitors. Some monitors initialize and communicate with the BIOS more quickly, which enables the system to boot more quickly.

### 3.9.2 BIOS Boot Optimizations

Use of the following BIOS Setup program settings reduces the POST execution time.

- In the Boot Menu, set the hard disk drive as the first boot device. As a result, the POST does not first seek a diskette drive, which saves about one second from the POST execution time.
- In the Peripheral Configuration submenu, disable the LAN device if it will not be used. This can reduce up to four seconds of option ROM boot time.



#### **NOTE**

*It is possible to optimize the boot process to the point where the system boots so quickly that the Intel logo screen (or a custom logo splash screen) will not be seen. Monitors and hard disk drives with minimum initialization times can also contribute to a boot time that might be so fast that necessary logo screens and POST messages cannot be seen.*

*This boot time may be so fast that some drives might be not be initialized at all. If this condition should occur, it is possible to introduce a programmable delay ranging from zero to 30 seconds by 5 second increments (using the Hard Disk Pre-Delay feature of the Advanced Menu in the Drive Configuration Submenu of the BIOS Setup program).*

## 3.10 BIOS Security Features

The BIOS includes security features that restrict access to the BIOS Setup program and who can boot the computer. A supervisor password and a user password can be set for the BIOS Setup program and for booting the computer, with the following restrictions:

- The supervisor password gives unrestricted access to view and change all the Setup options in the BIOS Setup program. This is the supervisor mode.
- The user password gives restricted access to view and change Setup options in the BIOS Setup program. This is the user mode.
- If only the supervisor password is set, pressing the <Enter> key at the password prompt of the BIOS Setup program allows the user restricted access to Setup.
- If both the supervisor and user passwords are set, users can enter either the supervisor password or the user password to access Setup. Users have access to Setup respective to which password is entered.
- Setting the user password restricts who can boot the computer. The password prompt will be displayed before the computer is booted. If only the supervisor password is set, the computer boots without asking for a password. If both passwords are set, the user can enter either password to boot the computer.
- For enhanced security, use different passwords for the supervisor and user passwords.
- Valid password characters are A-Z, a-z, and 0-9. Passwords may be up to 16 characters in length.

Table 32 shows the effects of setting the supervisor password and user password. This table is for reference only and is not displayed on the screen.

**Table 32. Supervisor and User Password Functions**

<b>Password Set</b>	<b>Supervisor Mode</b>	<b>User Mode</b>	<b>Setup Options</b>	<b>Password to Enter Setup</b>	<b>Password During Boot</b>
Neither	Can change all options (Note)	Can change all options (Note)	None	None	None
Supervisor only	Can change all options	Can change a limited number of options	Supervisor Password	Supervisor	None
User only	N/A	Can change all options	Enter Password Clear User Password	User	User
Supervisor and user set	Can change all options	Can change a limited number of options	Supervisor Password Enter Password	Supervisor or user	Supervisor or user

Note: If no password is set, any user can change all Setup options.

## 3.11 BIOS Performance Features

The BIOS includes the following options to provide custom performance enhancements when using Intel Core i7 Processors.

- Processor frequency adjustment
- Processor voltage adjustment
- Memory clock adjustments
- Memory voltage adjustments
- QPI Bus voltage adjustment
- VTT voltage adjustment



## 4 Error Messages and Beep Codes

---

### 4.1 Speaker

The board-mounted speaker provides audible error code (beep code) information during POST.

<b>For information about</b>	<b>Refer to</b>
The location of the onboard speaker	Figure 1, page 11

### 4.2 BIOS Beep Codes

Whenever a recoverable error occurs during POST, the BIOS displays an error message describing the problem (see Table 33).

**Table 33. Beep Codes**

Type	Pattern	Frequency
Memory error	Three long beeps	1280 Hz
Thermal warning	Four alternating beeps: High tone, low tone, high tone, low tone	High tone: 2000 Hz Low tone: 1600 Hz

### 4.3 BIOS Error Messages

Table 34 lists the error messages and provides a brief description of each.

**Table 34. BIOS Error Messages**

Error Message	Explanation
CMOS Battery Low	The battery may be losing power. Replace the battery soon.
CMOS Checksum Bad	The CMOS checksum is incorrect. CMOS memory may have been corrupted. Run Setup to reset values.
Memory Size Decreased	Memory size has decreased since the last boot. If no memory was removed, then memory may be bad.
No Boot Device Available	System did not find a device to boot.

## 4.4 Port 80h POST Codes

During the POST, the BIOS generates diagnostic progress codes (POST codes) to I/O port 80h. If the POST fails, execution stops and the last POST code generated is left at port 80h. This code is useful for determining the point where an error occurred.

Displaying the POST codes requires a PCI bus add-in card, often called a POST card. The POST card can decode the port and display the contents on a medium such as a seven-segment display.



### NOTE

*The POST card must be installed in PCI bus connector 1.*

The following tables provide information about the POST codes generated by the BIOS:

- Table 35 lists the Port 80h POST code ranges
- Table 36 lists the Port 80h POST codes themselves
- Table 37 lists the Port 80h POST sequence



### NOTE

*In the tables listed above, all POST codes and range values are listed in hexadecimal.*

**Table 35. Port 80h POST Code Ranges**

Range	Category/Subsystem
00 – 0F	Debug codes: Can be used by any PEIM/driver for debug.
10 – 1F	Host Processors: 1F is an unrecoverable CPU error.
20 – 2F	Memory/Chipset: 2F is no memory detected or no useful memory detected.
30 – 3F	Recovery: 3F indicated recovery failure.
40 – 4F	Reserved for future use.
50 – 5F	I/O Busses: PCI, USB, ATA, etc. 5F is an unrecoverable error. Start with PCI.
60 – 6F	Reserved for future use (for new busses).
70 – 7F	Output Devices: All output consoles. 7F is an unrecoverable error.
80 – 8F	Reserved for future use (new output console codes).
90 – 9F	Input devices: Keyboard/Mouse. 9F is an unrecoverable error.
A0 – AF	Reserved for future use (new input console codes).
B0 – BF	Boot Devices: Includes fixed media and removable media. BF is an unrecoverable error.
C0 – CF	Reserved for future use.
D0 – DF	Boot device selection.
E0 – FF	E0 – EE: Miscellaneous codes. See Table 36. EF: boot/S3 resume failure. F0 – FF: FF processor exception.



**Table 36. Port 80h POST Codes**

<b>POST Code</b>	<b>Description of POST Operation</b>
<b>Host Processor</b>	
10	Power-on initialization of the host processor (Boot Strap Processor)
11	Host processor cache initialization (including APs)
12	Starting Application processor initialization
13	SMM initialization
<b>Chipset</b>	
21	Initializing a chipset component
<b>Memory</b>	
22	Reading SPD from memory DIMMs
23	Detecting presence of memory DIMMs
24	Programming timing parameters in the memory controller and the DIMMs
25	Configuring memory
26	Optimizing memory settings
27	Initializing memory, such as ECC init
29	Memory testing completed
<b>PCI Bus</b>	
50	Enumerating PCI busses
51	Allocating resources to PCI bus
52	Hot Plug PCI controller initialization
53 – 57	Reserved for PCI Bus
<b>USB</b>	
58	Resetting USB bus
59	Reserved for USB
<b>ATA/ATAPI/SATA</b>	
5A	Resetting PATA/SATA bus and all devices
5B	Reserved for ATA
<b>SMBus</b>	
5C	Resetting SMBus
5D	Reserved for SMBus
<b>Local Console</b>	
70	Resetting the VGA controller
71	Disabling the VGA controller
72	Enabling the VGA controller
<b>Remote Console</b>	
78	Resetting the console controller
79	Disabling the console controller
7A	Enabling the console controller

continued

**Table 36. Port 80h POST Codes** (continued)

<b>POST Code</b>	<b>Description of POST Operation</b>
<b>Keyboard (USB)</b>	
90	Resetting keyboard
91	Disabling keyboard
92	Detecting presence of keyboard
93	Enabling the keyboard
94	Clearing keyboard input buffer
95	Instructing keyboard controller to run Self Test (PS/2 only)
<b>Mouse (USB)</b>	
98	Resetting mouse
99	Disabling mouse
9A	Detecting presence of mouse
9B	Enabling mouse
<b>Fixed Media</b>	
B0	Resetting fixed media
B1	Disabling fixed media
B2	Detecting presence of a fixed media (IDE hard drive detection etc.)
B3	Enabling/configuring a fixed media
<b>Removable Media</b>	
B8	Resetting removable media
B9	Disabling removable media
BA	Detecting presence of a removable media (IDE, CD-ROM detection, etc.)
BC	Enabling/configuring a removable media
<b>BDS</b>	
Dy	Trying boot selection y (y=0 to 15)
<b>PEI Core</b>	
E0	Started dispatching PEIMs (emitted on first report of EFI_SW_PC_INIT_BEGIN EFI_SW_PEI_PC_HANDOFF_TO_NEXT)
E2	Permanent memory found
E1, E3	Reserved for PEI/PEIMs
<b>DXE Core</b>	
E4	Entered DXE phase
E5	Started dispatching drivers
E6	Started connecting drivers

continued

**Table 36. Port 80h POST Codes** (continued)

<b>POST Code</b>	<b>Description of POST Operation</b>
	DXE Drivers
E7	Waiting for user input
E8	Checking password
E9	Entering BIOS setup
EB	Calling Legacy Option ROMs
	Runtime Phase/EFI OS Boot
F4	Entering Sleep state
F5	Exiting Sleep state
F8	EFI boot service ExitBootServices ( ) has been called
F9	EFI runtime service SetVirtualAddressMap ( ) has been called
FA	EFI runtime service ResetSystem ( ) has been called
	PEIMs/Recovery
30	Crisis Recovery has initiated per user request
31	Crisis Recovery has initiated by software (corrupt flash)
34	Loading recovery capsule
35	Handing off control to the recovery capsule
3F	Unable to recover

**Table 37. Typical Port 80h POST Sequence**

<b>POST Code</b>	<b>Description</b>
21	Initializing a chipset component
22	Reading SPD from memory DIMMs
23	Detecting presence of memory DIMMs
25	Configuring memory
28	Testing memory
34	Loading recovery capsule
E4	Entered DXE phase
12	Starting application processor initialization
13	SMM initialization
50	Enumerating PCI busses
51	Allocating resourced to PCI bus
92	Detecting the presence of the keyboard
90	Resetting keyboard
94	Clearing keyboard input buffer
95	Keyboard Self Test
EB	Calling Video BIOS
58	Resetting USB bus
5A	Resetting PATA/SATA bus and all devices
92	Detecting the presence of the keyboard
90	Resetting keyboard
94	Clearing keyboard input buffer
5A	Resetting PATA/SATA bus and all devices
28	Testing memory
90	Resetting keyboard
94	Clearing keyboard input buffer
E7	Waiting for user input
01	INT 19
00	Ready to boot

# 5 Regulatory Compliance and Battery Disposal Information

---

## 5.1 Regulatory Compliance

This section contains the following regulatory compliance information for Intel Desktop Board DX58SO:

- Safety standards
- European Union Declaration of Conformity statement
- Product Ecology statements
- Electromagnetic Compatibility (EMC) standards
- Product certification markings

### 5.1.1 Safety Standards

Intel Desktop Board DX58SO complies with the safety standards stated in Table 38 when correctly installed in a compatible host system.

**Table 38. Safety Standards**

<b>Standard</b>	<b>Title</b>
CSA/UL 60950-1, First Edition	Information Technology Equipment – Safety - Part 1: General Requirements (USA and Canada)
EN 60950-1:2006, Second Edition	Information Technology Equipment – Safety - Part 1: General Requirements (European Union)
IEC 60950-1:2005, Second Edition	Information Technology Equipment – Safety - Part 1: General Requirements (International)

## 5.1.2 European Union Declaration of Conformity Statement

We, Intel Corporation, declare under our sole responsibility that the product Intel® Desktop Board DX58SO is in conformity with all applicable essential requirements necessary for CE marking, following the provisions of the European Council Directive 2004/108/EC (EMC Directive) and 2006/95/EC (Low Voltage Directive).

The product is properly CE marked demonstrating this conformity and is for distribution within all member states of the EU with no restrictions.



This product follows the provisions of the European Directives 2004/108/EC and 2006/95/EC.

**Čeština** Tento výrobek odpovídá požadavkům evropských směrnic 2004/108/EC a 2006/95/EC.

**Dansk** Dette produkt er i overensstemmelse med det europæiske direktiv 2004/108/EC & 2006/95/EC.

**Dutch** Dit product is in navolging van de bepalingen van Europees Directief 2004/108/EC & 2006/95/EC.

**Eesti** Antud toode vastab Euroopa direktiivides 2004/108/EC ja 2006/95/EC kehtestatud nõuetele.

**Suomi** Tämä tuote noudattaa EU-direktiivin 2004/108/EC & 2006/95/EC määräyksiä.

**Français** Ce produit est conforme aux exigences de la Directive Européenne 2004/108/EC & 2006/95/EC.

**Deutsch** Dieses Produkt entspricht den Bestimmungen der Europäischen Richtlinie 2004/108/EC & 2006/95/EC.

**Ελληνικά** Το παρόν προϊόν ακολουθεί τις διατάξεις των Ευρωπαϊκών Οδηγιών 2004/108/EC και 2006/95/EC.

**Magyar** E termék megfelel a 2004/108/EC és 2006/95/EC Európai Irányelv előírásainak.

**Icelandic** Þessi vara stenst reglugerð Evrópska Efnahags Bandalagsins númer 2004/108/EC & 2006/95/EC.

**Italiano** Questo prodotto è conforme alla Direttiva Europea 2004/108/EC & 2006/95/EC.

**Latviešu** Šis produkts atbilst Eiropas Direktīvu 2004/108/EC un 2006/95/EC noteikumiem.

**Lietuvių** Šis produktas atitinka Europos direktyvų 2004/108/EC ir 2006/95/EC nuostatas.

**Malti** Dan il-prodott hu konformi mal-provvedimenti tad-Direttivi Ewropej 2004/108/EC u 2006/95/EC.

**Norsk** Dette produktet er i henhold til bestemmelsene i det europeiske direktivet 2004/108/EC & 2006/95/EC.

**Polski** Niniejszy produkt jest zgodny z postanowieniami Dyrektyw Unii Europejskiej 2004/108/EC i 73/23/EWG.

**Portuguese** Este produto cumpre com as normas da Diretiva Europeia 2004/108/EC & 2006/95/EC.

**Español** Este producto cumple con las normas del Directivo Europeo 2004/108/EC & 2006/95/EC.

**Slovensky** Tento produkt je v súlade s ustanoveniami európskych direktív 2004/108/EC a 2006/95/EC.

**Slovenščina** Izdelek je skladen z določbami evropskih direktiv 2004/108/EC in 2006/95/EC.

**Svenska** Denna produkt har tillverkats i enlighet med EG-direktiv 2004/108/EC & 2006/95/EC.

**Türkçe** Bu ürün, Avrupa Birliği'nin 2004/108/EC ve 2006/95/EC yönergelerine uyar.

### 5.1.3 Product Ecology Statements

The following information is provided to address worldwide product ecology concerns and regulations.

#### 5.1.3.1 Disposal Considerations

This product contains the following materials that may be regulated upon disposal: lead solder on the printed wiring board assembly.

#### 5.1.3.2 Recycling Considerations

As part of its commitment to environmental responsibility, Intel has implemented the Intel Product Recycling Program to allow retail consumers of Intel's branded products to return used products to selected locations for proper recycling.

Please consult the [http://www.intel.com/intel/other/ehs/product\\_ecology](http://www.intel.com/intel/other/ehs/product_ecology) for the details of this program, including the scope of covered products, available locations, shipping instructions, terms and conditions, etc.

#### 中文

作为其对环境责任之承诺的部分，英特尔已实施 Intel Product Recycling Program（英特尔产品回收计划），以允许英特尔品牌产品的零售消费者将使用过的产品退还至指定地点作恰当的重复使用处理。

请参考[http://www.intel.com/intel/other/ehs/product\\_ecology](http://www.intel.com/intel/other/ehs/product_ecology)了解此计划的详情，包括涉及产品之范围、回收地点、运送指导、条款和条件等。

#### Deutsch

Als Teil von Intels Engagement für den Umweltschutz hat das Unternehmen das Intel Produkt-Recyclingprogramm implementiert, das Einzelhandelskunden von Intel Markenprodukten ermöglicht, gebrauchte Produkte an ausgewählte Standorte für ordnungsgemäßes Recycling zurückzugeben.

Details zu diesem Programm, einschließlich der darin eingeschlossenen Produkte, verfügbaren Standorte, Versandanweisungen, Bedingungen usw., finden Sie auf der [http://www.intel.com/intel/other/ehs/product\\_ecology](http://www.intel.com/intel/other/ehs/product_ecology)

### **Español**

Como parte de su compromiso de responsabilidad medioambiental, Intel ha implantado el programa de reciclaje de productos Intel, que permite que los consumidores al detalle de los productos Intel devuelvan los productos usados en los lugares seleccionados para su correspondiente reciclado.

Consulte la [http://www.intel.com/intel/other/ehs/product\\_ecology](http://www.intel.com/intel/other/ehs/product_ecology) para ver los detalles del programa, que incluye los productos que abarca, los lugares disponibles, instrucciones de envío, términos y condiciones, etc.

### **Français**

Dans le cadre de son engagement pour la protection de l'environnement, Intel a mis en œuvre le programme Intel Product Recycling Program (Programme de recyclage des produits Intel) pour permettre aux consommateurs de produits Intel de recycler les produits usés en les retournant à des adresses spécifiées.

Visitez la page Web [http://www.intel.com/intel/other/ehs/product\\_ecology](http://www.intel.com/intel/other/ehs/product_ecology) pour en savoir plus sur ce programme, à savoir les produits concernés, les adresses disponibles, les instructions d'expédition, les conditions générales, etc.

### **日本語**

インテルでは、環境保護活動の一環として、使い終わったインテルブランド製品を指定の場所へ返送していただき、リサイクルを適切に行えるよう、インテル製品リサイクルプログラムを発足させました。

対象製品、返送先、返送方法、ご利用規約など、このプログラムの詳細情報は、[http://www.intel.com/intel/other/ehs/product\\_ecology](http://www.intel.com/intel/other/ehs/product_ecology) (英語)をご覧ください。

### **Malay**

Sebagai sebahagian daripada komitmennya terhadap tanggungjawab persekitaran, Intel telah melaksanakan Program Kitar Semula Produk untuk membenarkan pengguna-pengguna runcit produk jenama Intel memulangkan produk terguna ke lokasi-lokasi terpilih untuk dikitar semula dengan betul.

Sila rujuk [http://www.intel.com/intel/other/ehs/product\\_ecology](http://www.intel.com/intel/other/ehs/product_ecology) untuk mendapatkan butir-butir program ini, termasuklah skop produk yang dirangkumi, lokasi-lokasi tersedia, arahan penghantaran, terma & syarat, dsb.

### **Portuguese**

Como parte deste compromisso com o respeito ao ambiente, a Intel implementou o Programa de Reciclagem de Produtos para que os consumidores finais possam enviar produtos Intel usados para locais selecionados, onde esses produtos são reciclados de maneira adequada.

Consulte o site [http://www.intel.com/intel/other/ehs/product\\_ecology](http://www.intel.com/intel/other/ehs/product_ecology) (em Inglês) para obter os detalhes sobre este programa, inclusive o escopo dos produtos cobertos, os locais disponíveis, as instruções de envio, os termos e condições, etc.



### **Russian**

В качестве части своих обязательств к окружающей среде, в Intel создана программа утилизации продукции Intel (Product Recycling Program) для предоставления конечным пользователям марок продукции Intel возможности возврата используемой продукции в специализированные пункты для должной утилизации.

Пожалуйста, обратитесь на веб-сайт [http://www.intel.com/intel/other/ehs/product\\_ecology](http://www.intel.com/intel/other/ehs/product_ecology) за информацией об этой программе, принимаемых продуктах, местах приема, инструкциях об отправке, положениях и условиях и т.д.

### **Türkçe**

Intel, çevre sorumluluğuna bağlılığının bir parçası olarak, perakende tüketicilerin Intel markalı kullanılmış ürünlerini belirlenmiş merkezlere iade edip uygun şekilde geri dönüştürmesini amaçlayan Intel Ürünleri Geri Dönüşüm Programı'nı uygulamaya koymuştur.

Bu programın ürün kapsamı, ürün iade merkezleri, nakliye talimatları, kayıtlar ve şartlar v.s dahil bütün ayrıntılarını öğrenmek için lütfen [http://www.intel.com/intel/other/ehs/product\\_ecology](http://www.intel.com/intel/other/ehs/product_ecology)

Web sayfasına gidin.

### **5.1.3.3 Lead Free Desktop Board**



This Intel Desktop Board is a European Union Restriction of Hazardous Substances (EU RoHS Directive 2002/95/EC) compliant product. EU RoHS restricts the use of six materials. One of the six restricted materials is lead.

This Intel Desktop Board is lead free although certain discrete components used on the board contain a small amount of lead which is necessary for component performance and/or reliability. This Intel Desktop Board is referred to as "Lead-free second level interconnect." The board substrate and the solder connections from the board to the components (second-level connections) are all lead free.

China bans the same substances and has the same limits as EU RoHS; however it requires different product marking and controlled substance information. The required mark shows the Environmental Friendly Usage Period (EFUP). The EFUP is defined as the number of years for which controlled listed substances will not leak or chemically deteriorate while in the product.

Table 39 shows the various forms of the "Lead-Free 2<sup>nd</sup> Level Interconnect" mark as it appears on the board and accompanying collateral.

**Table 39. Lead-Free Board Markings**

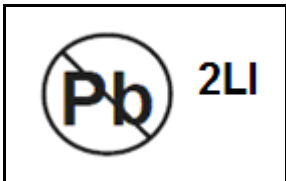
Description	Mark
<p>Lead-Free 2<sup>nd</sup> Level Interconnect:                      This symbol is used to identify electrical and electronic assemblies and components in which the lead (Pb) concentration level in the desktop board substrate and the solder connections from the board to the components (second-level interconnect) is not greater than 0.1% by weight (1000 ppm).</p>	
	<p>or</p>
	
<p>or</p>	
	

## 5.1.4 EMC Regulations

Intel Desktop Board DX58SO complies with the EMC regulations stated in Table 40 when correctly installed in a compatible host system.

**Table 40. EMC Regulations**

Regulation	Title
FCC 47 CFR Part 15, Subpart B	Title 47 of the Code of Federal Regulations, Part15, Subpart B, Radio Frequency Devices. (USA)
ICES-003 Issue 4 (Class B)	Interference-Causing Equipment Standard, Digital Apparatus. (Canada)
EN55022:2006 (Class B)	Limits and methods of measurement of Radio Interference Characteristics of Information Technology Equipment. (European Union)
EN55024:1998 (Class B)	Information Technology Equipment – Immunity Characteristics Limits and methods of measurement. (European Union)
EN55022:2006 (Class B)	Australian Communications Authority, Standard for Electromagnetic Compatibility. (Australia and New Zealand)
CISPR 22:2005 +A1:2005 +A2:2006 (Class B)	Limits and methods of measurement of Radio Disturbance Characteristics of Information Technology Equipment. (International)
CISPR 24:1997 +A1:2001 +A2:2002 (Class B)	Information Technology Equipment – Immunity Characteristics – Limits and Methods of Measurement. (International)
VCCI V-3/2007.04, V-4/2007.04, Class B	Voluntary Control for Interference by Information Technology Equipment. (Japan)

Japanese Kanji statement translation: this is a Class B product based on the standard of the Voluntary Control Council for Interference from Information Technology Equipment (VCCI). If this is used near a radio or television receiver in a domestic environment, it may cause radio interference. Install and use the equipment according to the instruction manual.

この装置は、情報処理装置等電波障害自主規制協議会（VCCI）の基準に基づくクラスB情報技術装置です。この装置は、家庭環境で使用することを目的としていますが、この装置がラジオやテレビジョン受信機に近接して使用されると、受信障害を引き起こすことがあります。  
取扱説明書に従って正しい取り扱いをして下さい。









Korean Class B statement translation: this is household equipment that is certified to comply with EMC requirements. You may use this equipment in residential environments and other non-residential environments.

이 기기는 가정용으로 전자파적합등록을 한 기기로서  
주거지역에서는 물론 모든 지역에서 사용할 수 있습니다.

### 5.1.5 Product Certification Markings (Board Level)

Intel Desktop Board DX58SO has the product certification markings shown in Table 41:

**Table 41. Product Certification Markings**

Description	Mark
UL joint US/Canada Recognized Component mark. Includes adjacent UL file number for Intel desktop boards: E210882.	
FCC Declaration of Conformity logo mark for Class B equipment. Includes Intel name and DX58SO model designation.	
CE mark. Declaring compliance to European Union (EU) EMC directive and Low Voltage directive.	
Australian Communications Authority (ACA) and New Zealand Radio Spectrum Management (NZ RSM) C-tick mark. Includes adjacent Intel supplier code number, N-232.	
Japan VCCI (Voluntary Control Council for Interference) mark.	
S. Korea MIC (Ministry of Information and Communication) mark. Includes adjacent MIC certification number: CPU-DX58SO (B)	
Taiwan BSMI (Bureau of Standards, Metrology and Inspections) mark. Includes adjacent Intel company number, D33025.	
Printed wiring board manufacturer's recognition mark. Consists of a unique UL recognized manufacturer's logo, along with a flammability rating (solder side).	V-0
China RoHS/Environmentally Friendly Use Period Logo: This is an example of the symbol used on Intel Desktop Boards and associated collateral. The color of the mark may vary depending upon the application. The Environmental Friendly Usage Period (EFUP) for Intel Desktop Boards has been determined to be 10 years.	

## 5.2 Battery Disposal Information



### **CAUTION**

*Risk of explosion if the battery is replaced with an incorrect type. Batteries should be recycled where possible. Disposal of used batteries must be in accordance with local environmental regulations.*



### **PRECAUTION**

*Risque d'explosion si la pile usagée est remplacée par une pile de type incorrect. Les piles usagées doivent être recyclées dans la mesure du possible. La mise au rebut des piles usagées doit respecter les réglementations locales en vigueur en matière de protection de l'environnement.*



### **FORHOLDSREGEL**

*Eksplussionsfare, hvis batteriet erstattes med et batteri af en forkert type. Batterier bør om muligt genbruges. Bortskaffelse af brugte batterier bør foregå i overensstemmelse med gældende miljølovgivning.*



### **OBS!**

*Det kan oppstå eksplosjonsfare hvis batteriet skiftes ut med feil type. Brukte batterier bør kastes i henhold til gjeldende miljølovgivning.*



### **VIKTIGT!**

*Risk för explosion om batteriet ersätts med felaktig batterityp. Batterier ska kasseras enligt de lokala miljövårdsbestämmelserna.*



### **VARO**

*Räjähdyksvaara, jos pariston tyyppi on väärä. Paristot on kierrätettävä, jos se on mahdollista. Käytetyt paristot on hävitettävä paikallisten ympäristömääräysten mukaisesti.*



### **VORSICHT**

*Bei falschem Einsetzen einer neuen Batterie besteht Explosionsgefahr. Die Batterie darf nur durch denselben oder einen entsprechenden, vom Hersteller empfohlenen Batterietyp ersetzt werden. Entsorgen Sie verbrauchte Batterien den Anweisungen des Herstellers entsprechend.*



### **AVVERTIMENTO**

*Esiste il pericolo di un esplosione se la pila non viene sostituita in modo corretto. Utilizzare solo pile uguali o di tipo equivalente a quelle consigliate dal produttore. Per disfarsi delle pile usate, seguire le istruzioni del produttore.*



### PRECAUCIÓN

*Existe peligro de explosión si la pila no se cambia de forma adecuada. Utilice solamente pilas iguales o del mismo tipo que las recomendadas por el fabricante del equipo. Para deshacerse de las pilas usadas, siga igualmente las instrucciones del fabricante.*



### WAARSCHUWING

*Er bestaat ontploffingsgevaar als de batterij wordt vervangen door een onjuist type batterij. Batterijen moeten zoveel mogelijk worden gerecycled. Houd u bij het weggoaien van gebruikte batterijen aan de plaatselijke milieuwetgeving.*



### ATENÇÃO

*Haverá risco de explosão se a bateria for substituída por um tipo de bateria incorreto. As baterias devem ser recicladas nos locais apropriados. A eliminação de baterias usadas deve ser feita de acordo com as regulamentações ambientais da região.*



### AŠCIAROŽZNAŚĆ

*Існуе рызыка выбуху, калі заменены акумулятар неправильнага тыпу. Акумулятары павінны, па магчымасці, перепрацоўвацца. Пазбаўляцца ад старых акумулятараў патрэбна згодна з мясцовым заканадаўствам па экалогіі.*



### UPOZORNĚNÍ

*V případě výměny baterie za nesprávný druh může dojít k výbuchu. Je-li to možné, baterie by měly být recyklovány. Baterie je třeba zlikvidovat v souladu s místními předpisy o životním prostředí.*



### Προσοχή

*Υπάρχει κίνδυνος για έκρηξη σε περίπτωση που η μπαταρία αντικατασταθεί από μία λανθασμένου τύπου. Οι μπαταρίες θα πρέπει να ανακυκλώνονται όταν κάτι τέτοιο είναι δυνατό. Η απόρριψη των χρησιμοποιημένων μπαταριών πρέπει να γίνεται σύμφωνα με τους κατά τόπο περιβαλλοντικούς κανονισμούς.*



### VIGYAZAT

*Ha a telepet nem a megfelelő típusú telepre cseréli, az felrobbanhat. A telepeket lehetőség szerint újra kell hasznosítani. A használt telepeket a helyi környezetvédelmi előírásoknak megfelelően kell kiselejtezni.*



### 注意

異なる種類の電池を使用すると、爆発の危険があります。リサイクルが可能な地域であれば、電池をリサイクルしてください。使用後の電池を破棄する際には、地域の環境規制に従ってください。



### **AWAS**

*Risiko letupan wujud jika bateri digantikan dengan jenis yang tidak betul. Bateri sepatutnya dikitar semula jika boleh. Pelupusan bateri terpakai mestilah mematuhi peraturan alam sekitar tempatan.*



### **OSTRZEŻENIE**

*Istnieje niebezpieczeństwo wybuchu w przypadku zastosowania niewłaściwego typu baterii. Zużyte baterie należy w miarę możliwości utylizować zgodnie z odpowiednimi przepisami ochrony środowiska.*



### **PRECAUȚIE**

*Risc de explozie, dacă bateria este înlocuită cu un tip de baterie necorespunzător. Bateriile trebuie reciclate, dacă este posibil. Depozitarea bateriilor uzate trebuie să respecte reglementările locale privind protecția mediului.*



### **ВНИМАНИЕ**

*При использовании батареи несоответствующего типа существует риск ее взрыва. Батареи должны быть утилизированы по возможности. Утилизация батарей должна проводиться по правилам, соответствующим местным требованиям.*



### **UPOZORNENIE**

*Ak batériu vymeníte za nesprávny typ, hrozí nebezpečenstvo jej výbuchu. Batérie by sa mali podľa možnosti vždy recyklovať. Likvidácia použitých batérií sa musí vykonávať v súlade s miestnymi predpismi na ochranu životného prostredia.*



### **POZOR**

*Zamenjava baterije z baterijo drugačnega tipa lahko povzroči eksplozijo. Če je mogoče, baterije reciklirajte. Rabljene baterije zavržite v skladu z lokalnimi okoljevarstvenimi predpisi.*



### **คำเตือน**

*ระวังการระเบิดที่เกิดจากเปลี่ยนแบตเตอรี่ผิดประเภท หากเป็นไปได้ ควรนำแบตเตอรี่ไปรีไซเคิล การทิ้งแบตเตอรี่ใช้แล้วต้องเป็นไปตามกฎข้อบังคับด้านสิ่งแวดล้อมของท้องถิ่น.*



### **UYARI**

*Yanlış türde pil takıldığında patlama riski vardır. Piller mümkün olduğunda geri dönüştürülmelidir. Kullanılmış piller, yerel çevre yasalarına uygun olarak atılmalıdır.*



### **ОСТОРОГА**

*Використовуйте батареї правильного типу, інакше існуватиме ризик вибуху. Якщо можливо, використані батареї слід утилізувати. Утилізація використаних батарей має бути виконана згідно місцевих норм, що регулюють охорону довкілля.*



### UPOZORNĚNÍ

*V případě výměny baterie za nesprávný druh může dojít k výbuchu. Je-li to možné, baterie by měly být recyklovány. Baterie je třeba zlikvidovat v souladu s místními předpisy o životním prostředí.*



### ETTEVAATUST

*Kui patarei asendatakse uue ebasobivat tüüpi patareiga, võib tekkida plahvatusoht. Tühjad patareid tuleb võimaluse korral viia vastavasse kogumispunkti. Tühjade patareide äraviskamisel tuleb järgida kohalikke keskkonnakaitse alaseid reegleid.*



### FIGYELMEZTETÉS

*Ha az elemet nem a megfelelő típusúra cseréli, felrobbanhat. Az elemeket lehetőség szerint újra kell hasznosítani. A használt elemeket a helyi környezetvédelmi előírásoknak megfelelően kell kiselejtezni.*



### UZMANĪBU

*Pastāv eksplozijas risks, ja baterijas tiek nomainītas ar nepareiza veida baterijām. Ja iespējams, baterijas vajadzētu nodot attiecīgos pieņemšanas punktus. Bateriju izmešanai atkritumos jānotiek saskaņā ar vietējiem vides aizsardzības noteikumiem.*



### DĒMESIO

*Naudojant netinkamo tipo baterijas įrenginys gali sprogti. Kai tik įmanoma, baterijas reikia naudoti pakartotinai. Panaudotas baterijas išmesti būtina pagal vietinius aplinkos apsaugos nuostatus.*



### ATTENZJONI

*Riskju ta' splużjoni jekk il-batterija tinbidel b'tip ta' batterija mhux korrett. Il-batteriji għandhom jiġu riċiklati fejn hu possibbli. Ir-rimi ta' batteriji użati għandu jsir skond ir-regolamenti ambjentali lokali.*



### OSTRZEŻENIE

*Ryzyko wybuchu w przypadku wymiany na baterie niewłaściwego typu. W miarę możliwości baterie należy poddać recyklingowi. Zużytych baterii należy pozbywać się zgodnie z lokalnie obowiązującymi przepisami w zakresie ochrony środowiska.*