

WHITE PAPER

Database Application Performance and Characterization Series

Publication Date

June 1998

Compaq
Database Technology
and Solutions Center

CONTENTS

NOTICE.....	2
INTRODUCTION.....	3
WORKFLOW APPLICATION ENVIRONMENT.....	4
VIEWSTAR APPLICATION ARCHITECTURE.....	6
Workflow Services.....	7
Data Services.....	7
File Services.....	7
Storage Devices.....	7
Enterprise Server.....	7
Oracle Configuration.....	7
TEST APPROACH.....	8
TEST RESULTS.....	11
Phase 1 Tests.....	11
Phase 1 Test Result.....	11
Analysis of Phase 1 Test Results.....	14
Phase 2 Tests.....	15
Phase 2 Test Result.....	15
Analysis of Phase 2 Test Results.....	18
RECOMMENDATIONS.....	19
Workflow Application Tuning	
SQL Select and Commit Statements.....	19
User Connect and Disconnect.....	19
Queuing Process.....	20
Use Of Stored Procedures.....	20
CONCLUSIONS.....	21

Tuning Enterprise Workflow Applications on ProLiant Servers

Customer Application Case Study with Oracle/ViewStar on Microsoft Windows NT

*Compaq's Database Technology and Solutions Center (DTSC) has commissioned the **Application Performance and Characterization White Paper Series** to investigate techniques and practices designed to improve the performance of enterprise applications running on Compaq ProLiant Servers with Oracle RDBMS on Microsoft Windows NT.*

This case study jointly performed by Compaq and Oracle explores the performance characteristics of a real world application on Compaq ProLiant servers. The testing was performed at the Compaq/Oracle International Competency Center (ICC), located within the Compaq DTSC in San Bruno, California. The Compaq/Oracle ICC was established to address Oracle database related issues such as solution development and validation, advanced technology, customer case studies and proof of concept projects.

The study involved evaluating and optimizing an enterprise class application based on Mosaix's¹ ViewStar workflow application framework. This White Paper details the techniques and practices used to improve the performance of the customer's workflow application running Oracle's Enterprise Server on Windows NT. The results of the tests performed indicate that:

- Identifying and correcting poorly tuned transactions significantly improved application responsiveness.
- Tuning the ViewStar Application components within the production environment reduced the application transaction throughput time.
- Modifying the RAID configuration of the server's disk sub-system improved the I/O throughput and overall application performance.
- Partitioning the data and index files on the physical disks, improved the overall database performance

NOTICE

The information in this publication is subject to change without notice.

COMPAQ COMPUTER CORPORATION SHALL NOT BE LIABLE FOR TECHNICAL OR EDITORIAL ERRORS OR OMISSIONS CONTAINED HEREIN, NOR FOR INCIDENTAL OR CONSEQUENTIAL DAMAGES RESULTING FROM THE FURNISHING, PERFORMANCE, OR USE OF THIS MATERIAL.

This publication does not constitute an endorsement of the product or products that were tested. The configuration or configurations tested or described may or may not be the only available solution. This test is not a determination of product quality or correctness, nor does it ensure compliance with any federal, state or local requirements. Compaq does not warrant products other than its own strictly as stated in Compaq product warranties.

Product names mentioned herein may be trademarks and/or registered trademarks of their respective companies.

Compaq, Compaq Insight Manager, ProLiant, SmartStart, NetFlex, registered United States Patent and Trademark Office.

Netelligent is a trademark and/or service mark of Compaq Computer Corporation.

Other product names mentioned herein may be trademarks and/or registered trademarks of their respective companies.

©1998 Compaq Computer Corporation

Printed in the U.S.A.

Microsoft, Windows, Windows NT, Windows NT Advanced Server, SQL Server for Windows NT are trademarks and/or registered trademarks of Microsoft Corporation.

ORACLE CORPORATION

Oracle Consulting Services

Compaq Products Division

COMPAQ COMPUTER CORPORATION

Enterprise Solutions Division

Database Technology and Solutions Center

Compaq/Oracle Enterprise Solutions Lab

All rights reserved. Printed in the USA

INTRODUCTION

The workflow application was a project developed and managed by the customer's internal IT Division. The customer's workflow application consists of components from a number of system and software vendors:

- Oracle database software
- Compaq ProLiant servers
- ViewStar workflow application software
- Microsoft Windows NT operating system
- Microsoft Visual Basic software

In order to analyze the performance characteristics of the customer's application, the application software and sample database files were installed at the Compaq/Oracle International Competency Center (ICC). Test results of the customer's production system revealed that the application response time was much higher than expected. This prompted further study of the customer's environment to identify possible performance bottlenecks.

To establish a performance baseline for the customer's application, the test environment was configured exactly the same as the customer's production system. To accurately simulate the customer's production environment, a log routine was run on one of the process agents at the customer site. The routine was run for a period of 24 hours and a copy of all the SQL transactions processed by that agent was recorded and saved to an ASCII file. The SQL transaction log file was used as a sample of workflow application.

After the baseline testing was completed, a series of system upgrades, application transaction changes and database modifications were made to determine the impact on the application's performance and throughput.

The tests began with 30 users and increased to over 150 end users over time. The underlying hardware was then upgraded to include a second P166 MHz processor with an additional 256MB of memory to accommodate the additional users.

WORKFLOW APPLICATION ENVIRONMENT

Figure 1 illustrates the workflow application hardware environment. The ViewStar Application server and Oracle database server were configured to simulate the customer's production environment. The systems used for Scanning and Fax were not configured and only one client and ViewStar process machine were used during the testing.

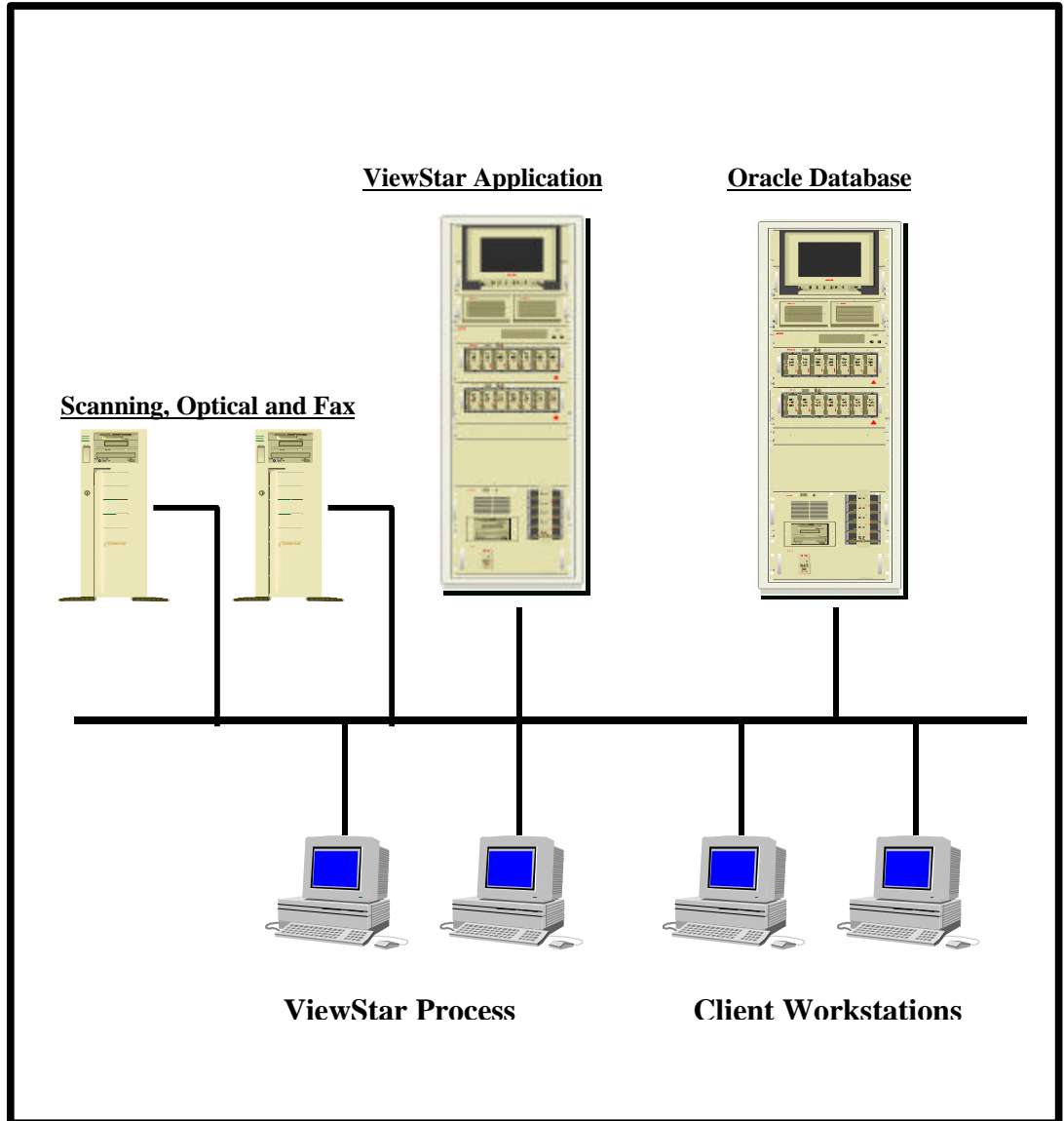

Figure 1 – Workflow Application Environment

The systems used during the testing consisted of the following hardware components. Test environment consisted of a ProLiant 2500 which served as the Client system, a ProLiant 4500 which served as the ViewStar Application Server and Backup Domain Controller, ProLiant 5000 which served as the Oracle database server, and ProLiant 2000 that served as the database performance monitor and Primary Domain Controller.

SYSTEM	CPU	SYSTEM MEMORY	NETWORK	SOFTWARE
ProLiant 2500	1 200MHz Pentium Pro Processor	1GB System Memory	10 base-T Network Card	Windows NT Server 4.0 w/SP3

Table 1 – Client System Configuration

SYSTEM	CPU	SYSTEM MEMORY	NETWORK	SOFTWARE
ProLiant 4500	1 100MHz Pentium Processor	256MB System Memory	10 base-T Network Card	Windows NT Server 4.0 w/SP3

Table 2 – Backup Domain Controller Server Configuration

SYSTEM	CPU	SYSTEM MEMORY	NETWORK	SOFTWARE
ProLiant 5000	2 200MHz Pentium Pro Processor	512GB System Memory 1 Compaq Smart 2/P Array Controllers	10 base-T Network Card	Windows NT Server 4.0 w/SP3

Table 3 – Oracle Database Server Configuration

SYSTEM	CPU	SYSTEM MEMORY	NETWORK	SOFTWARE
ProLiant 2000	1 100MHz Pentium Processor	128MB System Memory	10 base-T Network Card	Windows NT Server 4.0 w/SP3

Table 4 – Server Configuration for Oracle Performance Monitor

VIEWSTAR APPLICATION ARCHITECTURE

The ViewStar workflow software combines business rules and procedures with document information to manage the flow of work throughout the enterprise. The *ViewStar* system is an open, network solution that automates and manages business processes.

Workflow is the automated flow of work, documents and related information through the business process. Workflow comprises aggregating and consolidating information from diverse sources and routing it to the people who need it to accomplish their work.

ViewStar's development environment can be used to define the work content, business rules, workflow maps, and user roles and activities. A library of predefined business functions and reusable tasks can be employed to create workflow maps that represent the business process.

The customer implemented the ViewStar workflow application to manage the documents generated as part of the customer's forms processing system. All forms submitted by applicants are scanned into binary files and stored into a virtual folder. Information on each applicant is assigned a virtual folder, which contains pertinent data submitted by the applicant. All letters, mortgage forms, and insurance forms to be processed are scanned into binary formats and stored within the workflow repository. All other information required to be linked with individual binary files to each other and customers are stored and updated within the Oracle (7.3.3) database. Alteration to any of the documents are also archived and stored within the database. **Figure 2** illustrates a typical Forms Processing Workflow Architecture.

The workflow application architecture as illustrated in Figure 2, is designed to support a number of systems working cooperatively to serve the needs of the enterprise. This application provides a set of services, and delivers comprehensive functionality and benefits for systems deployment.

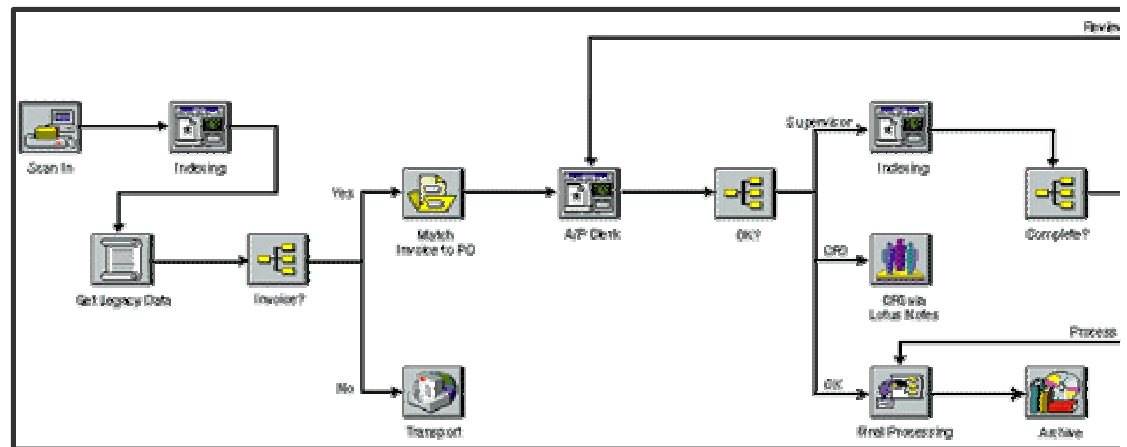

Figure 2 – Typical Workflow Application Architecture

Workflow Services

Workflow services provide configurable and programmable automated task processing. It executes either actively generated tasks during the workflow, such as printing, or pre-scheduled tasks to be run periodically at pre-determined times or at specific events.

Data Services

Information associated with work documents such as location is managed by ViewStar's data services. The information can be contained in the workflow system or in the document repository.

File Services

The file services provide online storage and object data. All objects or unstructured data associated with documents, folders and work packets involved in workflow applications are stored and managed by ViewStar's file services.

Storage Devices

The storage devices provide archived document storage on optical devices. These services control the writing of files to optical jukeboxes and platters for long-term archival storage.

Enterprise Server

The enterprise server provides enterprise-wide workflow, including document and data distribution. Wide-area, multi-site workflows are linked by Microsoft MAPI messaging and replication services using ViewStar's enterprise server. The enterprise server moves centralized resources to the database and enables the distribution of work geographically for local processing with local data.

Only one ViewStar process agent was configured in our test, this was done to simplify the test environment. In addition, the process of collecting the data generated from the test and performing data analysis was simplified.

A log routine was initiated against one of the process agents set up at the customer site. The contents of all the activities carried out by the agent were spooled to an ASCII log file. The routine was run for a period of 24 hours and a copy of all the SQL transactions processed by that agent was recorded and saved to the file. This SQL transaction log file was used as a sample of the customer's application workload.

Oracle Configuration

A ProLiant 5000 running Microsoft Windows NT and Oracle RDBMS v7.3.3 was used as the database server. Oracle Enterprise Manager Performance Pack was also installed on the main PDC (Windows NT Primary Domain Controller) machine. The database monitoring tools in the Performance Pack were used to monitor the Oracle database during system and the application load.

TEST APPROACH

The main objective of the tests were:

- Evaluate the database software implementation and make suitable recommendations based on key findings.
- Evaluate the Compaq hardware used to host the Oracle database and make suitable recommendations based upon the findings.
- Make firm recommendations on the main areas of resource contention that affect the overall system performance and response time.
- Evaluate the physical database layout as well as the underlying I/O subsystem. Make recommendations on the most suitable configuration.

The test was executed in two phases. In addition to the Phase 1 and Phase 2, Oracle and Windows NT performance monitoring tools and techniques were used to identify key performance bottlenecks. Based on these findings, modifications were made to the Oracle database and the ViewStar application environment to improve the overall performance. A description of Phase 1 and Phase 2 are described below:

- PHASE 1
 - The primary goal Phase 1 was to obtain an accurate set of baseline statistics on the system usage and it's underlying database and application. A database was created identical to the database in use at the customer's site. The data files, control files and the redo log files were all created as indicated by the customer. Mixed queries were run against the database to establish a set of baseline performance metrics.
- PHASE 2
 - Server hardware modifications, system disk configuration and the database layout were modified based on the findings in Phase 1. These modifications resulted in dramatic improvements to the overall application performance, utilization and transaction throughput.

WHITE PAPER *(cont.)*

The tables below detail the Phase 1 initial configuration of the database server used for baseline testing and the system modifications used during Phase 2.

SYSTEM	CPU	SYSTEM MEMORY	NETWORK	SOFTWARE
ProLiant 5000	1 200MHz Pentium Pro Processor	256MB System Memory 1 Compaq Smart 2/P Array Controllers	10 base-T Network Card	Windows NT Server 4.0 w/SP3

Table 5 – Phase 1 Oracle Server System Configuration

SYSTEM	CPU	SYSTEM MEMORY	NETWORK	SOFTWARE
ProLiant 5000	2 200MHz Pentium Pro Processor	512MB System Memory 1 Compaq Smart 2/P Array Controllers	10 base-T Network Card	Windows NT Server 4.0 w/SP3

Table 6 – Phase 2 Oracle Server System Configuration

Test Case Description

A total of five test cases were used during Phase 1 and Phase 2. Each test executed the test script containing sample transactions extracted from the original customer environment. There was one user - MIS_OWNER, issuing a complex and long running query against the database as one of the test requirements in the customer environment. The initial results from Test 1, Test 2, and Test 3 indicated an excessive amount of full table scans. In order to reduce the number of full table scans, it was necessary to create indexes on selected tables for Test 4 and Test 5.

Below is a brief description of the tests used during Phase 1 and Phase 2:

- Test 1
 - Execute the pre-defined test script 50 times with the MIS_OWNER account issuing the query.
- Test 2
 - Execute the pre-defined test script 100 times with the MIS_OWNER account issuing the query.
- Test 3
 - Disconnect all users except MIS_OWNER. The MIS_OWNER account is the only user issuing the long running complex query.
- Test 4
 - Execute the pre-defined test case 50 times against the database after the indexes were created. The MIS_OWNER was disconnected.
- Test 5
 - Execute the pre-defined test case 100 times against the database after the indexes were created. The MIS_OWNER was disconnected.

Before every test, the Oracle utility Bstat/Estat was used to collect database performance statistics. Bstat clears all previous statistics from Oracle dictionary tables; Estat converts the collected statistics into a readable form that can be accessed through a standard word processor.

TEST RESULTS

Phase 1 Tests

The primary objective of the tests in Phase 1 was to obtain an accurate set of system utilization statistics using the customer's original (production) application and its underlying database.

A database was created on the main database server identical to the production database used at the customer site. The data files, control files and the redo log files were created in the similar directories as well. The system configuration is described below:

- 1 200 MHz Pentium Pro Processor
- 256MB RAM
- RAID-0 for operating system drives
- RAID-5 for all database files

The data files were placed onto a logical volume made up of several physical disks and configured as a RAID-5 (Redundant Array of Independent Disks) disk set. The indexes created for Test 4 and Test 5 also used RAID-5 disk set.

Phase 1 Test Result

Table 7 lists the statistics being collected and the corresponding figure name of the result during phase 1 test. The same statistics will be collected in phase 2 test.

FIGURE NAME	TEST DESCRIPTION
Figure 3:PHASE 1 – A	CPU Utilization of Tests 1 – 5
Figure 4:PHASE 1 – B	Elapsed time of Tests 1 – 5
Figure 5:PHASE 1 – C	Physical Reads of Tests 1 – 5
Figure 6:PHASE 1 – D	Physical Writes of Tests 1 – 5
Figure 7:PHASE 1 – E	Total Number of Rows Scanned for Test 1 – 5

Table 7 – Test Descriptions

PHASE 1-A CPU UTILIZATION

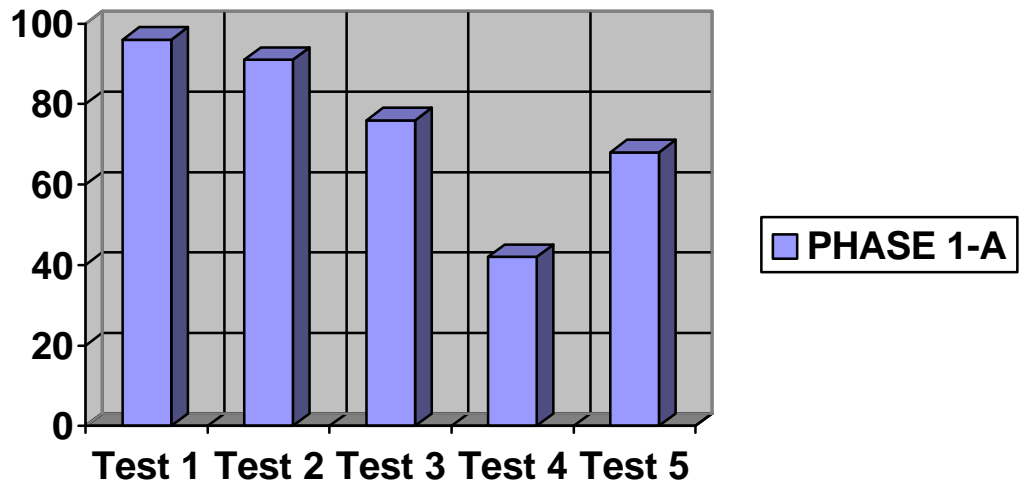

Figure 3 - Phase 1 - A Test Results

PHASE 1-B ELAPSED TIME (Minutes)

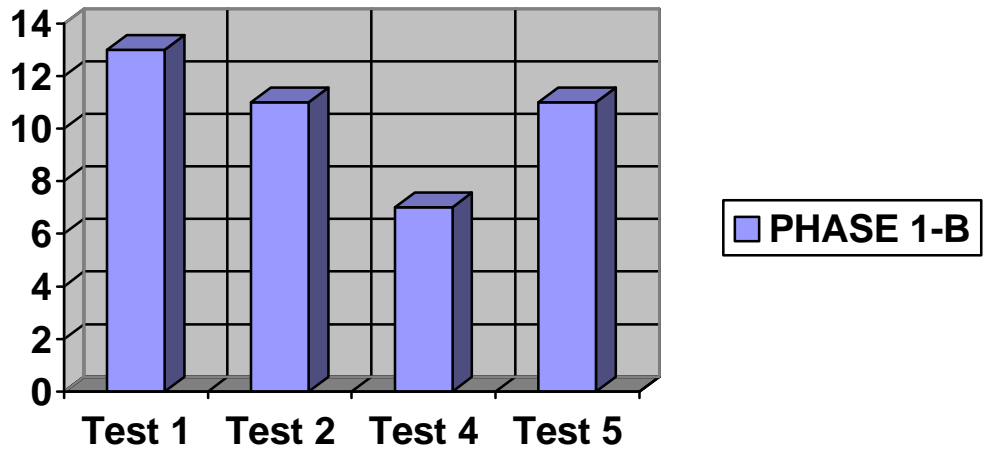

Figure 4 - Phase 1 - B Test Results

PHASE 1-C PHYSICAL READS

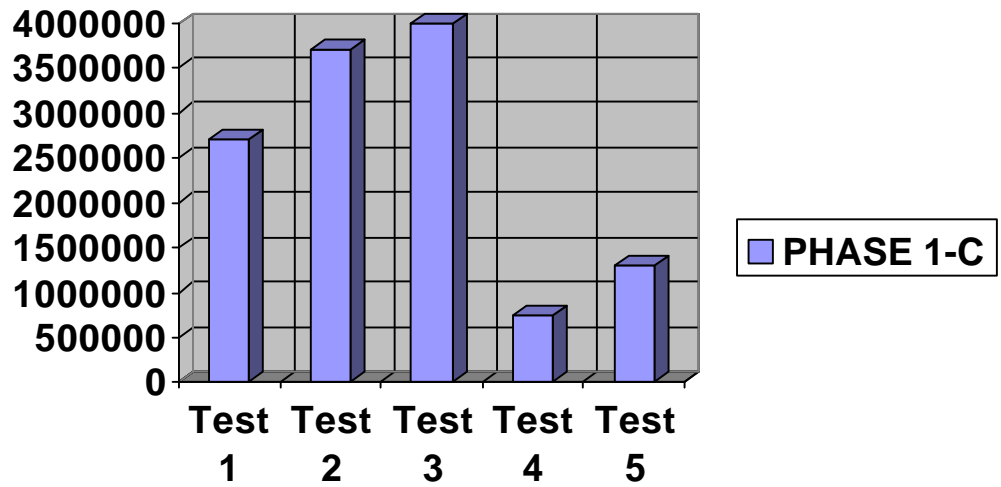

Figure 5 - Phase 1 - C Test Results

PHASE 1-D PHYSICAL WRITES

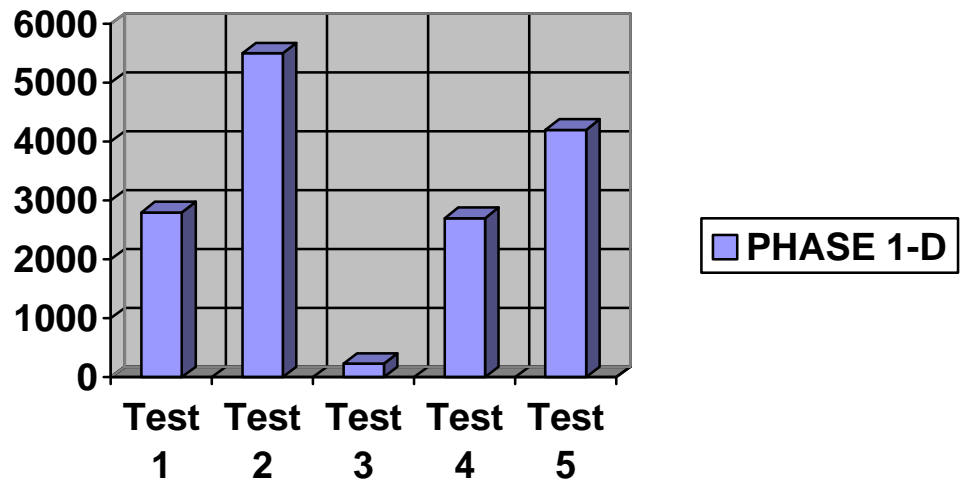

Figure 6 - Phase 1 - D Test Results

PHASE 1-E ROW SCANNED (Millions)

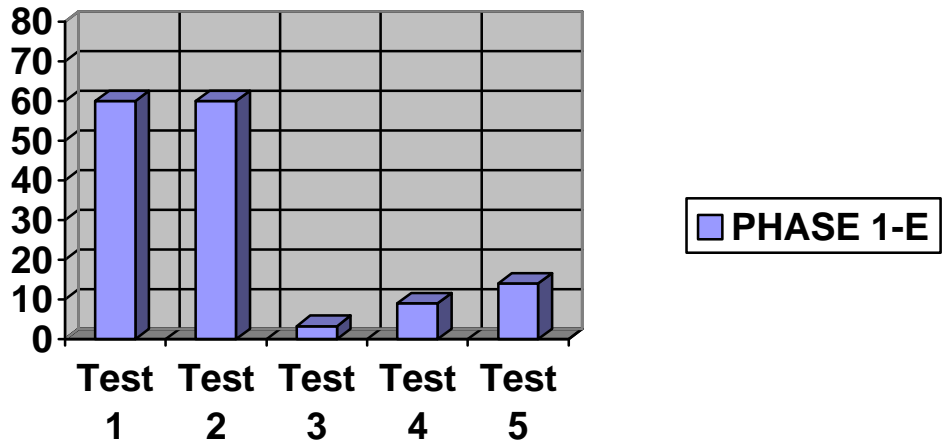

Figure 7 - Phase 1 - E Test Results

Analysis of Phase 1 Test Results

The main observation from the tests in this phase were:

- A large number of table scans (sequential reads) were observed – typically this is abnormal for OLTP type applications.
- Figure 7, phase 1–E, illustrated a high number of rows scanned in Test 1 and 2. This resulted in a high number of physical reads (Figure 5, Phase 1-C) and physical writes (Figure 6, Phase 1 – D).
- After creating indexes for selected tables, the number of rows scanned was reduced significantly in Tests 4, and 5 (Figure 7, Phase 1-E). Physical writes were reduced in Test 5 as well.
- By decreasing the number of rows scanned, better overall disk I/O throughput was achieved.

Phase 2 Tests

The primary objective of the tests in Phase 2 was to compare the performance and transaction throughput of the customer’s application after making the following changes to the test environment.

- Operating system files and Oracle RDBMS server engine were placed on one drive with RAID-0
- The Redo Log files were placed on another drive with RAID-0 to minimize the I/O for the test. The Redo file should never be on RAID-0 in the customer environment.
- All database tables and indexes were distributed to the rest of the drives with RAID-1
- The database server box was changed from one CPU to two CPUs
- The system memory on the database server was expanded from 256MB to 2GB

Phase 1 test environment was completely removed to make a clean build for phase 2 test environment. The system configuration was rebuilt including the operating system and Oracle software and database files were recreated.

Phase 2 Test Result

Table 8 lists the statistics being collected and the corresponding figure name of the result during phase 2 test. Each figure also includes the corresponding result from phase 1 for comparisons.

TEST NAME	TEST DESCRIPTION
Figure 8:PHASE 2 – A	CPU Utilization of Tests 1 - 5
Figure 9:PHASE 2 – B	Elapsed time of Tests 1 – 5
Figure 10:PHASE 2 – C	Physical Reads of Tests 1 – 5
Figure 11:PHASE 2 – D	Physical Writes of Tests 1 – 5

Table 8 – Phase 2 Test Descriptions

PHASE 2-A CPU UTILIZATION

Phase 1 vs. Phase 2

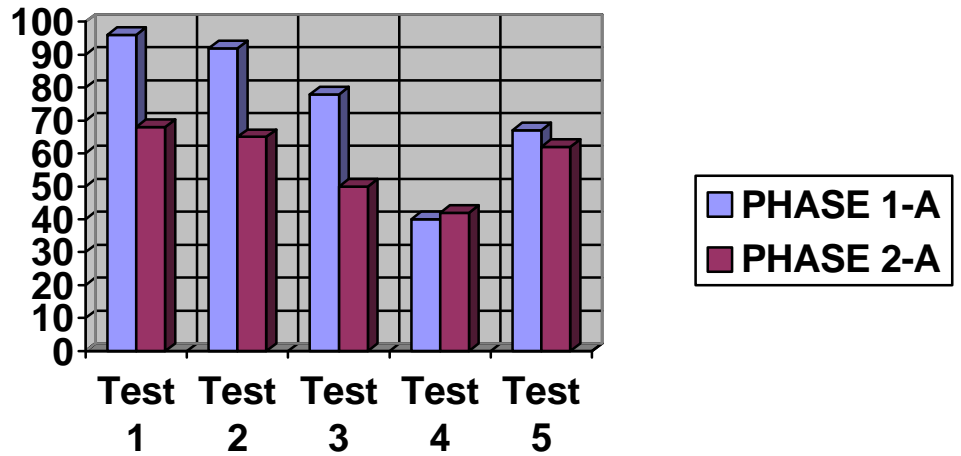

Figure 8 - Phase 2 - A Test Results

PHASE 2-B ELAPSED TIME

Phase 1 vs. Phase 2
(Minutes)

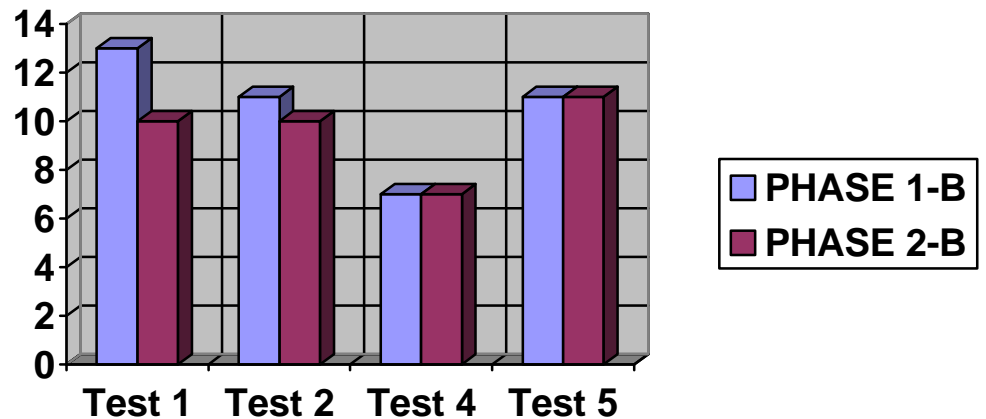

Figure 9 - Phase 2 - B Test Results

PHASE 2-C PHYSICAL READS

Phase 1 vs. Phase 2

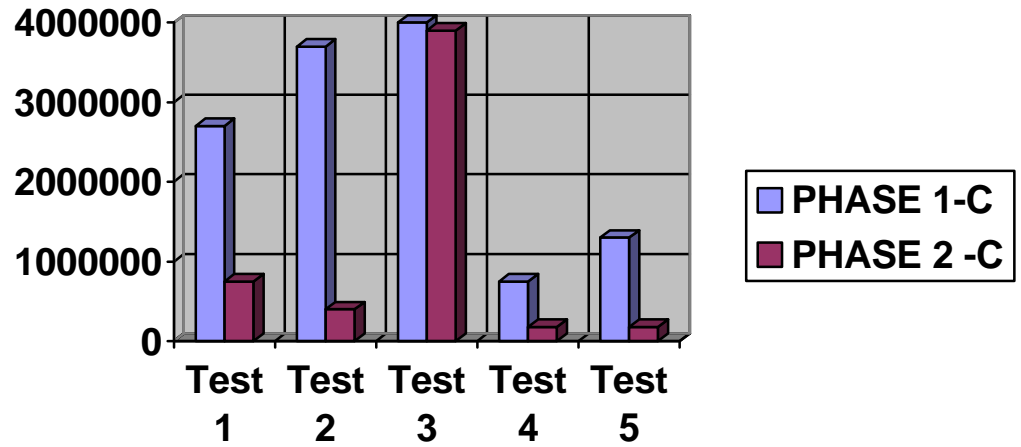

Figure 10 - Phase 2 - C Test Results

PHASE 2-D PHYSICAL WRITES

Phase 1 vs. Phase 2

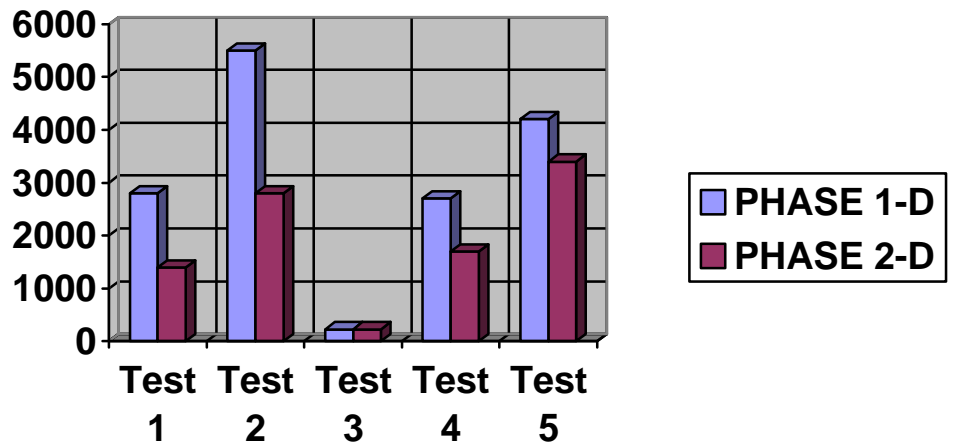

Figure 11 - Phase 2 - D Test Results

Analysis of Phase 2 Test Results

The main observation from the tests performed in this phase showed that:

- Phase 2-C and Phase 2-D (Figure 10,11) shows improvement in both physical read and writes. This was accomplished by moving the Oracle database files from RAID-5 to a RAID-1 disk set.
- The test results indicate that the tests in Phase 2 were still showing a significant number of table scans, the number of rows scanned were not dramatically reduced. Performance related database improvements can be made by creating indexes on heavily used tables.
- Additional evaluation of the application is necessary to determine the reason for its high reads, and CPU utilization. However, the scope of this case study did not allow for extensive testing to identify the potential causes.
- There was benefit gained by adding the second processor and additional memory to the database server. Additional test cases are needed to quantify the effect of upgrading the hardware.

RECOMMENDATIONS

Workflow Application Tuning

After careful analysis of the overall test environment, we found one additional areas, the Workflow application, can be enhanced. The Windows NT Performance Monitor report from the test indicated an alarming amount of reads on several Oracle data files. The Oracle statistic report shows excessive connect/disconnect and significant number of COMMIT statements issued in the application. We analyzed the application and made the following recommendations.

- Reduce COMMIT statement
- Eliminate excessive connect/disconnect in application
- Improve the queuing process within the workflow environment
- Use of stored procedures
- Improve database table access by establishing public synonyms with proper privileges for users during logon/logoff process

SQL Select and Commit Statements

The ViewStar workflow transaction SQL script contained a large number of unnecessary commit statements. Analysis of the application revealed the following performance related issues:

- A significant number of COMMIT statements issued after a SELECT statement.
- Multiple COMMIT statements issued one after another for no apparent reason.

The main test script was modified to use a single COMMIT statement at the end of the transaction. This significantly reduced the number of redundant COMMIT statements used for each transaction.

User Connect and Disconnect

In the existing workflow environment, a user is required to log into each individual scheme to access the data (tables) in that scheme. The customer's workflow application contained a large number of unnecessary connect/disconnect statements. There is a noticeable overhead involved with this process. The SQL script was modified to use a single connect statement at the start of the transaction and a single disconnect statement at the end.

In order to insure proper workflow processing, unique global names (Oracle synonyms) were used along with grant access to tables within a scheme. This would allow a user connected as USER1 to access tables without logging off and log back on as a different user. To make tables to all schemes (user accounts) accessible, Oracle public synonyms were created and the required privileges were granted to enable global access by all user accounts.

TRANSACTIONS	TIME
A single run with multiple Connects/Disconnects	9 Mins
100 runs with Multiple Connects/ Disconnects	10 Mins
A single run with modified One Connect/ Disconnect	3 Mins
100 runs with modified One Connect / Disconnect	4 Mins

Table 9: Results of Application tuning

ECG096/0698

Queuing Process

The customer's workflow environment uses a number of processing queues to move records through the system. This queuing technique was designed to segment the record processing workflow. The main advantage of this approach is to insure that records are protected as they are processed through each queue. The figure below illustrates the system queue process:

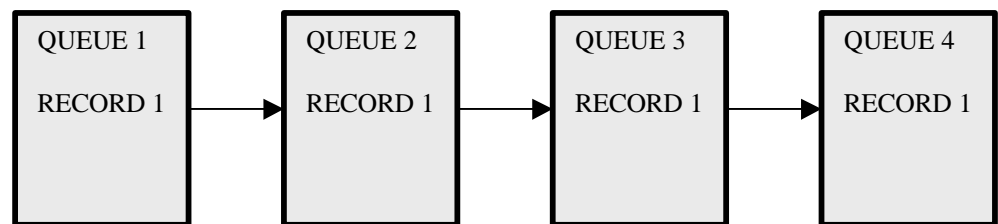

Figure 12 – Application Workflow Queuing Process

As record 1 is moved from one queue to another, it is updated to reflect the work performed in each queue. This requires that the record in Queue 1 is selected and then deleted when inserted into Queue 2. This technique requires at least three disk I/O's to be performed for every record processed through the workflow system.

After analyzing the performance impact of this approach, a status column was added to the database table to eliminate the need to delete and re-insert records into the queue. By adding the status column, each record could be updated to indicate the status in the workflow. This resulted in only a single disk I/O for each record processed through the workflow system. This modification to the system resulted in a significant improvement to the overall performance of the customer's application. The single queue approach provided a shorter elapsed time than the multiple queue approach.

Use Of Stored Procedures

It was recommended that the customer investigate the feasibility of using Oracle Stored Procedures. Stored Procedures are SQL statements written, compiled and stored within the Oracle Enterprise Database Server. It is one of the most efficient ways to use Oracle's functionality in a Client/Server OLTP environment. Using stored procedures will significantly reduce the amount of data sent from the client to the Oracle Database Server.

CONCLUSIONS

- Establishing a multi-phased approach to characterizing the application and its underlying components (database, O/S, and hardware) is critical to successfully identifying performance bottlenecks.
- Using both Oracle and Windows NT supplied tools and utilities and implementing a systematic approach to performance analysis, it is possible to identify key performance problems and improve the application performance.
- A detailed knowledge of the application, underlying database, O/S environment and hardware configuration is essential to understanding what modifications should be made to the application environment.
- Establishing performance baselines and making controlled modifications to key areas, followed by measuring resultant performance impact is the most efficient method to improve application performance and scalability.
- Although the customer's initial assumption suggested the Compaq ProLiant Server might not be well suited to meet the requirements for the workflow application. The system and workflow application modifications identified in this case study prove that a ProLiant server is well suited for running this type of mission critical complex application.