



Lotus Domino Server 4.51 Service Failover Using Microsoft Cluster Server

TechNote

**First Edition (March 1998)
Part Number 298220-001
Compaq Computer Corporation**

Notice

The information in this publication is subject to change without notice.

COMPAQ COMPUTER CORPORATION SHALL NOT BE LIABLE FOR TECHNICAL OR EDITORIAL ERRORS OR OMISSIONS CONTAINED HEREIN, NOR FOR INCIDENTAL OR CONSEQUENTIAL DAMAGES RESULTING FROM THE FURNISHING, PERFORMANCE, OR USE OF THIS MATERIAL. THIS INFORMATION IS PROVIDED "AS IS" AND COMPAQ COMPUTER CORPORATION DISCLAIMS ANY WARRANTIES, EXPRESS, IMPLIED OR STATUTORY AND EXPRESSLY DISCLAIMS THE IMPLIED WARRANTIES OF MERCHANTABILITY, FITNESS FOR PARTICULAR PURPOSE, GOOD TITLE AND AGAINST INFRINGEMENT.

This publication contains information protected by copyright. No part of this publication may be photocopied or reproduced in any form without prior written consent from Compaq Computer Corporation.

© 1998 Compaq Computer Corporation.
All rights reserved. Printed in the U.S.A.

The software described in this guide is furnished under a license agreement or nondisclosure agreement. The software may be used or copied only in accordance with the terms of the agreement.

Compaq, Deskpro, ProLiant, ROMPaq, SmartStart, registered United States Patent and Trademark Office.

Netelligent is a trademark and/or service mark of Compaq Computer Corporation.

Microsoft, MS-DOS, Windows, and Windows NT are registered trademarks of Microsoft Corporation.

Other product names mentioned herein may be trademarks and/or registered trademarks of their respective companies.

Lotus Domino Server 4.51 Service Failover Using Microsoft Cluster Server

First Edition (March 1998)
Part Number 298220-001

Contents

Chapter 1

About This TechNote

Introduction.....	1-1
Expected Audience	1-1
Text Conventions	1-2

Chapter 2

Overview of a Failover

Types of Failover	2-1
What are the Advantages of a Failover?	2-2
What are the Disadvantages of a Failover?.....	2-2

Chapter 3

Model Failover Environment

Model Environment Naming Conventions	3-3
Hardware Requirements.....	3-5
Server Configuration.....	3-5
Client Configuration	3-5
Software Requirements	3-6
Server Configuration.....	3-6
Client Configuration	3-6

Chapter 4

Software Installation Process

Microsoft Cluster Server Installation	4-1
Lotus Domino Server 4.51 Installation	4-2
Pre-installation tasks	4-2
Domino Server Installation	4-2
Domino Server Setup.....	4-6

Chapter 5

Configuration of Microsoft Cluster Server

Lotus Domino Resource Group	5-1
Dependencies	5-2
Creating the Lotus Domino Resources	5-2
Physical Disk	5-3
IP Address	5-3
Network Name	5-8
Generic Service	5-12
Starting the Domino Server Group	5-17
Tuning the Domino Server	5-19

Chapter 6

Lotus Notes Client Installation

Installing the Lotus Notes Client	6-1
Lotus Notes Setup	6-2

Chapter 7

Verifying the Failover

Appendix A

Hardware Configuration

Server 1	A-1
Server 2	A-2

Appendix B

Troubleshooting

Glossary

Index

Chapter 1

About This TechNote

Introduction

The purpose of this document is to provide a practical and effective way of implementing a successful Compaq ProLiant Cluster service failover for Lotus Domino Server 4.51.

Expected Audience

This document is intended to help in the installation, configuration and administration of Microsoft Cluster Server with Lotus Domino Server and assumes that the reader has working knowledge of the following:

- Installing and configuring Compaq Servers and Compaq ProLiant Cluster Servers
- Installing and configuring Microsoft Windows NT Server Enterprise
- Microsoft Windows NT Server interface and setting up and administering user accounts in a domain
- Installing and configuring Lotus Domino Server
- Installing, configuring, and administering Microsoft Cluster Server

Text Conventions

This document uses the following conventions to distinguish elements of text:

Table 1-1

Text Conventions

Convention	Use
OK, CANCEL	Window command button labels appear in bold caps.
CTRL + DEL	Keyboard keys appear in bold caps.
<i>c:\dirname\filename.exe</i>	Path Names of items such as files, directories, resources, groups, and services appear in bold italics.
Select Item → Item	Items you select from a pull down menu appear in bold initial caps, separated by arrows for each submenu item
<i>USER INPUT</i>	Information to be entered by the user is shown in uppercase italics

Chapter 2

Overview of a Failover

Types of Failover

In the first release of Microsoft Cluster Server, there are two types of failovers: service and resource. Both types of failovers allow for high levels of server and application availability.

In a service failover configuration, a service is defined to Microsoft Cluster Server as a resource. Once defined, its Failover Manager Process ensures that the service is running on only one member of the cluster at a given time. Although the service is running on only one member of the cluster at a time, the resource group where the service is defined uses a common name. Therefore, all services running on that resource group are available to all connected network client machines using the common name.

A more comprehensive model is the resource failover, which takes advantage of Independent Software Vendor's (ISV) cluster-aware resource DLLs to execute the failover. In a resource failover configuration, it is assumed that the service is running on both members of the cluster and that some resource such as a database or a website fails over, and not the service.

Since most ISV applications do not yet have resources to make them cluster-aware, service failovers are the most common forms of implementing the failover in Microsoft Cluster Server. Microsoft provides a generic service resource DLL to allow these applications to function under Microsoft Cluster Server.

What are the Advantages of a Failover?

Both service and resource failovers provide a highly available computing environment with relative simplicity and can be used for both planned and unplanned service outages. A planned outage occurs when one of the members in the cluster is taken offline for upgrades or maintenance. An unplanned outage occurs when one of the members or the application on that member fails. During both types of outages, the services and/or resources can be moved to the other member of the cluster. Since the clients do not communicate to the server directly but through a virtual server, the failover can be transparent to the clients.

Note: This depends on the mechanism that allows the client and the clusters to re-establish a live connection to continue the services. For example, developing client software that automatically re-establishes a connection after losing them provides near transparent failover.

What are the Disadvantages of a Failover?

One of the main disadvantages of a Microsoft Cluster Server Failover is that in a failover condition, the performance of the server taking over the work load of the failed server may degrade since it is now doing the work of both servers. However, by manually balancing the load and selecting the appropriate hardware, performance degradation can be minimized.

Another major disadvantage of a failover environment is that the state information of the application is not monitored. As a result, when the application fails over, an entire new instance of the application is started. Any work in progress is lost and data recovery must occur.

Chapter 3

Model Failover Environment

The model environment presented here consists of two Compaq ProLiant servers sharing a ProLiant Storage Unit and its drives, networked to each other through a LAN and a dedicated server interconnect.

In order to enhance availability, Compaq strongly recommends the use of at least two PCI network cards per server. One of these cards should be connected to its counterpart in the other node of the cluster via a private hub or a special crossover cable, such as the one supplied in the cluster kit. These cards should be configured for cluster communication only. The other card in each server should be configured for both client access and cluster communication. This configuration allows the client network to provide an alternative path for the heartbeat should the dedicated connection fail.

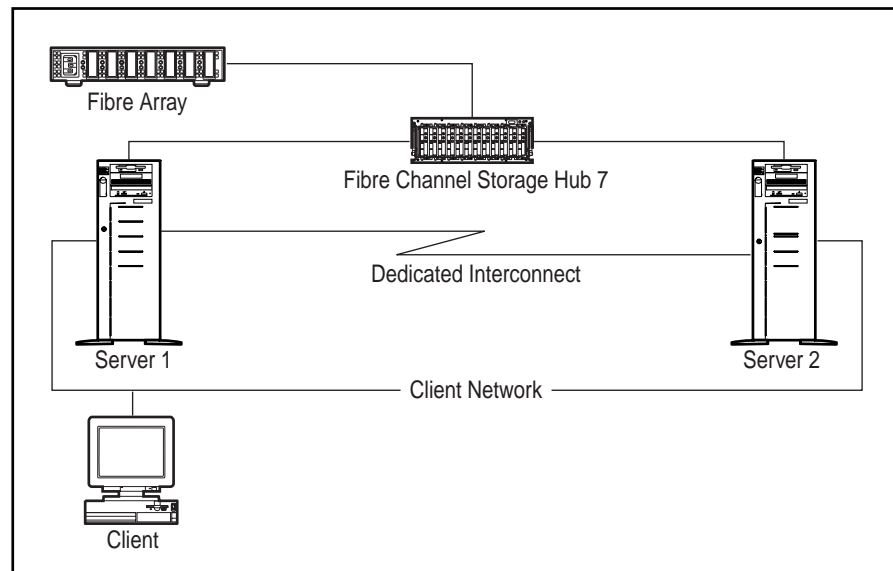

Figure 3-1. Standard ProLiant Cluster Configuration

3-2 *Model Failover Environment*

For even higher availability Compaq recommends the use of duplexed network cards configured for client access and cluster communication, in addition to using a dedicated connection as described above.

Note: In order to create a cluster, a Domain environment is required using TCP/IP as the network protocol. Both servers as a cluster should be configured to be servers in the domain. It is highly recommended that you do not use either server in a cluster as a Primary or Backup domain controller.

Model Environment Naming Conventions

Table 3-1
System and Cluster Specifics

Operating System	Windows Enterprise Server 4.0 w/ Service Pack 3
Domain Name	WPDOMAIN
Name of Server 1	NODE1
IP Address of Server 1	110.2.30.31 (subnet mask 255.255.0.0)
IP Address of Interconnect	110.4.30.31 (subnet mask 255.255.0.0)
Name of Server 2	NODE2
IP Address of Server 2	110.2.30.32 (subnet mask 255.255.0.0)
IP Address of Interconnect	110.4.30.32 (subnet mask 255.255.0.0)
Name of Cluster	WPCLUSTER
IP Address of Cluster	110.2.30.100 (subnet mask 255.255.0.0)
Name of Virtual Server 1	WPNODE1
IP Address of Virtual Server 1	110.2.30.101 (subnet mask 255.255.0.0)
IP Address of Interconnect	110.4.30.101 (subnet mask 255.255.0.0)

3-4 Model Failover Environment

**Table 3-2
Application Specifics**

Service	LOTUS DOMINO 4.51
Location of Executables	H:\NOTES
Location of Data	H:\NOTES\DATA

**Table 3-3
Lotus Domino Resource Group Specifics**

Shared Disk	Disk H:
IP Address	110.2.30.101 (subnet mask 255.255.0.0)
Network Name	WPNODE1
Service	Lotus Domino Server

Hardware Requirements

Server Configuration

Two Compaq ProLiant 2500 servers, each with:

- 1 processor / 64-Mbytes RAM on each server
- (2) Compaq Netelligent 10/100 TX PCI UTP Controllers
- Compaq Fibre Channel Host PCI Controller

One Compaq ProLiant Fibre Channel Disk Storage System F2 with:

- Compaq ProLiant Fibre Channel Array Controller
- 1 or more SCSI hard disk drives

Client Configuration

Compaq Deskpro 2000 with:

- Compaq Netelligent 10/100 TX PCI UTP Network Interface Controller
- 32-Mbytes RAM

For detailed configuration information, see Appendix A.

Software Requirements

Server Configuration

- Compaq SmartStart and Support Software Release 3.41 or later
- Compaq Array Configuration Utility 1.20 or later
- Compaq NT Support Software Utility 2.03 or later
- Microsoft Windows NT Enterprise Server 4.0
- Microsoft Windows NT Service Pack 3
- Microsoft Cluster Server 1.0
- Lotus Domino Server 4.51

Client Configuration

- Compaq NT Support Software Utility 2.03 or later
- Microsoft Windows NT Workstation 4.0
- Microsoft Windows NT Service Pack 3
- Microsoft Cluster Administrator 1.0
- Lotus Notes Client

Note: To create a cluster, a domain environment is required using TCP/IP as the network protocol. As a cluster, both servers should be configured to be servers in the domain. It is highly recommended that neither server in a cluster be used as a Primary or Backup domain controller.

Chapter 4

Software Installation Process

Microsoft Cluster Server Installation

Microsoft Cluster Server must be installed on both servers before installing the application. For detailed instructions on how to setup a cluster refer to *Introduction to Compaq ProLiant Clusters*. The following table details the necessary information to complete the installation of Microsoft Cluster Server on both servers:

Table 4-1
Microsoft Cluster Server Installation Specifics

Domain Name	WPDOMAIN
Cluster Name	WPCLUSTER
Cluster IP address	110.2.30.100 (subnet mask 255.255.0.0)
Shared Disks	Disk G: (Quorum 100-MB), Disk H:
Cluster Admin User / Password	Administrator / <password>
Location of Cluster Executables	Default (C:\WINNT\SYSTEM32)
Quorum Disk	Disk G:

Keep this information and everything from the model environment section ready. All of these are used in installing Microsoft Cluster Server.

Lotus Domino Server 4.51 Installation

Pre-installation tasks

Make sure that all the required hardware is installed and connected and all required software, except Lotus Domino, is already installed and working.

Perform the following steps before installing Domino Server:

- Temporarily disable any screen savers or virus protection software.
- Stop any Lotus applications.
- If this is a new install, make sure there is no file named **NOTES.INI** in the *C:\WINNT* subfolder.
- If this is a re-install of the same product, follow these steps:
 1. Make sure Domino Server is shut down.
 2. Use a text editor to edit the **NOTES.INI** in your *C:\WINNT* subfolder.
 3. Delete all lines in the **NOTES.INI** file except the lines beginning with [Notes], KitType, and Directory.
 4. Open the Domino data directory *\NOTES\DATA* and delete the files, **DESKTOP.DSK**, **CERT.ID**, **SERVER.ID**, **USER.ID**, **LOG.NSF**, and **NAMES.NSF**.

Domino Server Installation

Follow these steps to install Lotus Domino Server:

1. Make sure that the shared drive Disk H: is owned by NODE1.
2. Insert CD-ROM in NODE1 and type the following command:

```
x:\W32INTEL\INSTALL\INSTALL.EXE  
where x is the drive letter of the CD-ROM
```

3. Enter your Name and Company Name.
-

4. Click **YES** to confirm names, or click **NO** to re-enter them.
5. There are two server options: Server Install and Customize Features – Manual Install. Select Customize Features.

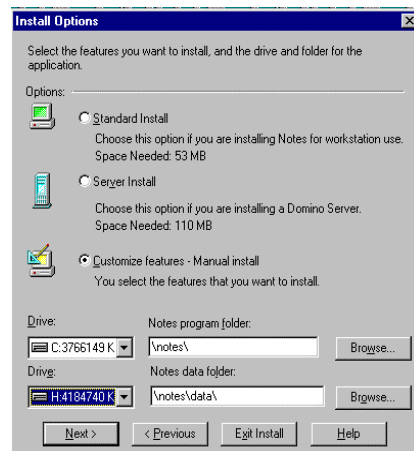

Figure 4-1. Customize Features – Manual Install

6. Enter **H:\NOTES** as the program folder and **H:\NOTES\DATA** as the data folder.

4-4 Software Installation Process

7. Selecting **Customize Features** allows the selection of components to be installed. Make sure **Notes Service Install** is selected, so that Domino will run as a service.

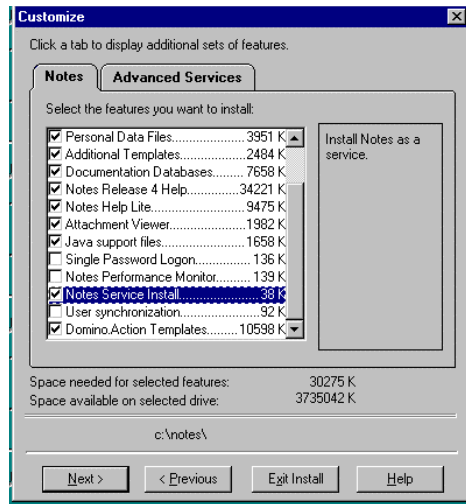

Figure 4-2. Customize Install Options

8. Select the program folder for Notes and Domino Server.
9. Click **YES** to begin copying files. Click **DONE** when installation is complete.
10. **Do NOT** start the Domino Server until both nodes have been setup, and the Domino Server is created in the Cluster Administrator.

Repeat the same steps to install NODE2. Make sure that the Disk H: is owned by NODE2 when installing Domino in NODE2.

Domino Server Setup

After installing NODE2, launch the Lotus NOTES client to automatically setup the Server. This sets up Domino's Server ID, Notes User ID, Organization Cert ID, and Public Address Book. Refer to the Lotus Domino Administration Guide for more details.

Follow these steps to setup the server:

1. Launch the Lotus NOTES client from the Start / Programs / Lotus Applications folder.

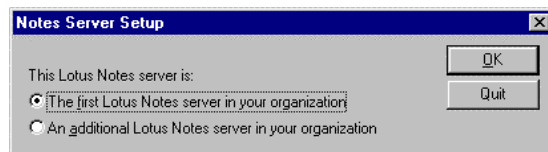

Figure 4-3. Notes Server Setup

2. Select “The first Lotus Notes server in your organization” and click **OK**.

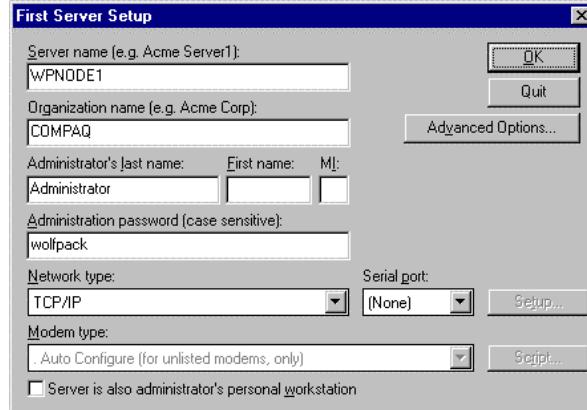

Figure 4-4. Server Setup Dialog

3. Enter the Domino Server WPNODE1 in the server name box.

4-6 Software Installation Process

4. Enter the company name in the organization box, i.e. **COMPAQ**.
5. Enter Last Name, First Name and Middle Initial in the Administrator box, i.e. Administrator.
6. Enter a case-sensitive password in the password box, i.e. **wolfpack**.
7. Select TCP/IP as the Network Protocol to use.
8. When prompted, select a time zone then click **OK**.

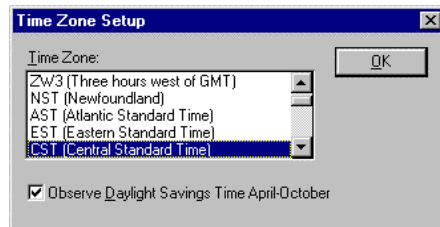

Figure 4-5. Time zone selection

9. Click **OK** when setup is complete.

After setting up the NODE2 server, move the **NOTES.INI** file from the `\\NODE2\WINNT\` folder to `H:\NOTES` so both systems will use the same setup information.

Use a text editor to edit the **NOTES.INI** file. Add `http` to the `ServerTasks` line of the shared **NOTES.INI** file.

NOTE: Do NOT go through the setup wizard in NODE1 like in NODE2, otherwise, it replaces the names and IDs that were assigned to the virtual server WPNODE1 entered during the setup. By moving the **NOTES.INI**, you are setting up the WPNODE1 in NODE1 exactly the same way you set up WPNODE1 in NODE2.

IMPORTANT: Do not start the Domino Server after the server setup. This attempts to start a non-existing server WPNODE1. After moving the **NOTES.INI** file and setting up the Domino Server group in the Microsoft Cluster Administrator, start the Domino Server group. This starts the Domino Server in WPNODE1. From the Control Panel, make sure that the Lotus Domino Server service is set to Manual.

Chapter 5

Configuration of Microsoft Cluster Server

Lotus Domino Resource Group

Use the following information to setup the Lotus Domino Resource Group.

Table 5-1
Lotus Domino Resource Group Properties

Resource Group Name	Lotus Domino
Preferred Nodes	None
Failover Option	Default
Failback Option	Default, No Failback

Either create a resource group and move one of the disks to this group, or rename an existing group already containing a disk. For this cluster model, the fourth disk group is renamed to Lotus Domino. It already contains a shared disk, Disk H:, so a physical disk does not need to be created.

Dependencies

The following dependencies should be observed when creating the resources:

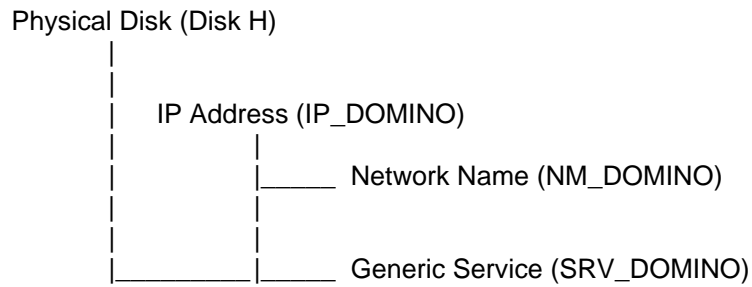

Figure 5-1. Group and Resource Name Dependencies

Creating the Lotus Domino Resources

Use Table 5-2 to create the following resources for this group.

Table 5-2

Resource Group (Lotus Domino)

Physical Disk	Disk H:	Disk H:
IP Address	IP_DOMINO	110.2.30.101
Network Name	NM_DOMINO	WPNODE1
Generic Service	SRV_DOMINO	Lotus Domino Server

The following sections detail the configuration of each resource.

Physical Disk

Use the following information to setup the Shared Disk resource.

Table 5-3

Lotus Domino 4.51 Group (Physical Disk Properties)

Resource Name	Disk H:
Resource Type	Physical Disk
Shared Disk	Disk H:
Dependencies	None

Normally the Shared Disk resource already exists in the cluster and a resource does not need to be created. Copy this Resource to the Resource Group just created or rename the Group where this resource is located.

IP Address

Use the following information to setup the IP Address resource.

Table 5-4

Lotus Domino 4.51 Group (IP Address Properties)

Resource Name	IP_DOMINO
Resource Type	IP Address
IP address	110.2.30.101 (subnet mask 255.255.0.0)
Dependencies	None

5-4 Configuration of Microsoft Cluster Server

1. Enter the name of the IP Address resource. Click **Next**.

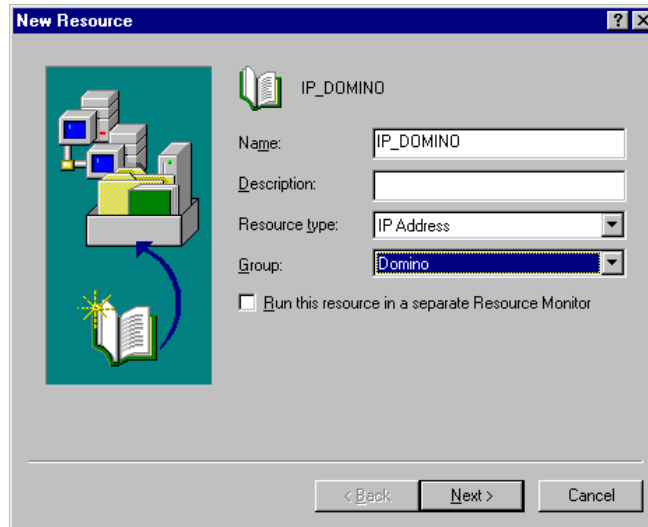

Figure 5-2. IP Address Name

2. Enter the possible nodes that the IP Address can host. Click **Next**.

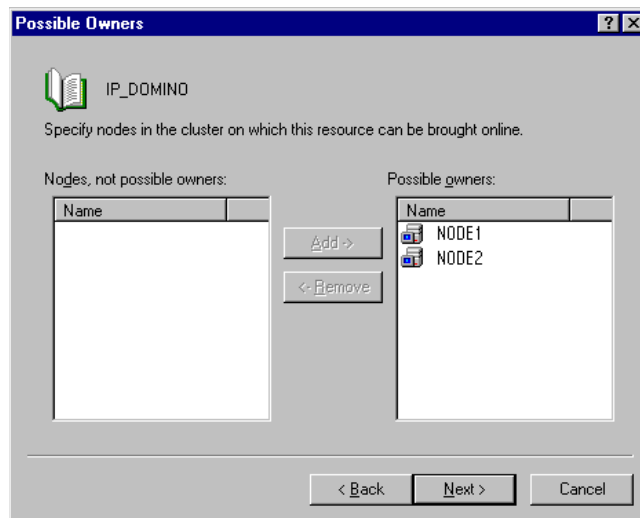

Figure 5-3. IP Address Possible Nodes

3. There are no dependencies so simply click **Next**.

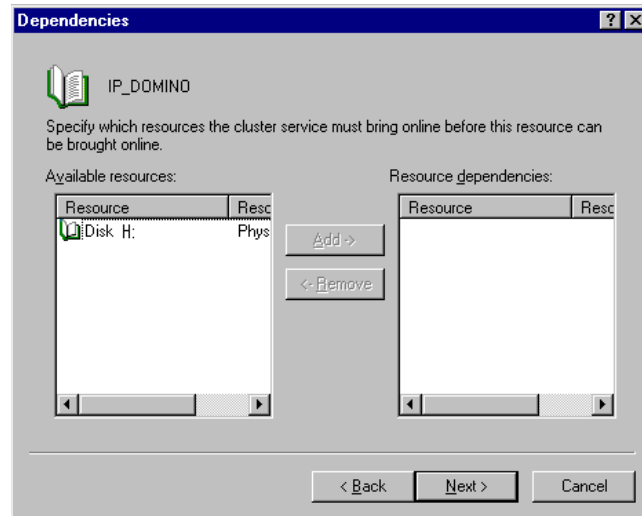

Figure 5-4. IP Address Dependencies

4. Enter the IP address of the virtual server for Lotus Domino, including the proper subnet mask, which should be the same subnet mask used for the domain. Click **Finish**.

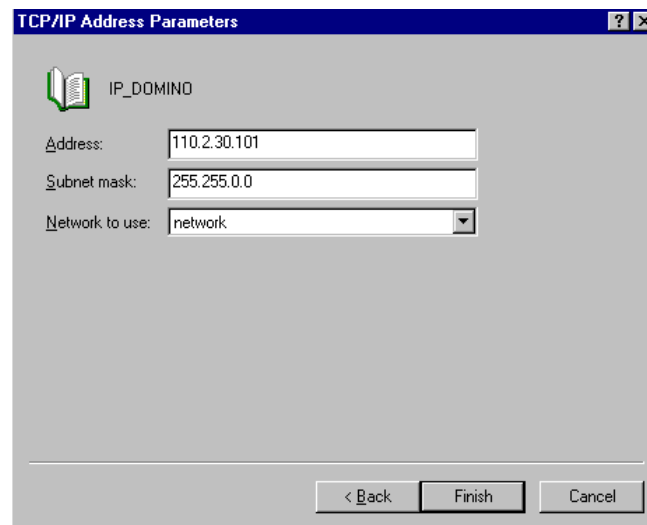

Figure 5-5. IP Address Parameters

Network Name

Use the following information to setup the Network Name resource.

Table 5-5

Lotus Domino 4.51 Group (Network Name Resource)

Resource Name	NM_DOMINO
Resource Type	Network Name
Network Name	WPNODE1
Dependencies	IP_DOMINO

1. Enter the name of the Network Name resource. Click **Next**.

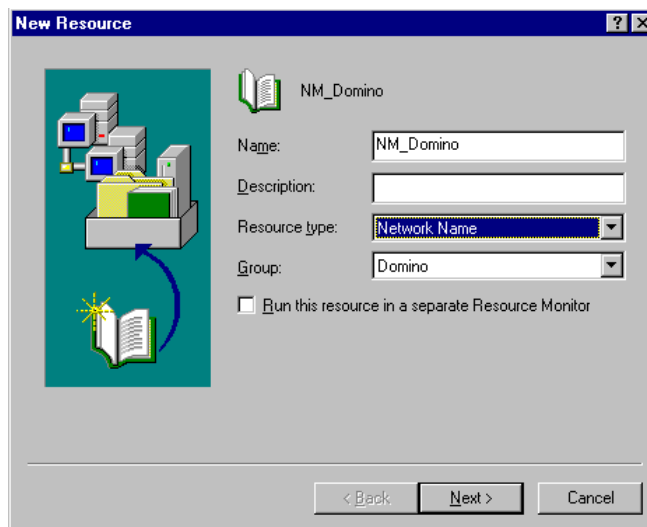

Figure 5-6. Network Name Resource Name

2. Select the possible nodes that the resource can host. Click **Next**.

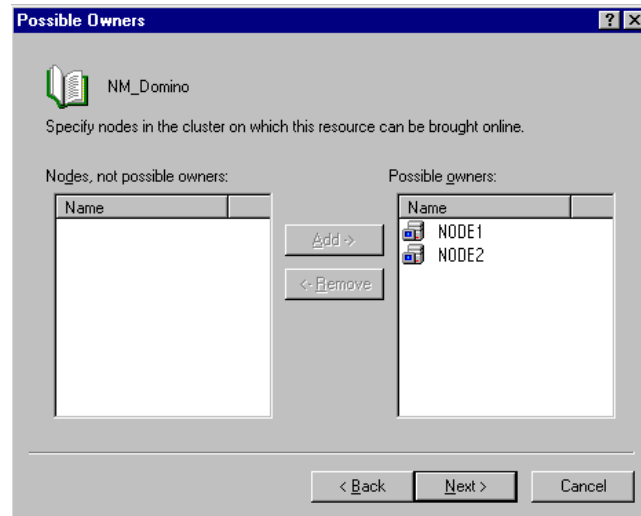

Figure 5-7. Network Name Resource Possible Nodes

3. Enter the dependencies of the resource. Select the IP_DOMINO resource. Click **Next**.

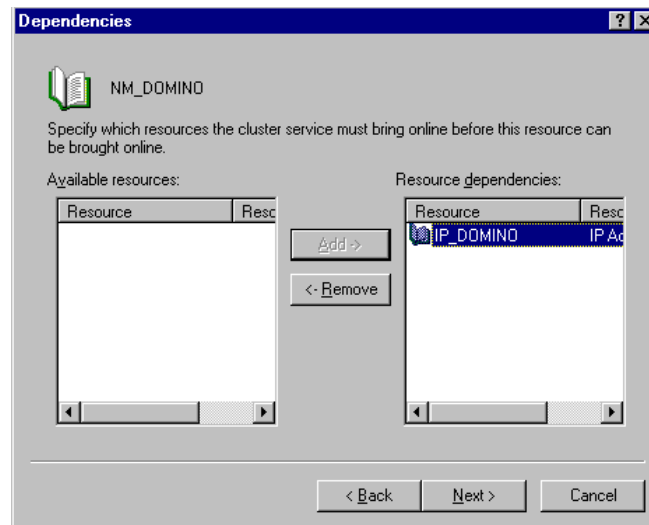

Figure 5-8. Network Name Resource Dependencies

5-8 Configuration of Microsoft Cluster Server

4. Enter the name of the virtual server. Click **Finish**.

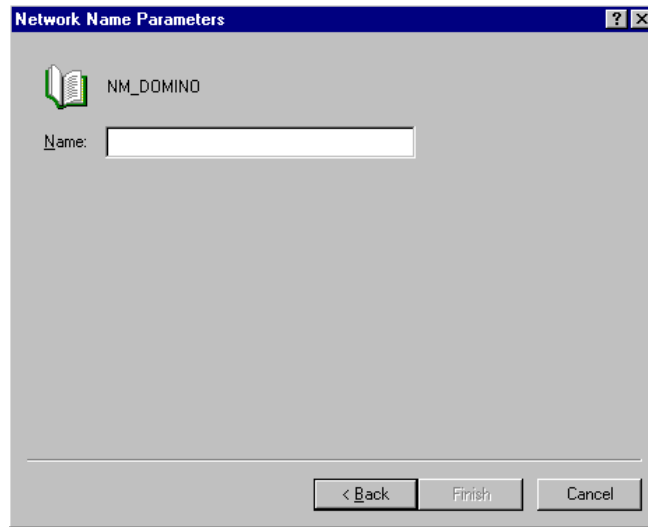

Figure 5-9. Network Name Resource Parameters

Generic Service

Use the following information to setup the Lotus Domino Server resource.

Resource Name	SRV_DOMINO
Resource Type	Generic Service
Service Name	Lotus Domino Server
Dependencies	Disk H: and NM_DOMINO

1. Enter the name of the Generic Service resource for the Lotus Domino service. Click **Next**.

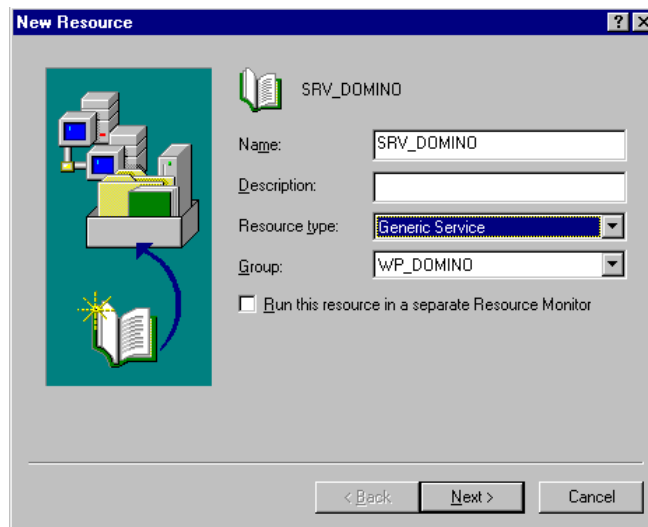

Figure 5-10. Lotus Domino Service Name

5-10 Configuration of Microsoft Cluster Server

2. Enter the possible nodes that you want the service to host. Click **Next**.

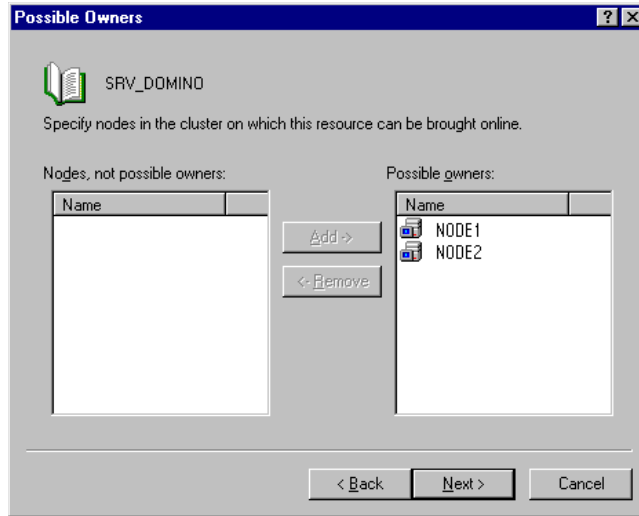

Figure 5-11. Lotus Domino Service Possible Nodes

3. For dependencies, enter the Disk H: and IP_LOTUS DOMINO. Click **Next**.

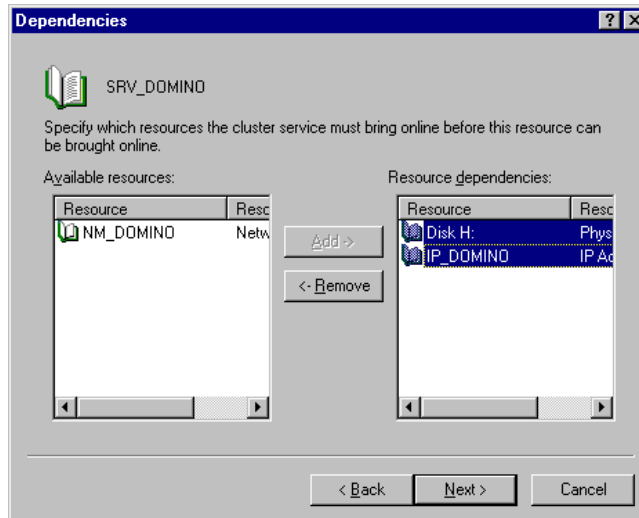

Figure 5-12. Lotus Domino Service Dependencies

4. Enter the **Lotus Domino Server** Service to be used by the resource.
Click **Next**.

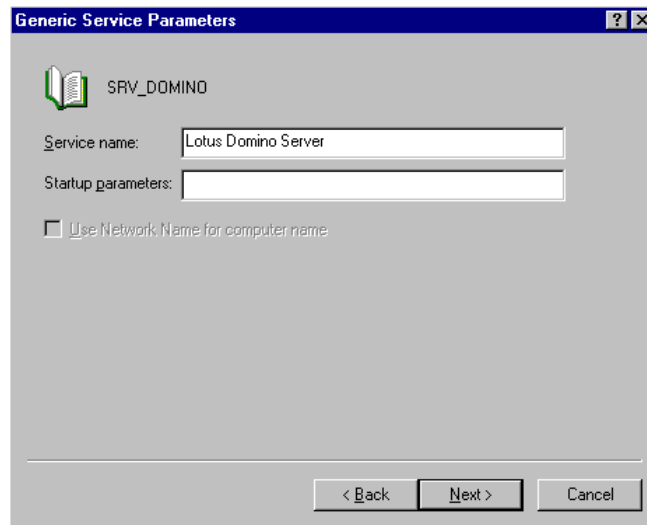

Figure 5-13. Lotus Domino Service Parameters

5-12 Configuration of Microsoft Cluster Server

5. Add **System\CurrentControlSet\Services\Lotus Domino Server** registry key to be replicated between the cluster. Click **Finish**.

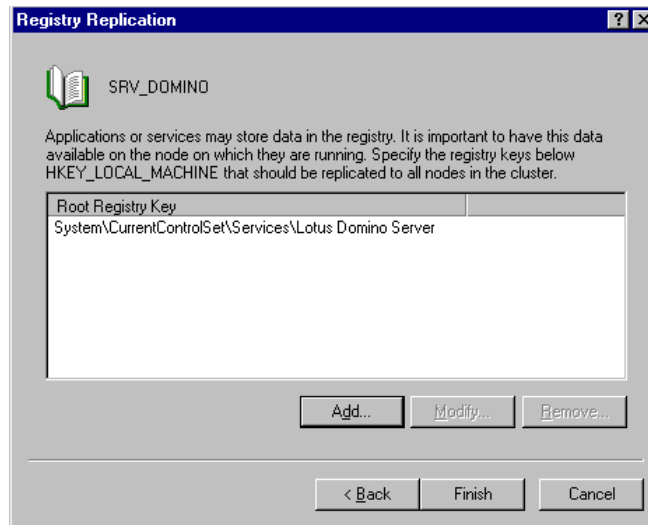

Figure 5-14. Lotus Domino Service Registry Replication Parameters

To move the resource group immediately to the another node, change the Advanced Properties of each Resource by setting the Threshold value of the Restart to zero (0), and allow it to affect the whole group. This setting prevents the resource from re-starting on the same node, since it is set to zero. If a failure occurs on any resource on that resource group, it will move the whole resource group to the other cluster node and restart the service.

Starting the Domino Server Group

From the Cluster Administrator, bring the Domino Server On-line. This starts the Domino Server on the node that owns the group.

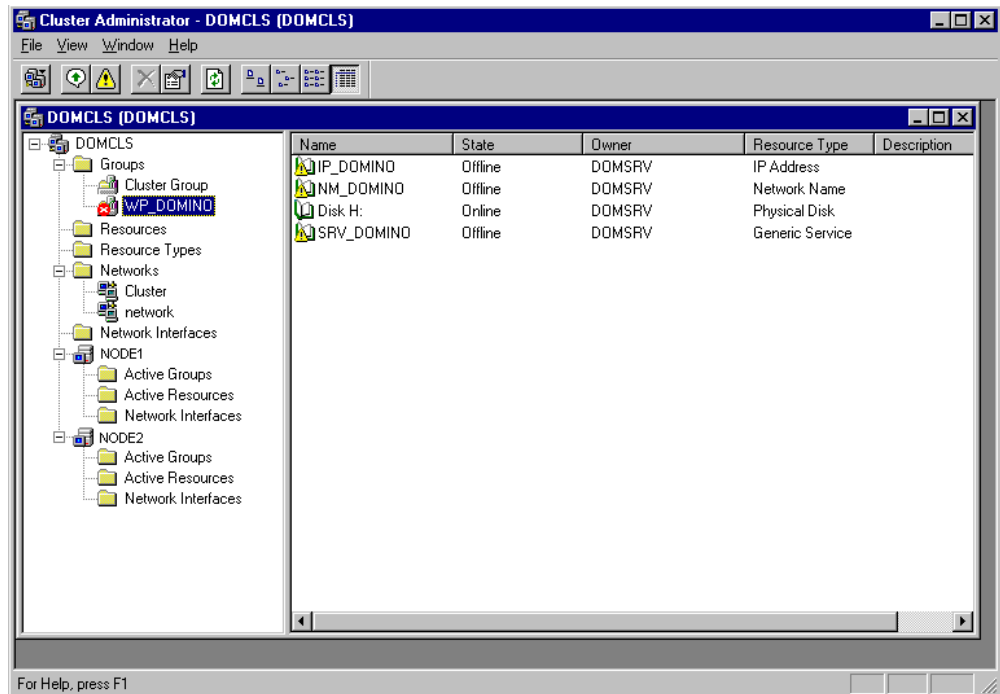
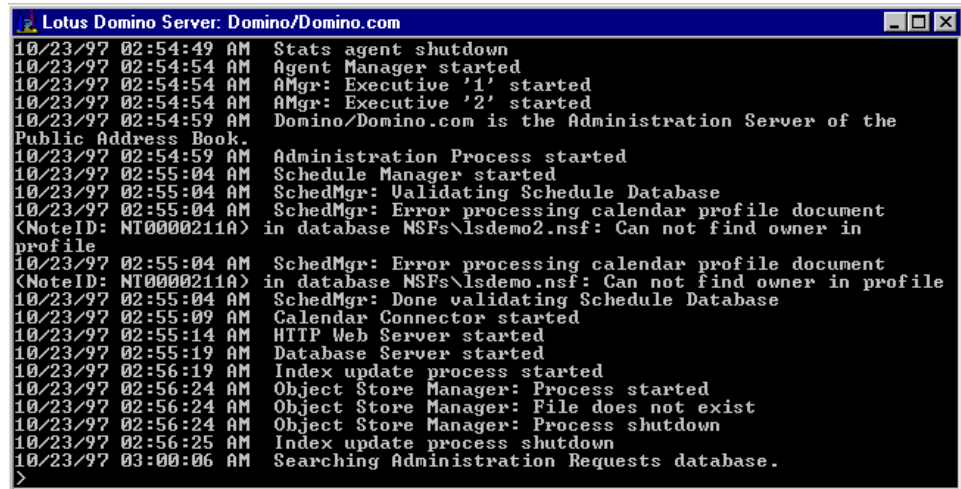

Figure 5-15. Cluster Administrator showing the Domino Server Group

5-14 Configuration of Microsoft Cluster Server

This is NODE1, which currently owns the Domino Server group. A similar server dialog is started as shown:



```
Lotus Domino Server: Domino/Domino.com
10/23/97 02:54:49 AM Stats agent shutdown
10/23/97 02:54:54 AM Agent Manager started
10/23/97 02:54:54 AM AMgr: Executive '1' started
10/23/97 02:54:54 AM AMgr: Executive '2' started
10/23/97 02:54:59 AM Domino/Domino.com is the Administration Server of the
Public Address Book.
10/23/97 02:54:59 AM Administration Process started
10/23/97 02:55:04 AM Schedule Manager started
10/23/97 02:55:04 AM SchedMgr: Validating Schedule Database
10/23/97 02:55:04 AM SchedMgr: Error processing calendar profile document
<NoteID: NT0000211A> in database NSFs\lsdemo2.nsf: Can not find owner in
profile
10/23/97 02:55:04 AM SchedMgr: Error processing calendar profile document
<NoteID: NT0000211A> in database NSFs\lsdemo.nsf: Can not find owner in profile
10/23/97 02:55:04 AM SchedMgr: Done validating Schedule Database
10/23/97 02:55:09 AM Calendar Connector started
10/23/97 02:55:14 AM HTTP Web Server started
10/23/97 02:55:19 AM Database Server started
10/23/97 02:56:19 AM Index update process started
10/23/97 02:56:24 AM Object Store Manager: Process started
10/23/97 02:56:24 AM Object Store Manager: File does not exist
10/23/97 02:56:24 AM Object Store Manager: Process shutdown
10/23/97 02:56:25 AM Index update process shutdown
10/23/97 03:00:06 AM Searching Administration Requests database.
>
```

Figure 5-16. Domino Server Dialog

The Domino Server is currently running in WPNODE1. This can be accessed by launching the Lotus Notes client.

Tuning the Domino Server

The first time the Domino Server is started from the Cluster Administrator, the Server Startup window is displayed on the node that owns the Domino Server:

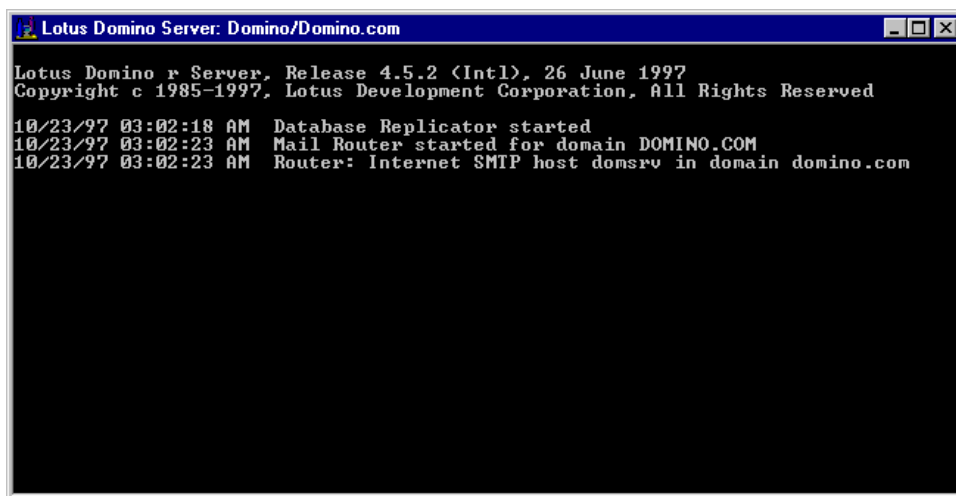

```
Lotus Domino r Server, Release 4.5.2 <Intl>, 26 June 1997
Copyright c 1985-1997, Lotus Development Corporation, All Rights Reserved
10/23/97 03:02:18 AM Database Replicator started
10/23/97 03:02:23 AM Mail Router started for domain DOMINO.COM
10/23/97 03:02:23 AM Router: Internet SMTP host domsrv in domain domino.com
```

Figure 5-17. Server Startup window

Changes can be made to the registry to improve server performance. For this cluster model, the following two recommended registry changes were made:

HKEY_LOCAL_MACHINE\System\CurrentControlSet\Control\Session Manager\Memory Management\LargeSystemCache to be set to 0 (zero)

HKEY_LOCAL_MACHINE\System\CurrentControlSet\Control\PriorityControl\Win32PrioritySeparation to be set to 0 (zero)

This should only be done if recommendations are received from the Domino Server, otherwise, leave all registry settings to default.

Chapter 6

Lotus Notes Client Installation

You **must** configure Microsoft Cluster Server and start the Notes Service before installing the Lotus Notes Client. If you have not configured Microsoft Cluster Server, refer to the section, “Configuration of Microsoft Cluster Server” before proceeding with the Lotus Notes Client Installation.

Before installing the client, make sure that there are no Lotus Applications running in the workstation. Temporarily stop all screen savers and virus-detection programs.

Installing the Lotus Notes Client

Follow these steps to install the Lotus Notes client:

1. Insert the CD-ROM in NODE1 and type the following command:

```
x:\W32INTEL\INSTALL\INSTALL.EXE
```

where *x* is the drive letter of the CD-ROM

2. Enter Name and Company Name.
3. Click **YES** to confirm names, or click **NO** to re-enter them.

6-2 Lotus Notes Client Installation

4. Select the **Standard Install**.

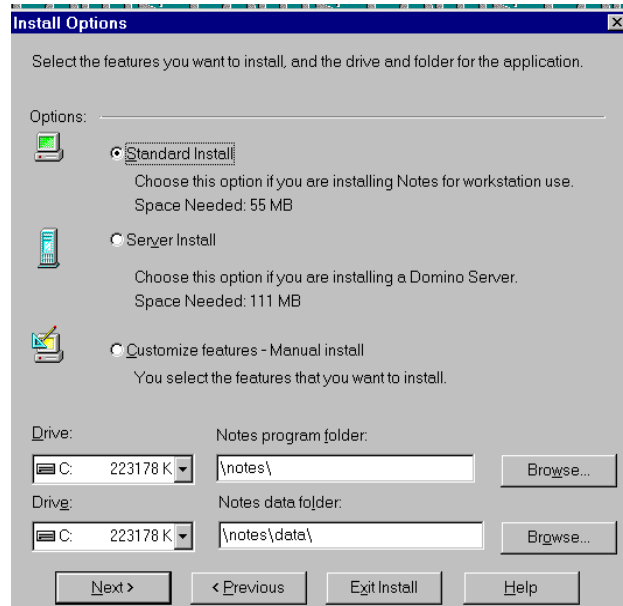

Figure 6-1. Install Options

5. Accept the default location **C:\NOTES** as the program location and **C:\NOTES\DATA** as the data location.
6. Select the program folder for Lotus Notes.
7. Click **YES** to begin copying files. Click **DONE** when installation is complete.

Lotus Notes Setup

Follow these steps to setup the Notes client:

1. Launch the Lotus NOTES client from the Start / Programs / Lotus Applications folder.
-

2. Select **Network Connection (via LAN)** as the type of connection to use then click **OK**.

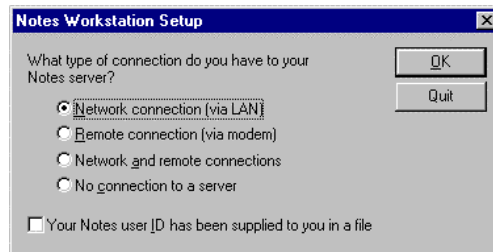

Figure 6-2. Notes Client Network Setup

3. Enter the user name: **Administrator**.
4. Enter the Home server name: **WPNODE1**.
5. Enter the Network type: **TCP/IP**.

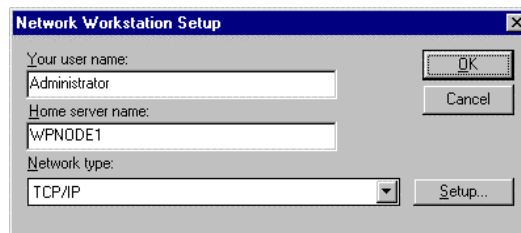

Figure 6-3. Notes Client Setup Dialog

6-4 *Lotus Notes Client Installation*

6. Enter the Administrator password.

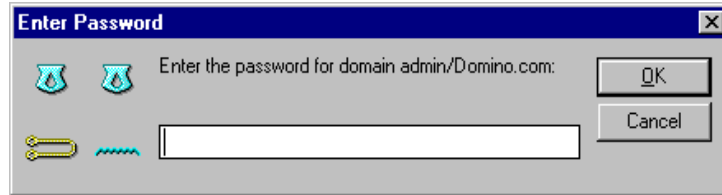

Figure 6-4. Administrator password

7. Select a time zone then click **OK**.
 8. Click **OK** when setup is complete.
-

Chapter 7

Verifying the Failover

Follow these steps to verify a successful failover:

1. Connect the Lotus Notes client to the Domino Server WPNODE1 and open a database by selecting **File** → **Database** → **Open menu**. For this example, the Address Book from WPNODE1 is used, not the local address book.

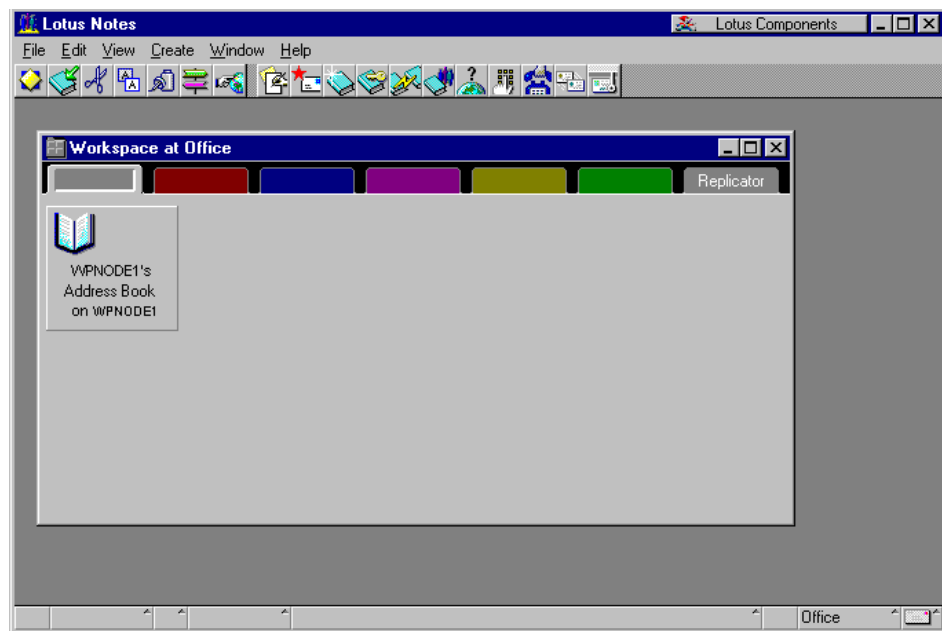

Figure 7-1. Open Database dialog

7-2 Verifying the Failover

2. Enter the password for the Domino Server WPNODE1 (e.g. wolfpack).

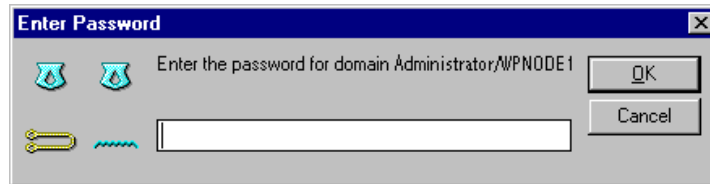

Figure 7-2. Password

3. This opens the Address Book as shown in Figure 7-3.

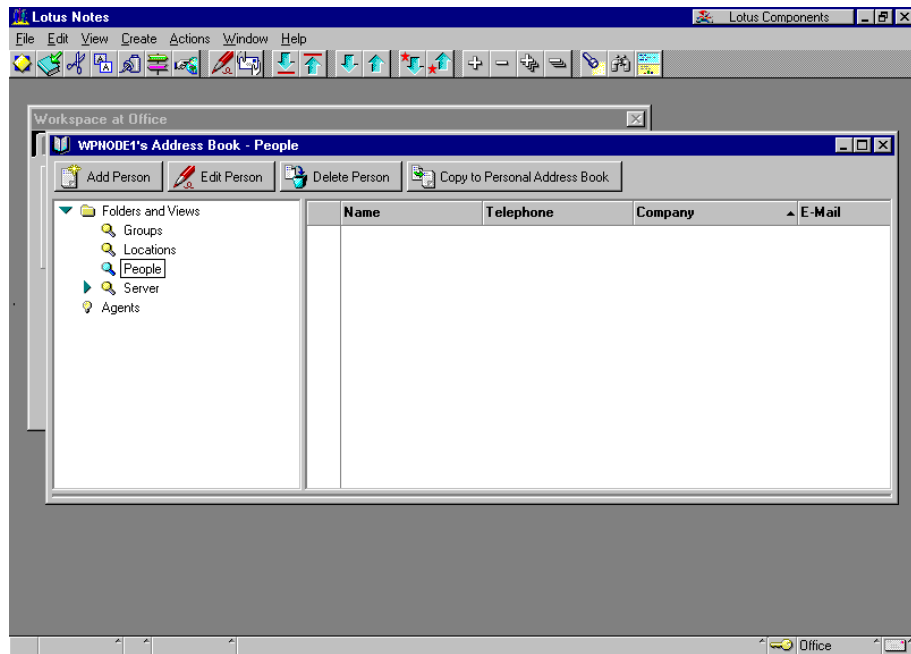

Figure 7-3. Address Book in WPNODE1

4. Create a person named **John Smith** and fill in the items about him. **Save and Close** the Address Book.

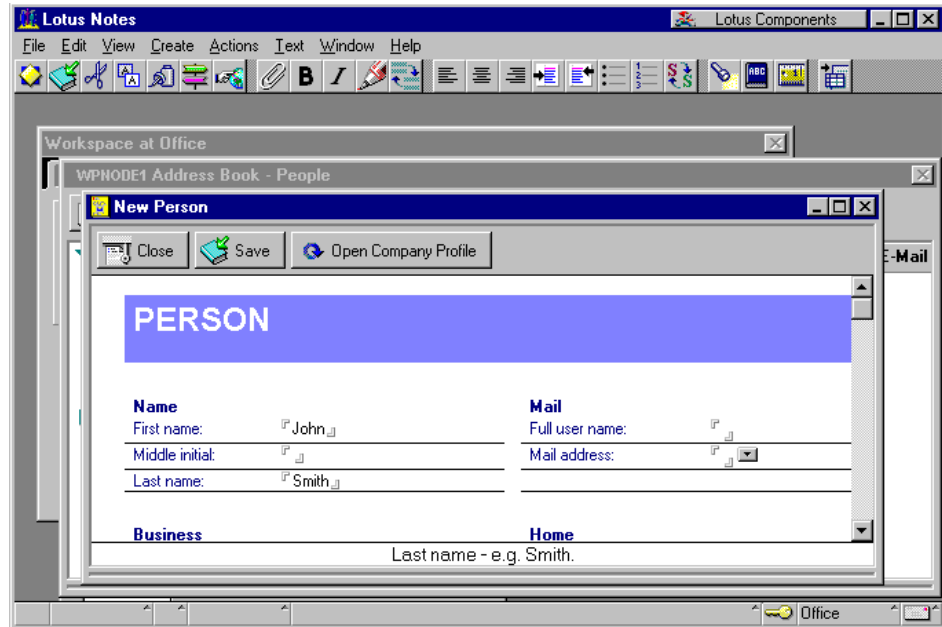

Figure 7-4. Create an Address Book Entry

7-4 Verifying the Failover

- Using the Cluster Administrator, move the Lotus Domino group from the server it is running on to the other server. On the client machine, Open the Address Book again. It should be possible to view the same information and even add new entries to the database.

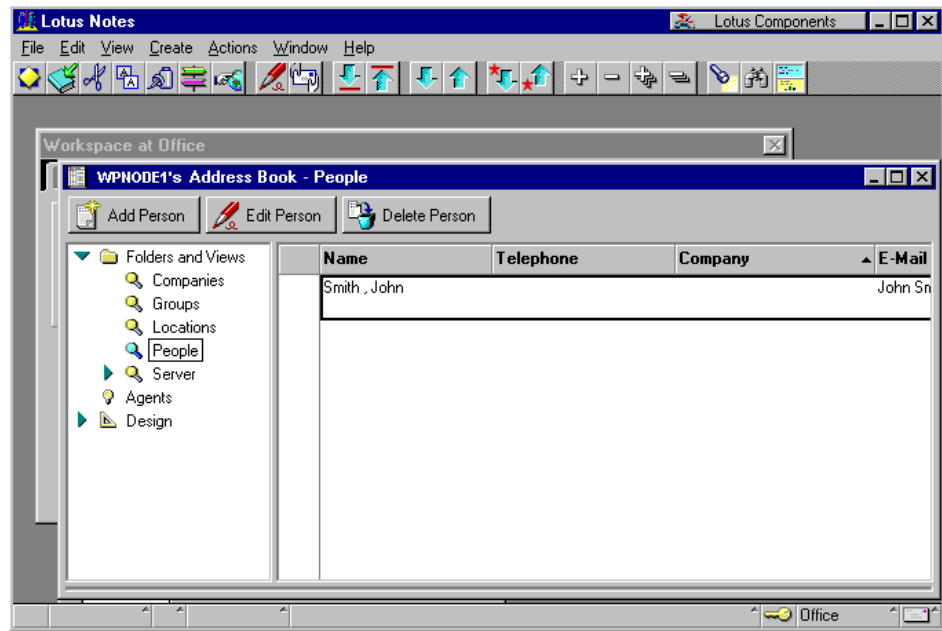

Figure 7-5. Address Book reflecting the same information

Glossary

Availability The ability of a system to appear to the users as if it was operating continuously, even though failures have occurred.

Cluster A cluster is a set of independent computer systems working together as a single system. The cluster software directs client requests to one of the systems in the cluster based on resource accessibility, server load, and application requirements. When a system in the cluster fails the cluster software will recover and disperse the work from the failed system amongst the remaining systems in the cluster. When the overall load exceeds the capabilities of the systems in the cluster, additional systems may be added to the cluster. The failure of a system in the cluster will not affect the other systems and in certain cases the client applications should be unaware of the failure, except for some loss of service for a short period of time.

Given the above definition, it would be hard to distinguish a cluster from a general distributed system; therefore, clusters provide the following additional capabilities:

- Every system in the cluster must have full connectivity and communications with all other systems in the cluster.
- Systems in the cluster know all the other systems in the cluster; they join in order to form a cluster. The cluster systems also know when systems join or leave the cluster, via a connection manager.
- Systems in the cluster know what resources are available on all other members of the cluster.
- There is a virtual circuit, provided by the connection manager that provides reliable delivery of messages between systems in the cluster.

G-2 Glossary

Connect Descriptor	A specially formatted description of the destination for a network connection. Connect descriptors are constructed using a set of keywords and values mapped to service names.
Failover	The time it takes a resource to failover from one system to another. For example, if a resource is to be polled at a 1-second interval, then it may be determined that after two poll intervals, that a resource is dead and that it should be restarted or failed over. Also, assuming that the local restart count for the resource is 4, then 4 of these timeouts would be required before the resource is failed over to another system. Given a 1-second interval, there would be a period of 2 seconds times the 4 retries - or a total of 8 seconds before the resource failed over to another system.
Member	A system which has joined a cluster.
Node	<i>See</i> System.
Quorum	A voting mechanism maintained by the connection manager. A simple quorum voting mechanism is used to indicate when more than half of the available votes are present in the cluster. Note that a member (or many members) in the cluster can have more than one vote. In addition, a resource available within the cluster can have a vote. This latter ability allows two systems cluster to function in the presence of a communication or system failure, by having the system that continues functioning and reserves the resource to obtain a quorum.
Quorum resource	A quorum resource is any resource that has writable persistent storage for maintaining cluster database change log records.

Resource	A physical or logical entity that is managed. They include, but are not limited to: disks, tapes, printers, CD-ROMs, IP address, etc.
Server	The layer of software running on a cluster node which performs service registration or advertisement. Any software that uses this layer inherits its properties.
Server application	The actual application software running on a cluster node, regardless of whether it does service registration.
Service	A data set or operation set exported by application servers to their clients. This term is distinguished from a Windows NT Service.
Service Name	A short, convenient name mapped to a network address contained in a TNS connect descriptor. Users need only know the appropriate service name to make a TNS connection.
Shared disk	A cluster organization that requires all systems of the cluster to have access to shared Disks.
Shared nothing	A cluster organization in which disks are 'owned' by a single system of the cluster and requests for disk access is directed to the system that 'owns' the disk.
Shared resource	A cluster organization in which some resources are accessible to all systems in the cluster.
System	A complete computer system capable of operating independently (either a single processor system or an SMP system), for example, a PC.

Index

A

address book, 7-1, 7-2
address book entry, creating, 7-3
advantages of a failover, 2-2
audience, expected, 1-1

C

cable, crossover, 3-1
client configuration, 3-5, 3-6
cluster executables, location of, 4-1
Compaq
 Array Configuration Utility, 3-6
 Deskpro 2000, 3-5
 Fibre Channel Host PCI Controller,
 3-5
 Netelligent 10/100 TX PCI UTP
 Controllers, 3-5
 NT Support Software Utility, 3-6
 ProLiant Fibre Channel Array
 Controller, 3-5
 ProLiant Fibre Channel Disk
 Storage System F2, 3-5
 ProLiant servers, 3-1, 3-5
 ProLiant Storage Unit, 3-1
 SmartStart, 3-6
configuration
 Microsoft Cluster Server, 5-1
 client, 3-5, 3-6
 disk, A-1, A-2
 hardware, A-1
 server 3-5, 3-6, A-1, A-2
 standard ProLiant Cluster, 3-1
create an Address Book entry, 7-3

creating the Lotus Domino Resources,
 5-2
crossover cable, 3-1
customize features – manual install, 4-
 3
customize install options, 4-4

D

data folder, 4-3
data, location of, 3-4
dedicated server interconnect, 3-1
dependencies, 5-2
 Group and Resource Name, 5-2
 IP Address, 5-5
 Lotus Domino Service, 5-10
 Network Name Resource, 5-7
disadvantages of a failover, 2-2
disk configuration, A-1, A-2
Domino Server
 installation, 4-2
 not functioning, B-1
 setup, 4-5
 tuning, 5-15
Domino Server Group, starting, 5-13
duplexed network cards, 3-2

E

error occurs, B-1
executables, location of, 3-4
expected audience, 1-1

Index -2

F

failover
 environment, 3-1
 advantages of, 2-2
 disadvantages of, 2-2
 Overview of, 2-1
 resource, 2-1
 service, 2-1
 types of, 2-1
 verifying, 7-1

G

generic service, 5-9
generic service resource, 5-9
Group and Resource Name
 Dependencies, 5-2

H

hardware configuration, A-1
hardware requirements, 3-5

I

ID
 Notes User, 4-5
 Organization Cert, 4-5
 Server, 4-5
install options, 6-2
Installation
 process, software, 4-1
 Lotus Domino Server 4.51, 4-2
 Lotus Notes Client, 6-1
 Microsoft Cluster Server, 4-1
IP Address
 dependencies, 5-5
 parameters, 5-5
 resource, 5-3

L

location
 Cluster Executables, 4-1
 data, 3-4
 executables, 3-4
Lotus Domino
 Resource Group, 5-1
 Resources, creating, 5-2
 Server 4.51 installation, 4-2
 Server resource, 5-9
 Service dependencies, 5-10
 Service parameters, 5-11
 Service Registry Replication
 parameters, 5-12
Lotus Notes Client, 3-6
Lotus Notes Client installation, 6-1
Lotus Notes Client setup, 6-2

M

Microsoft Cluster Server installation,
 4-1
Microsoft Windows NT
 Enterprise Server, 3-6
 Service Pack 3, 3-6
 Workstation 4.0, 3-6

N

network cards, duplexed 3-2
network cards, PCI 3-1
Network Name resource, 5-6
 dependencies, 5-7
 parameters, 5-8
network protocol, 3-2, 3-6
Notes Client Network setup, 6-3
Notes settings not the same, B-1
Notes User ID, 4-5

O

options, install, 6-2
 Organization Cert ID, 4-5
 outage, planned, 2-2
 outage, unplanned, 2-2
 overview of a failover, 2-1

P

parameters
 IP Address 5-5
 Lotus Domino Service, 5-11
 Lotus Domino Service Registry
 Replication, 5-12
 Network Name Resource 5-8
 PCI network cards, 3-1
 planned outage, 2-2
 pre-installation tasks, 4-2
 private hub, 3-1
 program folder, 4-3
 ProLiant Storage Unit, 3-1
 Public Address Book, 4-5

Q

quorum disk, 4-1

R

registry changes, 5-15
 registry key, 5-12
 requirements, hardware, 3-5
 requirements, software, 3-6
 resource DLL, 2-1
 resource failover, 2-1

S

screen savers, 4-2, 6-1
 SCSI hard disk drives, 3-5
 selecting a time zone, 4-6, 6-4
 server configuration, 3-5, 3-6, A-1, A-2
 Server ID, 4-5
 Server Startup window, 5-15
 service failover, 2-1
 Setup
 Domino Server, 4-5
 Lotus Notes Client, 6-2
 Notes Client Network, 6-3
 Shared Disk resource, 5-3
 software installation process, 4-1
 software requirements, 3-6
 standard ProLiant Cluster
 configuration, 3-1
 starting the Domino Server Group,
 5-13

T

TCP/IP, 3-2, 3-6
 text conventions, 1-2
 time zone selection, 4-6, 6-4
 troubleshooting, B1
 tuning the Domino Server, 5-15
 types of failover, 2-1

U

unplanned outage, 2-2

V

verifying the failover, 7-1
 virtual server, 5-8