

## USING THIS GUIDE

Some or all of the following format conventions are used in this guide to distinguish elements of text:

- Names of keys are shown in bold type as they appear on the keyboard, for example, **Ctrl, Backspace, Tab**.
- Keys that you should press at the same time are represented by the key names and the plus (+) symbol, for example, **Ctrl+Alt+Delete**.
- Commands are presented in lowercase, bold type as shown here: **install** or **a:\install**.
- An arrow symbol is used to separate icons or menu options that you should select in succession, for example, click the Start button → Settings → Control Panel.



**WARNING:** Text set off in this manner indicates that failure to follow directions could result in bodily harm or loss of life.

---



**CAUTION:** Text set off in this manner indicates that failure to follow directions could result in damage to equipment or loss of information.

---

**IMPORTANT:** Text set off in this manner presents clarifying information or specific instructions.

**NOTE:** Text set off in this manner presents commentary, sidelights, or interesting points of information.



# CONTENTS

*preface*

## **USING THIS GUIDE**

*chapter 1*

### **GETTING STARTED**

Setting Up the Computer.....	1-1
Charging the Battery Pack for the First Time .....	1-2
Connecting the Computer to AC Power .....	1-3
Opening the Computer.....	1-4
Turning On the Computer.....	1-5
Setting Up the Software .....	1-5
Operating the Computer During Setup.....	1-6
Choosing a Language.....	1-6
Removing the Operating System.....	1-7
Restoring Your Operating System and Software Preinstalled by Compaq .....	1-7
Completing Setup.....	1-8
Registering the Computer (North America Only) .....	1-8
Locating Online Resources.....	1-8

*chapter 2*

### **COMPUTER AT A GLANCE**

Front Components .....	2-1
Rear Components .....	2-2
Left Side Components.....	2-3
Right Side Components.....	2-4
Top Components .....	2-6
Bottom Components.....	2-8
Adjusting the Computer Using the Tilt Feet.....	2-9

*chapter 3*

**KEYBOARD AND POINTING DEVICE**

Keyboard Components .....	3-2
Programmable Keys.....	3-3
Using Programmable Keys.....	3-3
Assigning Programmable Keys.....	3-4
Unassigning Programmable Keys .....	3-5
Adding Schemes.....	3-5
Removing Schemes .....	3-6
Showing the Key Assignments in the System Tray.....	3-6
Hotkeys .....	3-7
Switching Displays.....	3-7
Adjusting System Warning Beeps.....	3-7
Initiating QuickLock/QuickBlank.....	3-8
Accessing Power Management .....	3-8
Accessing the Battery Gauge .....	3-8
Accessing the Brightness Control .....	3-9
Accessing the Embedded Numeric Keypad.....	3-9
Stretching Text .....	3-10
Using the Pointing Device.....	3-11
Replacing the Pointing Device Cap.....	3-12

*chapter 4*

**BATTERY PACKS**

Battery Components .....	4-2
Charging Battery Packs .....	4-3
Ensuring Battery Gauge Accuracy .....	4-3
Identifying a Low Battery Condition .....	4-4
Resolving a Low Battery Condition .....	4-4
Connecting to an Electrical Outlet .....	4-5
Connecting to the Optional Automobile/Aircraft Adapter .....	4-6
Resolving a Low Battery Condition by Replacing the Battery Pack .....	4-7
Resolving a Low Battery Condition with No Power Sources Available.....	4-7
Removing the Battery Pack from the Battery Bay .....	4-8
Inserting the Battery Pack into the Battery Bay .....	4-9
Storing Battery Packs.....	4-9
Maximizing Battery Life .....	4-10
Recycling Used Battery Packs.....	4-11

*chapter 5*

**COMPUTER POWER AND POWER MANAGEMENT**

- Leaving On the Computer ..... 5-1
- Turning Off the Computer ..... 5-1
- Managing Power ..... 5-2
- Accessing Power Management ..... 5-2
- Power Management Levels ..... 5-3
  - Setting the Power Management Level  
with Power Properties ..... 5-3
  - Setting the Power Management Level  
with Computer Setup ..... 5-4
- Suspend ..... 5-4
  - Benefits of Using Suspend..... 5-4
  - Initiating Suspend ..... 5-5
  - Exiting Suspend ..... 5-6
- Hibernation ..... 5-7
  - Benefits of Using Hibernation ..... 5-7
  - Initiating Hibernation..... 5-8
  - Enabling/Disabling Hibernation ..... 5-8
  - Exiting Hibernation..... 5-9
- Timeout ..... 5-9
  - Setting Component Timeouts ..... 5-10
  - Setting the Screen Saver Timeout..... 5-10

*chapter 6*

**REMOVABLE DRIVES**

- Using Removable Drives ..... 6-1
- Caring for Removable Drives ..... 6-2
- MultiBay Weight Saver..... 6-3
- Handling Drives ..... 6-3
- Hard Drives ..... 6-4
  - Removing a Hard Drive from the Hard Drive Bay ..... 6-4
  - Inserting a Hard Drive into the Hard Drive Bay ..... 6-5
  - Removing a Hard Drive from the MultiBay..... 6-6
  - Inserting a Hard Drive into the MultiBay..... 6-7

CD-ROM Drives .....	6-8
Removing the CD-ROM Drive from the MultiBay .....	6-8
Inserting the CD-ROM Drive into the MultiBay .....	6-9
Working with Compact Discs .....	6-10
Diskette Drives.....	6-12
Removing the Diskette Drive from the MultiBay.....	6-12
Inserting the Diskette Drive into the MultiBay.....	6-13
Working with Diskettes.....	6-13

*chapter 7*

**SECURITY**

Types of Security .....	7-1
DriveLock .....	7-2
Overview .....	7-2
Establishing DriveLock Protection .....	7-3
Entering the DriveLock Password.....	7-4
Changing the User Password.....	7-4
Changing the Master Password.....	7-5
Removing DriveLock Protection .....	7-6
Power-On Password.....	7-6
Using the Power-On Password.....	7-6
Setting the Power-On Password Using Windows 95/NT .....	7-7
Setting the Power-On Password Using Computer Setup.....	7-8
Changing the Power-On Password.....	7-9
Deleting the Power-On Password .....	7-9
Setup Password .....	7-9
Using the Setup Password .....	7-9
Setting the Setup Password .....	7-10
Changing the Setup Password.....	7-11
Deleting the Setup Password.....	7-11
Change/Delete Password Symbols .....	7-11
Quick Controls.....	7-12
Using the Quick Controls.....	7-12
Enabling and Disabling QuickLock/QuickBlank Using Windows 95/NT.....	7-13
Enabling and Disabling QuickLock/QuickBlank Using Computer Setup .....	7-13
Disabling and Enabling Devices.....	7-14
Using the Cable Lock .....	7-15

*chapter 8*

**INTERNAL MODEM**

Modem Overview ..... 8-1

Using Modem Software ..... 8-2

Connecting the Modem in North America,  
Latin America, or Japan ..... 8-3

Connecting the Modem in Europe,  
the Middle East, or Africa ..... 8-4

Country-Specific Modem Cables ..... 8-5

Using the Modem with a Cellular Phone  
(North America Only) ..... 8-6

    Using PIN Dialing ..... 8-6

    PIN Dialing When Using a Stored Dial Suffix ..... 8-7

    Checking Signal Strength ..... 8-7

    Checking the Phone and Modem Connection ..... 8-7

    Disabling Cellular Phone Recognition ..... 8-8

    Registering the Phone with the Modem ..... 8-9

Modem Compatibility ..... 8-10

*chapter 9*

**ADDITIONAL FEATURES**

Identifying Audio Connections ..... 9-2

Using Internal and External Microphones ..... 9-3

Using Internal and External Speakers ..... 9-4

Controlling Audio Volume ..... 9-5

Infrared Connections ..... 9-6

Types of PC Cards ..... 9-8

Inserting a PC Card ..... 9-9

Removing a PC Card ..... 9-11

Enabling/Disabling PC Card Slots ..... 9-12

PC Card Device Drivers ..... 9-12

Zoomed Video ..... 9-13

Intelligent Manageability ..... 9-13

    Asset Management ..... 9-14

    Changing the Asset Tag Number ..... 9-14

    Fault Management ..... 9-15

    Fault Management Alerts ..... 9-15

    Security Management ..... 9-16

    Configuration Management ..... 9-16

*chapter 10*

**COMPUTER SETUP AND DIAGNOSTICS**

Using Computer Setup.....	10-1
Running Computer Setup .....	10-3
Exiting Computer Setup .....	10-3
Running Computer Checkup (TEST).....	10-4
Running View System Information (INSPECT).....	10-5
Factory Default Settings .....	10-6
Running Compaq Diagnostics .....	10-8

*chapter 11*

**CARE, TRAVEL, AND SHIPPING GUIDELINES**

Caring for the Computer.....	11-1
Operating Temperatures .....	11-2
Traveling with the Computer.....	11-2
Shipping the Computer .....	11-3

*chapter 12*

**TROUBLESHOOTING**

Checklist for Solving Problems.....	12-1
Solving Audio Problems.....	12-2
Solving Battery/Battery Gauge Problems .....	12-4
Solving Compact Disc/CD-ROM Drive Problems.....	12-6
Solving Diskette Drive Problems .....	12-7
Solving Hard Drive Problems.....	12-8
Solving Infrared Problems .....	12-9
Solving Keyboard/Numeric Keypad Problems .....	12-11
Solving Modem Problems .....	12-11
Solving PC Card Problems .....	12-14
Solving Power Problems.....	12-17
Solving Screen Problems .....	12-18
Solving USB Problems .....	12-19



*appendix A*

**APPENDIX TITLE**

Preparing for a Technical Support Call ..... A-1  
Worldwide Telephone Numbers ..... A-2

*appendix B*

**REGULATORY NOTICES** ..... B-1

*appendix C*

**ELECTROSTATIC DISCHARGE**

Preventing Electrostatic Discharge ..... C-1  
    When Handling Removable Drives ..... C-1  
    When Installing Internal Components ..... C-1  
Grounding Methods ..... C-2

*appendix D*

**SPECIFICATIONS** ..... D-1

**INDEX** ..... I-1



# chapter 1

## GETTING STARTED

Before you use your computer for the first time, you will have to complete some preliminary setup procedures. This chapter explains how to set up your computer and software, and how to charge your battery.

This guide has references to the Windows 95 and Windows NT operating systems. If your computer is installed with an alternate operating system, please refer to the supplemental documentation that came with your computer.

### Setting Up the Computer

1. Tilt the computer to access the battery release latch ❶.
2. Slide the battery release latch to eject the battery pack.
3. Pull the battery pack out of the battery bay ❷.

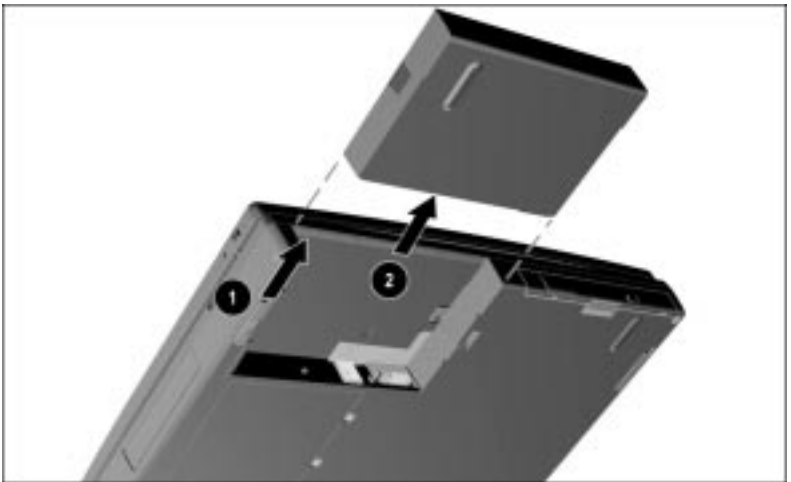

4. Remove the label from the battery pack ❶.
5. Reinsert the battery pack into the battery bay until it clicks into place ❷.

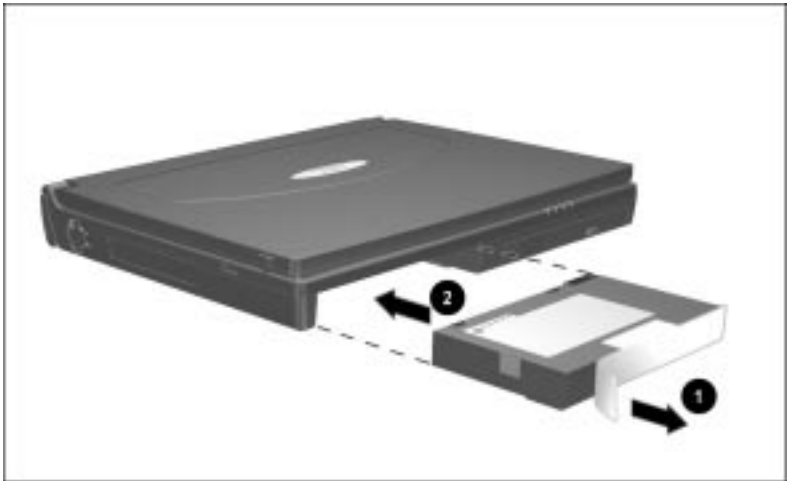

## Charging the Battery Pack for the First Time

The battery pack begins to charge as soon as the computer is connected to external power.

Although a new battery pack can be used to power the computer after receiving a partial charge, Compaq recommends that a new battery pack be allowed to fully charge before the computer is disconnected from external power or before the battery pack is removed from the computer.

**IMPORTANT:** The battery charge level lights on a new battery pack accurately display the percent of a full charge remaining in the battery pack only after the battery has been fully charged.

A new battery pack fully charges in approximately

- 2.5 hours when the computer is connected to external power and not being used.
- 4 hours when the computer is connected to external power and being used.

## Connecting the Computer to AC Power

- ❶ Plug the power cord into the AC Adapter.
- ❷ Plug the AC Adapter cable into the power connector on the back of the computer.
- ❸ Plug the other end of the power cord into an electrical outlet.



**NOTE:** In Japan, you must first plug the power cord into the 3-to-2-prong plug adapter included with the computer. Ensure that the ground wire is connected to a safe earth ground, then plug the 3-to-2-prong plug adapter into the electrical outlet.



**WARNING:** To reduce the risk of personal injury, electric shock, fire, or damage to the equipment:

- Do not disable the power cord grounding plug. The grounding plug is an important safety feature.
- Plug the equipment into a grounded (earthed) electrical outlet that is easily accessible at all times.
- Disconnect power from the equipment by unplugging the power cord from the electrical outlet.
- Do not place anything on power cords or cables. Arrange them so that no one may accidentally step on or trip over them. Do not pull on a cord or cable. When unplugging from the electrical outlet, grasp the cord by the plug.

## Opening the Computer

To open the computer:

1. Slide the two latches located on each side of the display.
2. Lift the display to the desired angle.

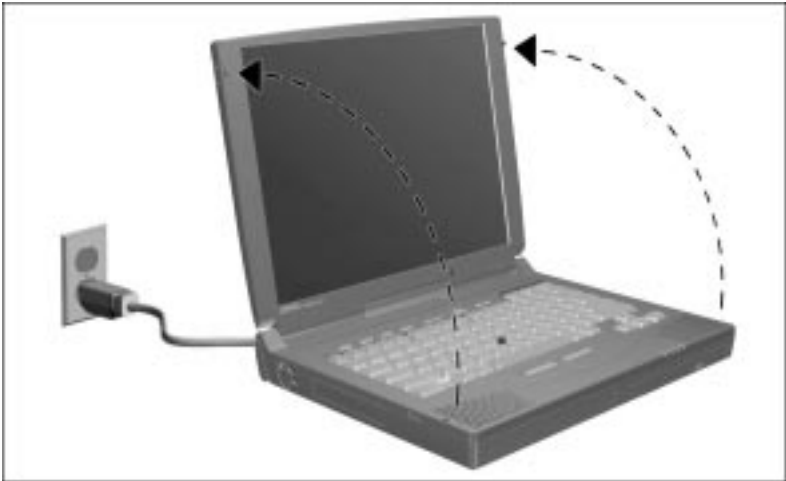
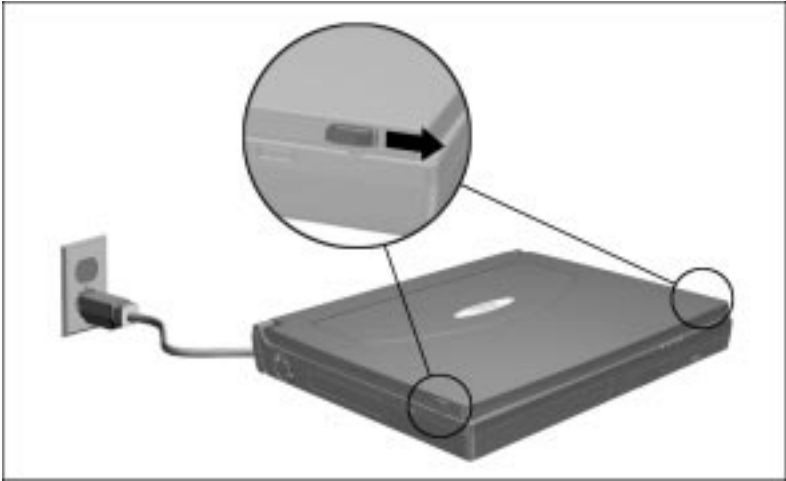

## Turning On the Computer

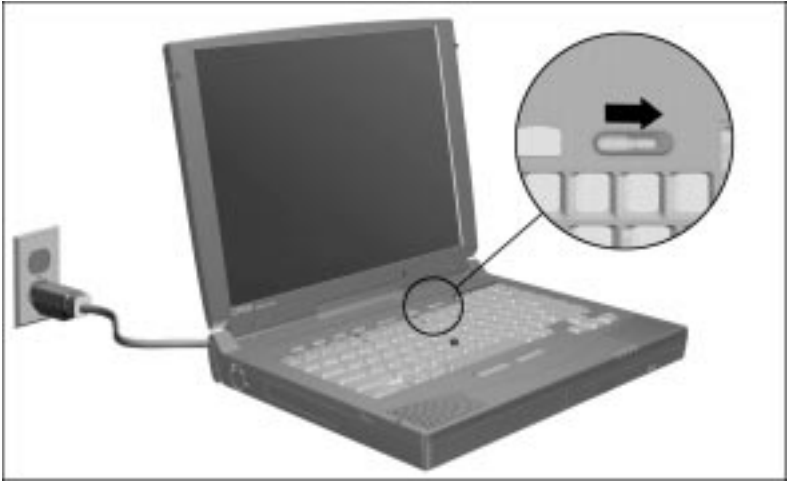

To turn on the computer, slide the power switch and release it.

## Setting Up the Software

When you begin software setup, online instructions guide you through the setup process.

**IMPORTANT:** After you begin software setup, you must complete the entire process, which may require up to 20 minutes. Make sure the computer is plugged into an external power source for this process to ensure that software setup is uninterrupted.



**CAUTION:** To prevent file corruption and ensure the correct software drivers are installed:

- Do not dock the computer in a docking station.
  - Do not turn off or unplug the computer or remove a drive during software setup.
-

## Operating the Computer During Setup

- To move around the screen while making selections and entering information:
  - press the **Tab** key,
  - press the cursor (arrow) keys, or
  - use the pointing device built into the computer keyboard.
- To save your selections, press the **Enter** key or press the left mouse button on the computer keyboard.
- To restore the screen if it is cleared by the screen saver during a period of keyboard and mouse inactivity, press the **Shift** key.

For more information about using the built-in pointing device and mouse buttons, refer to Chapter 3, “Keyboard and Pointing Device.”

## Choosing a Language

If you are prompted to select your language, choose carefully.

**IMPORTANT:** The languages that you do **not** choose will be deleted from the computer and cannot be recovered.



## Removing the Operating System

Either Microsoft Windows 95 or Microsoft Windows NT Workstation is preinstalled on the computer.

Compaq has enhanced the preinstalled operating systems on the computer to provide you with additional software features and increased computer functionality.

Before deleting the operating system preinstalled on the computer, please read the following Caution:



### **CAUTION:**

- Replacing the preinstalled Windows 95 or Windows NT operating system with a retail version will result in the loss of all Compaq enhancements.
  - Most preinstalled reference files, such as Help files, are available only through the Windows 95 or Windows NT interface. If Windows 95 or Windows NT is removed from the computer, these reference files will become unavailable.
  - Complete USB support is available only through Windows 95. Installing an operating system other than Windows 95 may result in a loss of USB functionality.
- 

## Restoring Your Operating System and Software Preinstalled by Compaq

In addition to the operating system, Compaq installs other software to provide additional functionality or enhancements. If it is necessary to reinstall the operating system and you do not want to lose these enhancements, it will also be necessary to reinstall all Compaq software for your computer. Refer to the Compaq Internet site ([www.compaq.com](http://www.compaq.com)) or contact Compaq customer support for more information on this additional software and the various tools available to help reinstall.

# Completing Setup

## Registering the Computer (North America Only)

Be sure to register the computer according to the instructions on the *Register Now* card included with the computer.

## Locating Online Resources

To access the *Reference Guide* online:

- Click Start → Compaq Information Center → Reference Guide  
or
- Click Start → Help → Contents → Reference Guide

# *chapter* 2

## COMPUTER AT A GLANCE

This chapter introduces you to the physical components of your computer. The components are identified individually along with brief descriptions.

### Front Components

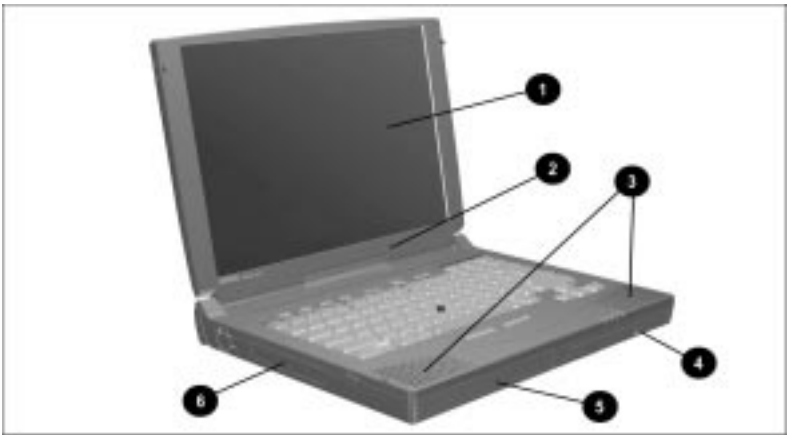

#### Front Components

Component	Description
<b>1</b> display	The monitor that comes attached to the computer.
<b>2</b> microphone	Built-in monophonic microphone for the multimedia sound system.
<b>3</b> built-in stereo speakers	Built-in stereo speakers.
<b>4</b> MultiBay	A multifunction device bay in the computer that supports a removable hard drive, diskette drive, or CD-ROM drive.
<b>5</b> battery bay	Holds the battery pack in the computer.
<b>6</b> hard drive bay	Holds the removable hard drive shipped with the computer.

# Rear Components



## Rear Components

Component	Description
<b>1</b> infrared port	Allows wireless communication between the computer and another infrared-equipped device such as a computer or printer.
<b>2</b> USB port	Allows you to attach the computer to a Universal Serial Bus (USB) device, such as a camera for video. Or you can attach a hub which would allow you to connect multiple USB devices to the computer.
<b>3</b> parallel connector	Connects an optional parallel device such as a printer.
<b>4</b> docking connector	176-pin expansion bus connector that connects the computer to the desktop expansion base or convenience base.
<b>5</b> external monitor connector	Connects an optional external display, such as an external CRT monitor.
<b>6</b> serial connector	Connects an optional external serial device such as a mouse.
<b>7</b> keyboard/mouse connector	Connects an optional full-sized keyboard or a PS/2 compatible mouse. A generic splitter/adaptor will allow the connection of both an external keyboard and external mouse at the same time.
<b>8</b> power connector	Connects the AC Adapter to the computer.

# Left Side Components



---

## Left Side Components

---

Component	Function
<b>1</b> display release latch	Located on either side of the display and used to open the computer. Slide both display latches forward simultaneously to open the computer.
<b>2</b> fan	Airflow exhaust used to keep the internal components of the computer cool. The fan will automatically run when needed.
<b>3</b> hard drive bay	Holds the removable hard drive shipped with the computer.

---

# Right Side Components



## Right Side Components

Component	Description
<b>1</b> stereo speaker/headphone jack	Connects external stereo speakers and headphones to the computer. This jack is driven by an amplifier and has volume control. The internal computer speakers are turned off when external speakers or headphones are plugged into this jack.
<b>2</b> microphone jack	Connects an external monophonic microphone.
<b>3</b> stereo line-in jack	Connects a CD player, tuner, or tape deck to the computer.
<b>4</b> 25-pin connector	Used for connecting a country-specific modem cable to the computer in all countries except those in North America, Latin America, and Japan. (For North America, Latin America, and Japan refer to the <b>RJ-11</b> jack located on the right side of the computer.) The 25-pin connector is also used in the United States only for connecting a cellular phone to the computer.

*Continued*

**Right Side Components** *Continued*

<b>Component</b>	<b>Description</b>
<b>5</b> security slot for lock	A slot for an optional cable lock to secure the computer to a fixed object.
<b>6</b> RJ-11 jack	Used for connecting a standard telephone cable to the computer in North America, Latin America, and Japan. (If this connector is not accessible, you must use a country-specific modem cable with the 25-pin connector.)
<b>7</b> PC Card slots	CardBus (32-bit) slots that support Type I, II, and III PC Cards such as modem cards or network cards. These slots support 16-bit PC Cards as well as CardBus (32-bit) PC Cards.
<b>8</b> display release latch	Located on either side of the display and used to open the computer. Slide both display latches forward simultaneously to open the computer.

# Top Components



## Top Components

Component	Function
<b>1</b> volume control	Controls volume to the built-in stereo speakers. Left button decreases volume, right button increases volume. Also controls volume to external speakers or to headphones plugged into the stereo speaker/headphone jack.
<b>2</b> suspend button	Toggle that initiates or exits Suspend. Turns on the computer if it is off. If the computer is docked in the expansion base, also turns on the expansion base. When used with the <b>Fn</b> key on the computer, initiates Hibernation.
<b>3</b> power switch	Turns the computer on or off, or exits Suspend. When the computer is in Suspend, sliding the power switch exits Suspend but does not turn off the computer.
<b>4</b> Caps Lock light	Indicates that Caps Lock is on, which causes new text to be typed in uppercase letters.

*Continued*



## Top Components *Continued*

<b>Component</b>	<b>Function</b>
<b>5</b> Scroll Lock light	Indicates that Scroll Lock is on, which causes the cursor to scroll by fields rather than by lines.
<b>6</b> Num Lk light	Indicates that Num Lk is on and that the embedded numeric keypad is enabled.
<b>7</b> display switch	Turns off the display if the display is closed while the computer is still on. If warning beeps are enabled in Computer Setup, a beep will sound if the display is closed when the computer is on.
<b>8</b> built-in stereo speakers (2)	Built-in stereo speakers.
<b>9</b> MultiBay drive light	Green light that indicates when a MultiBay device is being accessed.
: battery power light	Turns on when a battery pack in the computer is charging. Turns off when the battery pack is fully charged. Blinks to indicate a low battery condition.
<b>11</b> hard drive light	Green light that indicates when the hard drive is being accessed.
<b>12</b> power/suspend light	Turns on when power is turned on. Turns off when power is turned off. Flashes to indicate the computer is in Suspend.
<b>13</b> left and right mouse buttons	Press the left and right mouse buttons in conjunction with the EasyPoint III pointing device to initiate an action or confirm a selection.
<b>14</b> EasyPoint III pointing device	Provides mouse functions with all software that supports a Microsoft-compatible mouse.
<b>15</b> Programmable Keys	Four user-programmable keys used to quickly open an application on your computer, bring up a document, or emulate one of the Microsoft Windows and Application Logo Keys.

# Bottom Components

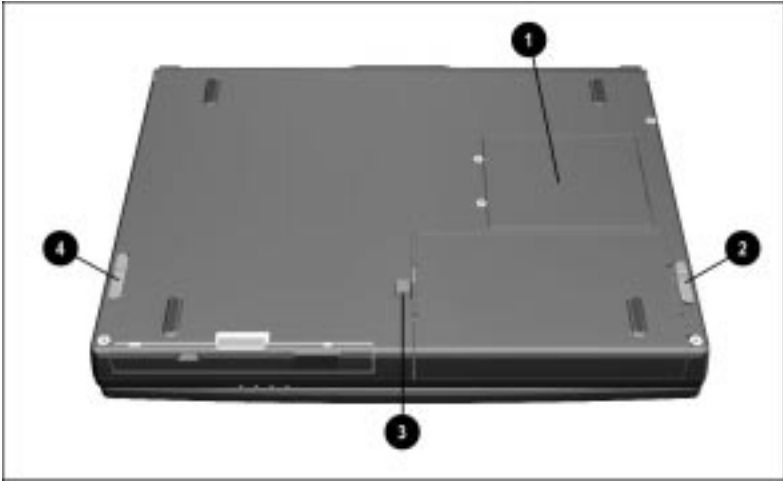

## Bottom Components

Component	Description
<b>1</b> memory expansion slot cover	This cover must be removed in order to install an optional memory expansion board.
<b>2</b> battery release latch	Releases the battery pack from the battery bay.
<b>3</b> docking restraint latch recess	Helps to secure the computer to the desktop expansion base.
<b>4</b> MultiBay release latch	Releases a removable hard drive, CD-ROM drive, or diskette drive from the MultiBay.

## Adjusting the Computer Using the Tilt Feet

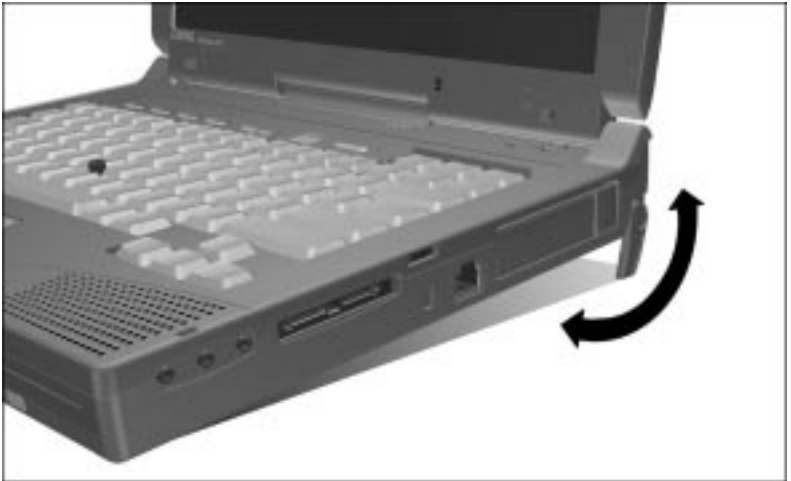

The computer has a tilt feature that allows you to adjust the angle of the keyboard for maximum comfort.

To adjust the angle, flip open the tilt feet located on the bottom of the computer until they lock in place. Close the tilt feet to return the keyboard to a horizontal plane.



# chapter 3

## KEYBOARD AND POINTING DEVICE

You can maneuver through applications on your computer using the keyboard, pointing device, or a combination of both. This chapter explains how to maximize the benefits of each of these features.

# Keyboard Components

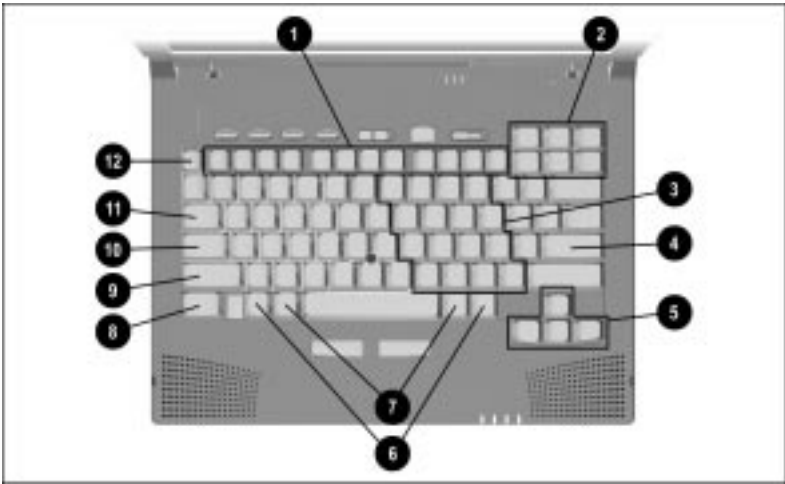

- ❶ Function keys (F1-F12)
- ❷ Screen control keys
- ❸ Embedded numeric keypad
- ❹ Enter key
- ❺ Cursor keys
- ❻ Ctrl keys
- ❼ Alt keys
- ❽ Fn key
- ❾ Shift key
- ❿ Caps Lock key
- ⓫ Tab key
- ⓬ Esc key

# Programmable Keys

## Using Programmable Keys

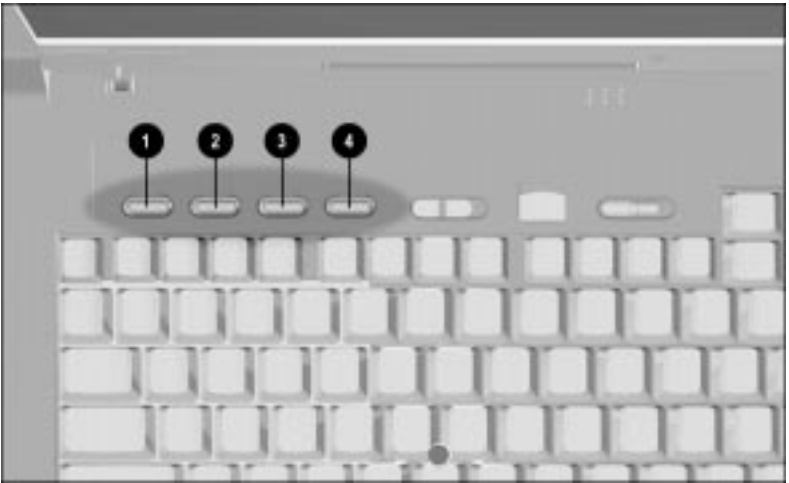

- ❶ first programmable key
- ❷ second programmable key
- ❸ third programmable key
- ❹ fourth programmable key

You can set the four programmable keys to quickly open an application on your computer, bring up a document, or emulate one of the Microsoft Windows and Application Logo keys.

By assigning the programmable keys to schemes, you can create multiple sets of key assignments to tailor your computer for various uses or accommodate more than one user.

## Assigning Programmable Keys

To assign or reassign an application to a programmable key, do the following:

1. Access the Programmable Keys utility by clicking Start → Settings → Control Panel → Keyboard → Programmable Keys.
2. Select the programmable key you wish to assign or reassign for the current scheme by clicking its radio button in the Key assignments box.
3. Click the Assign button.

A dialog box appears displays the list of programs or documents from the Programs menu.

**NOTE:** To access a larger number of programs, click Show Advanced Options. This changes the Assign button to the Browse button. By clicking the Browse button, you can access all applications on your computer. To emulate one of the Microsoft Windows and Application Logo keys, open the PROGRAM FILES\ COMPAQ\PROGRAMMABLE KEYS directory.

4. Highlight the application you want and click OK.
5. The icon and program name you selected appear beside the programmable key's button.
6. Click OK to exit the utility.
7. When you press the programmable key you have just assigned, your application or document appears on screen.



## Unassigning Programmable Keys

To remove a programmable key assignment, do the following:

1. Access the Programmable Keys utility.
2. Select the programmable key you wish to unassign by clicking the appropriate button in the Key assignments group box.

**NOTE:** To unassign keys in other than the current scheme, click Show Advanced Options and select a different scheme. If you have never created a scheme, the Default scheme is the only choice.

3. Click the Assign button, then select Unassigned from the list. The icon and program name previously assigned to the key are removed.

**NOTE:** When the Show Advanced Options checkbox is checked, you can unassign a programmable key by clicking the Browse button and selecting the file 'Unassigned' from the following directories:

PROGRAM FILES\COMPAQ\PROGRAMMABLE KEYS  
95\DEFAULT

or

PROGRAM FILES\COMPAQ\PROGRAMMABLE KEYS  
NT\DEFAULT

4. Click OK to exit the utility.

## Adding Schemes

Schemes are a collection of up to four programmable key assignments that you define to your Windows user profile. You can create multiple, unique schemes. For example, you can create a scheme called Home that contains key assignments for programs you use at home, and a scheme called Work for programs that you use at work.

To add a new scheme, do the following:

1. Access the Programmable Keys utility.
2. Place a check in the Show Advanced Options checkbox if one is not already there.
3. Click the Add button.

4. Type the name of your new scheme in the popup dialog box that appears.
5. Make your programmable key assignments.
6. When the assignments have been made, click OK to exit the utility.

## Removing Schemes

To remove a scheme, do the following:

1. Access the Programmable Keys utility.
2. Place a check in the Show Advanced Options checkbox if one is not already there.
3. Be sure the scheme in the Scheme box is the one you want to delete. To view a different scheme, select a scheme from the drop-down list.

**NOTE:** The Default scheme is not removable.

4. Click the Remove button.
5. Click OK to exit the utility.

## Showing the Key Assignments in the System Tray

One convenient way to see your programmable key assignments is to view them in a popup window that you activate from an icon in the system tray.

To enable the icon, do the following:

1. Access the Programmable Keys utility.
2. Place a check in the Show Key Assignments in the System Tray checkbox.
3. Click OK to exit the utility.

An icon appears in the system tray. To view the popup window, click the icon.

**NOTE:** The icon remains in the system tray until you disable it by unchecking the Show Key Assignments in the System Tray checkbox or by right-clicking the icon and choosing Exit from the menu.

# Hotkeys

---

## Hotkey Quick Reference

---

Function	Hotkeys	Return to Original State
Switching Displays	<b>Fn+F4</b>	<b>Fn+F4</b>
Adjusting System Warning Beeps	<b>Fn+F5</b>	<b>Fn+F5</b>
Initiating QuickLock/ QuickBlank	<b>Fn+F6</b>	Enter power-on password
Accessing Power Management	<b>Fn + F7</b>	<b>Fn + F7</b>
Accessing the Battery Gauge	<b>Fn + F8</b>	<b>Fn + F8</b>
Accessing the Brightness Controll	<b>FN+F10</b>	<b>FN+F10</b>
Accessing the Embedded Numeric Keypad	<b>Fn+NumLk</b>	<b>Fn+NumLk</b>
Stretching Text	<b>FN+T</b>	<b>FN+T</b>

You can move the hotkey popup window location by pressing **Fn+F1**.

**NOTE:** Hotkeys work only on the computer keyboard and not on an external keyboard.

If you are running Windows 95, use the Hotkey Popup utility to change the display size and location of the Hotkey Popups. (To access the Hotkey Popup Utility, click Start → Settings → Control Panel → Hotkey Popup.)

### Switching Displays

When an external monitor is connected to the computer, press the **Fn+F4** hotkeys as a toggle function to

- Switch to computer display.
- Switch to external monitor.
- Turn on both displays simultaneously.

### Adjusting System Warning Beeps

Press the **Fn+F5** hotkeys to adjust the volume for system warning beeps. To increase volume, press **Fn+F5**, then the right arrow key. To decrease volume, press **Fn+F5**, then the left arrow key.

## Initiating QuickLock/QuickBlank

**IMPORTANT:** Before QuickLock/QuickBlank can be initiated, a power-on password must be established and QuickLock/QuickBlank must be enabled through Computer Setup.

Press the **Fn+F6** hotkeys to initiate QuickLock/QuickBlank at any time and from within any application. This hotkey

- Disables the keyboard and the pointing device.
- Clears the display.

To reenable the keyboard and return your information to the screen, enter your power-on password.

## Accessing Power Management

Press the **Fn+F7** hotkeys to access Power Management. This hotkey lets you customize the level of battery conservation, or use one of the three preset conservation levels.

Use the left or right arrow keys to select a different level.

## Accessing the Battery Gauge

Press the **Fn+F8** hotkeys to show the status of the battery packs. Three numbered boxes indicate the status of each installed battery:

- **Battery 1**—primary battery in the computer battery bay
- **Battery 2**—battery in the MultiBay of the expansion base or the battery charging bay of the convenience base
- **Battery 3**—battery in the half-height bay (with MultiBay Adapter) of the expansion base

Press the right or down arrow key to view the status of the next battery pack. If a battery pack is not in a bay, the corresponding bay cannot be selected. Press the left or up arrow key to select the previous battery pack.

## Accessing the Brightness Control

Press the **Fn+F10** hotkeys to adjust the display brightness. Press the right arrow key to increase light intensity; press the left arrow key to decrease light intensity.

## Accessing the Embedded Numeric Keypad

The embedded numeric keypad is a section of the computer keyboard that converts to a numeric keypad when the number lock function is enabled.

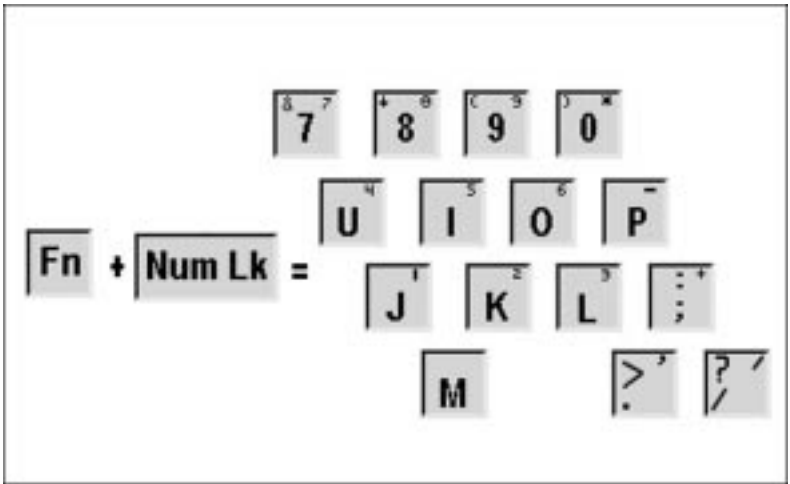

Press **Fn+Num Lk** to:

- Enable the embedded numeric keypad (Num Lk light on).
- Disable the embedded numeric keypad (Num Lk light off).

With the number lock function enabled:

- Press **Fn** to type lowercase letters.
- Press **Fn + Shift** to type uppercase letters.

## Stretching Text

When running MS-DOS under Windows, the image on the computer display may not fill the screen.

To stretch text so that it fills more of the screen, use the **Fn+T** keys. Toggle these keys to switch between stretched text mode and regular mode. The default is for Text Stretch to be on.

The **Fn+T** function is available whenever the desktop area resolution is set lower than the resolution of the internal display device (LCD).

## Using the Pointing Device

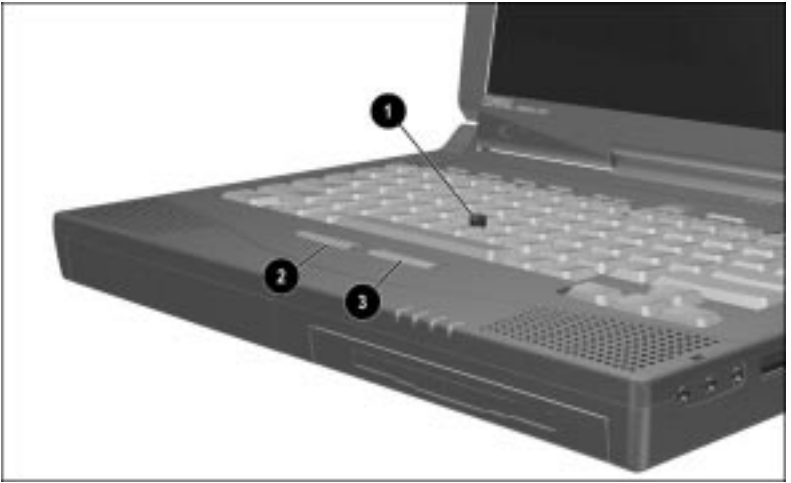

The pointing device performs the same basic operation as a mouse. The EasyPoint III senses finger movement; the device itself does not move.

To operate the pointing device:

1. Place your index finger on top of the pointing device **1**.
2. Push in the direction you want the cursor to move on the display.
3. Click the left **2** or right **3** mouse button with your thumb.

## Replacing the Pointing Device Cap

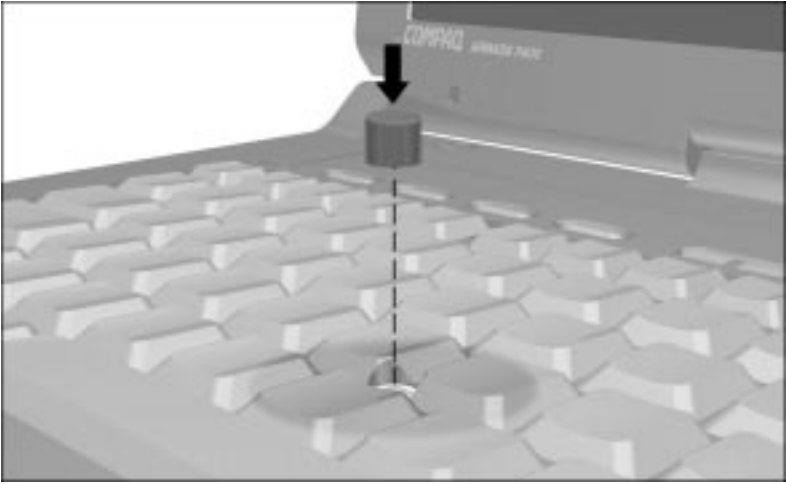

Two spare pointing device caps were shipped with your computer. If you need to replace the cap:

1. Shut down the computer or exit all applications.
2. Gently pull off the cap.
3. Gently push on the new cap.

**NOTE:** If the plastic portion underneath the cap comes off, gently push it back on.



# chapter 4

## BATTERY PACKS

Your computer can be powered by the included battery pack or an external power source. The battery pack gives you the freedom to carry your computer from place to place while you work, without plugging the computer into an external outlet each time.

This chapter identifies the battery components and provides useful information about using the battery pack.

# Battery Components

The lithium ion (Li-ion) battery pack lets you check the remaining charge level before you insert it into the battery bay.

To see how much power is left in the battery pack, press the battery gauge **1**. Five battery charge level lights **2** indicate the remaining charge level.

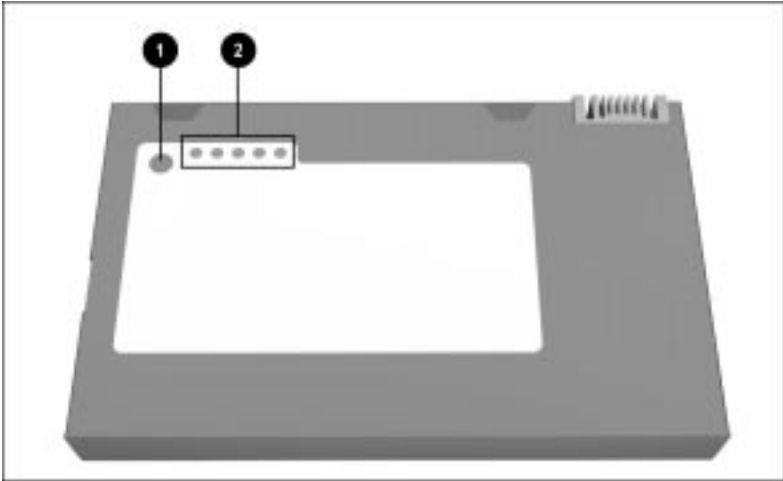

Each battery charge light represents approximately 20 percent of remaining charge. If two lights are on, approximately 40 percent charge remains. If all five are on, the battery is fully charged.

## Charging Battery Packs

If the battery pack has not been used for two weeks or more, fully charge the battery before using your computer.

To charge the battery pack in the computer, connect the computer to an external power source (optional Automobile/Aircraft Adapter, external AC Adapter, ArmadaStation, Armada MiniStationE/EX, or battery charger).

The battery power light turns on when the battery pack is charging.

Charging may not occur immediately if:

- The battery pack temperature is outside the normal operating range of 50°F to 104°F (10°C to 40°C).
- The battery pack is below normal discharge levels, which can occur when a battery pack is not used for 2 weeks or more.

When the battery reaches the normal temperature and charge level, it begins to charge until it is fully charged.

A fully discharged battery pack charges in approximately 3 hours when the computer is turned off. When the computer is turned on, charge time depends on the amount of power being used by the computer.

## Ensuring Battery Gauge Accuracy

The built-in battery gauge displays the amount of charge remaining and is precalibrated for accuracy (To access the battery gauge press **Fn+F8**). To ensure continued battery gauge accuracy and to maximize battery operating time:

- Fully charge and discharge the battery pack completely several times prior to the first time that you use it.
- Allow the battery pack to completely charge before removing external power from the computer, optional ArmadaStation, Armada MiniStation E/EX, or battery charger.
- Recharge the battery pack before using it if the battery has been out of the computer for two weeks or more.
- Allow the battery to completely discharge to the low battery condition through normal use.

## Identifying a Low Battery Condition

When a low battery condition occurs, the computer beeps every 15 seconds and the battery power light blinks.



**CAUTION:** When you are alerted to a low battery condition, very little battery charge remains. Take immediate action to resolve the low battery condition.

---

When a low battery condition is reached, save your files and initiate Suspend. You have approximately 10 minutes to resolve the low battery condition before the computer enters the critical low battery condition.

When a critical low battery condition occurs, the system initiates Hibernation. It is recommended that Hibernation is enabled at all times to safeguard against possible data loss in a critical low battery condition.



**CAUTION:** If Hibernation is disabled, the computer does not initiate Hibernation when a critical low battery condition is reached. If Hibernation is disabled, the computer initiates Suspend until the battery pack fully discharges. When this occurs, all unsaved data is lost.

---

## Resolving a Low Battery Condition

The following sections show how to resolve a low battery condition:

- Connecting to an electrical outlet
- Connecting to the Optional Automobile/Aircraft Adapter
- Replacing the battery pack
- Initiating Hibernation or turning off the computer until a power source is available

## Connecting to an Electrical Outlet

- 1 Plug the power cord into the AC Adapter.
- 2 Plug the AC Adapter cable into the power connector on the back of the computer.
- 3 Plug the other end of the power cord into an electrical outlet.



**NOTE:** In Japan, you must first plug the power cord into the 3-to-2-prong plug adapter included with the computer. Ensure that the ground wire is connected to a safe earth ground, then plug the 3-to-2-prong plug adapter into the electrical outlet.



**WARNING:** To reduce the risk of personal injury, electric shock, fire, or damage to the equipment:

- Do not disable the power cord grounding plug. The grounding plug is an important safety feature.
- Plug the equipment into a grounded (earthed) electrical outlet that is easily accessible at all times.
- Disconnect power from the equipment by unplugging the power cord from the electrical outlet.
- Do not place anything on power cords or cables. Arrange them so that no one may accidentally step on or trip over them. Do not pull on a cord or cable. When unplugging from the electrical outlet, grasp the cord by the plug.

## Connecting to the Optional Automobile/Aircraft Adapter

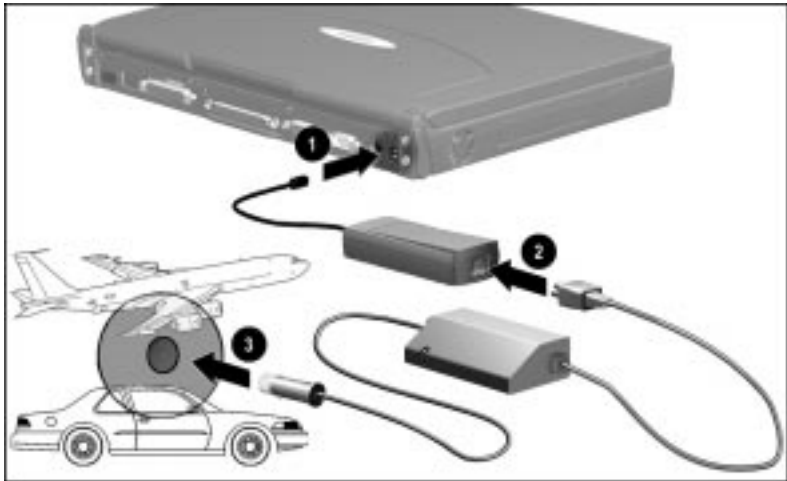

To charge the battery pack by connecting to the optional Automobile/Aircraft Adapter:

- 1** Connect the external AC Adapter cable to the rear of the computer.
- 2** Connect the pronged end of the external AC Adapter to the optional Automobile/Aircraft Adapter.
- 3** Plug the optional Automobile/Aircraft Adapter into the cigarette lighter or into the in-seat power supply on an aircraft.

**IMPORTANT:** Leaving the computer connected to the vehicle with the optional Automobile/Aircraft Adapter for an extended period of time when the vehicle is off may deplete the vehicle battery. Depletion occurs regardless of whether the computer is turned on or off.

## Resolving a Low Battery Condition by Replacing the Battery Pack



**CAUTION:** If you are removing the battery pack while the computer is on, you can prevent loss of information by initiating Suspend before removing the battery pack. Be sure to replace the discharged battery pack with a charged one within 10 minutes.

---

Stop working and save your work immediately.

1. Press the suspend button to initiate Suspend.
2. Wait until the power/suspend light flashes.
3. Remove the discharged battery pack.
4. Insert a fully charged battery pack.
5. Press the suspend button again to exit Suspend.
6. Continue your work.

## Resolving a Low Battery Condition with No Power Sources Available

To resolve a low battery condition when no power sources are available, select one of these methods:

- Initiate Hibernation until a power source is available
- Turn off the computer until a power source is available

# Removing the Battery Pack from the Battery Bay



**CAUTION:** Always initiate Suspend or turn off the computer prior to removing the battery. Removing the battery without initiating Suspend when the system is powered on could result in data loss. If Suspend is initiated, be sure to insert a charged battery pack within 10 minutes.

---

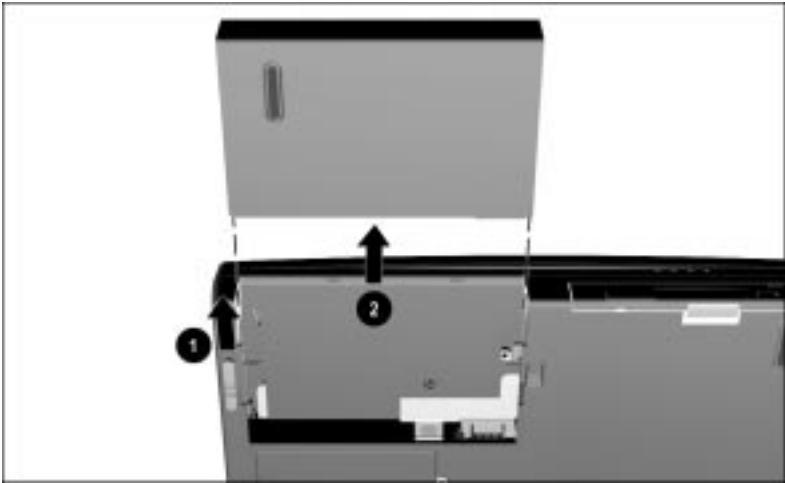

1. If the computer is turned on, turn it off or press the suspend button. If there is hard drive or diskette activity, Suspend may not occur instantly.
2. Tilt the computer at an angle so you can see the bottom of the computer.
3. Slide the battery release latch **1** on the bottom of the computer.
4. Remove the battery pack **2** .



## Inserting the Battery Pack into the Battery Bay

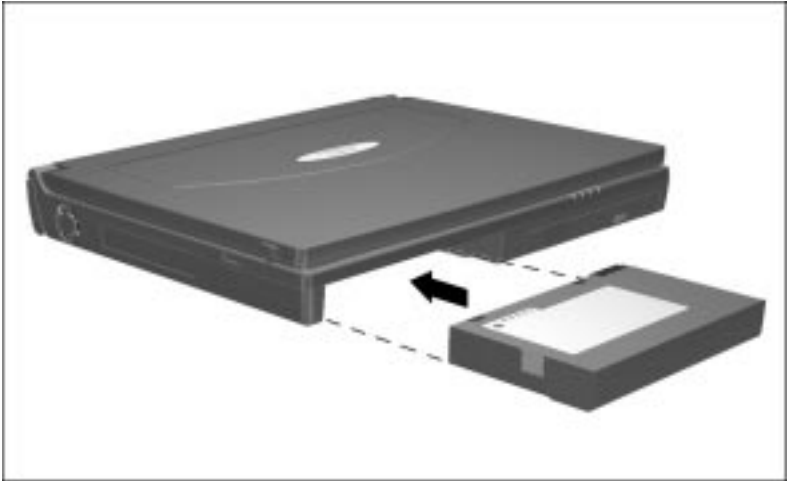

1. Insert the battery pack into the battery bay with the large label on the battery pack facing up.
2. If the computer is in Suspend, press the suspend button to resume normal operation.

## Storing Battery Packs

When storing the computer for more than two weeks, remove battery packs and store them separately to reduce the discharge rate and increase battery life.

Battery packs self-discharge even when they are not being used. The rate of self-discharge is affected by temperature. To prolong the battery charge of a stored battery pack, store it in a cool, dry place. High temperatures cause a battery pack to lose its charge more quickly, thus reducing battery life.

The recommended storage temperature range is from  $-4^{\circ}\text{F}$  to  $86^{\circ}\text{F}$  ( $-20^{\circ}\text{C}$  to  $30^{\circ}\text{C}$ ).



**CAUTION:** To prevent damage to a battery pack, do not expose it to high temperatures for extended periods of time.

---

# Maximizing Battery Life

Battery pack operating time varies depending on the system components, options, and applications being used. You can maximize battery operating time by controlling the energy required by the computer and the energy stored in the battery pack.

The display, processor, CD-ROM drive, and hard drive components use the majority of battery power.

To notify you that the display is closed and the computer is still on, the computer beeps three times every two seconds.

To turn off the beeps without turning off the computer:

1. Open the computer.
2. Initiate Suspend by pressing the suspend button.

The beeps stop and the computer begins conserving battery power.

To maximize battery pack life:

- Remove battery packs to reduce the discharge rate when the computer is not to be used for more than two weeks.
- Select the High level of power management via F10 setup.
- Initiate Suspend or Hibernation or turn off the computer when not in use.
- Reduce the display brightness and select a shorter screen save timeout.
- Avoid frequent partial charge and discharge cycles which reduce the life of the battery. Fully charge and discharge the battery periodically to maintain the accuracy of the battery gauge.
- Keep a battery pack in the computer when connected to an AC power source.
- Disconnect external equipment that does not have its own power source when not in use. (External equipment connected to the computer drains the battery pack.)
- Exit modem programs when not in use.
- Remove any PC Cards when not in use.
- Store an unused battery pack in a cool, dry place. The recommended storage temperature range is from -4°F to 86°F (-20°C to 30°C). High temperatures cause a battery pack to lose its charge more quickly and reduce battery pack life.
- Format diskettes using external power. (Formatting increases battery pack drain.)

## **Recycling Used Battery Packs**

To find out if the battery pack recycling program is available in your geographical location, check the worldwide telephone numbers. If a number for recycling is not listed for your area, contact your Compaq authorized dealer, reseller, or service provider



# chapter 5

## COMPUTER POWER AND POWER MANAGEMENT

This chapter provides helpful information on maintaining and managing battery pack power. You also will find useful information about the Suspend and Hibernation features.

### Leaving On the Computer

When you need to leave your computer unattended but you don't want to turn it off, conserve power by initiating Suspend. Always put your computer in Suspend when a battery pack is your only power source. With a fully charged battery pack, Suspend conserves battery life.

**NOTE:** Frequent discharge/recharge cycles shorten battery pack life.

### Turning Off the Computer

To turn off the computer:

1. Save open files.
2. Shut down the computer.

The Start → Shut Down command will close all applications and automatically power off the system. This eliminates the need to slide the power switch.

**NOTE:** If you plan to store the computer for two weeks or more, remove the battery pack from the computer battery bay. This reduces the battery discharge rate and extends battery pack operating life.

# Managing Power

The computer comes standard with a collection of power management features that allow you to extend battery operating time and conserve power.

Use power management to monitor most of the computer components such as the hard drive, processor, and display. When a component is inactive for a specified period of time, called a timeout, you can use power management settings to shut it down temporarily. Refer to the section, “Timeout,” later in this chapter.

## Accessing Power Management

Click Start → Settings → Control Panel → double-click Power to view or set the following in Power Properties.

<b>If You Want To:</b>	<b>Click This Tab:</b>
Show Suspend on the Start menu or battery meter on the taskbar	Power (Windows 95 only)
Set timeouts for drives when using battery power or AC power	Disk Drives (Windows 95 only)
Turn off power to the PC Card slots	PC Card Modems (Windows 95 only)
Enable/disable Energy Saver and customize Energy Save monitor values	AC Energy Saver (Windows NT only)
Set battery conservation levels; enable/disable warning beeps; set timeouts	Battery Conservation Settings
Select Hibernation settings; set Hibernation timeout	Hibernation
Display the status of installed batteries	Battery Status
Set date and time to exit Suspend; enable/disable Resume Timer	Resume Timer

# Power Management Levels

To extend the life of your batteries, use the Battery Conservation tab in Power Properties. You can customize the level of battery conservation or use one of four power management levels:

- **High**—Select this level for the maximum amount of power conservation possible in an automatic setting. Using this level, you receive the most battery operating time from a single charge.
- **Medium**—Select this level for a balance between performance and battery operating time. This is the default setting.
- **Custom**—Select this level to customize timeout settings for:

## Windows 95

Suspend  
System idle  
Screen save  
Processor speed  
Brightness

## Windows NT

Suspend  
Hard disk idle  
System idle  
Screen save  
Processor speed  
Brightness

**NOTE:** The custom level default settings are the same as the medium level until you set your own values.

- **None (Drain)**—Provides the maximum battery drain because battery conservation is turned off. The computer runs at full speed if power conservation level is set to none.

## Setting the Power Management Level with Power Properties

You can change the default levels of battery conservation through the Conservation Settings tab in Power Properties located in the Control Panel. Choose a preset level or customize your own. The level you set remains in effect until you change it.

## Setting the Power Management Level with Computer Setup

You can also set Power Management using Computer Setup.

1. Run Computer Setup.
2. Click the System Features icon.
3. Click the Power Management box.
4. Click the Battery Conservation tab.
5. Select a battery conservation level.
6. Click OK.

## Suspend

### Benefits of Using Suspend

- Puts the computer to sleep for up to one week with a fully charged lithium-ion battery pack.
- Uses very little power.
- Saves your place in your applications.
- Shuts down most major components such as hard drive, processor, and display.

When you initiate Suspend, system information is saved in random access memory (RAM).



## Initiating Suspend

Suspend can be initiated by the user or by the system (computer).

- User-initiated Suspend:
  - Initiates Suspend anytime by pressing the suspend button.

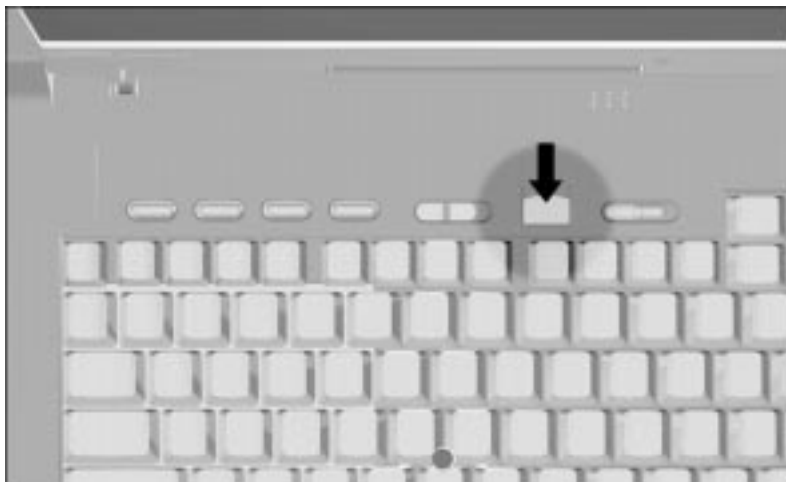

- Initiates Suspend by clicking Suspend from the Windows Start menu.
- System-initiated Suspend:
  - Initiates after five minutes or a user-selected timeout during normal battery operations.
  - Initiates when the system reaches a critical low battery condition and Hibernation has been disabled.



**CAUTION:** If Hibernation is disabled, the computer does not initiate Hibernation when a critical low battery condition is reached. If Hibernation is disabled, the computer initiates Suspend until the battery pack fully discharges. When this occurs, all unsaved data is lost.

---

**NOTE:** When you close the display while the computer is on, the screen clears, but the computer IS NOT in Suspend.

When Suspend is initiated, the:

- Screen clears.
- Power/suspend light blinks.
- Computer beeps (six times if system initiated, twice if user initiated).

**NOTE:** During Suspend the screen is blank. However, unlike a powered-off state, the computer turns back on when the suspend button is pressed.

## Exiting Suspend

- If Suspend was initiated because the timeout expired, exit by pressing the suspend button once or sliding the power switch.
- If Suspend was initiated because Hibernation has been disabled and the system reaches a critical low battery condition, exit Suspend in one of these ways:
  - Connect the computer to the external AC Adapter and connect to AC power, or
  - Connect the computer to the external AC Adapter connected to the optional Automobile/Aircraft Adapter, or
  - Dock the computer in the optional ArmadaStation or Armada MiniStation E/EX, or
  - Replace the battery pack, then press the suspend button or slide the power switch.

When you exit Suspend, the computer:

- Beeps twice.
- Power/suspend light stops blinking and remains lighted.
- Returns previously displayed information to the screen.

**NOTE:** When you exit Suspend, your information returns to the screen at the point where Suspend was initiated. No information is lost provided you do not lose battery power while the computer is in Suspend.

# Hibernation

Hibernation is a safeguard condition in which all information in system memory is saved to the hard drive and power to the computer is turned off. When you resume your work, your information is returned to the screen exactly where you left off.

## Benefits of Using Hibernation

- When Hibernation is initiated, no information is lost. There is no limit to the amount of time the computer can remain in Hibernation, since the computer is turned off and there is no drain on the battery pack.
- Hibernation can be used as a placemaker. For example, it is useful when you're making a presentation away from the office. You can do all the preparation in advance, mark your place by initiating Hibernation, and be ready to make your presentation as soon as you arrive.
- Hibernation is a safeguard feature that saves information should the computer reach a critical low battery condition while it is left unattended.

## Initiating Hibernation

Hibernation can be initiated by the user or by the system (computer).

**NOTE:** Hibernation cannot be initiated when the computer is docked in the ArmadaStation or Armada MiniStation E/EX.

- User-initiated Hibernation occurs when you press **Fn** and the suspend button simultaneously. These keys can be pressed at any time and from anywhere within an application.
- System-initiated Hibernation occurs when:
  - The computer is turned on and left unattended, and a critical low battery condition occurs.
  - The Hibernation timeout occurs.



**CAUTION:** If Hibernation is disabled, the computer does not initiate Hibernation when a critical low battery condition is reached. If Hibernation is disabled, the computer initiates Suspend until the battery pack fully discharges. When this occurs, all unsaved data is lost.

---

**NOTE:** Batteries that have not been fully charged may not have enough power to support a system-initiated Hibernation at critical low battery.

When the system initiates Hibernation, it

- Clears the screen.
- Saves all current information in memory to the hard disk.
- Turns off the computer.

## Enabling/Disabling Hibernation

Hibernation is automatically enabled when you first set up your computer. It is recommended that you enable Hibernation at all times to safeguard against possible data-loss in a critical low battery condition. In order for Hibernation to work, it must allocate space on your hard drive equal to the amount of random access memory (RAM) installed. To free up disk space, you can disable Hibernation.

To disable Hibernation, click Start → Settings → Control Panel → Power Management → Hibernation tab → off.

To enable Hibernation, click Start → Settings → Control Panel → Power Management → Hibernation tab → on.

**NOTE:** If you upgrade memory, the computer increases the Hibernation file size to accommodate the additional RAM. When the Hibernation file increases, it requires more hard disk space.

## Exiting Hibernation

Select one of the following methods:

- If Hibernation was user-initiated or a low battery condition has been resolved, slide the power switch to turn on the computer.
- If the computer is in a critical low battery condition, insert a fully charged battery pack or connect an external power source.

The computer exits Hibernation. The information saved to the hard disk returns to the screen at the point where Hibernation was initiated.

**NOTE:** To stop the restoration of information, press **Fn+Ctrl+Break**.

## Timeout

A timeout is a specified period of inactivity for the computer or its components. After this time period passes, power management shuts down the computer or its components to save battery power. For example, the hard drive component and default timeout is two minutes. Therefore, if a software application does not access information on the hard disk for two minutes, the hard drive spins down until it is accessed again.

Timeouts work with power management to conserve battery power. Battery power can be conserved by

- Using timeouts that correspond with the preset medium (default) or high level of power conservation.
- Using the custom level of power conservation to set your own timeouts so that they work more efficiently with your applications.

## Setting Component Timeouts

You can set your own timeout values for individual components of the computer. To set component timeouts, use the following procedure:

1. Access the Power Properties utility.
2. Click the Battery Conservation Settings tab.
3. Set the Battery Conservation level to Custom.
4. Using the drop-down boxes, select or type a timeout value for specific components of the computer, such as system idle and hard disk idle.
5. To save your settings, click OK when you are done. They become effective immediately and remain in effect until you change them.

## Setting the Screen Saver Timeout

1. Click the right mouse button anywhere on the desktop.
2. Click on Properties.
3. Click on the Screen Saver tab.
4. Select a screen saver.
5. Set the Custom timeout.
6. Click OK.

# *chapter* 6

## REMOVABLE DRIVES

As you use your computer, you will store all of your data on some type of drive which may include the following removable drives:

- Hard drive
- CD-ROM drive
- Diskette drive

Your computer is equipped with a convenient MultiBay, which allows you to use the same drive bay for each of the above drives (at separate times).

This chapter describes the features of each removable drive and drive adapter.

### Using Removable Drives

The computer has two bays for removable drives:

- A hard drive bay that supports only a hard drive.
- A MultiBay that supports a diskette drive, CD-ROM drive, or, with an adapter, a second hard drive.

The Armada 7300/7400 Hard Drive MultiBay Adapter is required to use a hard drive in the computer MultiBay.

# Caring for Removable Drives

Removable drives (hard drive, CD-ROM drive, diskette drive) are fragile computer components that must be handled with care.



**CAUTION:** To prevent damage to the computer, removable drive, or loss of information, observe the following precautions.

---

- Back up the hard drive before removing it. Failure to back up the hard drive can result in loss of information stored on the drive if it is handled improperly.
- If there is a diskette or CD in a drive, remove it prior to removing the drive from the computer.
- Do not remove a CD-ROM drive while the CD-ROM drive drawer is open. Before removing the drive, ensure that the drive drawer is fully closed.
- Turn off the computer before removing or inserting a hard drive.
- Ensure that you are discharged of static electricity before handling a removable drive. Electrostatic discharge can damage electronic components. When handling a removable drive, always grasp the outer case and avoid touching the connectors. Do not use force when inserting a drive into a bay. Excessive force may damage the connectors.
- Carefully handle the removable drive. **DO NOT DROP IT.**
- Avoid exposing a hard drive to products with magnetic fields such as video and audio tape erasure products, monitors, and speakers.
- Do not spray the drive with cleaners or expose it to liquids.
- Avoid exposing the drive to temperature extremes.
- If a drive must be mailed, ship it in a suitable form of protective packaging. Shipping the drive in standard packaging may not cushion it from destructive shock, vibration, temperature, or humidity. Place a mailing label with the wording “Fragile: Handle With Care” on the mailer.



# MultiBay Weight Saver

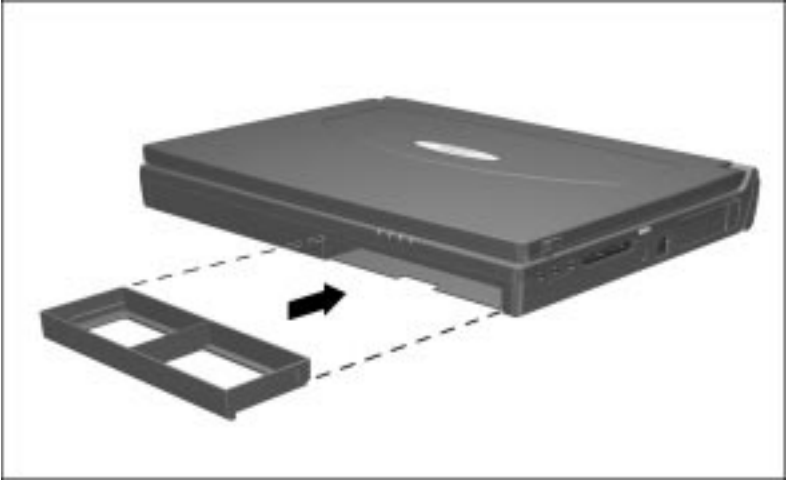

When no device is needed in the computer MultiBay, you can insert the MultiBay weight saver to reduce computer weight and to cover the MultiBay opening.

## Handling Drives

Please observe the following caution when handling any of your removable drives:



**CAUTION:** To prevent damage to the computer and drive, and loss of information, turn off the computer before removing the hard drive, CD ROM drive, or diskette drive from the hard drive bay or MultiBay. Do not remove a drive while the computer is turned on, in Suspend, or in Hibernation.

Electrostatic discharge can damage electronic components. Before touching a drive, ensure that you are discharged of static electricity by touching a grounded metal object.

---

# Hard Drives

## Removing a Hard Drive from the Hard Drive Bay

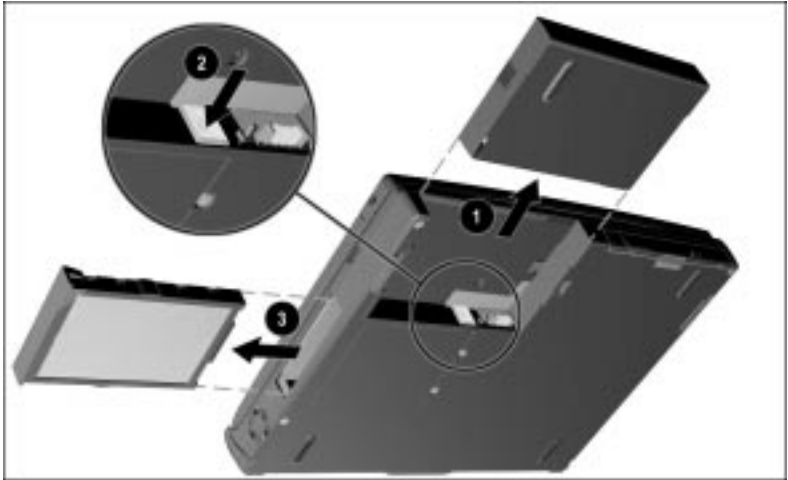

As a precautionary measure, Compaq recommends that you back up all information on the hard drive.

Close the display and proceed with the following steps:

1. Save your work, exit all applications, and turn off the computer.
2. Remove the battery from the battery bay ❶.
3. Eject the hard drive by pushing the button located in the empty battery bay ❷.
4. Pull the hard drive from the hard drive bay ❸.

## Inserting a Hard Drive into the Hard Drive Bay

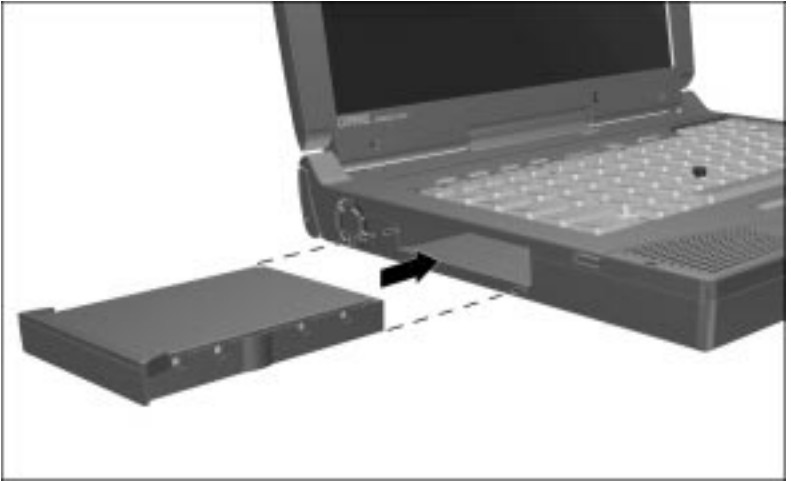

1. Turn off the computer.
2. Place the hard drive in the hard drive tray.
3. Slide the hard drive tray into the hard drive bay until it clicks into place.

## Removing a Hard Drive from the MultiBay

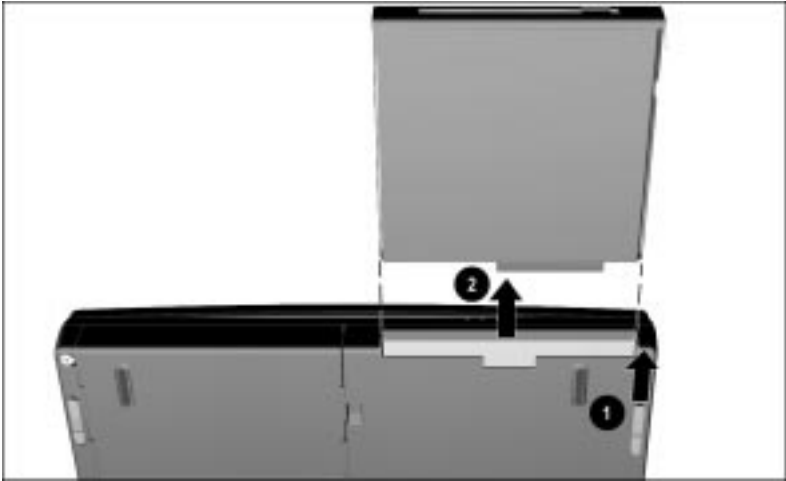

1. As a precautionary measure, Compaq recommends that you back up all information on the hard drive.
2. Turn off the computer.
3. Tilt the computer at an angle so you can see the bottom front of the computer.
4. Slide the MultiBay release latch toward the front of the computer ❶ to release the Armada 7300/7400 Hard Drive MultiBay Adapter which houses the hard drive.
5. Pull out the Hard Drive MultiBay Adapter and hard drive ❷.

## Inserting a Hard Drive into the MultiBay

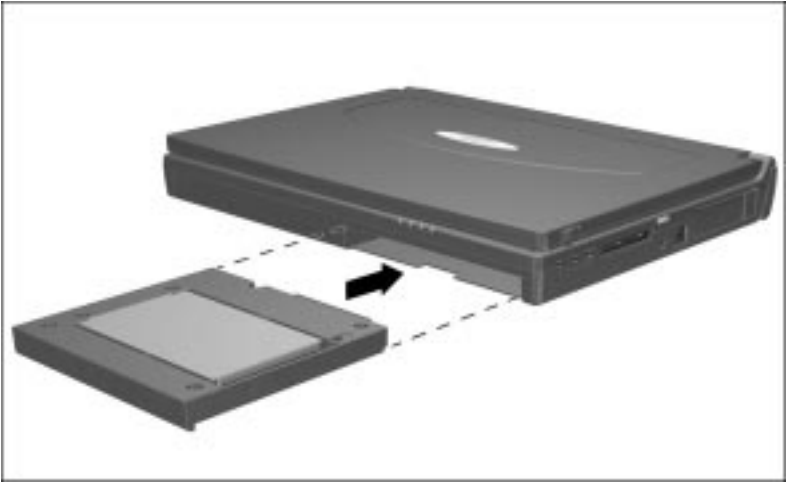

1. Turn off the computer.
2. If the hard drive was previously located in the dedicated hard drive bay, remove the hard drive from the hard drive tray.
3. Insert the hard drive into the Armada 7300/7400 Hard Drive MultiBay Adapter with the hard drive label facing down.
4. Position the hard drive carrier against the left side of the MultiBay
5. Slide the Hard Drive MultiBay Adapter in until it locks into place.

# CD-ROM Drives

## Removing the CD-ROM Drive from the MultiBay

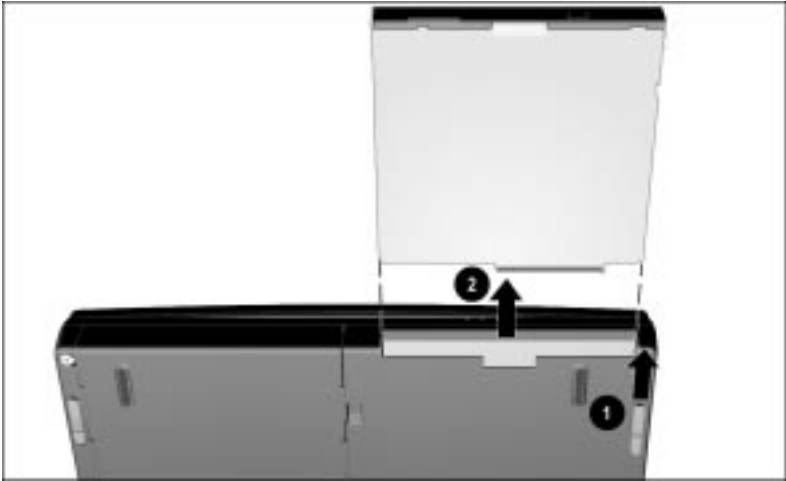

1. Remove any compact discs from the CD-ROM drive.
2. Close the CD tray.
3. Turn off the computer.
4. Tilt the computer at an angle so you can see the bottom front of the computer.
5. Slide the MultiBay release latch toward the front of the computer ❶ to release the CD-ROM drive from the MultiBay.
6. Pull out the CD-ROM drive ❷.

**NOTE:** With Windows NT as preinstalled by Compaq, you are able to remove the CD-ROM drive with the computer on or in suspend. If you installed Windows NT on your own, you must ensure that all Compaq Windows NT software enhancements are installed. Otherwise, this functionality is not supported.

## Inserting the CD-ROM Drive into the MultiBay

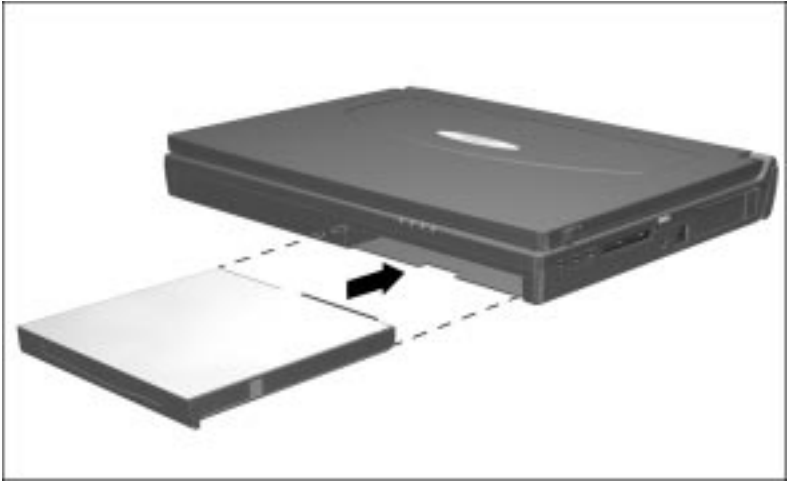

1. Turn off the computer.
2. Position the CD-ROM drive against the left side of the MultiBay with the drive label facing up.
3. Slide the CD-ROM drive into the MultiBay until it locks into place.

**NOTE:** With Windows NT as preinstalled by Compaq, you are able to insert the CD-ROM drive with the computer on or in suspend. If you installed Windows NT on your own, you must ensure that all Compaq Windows NT software enhancements are installed. Otherwise, this functionality is not supported.

## Working with Compact Discs

### Inserting a Compact Disc into the CD-ROM Drive

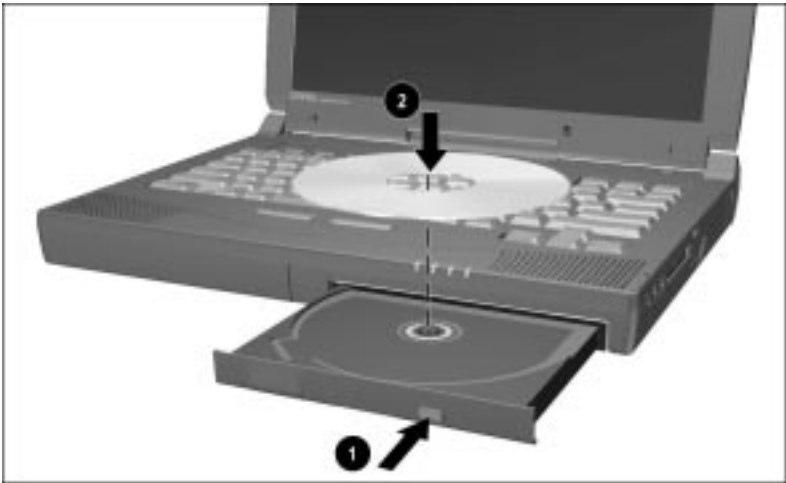

1. Turn on the computer.
2. Press the eject button on the front panel ❶ to release the CD tray.
3. Slowly pull out the CD tray until it is fully extended.
4. Remove the CD from its protective case and place it in the CD tray, label side up ❷. Handle the CD by the edges, not by the flat surfaces
5. Push lightly on the front panel of the CD loading tray to close it.

The CD-ROM drive performs a diagnostic check and automatically begins reading the table of contents (TOC) on the CD. The light on the CD-ROM drive turns on while the TOC is being read. The light turns off when the CD-ROM drive is ready to receive commands.



## Removing a Compact Disc from the CD-ROM Drive

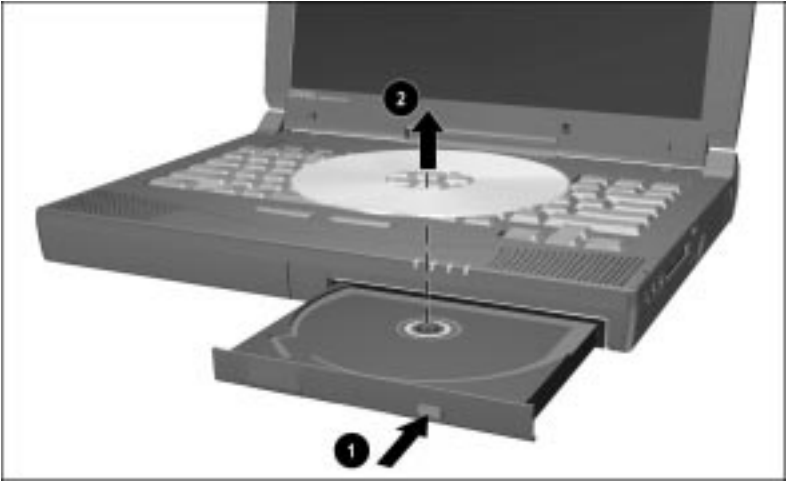

1. Turn on the computer.
2. Press the eject button on the front panel ❶ to open the CD tray.
3. Slowly pull out the CD tray until it is fully extended.
4. Remove the CD from the tray ❷. Handle the CD by the edges, not by the flat surfaces.
5. Place the CD in its protective case.
6. Push the front panel of the CD tray to close it.

# Diskette Drives

## Removing the Diskette Drive from the MultiBay

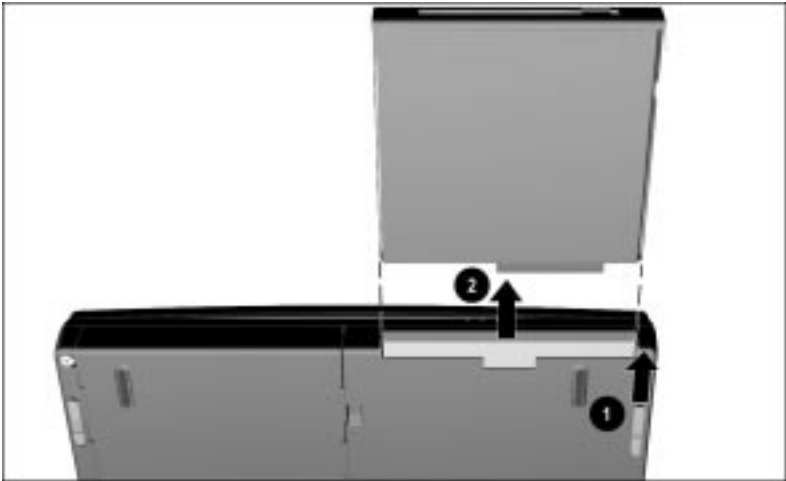

1. Remove the diskette from the diskette drive.
2. Turn off the computer.
3. Tilt the computer at an angle so you can see the bottom front of the computer.
4. Slide the MultiBay release latch toward the front of the computer ❶ to release the diskette drive from the MultiBay.
5. Pull out the diskette drive ❷.

**NOTE:** With Windows NT as preinstalled by Compaq, you are able to remove the diskette drive with the computer on or in suspend. If you installed Windows NT on your own, you must ensure that all Compaq Windows NT software enhancements are installed. Otherwise, this functionality is not supported.

## Inserting the Diskette Drive into the MultiBay

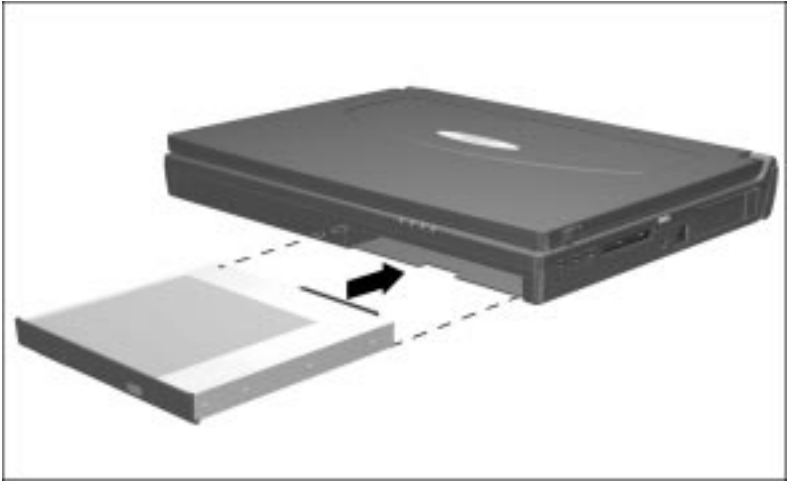

1. Turn off the computer.
2. Position the diskette drive against the left side of the MultiBay with the diskette drive label facing up.
3. Slide the diskette drive into the MultiBay until it locks into place.

**NOTE:** With Windows NT as preinstalled by Compaq, you are able to insert the diskette drive with the computer on or in suspend. If you installed Windows NT on your own, you must ensure that all Compaq Windows NT software enhancements are installed. Otherwise, this functionality is not supported.

## Working with Diskettes

### Selecting Diskettes

The diskette drive stores (writes) information to and reads information from a 3.5-inch diskette.

You can use the following diskette capacities: 1.44 megabytes, 720 kilobytes, 1.2 megabytes.

<b>Diskette capacity and type:</b>	<b>Storage capacity in text pages:</b>
1.44-MB high-density (HD)	Approximately 250 full pages
1.2-MB high-density (HD)	Approximately 200 full pages
720-KB double-density (DD)	Approximately 125 full pages

## Inserting a Diskette into the Diskette Drive

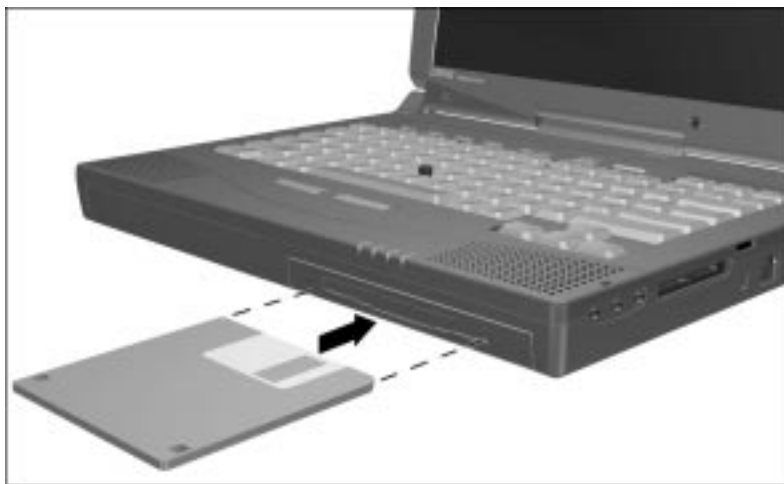

1. Hold the diskette by the edge that contains the label, diskette label facing up.
2. Gently push the diskette into the diskette drive until it clicks into place.

The diskette drive button ejects to show the diskette is inserted correctly.

## Removing a Diskette from the Diskette Drive

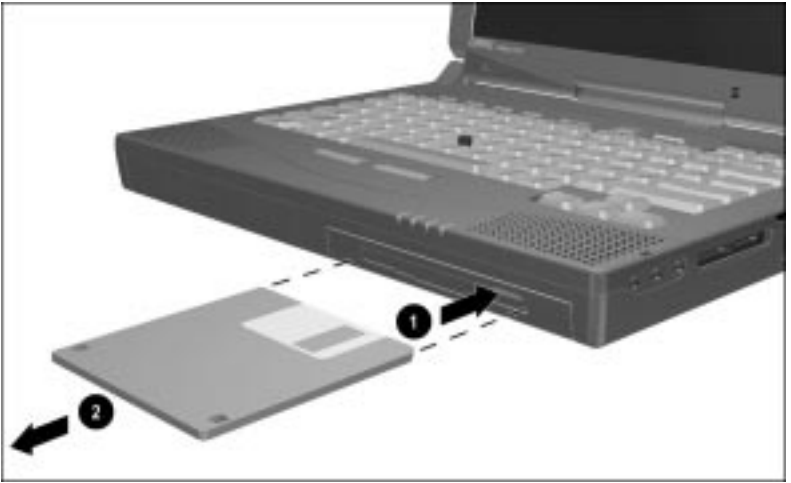

- 1 Press the diskette drive button to eject the diskette.
2. Remove the diskette from the diskette drive.



# *chapter* 7

## SECURITY

Your computer has security features which prevent unauthorized users from accessing your drives. This chapter describes each of these security features.

### **Types of Security**

Security features protect your computer and the information stored on it from unauthorized access.

- **DriveLock**

Prevents unauthorized use of the hard drive when the computer is turned on, restarted, or resumed from Hibernation. It stops an unauthorized user from using your hard drive.

- **Power-On Password**

Prevents unauthorized use of the computer when it is turned on, restarted, or resumed from Suspend or Hibernation.

- **Setup Password**

Prevents unauthorized users from changing your computer configuration through Computer Setup. May also be used by network administrators to protect and access the configuration of computers in a network.

- **QuickLock/QuickBlank**

Clears the screen and disables the keyboard and other input devices while the computer is running.

- Login Password (Windows NT only)

Used to log in to Windows NT. When combined with the previously mentioned security features, prevents unauthorized users from accessing your hard drive.
- Disabling devices through Computer Setup

Prevents unauthorized use of specified computer components.
- Security screws

Help prevent unauthorized removal of memory expansion boards and hard drives.

**NOTE:** A security kit, which includes security screws and installation instructions, comes with your computer.
- Cable lock provision

Provides a way to secure the computer, optional desktop expansion base, or optional convenience base to a fixed object.

## DriveLock

### Overview

DriveLock security prevents unauthorized access to hard drive applications and user data. DriveLock sets a user password and a master password for each removable hard drive in the computer.

**NOTE:** DriveLock password protects or unlocks the computer hard drive(s) only when inserted into either the hard drive bay or the MultiBay. Do not use DriveLock if you want to use a hard drive in the desktop expansion base or convenience base. If you place a protected hard drive into the ArmadaStation or Armada MiniStation E/EX MultiBay, it will remain locked and cannot be accessed.

The correct user password must be entered when the computer is turned on before a protected hard drive can be accessed. The owner of a user password should be the day-to-day user of the hard drive. The user password will be required even if the hard drive is inserted into another computer.

The master password is used to remove DriveLock protection and to gain access to the hard drive instead of the user password. The owner of the master password may be the system administrator.



## Establishing DriveLock Protection

---



**CAUTION:** Forgetting or losing both the user and master passwords will render the protected hard drive permanently unusable. Record your master password and keep it in a secure location physically separate from your computer. In the event you lose the user password, the master password can be used to unlock a protected hard drive and reset the user password.

---

1. Run Computer Setup. (See the section “Running Computer Setup” in Chapter 10.)
2. Click the System Features icon → Security Management box → DriveLock tab.
3. In the Current Drive section, select either hard drive bay or MultiBay.
4. In the Drive Protection section, click Set to establish DriveLock protection for the selected hard drive.
5. Read the warning message. If you wish to continue, click OK.
6. In the Set User Password section, enter your new user password. (You may use up to 32 alphanumeric characters, and you may use the same password you are using for the power-on password.)
7. Enter the user password again to verify it.
8. Click OK.
9. In the Set Master Password section, enter your new master password. (You may use up to 32 alphanumeric characters, and you may use the same password you are using for the power-on password.)
10. Enter the master password again to verify it.
11. Click OK.
12. Read the warning message. If you wish to establish DriveLock, type **DriveLock** at the prompt.
13. Click OK.

**NOTE:** Type carefully because the passwords do not display as you type them.

The changes will take place when you exit Computer Setup. You will be prompted to enter your user password the next time you boot your computer using that hard drive.

## Entering the DriveLock Password

When the DriveLock password prompt displays, enter your user password.

If you type the user password incorrectly, you are prompted to reenter it up to two times. After two unsuccessful attempts to unlock a protected hard drive, you must restart the computer.

## Changing the User Password

If you forget your user password, you can access your removable hard drive with the master password. Record the user and master passwords and keep them physically separate from the computer.

Once you create a user password, you can only change the password after the computer has restarted and the protected hard drive has been unlocked.

1. Turn on or restart the computer and enter your current user password.
2. Run Computer Setup.
3. Click the System Features icon → Security Management box → DriveLock tab.
4. In the Current Drive section, select either hard drive bay or MultiBay.
5. In the User Password section, click Change.
6. Type the old user password.
7. Enter your new user password. (You may use up to 32 alphanumeric characters, and you may use the same password you are using for the power-on password.)  
**NOTE:** Type carefully because the password does not display as you type it.
8. Enter the password again to verify it.
9. Click OK.

## Changing the Master Password

Once you have enabled DriveLock protection and established user master passwords, you can only change the password after the computer has restarted and the protected hard drive has been unlocked.

1. Turn on or restart the computer and enter your current user password.
2. Run Computer Setup.
3. Click the System Features icon → Security Management box → DriveLock tab.
4. In the Current Drive section, select either hard drive bay or MultiBay.
5. In the Master Password section, click Change.
6. Type the old master password.
7. Enter your new master password. (You may use up to 32 alphanumeric characters, and you may use the same password you are using for the power-on password.)  
**NOTE:** Type carefully because the password does not display as you type it.
8. Enter the password again to verify it.
9. Click OK.

## Removing DriveLock Protection

Once you have enabled DriveLock protection and established user and master passwords, you can only delete the passwords after the computer has restarted and the protected hard drive has been unlocked. Removing DriveLock protection deletes both the user password and the master password.

1. Turn on or restart the computer and enter your current user password.
2. Run Computer Setup.
3. Click the System Features icon → Security Management box → DriveLock tab.
4. In the Current Drive section, select either hard drive bay or MultiBay.
5. In the Drive Protection section, click Remove.
6. Enter the master password.
7. Enter the master password again to verify it.
8. Click OK → Save and Exit.

The changes will take place when you exit Computer Setup.

## Power-On Password

### Using the Power-On Password

After you set the power-on password, you must enter it each time you turn on or restart the computer or resume from Suspend or QuickLock/QuickBlank.

When the power-on password prompt displays, enter your power-on password.

If you type the password incorrectly, you are prompted to reenter it up to three times.

## Setting the Power-On Password Using Windows 95/NT

The power-on password prevents unauthorized use of the computer when it is turned on, restarted, or resumed from Suspend or Hibernation.

To set the power-on password:

1. Click the Computer Security tab in Passwords Properties.
2. Click the Set button.
3. Enter your password twice.
4. Click OK.

**NOTE:** Type carefully because the password does not display as you type it.

The password is not case sensitive. However, you must use the same keys each time you enter the password. For example, the numbers at the top of the keyboard are not recognized as being the same numbers in the embedded numeric keypad.

The next time you restart the computer, you are prompted to enter your power-on password.

## Setting the Power-On Password Using Computer Setup

The power-on password prevents unauthorized use of the computer when it is turned on, restarted, or resumed from Suspend or Hibernation.

To set the power-on password:

1. Run Computer Setup.
2. Click the System Features icon.
3. Click the Security Management menu.
4. Under Power-On Password, click Set.
5. Enter your new power-on password. (You may use up to eight alphanumeric characters, and you may use the same password you are using for the setup password.)
6. Enter the password again to verify it.
7. If you want to require entry of a password whenever the computer is turned on, enter an X next to Enable Password to Power-On.
8. Click OK.
9. Click Exit.
10. Click the Save option.

Once the power-on password is set, you must enter it every time you turn on or restart the computer or resume from Hibernation, Suspend, or QuickLock/QuickBlank.

## Changing the Power-On Password



**CAUTION:** *You cannot use the computer if you forget your power-on password. Record the password and put it in a safe place.*

---

Once you create a power-on password, you can only change the password after the computer has restarted and you are prompted to enter the current power-on password.

To change your password, type in the old password, then enter the new password in the following format:

**current password, keyboard password symbol, new password, keyboard password symbol, new password**

Refer to “Change/Delete Password Symbols” later in this chapter.

## Deleting the Power-On Password

Once you create a power-on password, you can only delete the password after the computer has restarted and you are prompted to enter the current power-on password.

Once you have entered the current power-on password, you can delete it from the computer keyboard. The keyboard symbol for deleting the power-on password varies according to the language of the keyboard purchased with the computer.

To delete your password, type in the old password and the keyboard password symbol, then press **Enter**.

Refer to “Change/Delete Password Symbols” later in this chapter.

## Setup Password

### Using the Setup Password

After you establish the setup password, you must enter it each time you want to change the computer configuration.

If you enter the password incorrectly, you are prompted to reenter it.

**NOTE:** The setup password can be used in place of the power-on password.

## Setting the Setup Password

The setup password prevents unauthorized users from changing your computer configuration through Computer Setup. Setup passwords may also be used by network administrators to protect and access the configuration of computers in a network.

**NOTE:** After you establish the setup password, you must enter it each time you want to change the computer configuration.

1. Run Computer Setup.
2. Click the System Features icon.
3. Click the Security Management box.
4. Under the Setup Password section on the Passwords tab, click Set.
5. Enter your new setup password. (You may use up to eight alphanumeric characters, and you may use the same password you are using for the power-on password.)
6. Enter the password again to verify it.
7. Click OK.
8. Click Exit.
9. Click Save.

**NOTE:** You will be prompted to enter your setup password the next time you try to change the computer configuration using Computer Setup.

Type carefully because the password does not display as you type it.



**CAUTION:** *You cannot change the computer configuration if you forget your setup password. Record the password and put it in a safe place.*

---



## Changing the Setup Password

Once you create a setup password, you can only change the password after the computer has restarted and you are prompted to enter the current setup password.

To change your password, type in the old password, then enter the new password twice, typing the syntax for your computer keyboard between the passwords.

For example, if you have a Belgian keyboard, type the following:

**current password=new password=new password**

The new password takes effect the next time you turn on your computer.

## Deleting the Setup Password

Once you create a setup password, you can only delete the password after you press **F10** to get to Computer Setup and you are prompted to enter the current setup password.

Once you have entered the current setup password, you can delete it using the computer keyboard. The keyboard symbol for deleting the setup password varies according to the language of the keyboard purchased with the computer.

To delete your password, type in the old password and the keyboard password symbol, then press **Enter**.

## Change/Delete Password Symbols

Once you create a setup or power-on password, you can only delete that password after the computer has restarted and you are prompted to enter the current password.

Once you have entered the current setup or power-on password, you can change or delete that password. The keyboard symbol for changing or deleting the setup or power-on password varies according to the language of the keyboard purchased with the computer.

The following is the list of countries and keyboard symbols for changing or deleting the setup and power-on passwords.

<b>Country Keyboard</b>	<b>Keyboard Symbol</b>
Belgian	= (equal sign)
Danish, German, Italian, Latin American, Norwegian, Portuguese, Spanish, Swedish/Finnish, Swiss, Taiwanese	_ (underscore)
French	! (exclamation point)
French/Canadian	é
Japanese, Korean, United Kingdom, United States	/ (slash)

## Quick Controls

### Using the Quick Controls

The Quick Controls establish security measures on your computer when it is on but not in use. They are located in Passwords Properties and Computer Setup.

- QuickLock disables your keyboard and pointing device while the computer is running. It leaves your information on the screen but prevents it from being accessed until a power-on password is entered to enable the keyboard.
- QuickBlank, used in conjunction with QuickLock, clears the screen when the keyboard and pointing device are disabled.
- QuickLock on Suspend automatically disables the keyboard and pointing device when the computer enters Suspend. It prevents your information from being accessed until a power-on password is entered. Entering the password allows the computer to exit Suspend and enables the keyboard and pointing device.

## Enabling and Disabling QuickLock/QuickBlank Using Windows 95/NT

QuickLock/QuickBlank must be enabled before you can initiate the QuickLock/QuickBlank feature with the **Fn+F6** hotkeys. QuickLock/QuickBlank remains enabled until you disable it.

To enable or disable QuickLock/QuickBlank using Windows 95/NT:

1. Access Passwords Properties.
2. Click the Computer Security tab.
3. Under the Quick Controls section, click in the box to enable/disable QuickLock, QuickBlank, or QuickLock on Suspend. An **X** in the box indicates that QuickLock/QuickBlank is enabled.

## Enabling and Disabling QuickLock/QuickBlank Using Computer Setup

QuickLock/QuickBlank must be enabled using Computer Setup before you can initiate the QuickLock/QuickBlank feature with the **Fn+F6** hotkeys. QuickLock/QuickBlank remains enabled until you disable it.

To enable or disable QuickLock/QuickBlank using Computer Setup:

1. Run Computer Setup.
2. Click the System Features icon.
3. Click the Security Management menu.
4. On the Password Options tab, click Enable QuickLock. An **X** in the box indicates that QuickLock is enabled.
5. Click OK.
6. Click Exit.
7. Click the Save option.

## Disabling and Enabling Devices

Computer Setup provides a way to disable devices such as the diskette drive, diskette drive boot ability, serial port, infrared port, parallel port, and PC Card slots. Disabling these devices prevents the unauthorized transfer of data using these devices

To disable or enable a device:

1. Run Computer Setup.
2. Under the View menu, select either View by Type or View by Connection.
3. Click the icon for the device you want to disable.
4. Select the tab for the device you want to disable or enable. An **X** indicates that the selected device is disabled.
5. Click OK.
6. Click Exit.
7. Click Save.

Changes take effect when you restart the computer.

## Using the Cable Lock



The security slot accommodates a cable lock so that the computer can be physically secured to a work area.

1. Loop the cable around a heavy, fixed object to which you want to secure the computer.
2. Insert the cable lock end of the cable through the loop end of the cable.
3. Insert the lock into the security slot.
4. Lock with the key.

**NOTE:** The cable lock can be purchased from Kensington Microwave Limited or Compaq authorized dealers, resellers, and service providers worldwide. Ask for the Kensington MicroSaver Security System, Model 64068.



# *chapter* 8

## INTERNAL MODEM

Your computer may include an integrated modem. Availability varies by model and geographic region. This chapter gives information about the preinstalled modem software, how to connect the modem in different geographical regions, and how to connect a supported cellular phone in North America.

If your computer does not have an integrated modem, Compaq offers a selection of PC card modem options that are compatible with your computer.

### Modem Overview

The modem serves two major functions:

- **Data communications function**—Sends information to and receives information from an online service, a host mainframe computer that provides electronic mail, and other personal computers.
- **Facsimile (fax) communications function**—Sends and receives text and images from facsimile (fax) machines and other computers.

After you set up your software, you are ready to start using your modem. You will hardly ever need to use the AT command set if you are using communications and fax software. The modem will be controlled by the software. In the rare event that you do need to use the AT command set, you can access the information through the Compaq Internet site at [www.compaq.com/support/portables](http://www.compaq.com/support/portables).

# Using Modem Software

Communications software operates the internal modem. This software issues commands to the modem, instructing it how and when to perform tasks such as dialing a number or answering a call.

For Windows 95 and Windows NT 4.0, applications will access data and fax capabilities of the modem via the standard Windows modem interface (Unimodem). In addition, Windows 95 applications, which are TAPI-compliant, may access the modem's speakerphone functions.

If prompted by the communications software to select a modem, choose the Armada 7000 Series II Modem. If this selection is not available, you should select COM3 as the communications port associated with the modem, then choose a Hayes compatible generic modem for the driver.

**NOTE:** Choosing another modem will not affect the actual DCE speed of the modem.

If your software requires specific modem settings, the following information may be required when setting up the modem for operation:

COM port setting	COM3
DCE Speed	33.6 Kbps
DTE Speed	57.6 Kbps
Data Format	Databits - 8
Data Format	Parity - N
Data Format	Stopbits - 1
Dial Command	ATDT
AutoAnswer Command	ATS0 = 1
Sound	Enabled
Columns	80
Local Echo	Enabled



## Connecting the Modem in North America, Latin America, or Japan

**IMPORTANT:** You may use your modem in other countries after connecting a country-specific modem cable to the 25-pin connector on the right side of the computer. Refer to “Country-Specific Modem Cables” later in the chapter for information about purchasing a country-specific modem cable.

The telephone connector (RJ-11) that came with your modem is intended for an analog line, the type found connected to a standard telephone wall jack. If you are in an office, the analog line is often the one connected to a fax machine or modem. To get an analog line in a hotel, request a room with a data line.

**NOTE:** This modem is equipped with Digital Line Guard, a feature that protects the modem if it is accidentally plugged into a digital PBX system with too much power on the line. If the modem is plugged into a digital line and the power detected on the line would damage the modem, the following error message is displayed on the screen:

**DIGITAL LINE NO DIALTONE**

If the modem is plugged into a digital line and the power detected on the line would not damage the modem, the modem will time out and the following error message will be displayed on the screen:

**NO DIALTONE**

You do not have to turn the computer off or place it in Suspend to connect the modem.

To connect the modem to a standard telephone wall jack in North America, Latin America, or Japan:

1. Connect the standard telephone cable into the RJ-11 jack on the right side of the computer.
2. Plug the opposite end of the telephone cable into a standard telephone wall jack.

# Connecting the Modem in Europe, the Middle East, or Africa

**IMPORTANT:** The modem cable included with the computer is approved for a specific country. If you plan to travel with the computer, refer to “Country-Specific Modem Cables” in the next section for information about purchasing additional country-specific modem cables.

**NOTE:** This modem is equipped with Digital Line Guard, a feature that protects the modem if it is accidentally plugged into a digital PBX system with too much power on the line. If the modem is plugged into a digital line and the power detected on the line would damage the modem, the following error message is displayed on the screen:

**DIGITAL LINE NO DIALTONE**

If the modem is plugged into a digital line and the power detected on the line would not damage the modem, the modem will time out and the following error message will be displayed on the screen:

**NO DIALTONE**

You do not have to turn the computer off or place it in Suspend to connect the modem.

To connect the modem to a standard telephone wall jack in Europe, the Middle East, or Africa:

1. Connect the country-specific modem cable to the 25-pin connector on the right side of the computer.
2. Connect the opposite end of the cable to a standard telephone wall jack.

# Country-Specific Modem Cables

When traveling, use the following international modem cables for approved connections in other countries.

**NOTE:** To ensure safe and reliable operation, use only UL LISTED modem cables.

<b>Country</b>	<b>Part Number</b>	<b>Country</b>	<b>Part Number</b>
Australia	234407-013	Luxembourg	234407-183
Austria	234407-343	Netherlands	234407-333
Belgium	234407-183	New Zealand	234407-AP3
Denmark	234407-083	Norway	234407-093
France	234407-053	Sweden	234407-103
Finland	234407-353	Switzerland	234407-113
Germany	234407-043	United Kingdom	234407-033
Japan	234407-293	United States	234407-003

## Using the Modem with a Cellular Phone (North America Only)

To place data calls, you can connect the modem to specific cellular phones via a cable. This makes the modem function exactly as it would if you were placing the call over a regular phone line, and brings the same advantages to data connection that a cellular phone brings to your voice calls. For example, you may transfer information when you are mobile and not able to use a standard RJ-11 telephone jack.

Since most modem software applications will not recognize that you are sending data from a cellular connection, you will have to use AT commands when transmitting or receiving data via a cellular phone.

You can access the AT command set via the Compaq Internet site at [www.compaq.com/support/portables](http://www.compaq.com/support/portables).

### Using PIN Dialing

Personal Identification Numbers (PIN) are issued by cellular airtime providers to protect customers against unauthorized calls.

From the data or fax communications application:

1. In the space provided for the phone number, type the 7-digit phone number **XXXXXXXX**, where X equals each digit of the phone number.
2. Type 3 commas (required delay to recognize PIN number) **,,,**
3. Type your 4-digit PIN number **XXXX**, where X equals each digit of the PIN number.
4. Type an exclamation point dial modifier **!**

For example, **XXXXXXXX,,,XXXX!**

## PIN Dialing When Using a Stored Dial Suffix

Use the stored dial suffix option in the data or fax communication application to automatically add your PIN number each time you make a call.

From the data or fax application:

1. In the space provided for the dial suffix, type 3 commas (required delay to recognize PIN number) ,,,
2. Type your 4-digit PIN number **XXXX** where **X** equals each digit of the PIN number.
3. Type an exclamation point dial modifier **!**

For example, ,,,**XXXX!**

## Checking Signal Strength

**NOTE:** Use Windows HyperTerminal to enter Command Mode and check the signal strength of the cellular phone connection.

You can use the **AT\$SI** command to check the cellular phone signal.

A cellular phone displays a standard Received Standard Signal Strength Index (RSSI) of between 80-255. If the RSSI falls below 80, make sure the phone is in an upright position and near a window. Do not place the phone on a metal surface.

## Checking the Phone and Modem Connection

**NOTE:** Use Windows HyperTerminal to enter Command Mode to check the phone and modem connection.

Check the phone and modem connection by using the **AT\$** command.

After issuing the **AT\$** commands the following responses are possible:

- If the connection is good, the modem displays the number of the cellular phone.
- If the connection is poor and you have previously registered the phone with the modem, the modem displays **PHONE DOES NOT RESPOND** or **NO PHONE**.
- If you have not previously registered the phone with the modem, the modem displays **NO PHONE NO PHONE**.

## Disabling Cellular Phone Recognition

**NOTE:** Use Windows HyperTerminal to enter Command Mode to disable cellular phone recognition.

You can disable cellular phone recognition by using the **\$M0** command. This command causes the modem to skip the process of detecting a cellular phone which occurs if **\$M1**, **\$M2**, or **\$M4** is entered.



**CAUTION:** Using the wrong cable could cause permanent damage to the modem. Contact your Compaq authorized dealer, reseller, or service provider for information on purchasing a cellular cable designed for this modem.

---

To connect a supported cellular phone in North America, follow these steps:

1. With the computer turned off, connect the 25-pin connector end of the cellular phone cable into the 25-pin connector on the right side of the computer.
2. Turn on the computer.
3. Insert the opposite end of the cellular phone cable into the connector of your cellular phone. (Size and shape of connector varies depending on the cellular phone manufacturer.)
4. Turn on the cellular phone.

**NOTE:** The modem will not enter Suspend if it is registered with a data-ready cellular phone.

## Registering the Phone with the Modem

**NOTE:** Use Windows HyperTerminal to enter Command Mode and register the phone with the modem.

When the modem was installed at the factory, it was not programmed to automatically expect a cellular phone connection. If you anticipate using a cellular phone with the modem, use one of the following methods to register or set up the cellular phone with the modem:

- Use **\$M1** if you are using a Motorola, JVC, or Pioneer phone.
- Use **\$M2** if you are using a Nokia, Technophone, AT&T (selected models), or Tandy phone.
- Use **\$M4** if you are using a GE or Ericsson phone.

**NOTE:** **\$M3** is not supported by this modem.

You can access the **\$** command set via the Compaq Internet site at [www.compaq.com/support/portables](http://www.compaq.com/support/portables).

This command needs to be issued only once; thereafter, the modem checks for the presence of the phone. If a cellular phone is connected, the modem dials through the cellular phone; otherwise, it uses a standard (RJ-11) telephone connector.

# Modem Compatibility

The internal modem is compatible with the following data and facsimile communications standards:

## Command Set

- Hayes AT command set (EIA/TIA 602)

## Data Communications

- ITU V.34 Annex (33600 bps)
- ITU V.34 (28800 bps)
- ITU V.32 (19200 bps)
- ITU V.32bis (14400 bps)
- ITU V.32 (9600 bps)
- ITU V.23 (1200/75 bps)
- ITU V.22bis (2400 bps)
- ITU V.22 (1200 bps)
- ITU V.21 (300 bps)
- Bell 212A (1200 bps)
- Bell 103 (300 bps)

## Facsimile Communications

- ITU V.17 (14400 bps)
- ITU V.29 (9600 bps)
- ITU V.27ter (4800 bps)
- ITU V.21 Ch2 (300 bps)
- Class I facsimile extensions to the Hayes AT command set (EIA/TIA 578)
- Support for Group III facsimile machines

## Cellular Enhancements

- Cellular direct connect to select cellular phones that include Ericsson, GE, JVC, Motorola, Nokia, Tandy, and Technophone phones.
- MNP 5

## Data Compression

- ITU V.42bis
- MNP 5

## Error Control

- ITU V.42 (LAPM)
- MNP 2-4



# *chapter* 9

## ADDITIONAL FEATURES

Your computer comes equipped with the following additional features:

- Audio components, including microphone and speakers
- Infrared connection capability
- CardBus PC Card slots
- Intelligent Manageability software

This chapter discusses each of these features in detail.

# Identifying Audio Connections



The computer has three audio connections:

- ❶ stereo speaker/headphone jack
- ❷ microphone jack
- ❸ stereo line-in jack



**CAUTION:** Use only a 3.5-mm stereo plug in the stereo speaker/headphone jack. A mono plug can result in damage to the computer.

---

**IMPORTANT:** A mono electret condenser microphone is recommended. Plugging a stereo microphone in the mono microphone jack is acceptable, but the left channel will be recorded on both the left and right channels.

## Using Internal and External Microphones

The computer has both an integrated mono microphone located on the display and an external microphone jack located on the right side of the computer. Use either of these to record sound, enhance an interactive demonstration with high-quality stereo sound, or to take advantage of business programs and presentation software having audio capability.



The internal microphone is located above the middle right of the display ②. It is disabled when the external microphone jack ① is used.

**IMPORTANT:** A non-stereo microphone is recommended. Use a 3.5 mm mono-electret condenser microphone. Plugging a stereo microphone in the mono microphone jack is possible, but the left channel will be recorded on both the left and right channels.

## Using Internal and External Speakers

The integrated stereo speakers support sound output for WAV file and MIDI playback, and audio from the optional CD-ROM drive. They also support external audio input devices such as a CD player, tape deck, stereo tuner, or wave synthesizer connected to the computer through the stereo line-in jack. Headphones or external speakers can be connected to the computer through the stereo speaker/headphone jack. Headphones or external speakers can be connected to the computer through the stereo speaker/headphone jack.

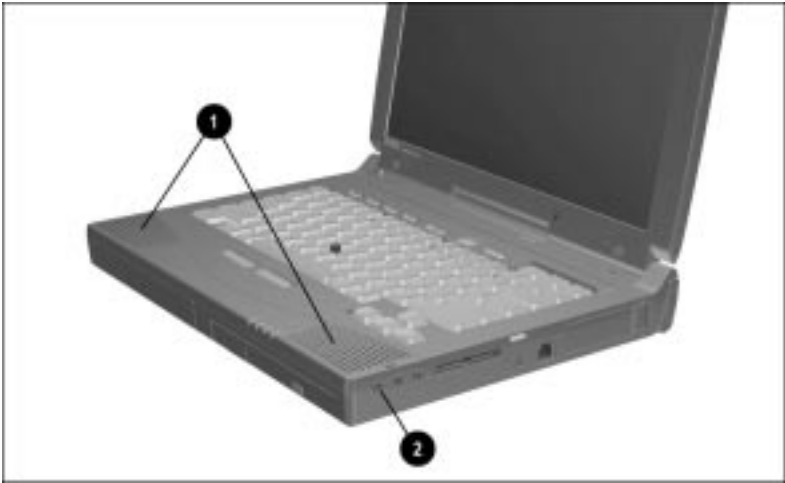

The internal stereo speakers are located on the front left and right corners of the computer ❶. When external speakers or headphones are connected to the stereo speaker/headphone jack ❷, the internal speakers are disabled.

External speakers:

- Provide more separation for the left and right audio channels.
- Produce more volume with amplified speakers.
- Produce higher quality sound.



**CAUTION:** Use only a 3.5-mm stereo plug in the stereo speaker/headphone jack. A mono plug can result in damage to the computer.

---

# Controlling Audio Volume

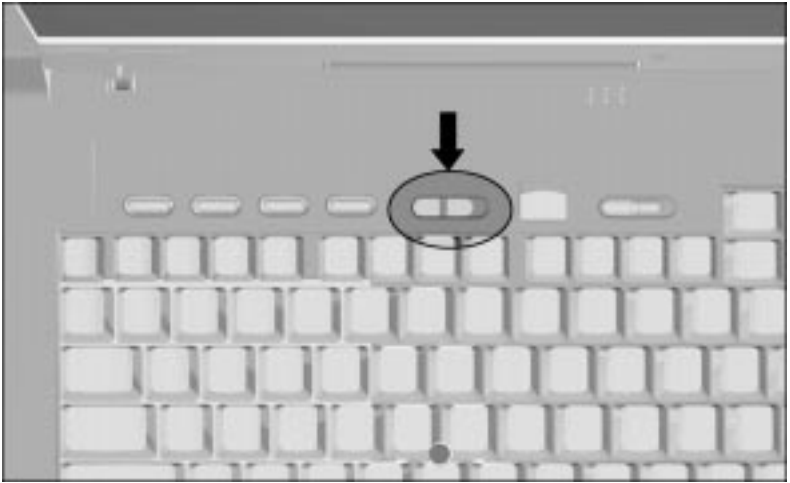

**WARNING:** To reduce the risk of personal injury to hearing, check the volume level of software applications before you put on headphones.

---

Controlling the audio volume affects stereo speakers, headphones, and the external speakers connected to the stereo speaker/headphone jack. Volume controls also affect the stereo speakers in the optional desktop expansion base.

Control the audio volume using any of the following methods:

- The volume down and up buttons at the top center of the keyboard. To mute the sound, press both volume buttons at the same time.
- The **Fn+F5** hotkeys to adjust the volume of system warning beeps.
- The volume control features available from the Audio tab in Multimedia Properties.

Some software applications, such as game programs, include their own volume controls. You may need to adjust the software volume controls to get the desired sound levels.

The volume control on the computer overrides all other software volume controls. That is, the volume from the integrated stereo speakers, external speakers, or headphones will never be louder than the sound level selected using the computer volume control.

## Infrared Connections



**NOTE:** Infrared-equipped computers are IrDA-compliant (4Mbps standard). Infrared performance may vary depending on performance of infrared peripherals, distance between infrared devices, and applications used.

The infrared port on your computer allows wireless communication between your computer or desktop expansion base and other infrared-equipped devices. Operating system support for infrared communication is currently available with Microsoft Windows 95.

The infrared port uses an invisible beam of infrared light to communicate with another infrared-equipped device.

If you are running Windows 95 to establish an infrared link:

- Be sure the infrared ports on both computers are turned on and facing each other at a distance no greater than 1.5 feet (about 0.5 meter).
- Avoid moving the infrared ports away from each other during data transmission.
- Avoid interference from remote control units, such as wireless headphones or audio devices, pointed at the infrared ports.
- Avoid direct sunlight, fluorescent light, or flashing incandescent light close to the infrared ports.
- Keep the path between the infrared ports free of any objects that might interfere with data transmission.

**NOTE:** Do not point one of the ports more than 30 degrees (plus or minus 15 degrees off the center line) away from the infrared port of the device you are connecting with.

## Types of PC Cards

There are three PC Card types set by the PCMCIA standards association: Type 1 (3.3 mm), Type 2 (5.0 mm), and Type 3 (10.5 mm).

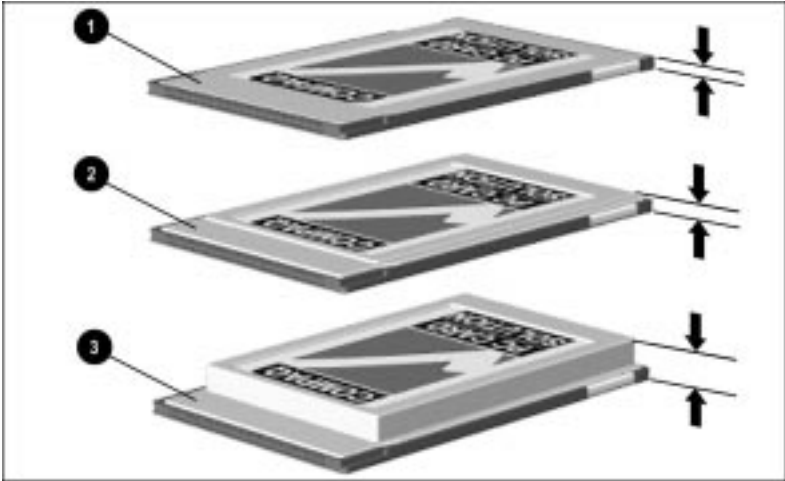

Type II and Type III PC Cards also come in extended PC Cards. The computer supports up to two PC Cards simultaneously: either one Type III card with one Type I or Type II card, or two Type I and Type II cards, in any combination. The computer supports several kinds of PC Cards, such as network cards, hard drive cards, memory cards, and fax/modem cards.



## Inserting a PC Card



**CAUTION:** To prevent damage to the connectors, use minimal pressure when inserting a PC Card into a PC Card slot.

---



To insert a PC Card into the computer:

1. Open the PC Card door.
2. Hold the PC Card with the label side up.
3. Insert the 68-pin side of the PC Card into the slot, pushing gently.

If you are running Windows 95, you do not need to turn off the computer or initiate Suspend before inserting a PC Card.

**NOTE:** If the computer is turned off or in Suspend, the card is not configured until you turn on the computer or exit Suspend.

If you are running Windows NT 4.0 without CardWare provided by Compaq, turn off the computer.

If you are running Windows NT with CardWare provided by Compaq, you should be able to insert most PC Cards while the computer is turned on. Contact your PC Card vendor directly for information about the level of support they offer for "hot insertion" with CardWare.

**IMPORTANT:** Before a new PC Card can be used, it may be necessary to perform an initial setup procedure. Be sure to follow the PC Card manufacturer's instructions for installing the needed card-specific device drivers.

# Removing a PC Card

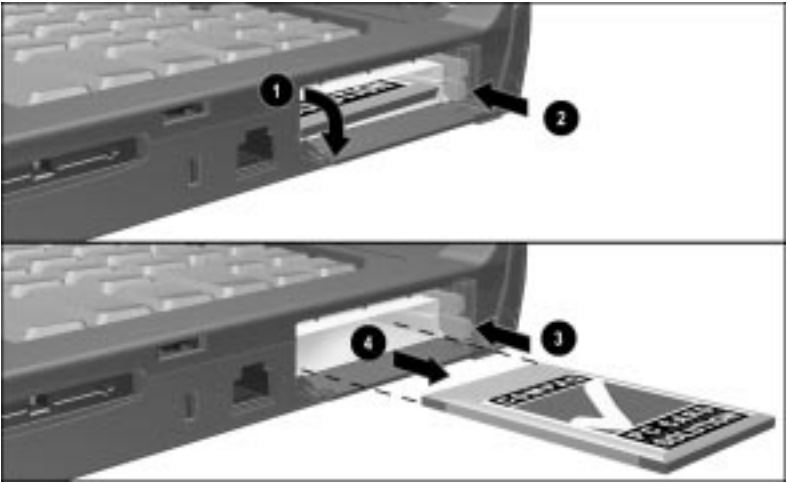

If you are running Windows 95, you do not need to turn off the computer or initiate Suspend before removing a PC Card.



**CAUTION:** If you are running Windows 95, you should always stop PC Cards before removing them to prevent damage to the PC Card or computer.

If you are running Windows NT without CardWare provided by Compaq, you must turn off the computer before removing a PC Card.

To remove a PC Card from the computer:

1. Open the PC Card door to access the PC Card slots and eject buttons ❶.
2. Depress the appropriate PC Card release button; the button should now be fully extended ❷.
3. Depress the fully extended button to eject the PC Card from the slot ❸.
4. Remove the PC Card ❹.

**NOTE:** If you are running Windows 95, the computer beeps twice if it is turned on when the PC Card is removed.

## Enabling/Disabling PC Card Slots

PC Cards are power options in a small form factor. When PC Cards are installed in your computer, they draw power from the system even when they are not in use.

If you are running Windows 95, remove PC Cards when they are not in use to conserve power, or you may turn off power to the PC Card slots through Power Properties.

If you are running Windows NT, remove PC Cards when they are not in use to conserve power.

If you are operating the computer on a battery pack, disabling power to the PC Card slots extends battery life. You can also turn off power to the PC Card slot by placing the computer in Suspend.

## PC Card Device Drivers

Device drivers are programs or data files containing information needed to run a particular PC Card. Most of the device drivers you need are preinstalled on the computer.

**NOTE:** In order to save available memory, some device drivers are not turned on.

Some types of PC Cards, such as network cards, Global Positioning System (GPS) cards, SCSI cards, audio cards, and multifunction cards, require an additional software device driver specific to the PC Card to function properly. This device driver is provided on diskette by the PC Card manufacturer and should be installed according to the manufacturer's instructions. Do not install any other PC Card software on the computer such as Card and Socket Services, even if prompted to do so.



**CAUTION:** Compaq has rigorously tested the PC Card software preinstalled on the computer. If you install Card and Socket Services or enablers provided by other vendors over software preinstalled on the computer, your computer may no longer work properly with all of your PC Cards.

---

## Zoomed Video

The bottom PC Card slot is designed for a Zoomed Video PC Card. Use of Zoomed Video cards is not supported under Windows NT at this time. A Zoomed Video PC Card enables higher overall system performance for full motion video playback.

## Intelligent Manageability

Intelligent Manageability consists of preinstalled software tools for the computer and Compaq servers that assist in tracking, troubleshooting, protecting, and maintaining the computer. It provides the following functions:

- **Asset Management**—provides detailed configuration and diagnostic information.
- **Fault Management**—prevents, predicts, and alerts of impending hardware problems.
- **Security Management**—protects unauthorized access to data and components.
- **Configuration Management**—optimizes the computer by providing the latest drivers, utilities, and software, which are available on CD-ROM and the Compaq Web site at [www.compaq.com/support/portables](http://www.compaq.com/support/portables).

**NOTE:** For further help with Intelligent Manageability, refer to Intelligent Manageability Help.

## Asset Management

AssetControl enables the user to retrieve component information when on the road or connected to the network.

AssetControl also enables the network administrator to remotely retrieve information from any Compaq computer connected to the network. The information can be used to assist in tracking and maintaining the computer and its components. It provides the following information:

- **Inventory information**—The network administrator can retrieve information about the computer over the network by using Compaq Insight Manager or any PC management tool provided by Compaq Solution Partners. Asset control information retrieved from the computer includes
  - Manufacturer, model, and serial number of Compaq computers, monitors, hard drives, battery packs, memory boards, processor speeds, and operating systems
  - Asset tag
  - System board and ROM revision levels
  - BIOS settings
  - And more
- **Diagnostic information**—Diagnostics for Windows includes information on hard drives, ports, and video, sound, and other components. This application also allows the user to run multithreaded tests on hardware components. If problems are found, recommendations are provided.

All of the above information can be viewed, printed, or saved.

### Changing the Asset Tag Number

1. Turn on or restart the computer.
2. Press **F10** when the cursor appears in the upper-right corner of the screen.
3. Select Computer Setup → Intelligent Manageability.
4. Follow the instructions on the screen.

## Fault Management

Fault Management features minimize downtime and data loss by monitoring system performance and generating the following alerts:

- **Hard drive alert**—warns you up to 72 hours in advance of impending hard drive problems and can automatically start optional backup software.
- **System temperature alert**—reports overheating. As the system temperature rises, this feature first adjusts fan speed and other cooling components, then displays an alert, then shuts down the system.
- **Battery pack alert**—reports charging problems and battery pack failure.
- **Monitor alert**—diagnoses and displays external monitor operational problems.
- **Memory alert**—reports memory board configuration changes when a memory board is removed, added, or reconfigured. It also provides the previous and current configurations for comparison.

The alerts work with or without network connection. Of course, if your computer is not connected to the network, your network administrator cannot receive alerts from your computer.

### Fault Management Alerts

Alerts can be enabled, disabled, and tested, and software can be set to back up information whenever a hard drive alert occurs.

- While the computer is connected to a network, alerts pop up on the computer display and are simultaneously reported to the network console.

**NOTE:** A battery charging problem alert is reported only on the computer display.

- When the computer is not connected to a network, the user will receive a local alert.

To set alerts, double-click the Intelligent Manageability icon in the system tray.

## Security Management

Security Management features customize system security.

- **Power-On and Setup Passwords**—prevent unauthorized access to your information and computer configuration.
- **DriveLock**—prevents unauthorized access to hard drives.
- **Device disabling**—prevents unauthorized data transfer through modems, serial ports, parallel ports, and infrared ports on the computer and an optional docking station.
- **QuickLock/QuickBlank**—locks the keyboard and clears the screen.
- **Ownership Tag**—displays ownership information during system restart.

## Configuration Management

The Configuration Management optimizes software upgrade and customer support procedures. Compaq provides you with support software to optimize the performance of your computer. This support software is accessible through a monthly CD-ROM subscription. Support software can also be downloaded from the Compaq Internet site at [www.compaq.com/support/portables](http://www.compaq.com/support/portables). To quickly find support software for your computer, use:

- **Locator browser**—searches for the latest device drivers, utilities, ROM images, and other support software on a CD-ROM and at the Compaq Internet site at [www.compaq.com](http://www.compaq.com).
- **Decision Support**—provides detailed information about new drivers, utilities, and software. The information includes descriptions, features, enhancements, dependencies, and necessary upgrades.
- **Info Messenger**—provides notifications by email when support software for your computer becomes available.



# *chapter* 10

## COMPUTER SETUP AND DIAGNOSTICS

The chapter introduces the Compaq setup and diagnostic utilities. These utilities contain several diagnostic functions that

- Determine if various computer devices are recognized by the system and are operating properly.
- Provide information about the system once it is configured.

Compaq utilities include the following diagnostic programs:

- Computer Setup
- Computer Checkup (TEST)
- View System Information (INSPECT)
- Compaq Diagnostics

### Using Computer Setup

Computer Setup contains a group of utilities that give you an overall picture of the computer's hardware configuration and aid in troubleshooting. These utilities also allow you to set custom features, such as security options, power conservation levels, and startup preferences.

If you are running Windows 95, your computer automatically recognizes and configures the system for new devices. However, if you have a configuration problem, or want to view or reset configuration settings, you can use Computer Setup.

**NOTE:** If you are running Windows 95, you should use Computer Setup only to adjust system features such as the power-on password or battery conservation level. Windows 95 may override other configuration changes.

If you are running Windows NT, your computer does not automatically recognize new devices added to your system. All devices ordered with your system have been configured for you. Use Computer Setup to view settings for a new device you have added or to reset configuration settings for preinstalled devices.

Computer Setup provides two methods of viewing the computer's configuration: by type or connection. The default method for viewing Computer Setup is by type.

Categories by Type include:

- **System Features**—security, power, boot management
- **Communication**—port, modem, other communication devices
- **Storage**—storage-related devices such as hard drive or diskette
- **Input Devices**—keyboard, mouse, and other input devices
- **Network**—network adapter, or other network-related devices
- **Audio**—sound properties and audio device settings
- **Video**—monitor timeouts and video device resources
- **Other**—miscellaneous devices

Categories by Connection include:

- **System Features**— security, power, boot management
- **System Devices**—keyboard, mouse, parallel and serial ports
- **ISA**—ISA bus and related devices
- **PCI**—PCI bus and connected devices
- **PC Card (PCMCIA)**—PC Card devices

The boot sequencing feature allows you to select your preferred startup options. To create your own sequence, follow these steps:

1. Run Computer Setup.
2. Click the System Features icon.
3. Click the Boot Management box.
4. Click the MultiBoot tab to view boot (startup) options.
5. Designate the hard drive boot (startup) sequence you want.
6. Click OK to accept the changes.

# Running Computer Setup

Computer Setup contains a group of utilities that give you an overall picture of the computer's hardware configuration and aid in troubleshooting. These utilities also allow you to set custom features, such as security options, power conservation levels, and startup preferences.

1. Turn on or restart the computer by clicking Start → Shut Down → Restart the computer.
2. Press **F10** when the blinking cursor appears near the upper-right corner of the display.
3. Select Computer Setup and press Enter.
4. Select Exit when you are finished running Computer Setup. A series of Exit options appear.

**NOTE:** The first time you use the computer, select the language you need when the Welcome screen appears, and press Enter.

If you enabled a setup password, it must be used to access Computer Setup.

# Exiting Computer Setup

1. Click Exit.
2. Select one of the following Exit options:

- Save  
Saves the new settings and exits Computer Setup.  
**NOTE:** Some settings may not take effect until you restart the computer.
- Ignore  
Exits and restores previous Computer Setup settings.
- Cancel  
Returns to Computer Setup.

# Running Computer Checkup (TEST)

Computer Checkup (TEST) determines whether the various computer components and devices are recognized by the computer and are functioning properly. You can display, print, or save the information generated by Computer Checkup.

To run Computer Checkup:

1. Plug the computer into an external power source.  
(A low battery condition could interrupt the program.)
2. Connect a printer if you want to print a log of error messages.
3. Turn on the external devices that you want to test.
4. Turn on or restart the computer.
5. Access Compaq Utilities by pressing **F10** when the blinking cursor appears in the upper-right corner of the display.
6. Select Computer Checkup from the Compaq Utilities menu.
7. Select View the Device List from the Test Option menu.
  - If the list of installed devices is correct, select OK.
  - If the list is incorrect, ensure that any new devices are installed properly.

**NOTE:** Compaq Diagnostics Utilities are intended for testing only Compaq-supplied components. Testing of non-Compaq components may be inconclusive. If there is a problem with a non-Compaq component, contact your authorized dealer, reseller, or service provider.

8. Select one of the following from the Test Option menu:
  - Quick Check Diagnostics
  - Automatic Diagnostics
  - Prompted Diagnostics
9. Follow the instructions on the screen as the devices are tested. When testing is complete, the Test Option menu appears.
10. Select Exit Diagnostics from the Test Option menu.
11. Select Exit from this utility from the Compaq Utilities menu.

# Running View System Information (INSPECT)

The View System Information (INSPECT) utility provides information about the computer and installed or connected devices. You can display, print, or save the information.

To run INSPECT:

1. Plug the computer into an external power source. (A low battery condition could interrupt the program.)
2. Connect a printer if you want to print the INSPECT information.
3. Turn on or restart the computer by pressing the power switch.
4. Access Compaq Utilities by pressing **F10** when the blinking cursor appears in the upper-right corner of the display.
5. If prompted, select the desired language. The Compaq Utilities menu is displayed.
6. Select View System Information (INSPECT) from the Compaq Utilities menu.
7. Select the item you want to view from the following list:

System	Memory
ROM	Audio
Keyboard	Operating system
System ports	System files
System storage	Windows files
Graphics	

8. Follow the instructions on the screen to cycle through the screens, to return to the list and choose another item, or to print the information.

# Factory Default Settings

Your computer is shipped with the following default settings:

<b>Initialization</b>	
Enable POST Memory Test	Checked
Keyboard Num Lock	Unchecked
<b>Hard Drive Boot Sequence</b>	
1	Notebook MultiBay
2	Notebook Hard Drive Bay
3	Base Half-Height/MultiBay
4	Base MultiBay
Boot Display	Auto
Language	Language of country
<b>Ports</b>	
Serial/Infrared Ports	
Serial Port	3F8, IRQ4
Infrared Port	2F8, IRQ9
Parallel Port	378, IRQ7
Ethernet Port	300, IRQ11
Modem (availability varies by model and geographic region)	3E8, IRQ4
<b>Power</b>	
Low Battery Warning Beep	Checked
External Energy Saving Monitor Connected	Unchecked

*Continued*

## Factory Default Settings *Continued*

### Power Management

Enabled	While on Battery
Conservation Level	High
Level Definition	
High	Suspend Time: 3 minutes
	Hibernation Timeout: Immediate
	Drive Timeout: 1 minute
	Screen Timeout: 1 minute
Medium	Suspend Time: 5 minutes
	Hibernation Timeout: 1 hour
	Drive Timeout: 2 minutes
	Screen Timeout: 3 minutes
Custom	Suspend Time: disabled
	Hibernation Timeout: low battery
	Drive Timeout: always on
	Screen Timeout: always on

### Security

Enable QuickLock/QuickBlank	Unchecked
Enable Power-On Password	Unchecked
Disable Serial/Infrared Ports	Unchecked
Disable Parallel Port	Unchecked
Disable PC Card Slots	Unchecked

Setup Password Password blank

Power-On Password Password blank

DriveLock Unprotected

### Diskette Drives

Disable Diskette Drives	Unchecked
Disable Diskette Boot	Unchecked

# Running Compaq Diagnostics

Compaq Diagnostics is a utility that inspects computer hardware, internal system temperature, and the SMART hard drive, then displays a prefailure warning message upon detecting a system temperature or hard drive fault.

If you are running Windows 95, access Compaq Diagnostics for Windows by double-clicking My Computer → Control Panel → Compaq Diagnostics.

If you are running Windows NT, access Windows NT Diagnostics by clicking Start → Programs → Administrative tools → Windows NT Diagnostics.



# *chapter* 11

## CARE, TRAVEL, AND SHIPPING GUIDELINES

You may often want to travel with your computer, even if just from room to room. When traveling, you may have to ship the computer to your destination. This chapter provides helpful information regarding care, travel, and shipping.

### Caring for the Computer

Keep the computer in good condition and working properly by following these guidelines:

- Keep the computer away from excessive moisture and temperature extremes. Do not expose the computer to liquids or precipitation.
- Remove the battery pack from the computer if the computer will not be used for more than two weeks. Store the battery pack in a cool, dry place.
- To prevent possible damage to the display, do not place anything on top of the computer when it is closed.
- Occasionally wipe the exterior of the computer and the screen with a soft, damp cloth moistened only with water. Using soap or other cleaning products may discolor the finish and damage the screen.



**WARNING:** *Do not spray liquid directly on the computer screen. Excess liquid may drip down inside the computer and damage the components or result in electrical shock.*

---

## Operating Temperatures

The computer is designed to run demanding applications that require PC Cards, CD-ROM drives, and large amounts of RAM while maintaining full processor performance.

As a result of increased power consumption, it is normal for the computer to feel warm to hot when being used for extended periods.

The computer complies with international safety standards for temperatures of user-accessible surfaces.

## Traveling with the Computer

For safety and convenience when traveling, follow these guidelines:

1. Back up your data. Do not expose your backups to electrical or magnetic impulses while stored or in transit.
2. If there is a diskette or compact disc in a drive, remove it.
3. Turn off the computer and external devices.
4. Close the computer.
5. Disconnect external equipment from the computer.
6. Close the connector cover and all exterior doors.
7. Hand-carry the computer in a briefcase or other protective case. Do not check the computer with your luggage.

Check with the airline if you plan to use the computer on the plane. In-flight computer use is at the discretion of the airline.

**IMPORTANT:** There are three types of airport security devices: X-ray machines (the conveyor belt device you set your bags on), magnetic detectors (the device you walk through), and security magnetic wands (the hand-held device used by security personnel). You can send your computer and diskettes through airport X-ray machines. However, Compaq recommends that you do not send your computer and diskettes through airport magnetic detectors or expose them to security magnetic wands.

Before traveling internationally with the computer:

- Check local customs regulations for restrictions and requirements on traveling with your computer.
- Purchase (from a Compaq authorized dealer, reseller, or service provider) a power cord for the country where you will be using the computer. These power cords are designed to meet the voltage and frequency requirements of each country.



**CAUTION:** *Do not use the converter kits sold for appliances to power the computer.*

---

## Shipping the Computer

Follow these steps when shipping the computer:

1. Back up your data. Do not expose your backups to electrical or magnetic impulses while stored or in transit.
2. If there is a diskette or compact disc in a drive, remove it.
3. Turn off the computer and external devices.
4. Close the computer.
5. Disconnect external equipment from the computer.
6. Close the connector cover and all exterior doors.
7. Pack the computer and external devices in their original packing boxes, or in similar packaging with sufficient packing material to protect them and prevent shifting or movement in transit.



# *chapter* 12

## TROUBLESHOOTING

### Checklist for Solving Problems

If you encounter some minor problem with the computer or software applications, go through the following checklist for possible solutions:

- Is the computer connected to an external power source or does it have a fully charged battery installed?
- Are all cables connected properly and securely?
- Did the diskette drive contain a non-bootable diskette when you turned on the computer?
- Have you installed all the needed device drivers? For example, if you are using a mouse, you may need to install a mouse device driver.
- Have you installed the appropriate printer drivers?

While the computer is configured just for you, problems you encounter while working may not be unique. Eliminating the typical problems described in this section may save you time and money. If you have a problem with the computer, consider the problems and possible solutions outlined in troubleshooting. If the problem appears related to a software application, also check the documentation provided with the software. You may discover something you can resolve easily by yourself. If the condition persists, contact your Compaq authorized dealer, reseller, or service provider.

## Solving Audio Problems

Problem	Possible Cause	Solution
Computer does not beep after the Power-On Self-Test (POST).	System beeps have been turned down.	Use the <b>Fn+F5</b> hotkeys to turn up the system volume.
Internal speaker does not produce sound when an external audio source is connected to the stereo line-jack.	Volume may be turned off or set too low.	<ul style="list-style-type: none"> <li>■ Adjust the volume control at the top middle of the computer above the keyboard.</li> <li>■ Use the volume control and mixing features available in Control Panel → Multimedia.</li> <li>■ Adjust the volume using the speaker icon on the taskbar.</li> </ul>
	Line input may not be connected properly.	Check line input connection.
	Headphones or speakers are connected to the stereo speaker/headphone jack, which disables the internal speakers.	Disconnect the headphones or speakers to enable the internal speakers.
External microphone does not work.	You are using the wrong type of microphone or microphone plug for the computer.	Check to see if you are using a monophonic electret condenser microphone with a 3.5-mm plug.
	The microphone may not be connected properly.	Ensure that the microphone plug is properly connected to the mono microphone jack.
	Sound source not selected.	Ensure that microphone is selected as the recording source in Control Panel → Multimedia and that the recording level is adjusted.
	Audio settings are not set correctly.	Check the game program's audio settings.
	Volume control on the computer is turned down.	Adjust the volume control at the top middle of computer above the keyboard.
	Headphones are connected.	Use or disconnect the headphones.

*Continued*

## Solving Audio Problems *Continued*

<b>Problem</b>	<b>Possible Cause</b>	<b>Solution</b>
No sound from headphones	Volume or mixing controls set incorrectly.	<ul style="list-style-type: none"><li>■ Adjust the volume control at the top middle of computer above the keyboard.</li><li>■ Use the volume control and mixing features available in Control Panel → Multimedia.</li></ul>
	Sound source not selected.	Verify that the sound source is selected in Control Panel → Multimedia.
	The headphones are connected to the wrong jack.	Check the connection.
Volume too low or too loud	Volume or mixing controls set incorrectly.	<ul style="list-style-type: none"><li>■ Adjust the volume control located at the top middle of computer above the keyboard.</li><li>■ Check the volume and mixer controls in Control Panel → Multimedia.</li></ul>

## Solving Battery/Battery Gauge Problems

Problem	Possible Cause	Solution
Computer is beeping and battery power light is blinking.	Battery pack charge is low.	<ul style="list-style-type: none"> <li>■ Charge the battery pack by connecting to an external power source.</li> <li>■ Replace the battery pack with another fully charged battery.</li> <li>■ Initiate Hibernation or turn the computer off until AC power or a fully charged battery is available.</li> </ul>
Computer battery power light blinks to indicate low battery condition, but computer does not beep.	Volume turned down too low.	Turn up the volume using the volume control on the top center of the computer.
Battery pack will not charge.	The battery pack may still be in ship mode if this is the first time the computer is used.	Take the battery pack out of the battery bay and reinsert it to enable the charging mechanism.
	Battery pack was exposed to temperature extremes.	Allow time for the battery pack to return to room temperature.
	Battery pack is already charged.	No action required.
	Battery pack has exceeded its useful life cycle.	Use a different battery pack.
	Battery pack may be inaccurate and require recalibration.	Fully discharge and recharge the battery to recalibrate the gauge.
Computer shut down and memory was lost when replacing the battery pack.	When the computer is in Suspend, the battery pack must be replaced within 10 minutes to prevent loss of information.	Wait a few seconds until the computer initiates Suspend before removing the battery pack. Insert the battery pack within 10 minutes.

*Continued*



## Solving Battery/Battery Gauge Problems *Continued*

<b>Problem</b>	<b>Possible Cause</b>	<b>Solution</b>
Battery charge does not last very long.	Battery is exposed to higher temperatures.	Put the computer in a cooler place and recharge the battery pack.
	Battery is exposed to extremely cold temperatures.	Put the computer in a warmer place and recharge the battery pack. <b>NOTE:</b> The recommended operating temperature range for the battery is from 10°C to 40°C (50°F to 104°F). The recommended storage temperature range for the battery is from -20°C to 30°C (-4°F to 86°F).
	Battery has partially self-discharged.	Recharge the battery.
	Battery conservation is disabled or set to drain.	Reset the battery conservation level.
	An external device is draining the battery.	Turn off or remove any external device or PC Cards when not in use.
	Battery gauge may be inaccurate and require recalibration.	Fully discharge and recharge the battery to recalibrate the gauge.

---

## Solving Compact Disc/CD-ROM Drive Problems

---

<b>Problem</b>	<b>Possible Cause</b>	<b>Solution</b>
CD-ROM drive cannot read a compact disc.	Compact disc is not properly seated in the CD-ROM drive.	Open the CD loading tray, lay the compact disc in it, then close it.
	Compact disk is loaded in the CD loading tray upside down.	Open the CD loading tray, turn over the compact disc (label facing up), then close the CD loading tray.
	Compact disc has a scratch on its surface.	Insert a different compact disc.
CD-ROM drive is not detected by the computer.	CD-ROM drive is not connected properly.	If you are running Windows NT, turn off the computer or put it into Suspend. Remove the CD-ROM from the MultiBay and reinsert it.
		If you are running Windows 95, turn off the computer. Remove the CD-ROM drive from the MultiBay and reinsert it.

---

---

## Solving Diskette Drive Problems

---

Problem	Possible Cause	Solution
Diskette drive cannot write to a diskette.	Diskette is not formatted.	Format the diskette: If you are using Windows 95: <ol style="list-style-type: none"><li>1. From the Windows desktop, double-click My Computer.</li><li>2. Click on 3.5-in. Floppy (A).</li><li>3. Click File, then Format.</li><li>4. Fill in the appropriate information, then click Start.</li></ol> If you are using Windows NT, format the diskette by entering <b>format a:</b> at the system prompt.
	Diskette is write-protected.	Use another diskette that is not write-protected or disable the write-protect feature.
	Writing to the wrong drive.	Check the drive letter in your path statement.
	Not enough space is left on the diskette.	Save the information to another diskette.
	Diskette drive is disabled.	Enable the diskette drive through Device Manager.
	Disable diskette write ability is turned on.	Run Computer Setup. Click the Storage icon. Make sure Disable diskette write ability is not checked.

---

---

## Solving Hard Drive Problems

---

<b>Problem</b>	<b>Possible Cause</b>	<b>Solution</b>
Accessing information on the hard drive is much slower than usual.	System entered Hibernation due to low-battery condition and is now exiting from it.	Wait for the system to restore the previously saved data to its state prior to initiating Hibernation.
Hard drive does not work.	Hard drive is not seated properly.	Turn off and unplug the computer, remove the hard drive, and reinsert the hard drive.
Errors occur after starting from an additional hard drive.	Additional hard drive has not been specially prepared with necessary software.	Boot from the original hard drive or a specially prepared hard drive.

---

---

## Solving Infrared Problems

---

<b>Problem</b>	<b>Possible Cause</b>	<b>Solution</b>
Cannot communicate with another computer	The appropriate software is not running on both computers.	Install the appropriate software on the second device, start the second device, and start the program on both computers.
	The other computer does not have an IrDA-compliant infrared port. Your Compaq computer uses the IrDA communications protocol.	Communication between infrared devices must use the same communications protocol. Check the manufacturer's instructions for connecting with infrared devices or try connecting with a device you know to be IrDA-compliant.
	The pathway between the infrared ports is obstructed, one port is more than 30 degrees (plus or minus 15 degrees off the center line) from the other, or the ports are more than one meter apart.	Remove the obstruction, align the infrared ports to within 30 degrees, and position computers within 1.5 feet (about 0.5 meter) of each other.
	There is an interrupt request (IRQ) conflict.	Check for IRQ conflicts in the Device Manager. If two devices have the same IRQ address, reassign one of the devices.
	There is a baud rate conflict.	Select the same baud rate for both computers.
	There is a conflict with the # bits.	Select the same # bits setting for both computers.
	There is a stop byte conflict.	Select the same stop byte for both computers.
	There is a parity conflict.	Select the same parity setting for both computers.

*Continued*

## Solving Infrared Problems *Continued*

<b>Problem</b>	<b>Possible Cause</b>	<b>Solution</b>
Cannot transmit data	Direct sunlight, fluorescent light, or flashing incandescent light is close to the infrared connections.	Remove the interfering light source(s).
	There is interference from other wireless devices.	Keep remote control units such as wireless headphones and other audio devices away from the infrared connections.
	There is a physical obstruction in the way.	Do not place objects that will interfere with a line-of-sight data transmission between the two units.
	One of the units was moved during data transmission.	Do not move either unit during data transmission.
	The orientation of the units is wrong.	Adjust the devices so that they point directly at each other.
	The distance between the units is too great.	Verify that devices are not more than 1.5 feet (0.5 meter) apart.
Infrared port doesn't work.	Direct sunlight, fluorescent light, or flashing incandescent light is close to the infrared connections.	Remove the interfering light source(s).
	There is interference from other wireless devices.	Keep remote control units such as wireless headphones and other audio devices away from the infrared connections.

---

## Solving Keyboard/Numeric Keypad Problems

---

<b>Problem</b>	<b>Possible Cause</b>	<b>Solution</b>
Screen is blank and keyboard is working.	A screen timeout has been initiated..	Press any key to refresh the screen.
	QuickLock/QuickBlank has been initiated	To renewable the keyboard and return your information to the screen, enter your power-on password.
Embedded numeric keypad on computer keyboard is disabled.	Num Lock function is not turned on	Press <b>Fn+Num Lk</b> to enable the Num Lock function and embedded numeric keypad.

---

## Solving Modem Problems

---

<b>Problem</b>	<b>Possible Causes</b>	<b>Solution</b>
Modem loses connection.	The cable connection from the phone line to the modem is loose.	Check to make sure the telephone cable is properly connected.
	Call Waiting has not been disabled.	Disable Call Waiting: 1. Click Start → Setting → Control Panel → double-click Modems. 2. From the General tab of the Modems Properties page, click Dialing Properties. 3. From the My Locations tab of the Dialing Properties page, check the box labeled This location has call waiting. Then select *70, 70#, or 1170 from the drop-down list to disable call waiting for your dialing area.

---

*Continued*

## Solving Modem Problems *Continued*

<b>Problem</b>	<b>Possible Cause</b>	<b>Solution</b>
Characters are garbled/transfer rates are slow.	There is noise in the telephone line.	<ul style="list-style-type: none"><li>■ Check your telephone and modem cable connections. If they are a little loose, they can cause noise on the line.</li><li>■ Check with your local telephone company for a phone line filter.</li></ul>
Phone line noise causing a disconnection.	Hang-up Delay S Register (S10) set too low.	<p>Change S10 default to 150.</p> <p>To set S10=150:</p> <ol style="list-style-type: none"><li>1. Click Start → Programs → Accessories → HyperTerminal, then go to Command Mode.</li><li>2. Type <b>ATS10=150</b> and press <b>Enter</b>.</li></ol> <p>This command causes the modem to take longer to disconnect even if there is noise on the line.</p>

*Continued*



## Solving Modem Problems *Continued*

Problem	Possible Cause	Solution
No dial tone	Phone service is not connected to the telephone wall jack.	Verify that service from the local phone company by following these steps: <ol style="list-style-type: none"><li>1. Unplug the telephone cable from the telephone wall jack.</li><li>2. Connect a telephone to the jack, pick up the handset, and listen for a dial tone. If there is a dial tone, reconnect the modem to the telephone wall jack with the telephone cable and make sure all connections are secure.</li><li>3. If there is still no dial tone, contact your local phone company or building manager.</li></ol>
	The modem is not responding to commands from the computer keyboard.	Verify the modem and computer are connected: <ol style="list-style-type: none"><li>1. Click Start → Programs → Accessories → HyperTerminal, then go to Terminal Mode.</li><li>2. Type <b>AT</b> and press the <b>Enter</b> key. If the modem displays OK, the modem and computer are working together. If the modem displays ERROR, or does not respond, restart the computer and repeat step 1.</li><li>3. Type <b>ATDT</b> and listen for a dial tone.</li><li>4. Type <b>ATH0</b> to hang up.</li></ol>
	Speaker Control AT Command (ATM) is set to 0.	To set the Speaker Control to 1: <ol style="list-style-type: none"><li>1. Click Start → Programs → Accessories → HyperTerminal, then go to Command Mode.</li><li>2. Type <b>ATM1</b> and press <b>Enter</b>.</li><li>3. Type <b>ATH1</b> and listen for the sound of the dial tone.</li><li>4. Type <b>ATH0</b> to hang up.</li></ol>

---

## Solving PC Card Problems

---

<b>Problem</b>	<b>Possible Causes</b>	<b>Solution</b>
Computer does not beep when a PC Card is inserted.	PC Card is not inserted properly.	Try reinserting the card. Ensure that the PC Card is inserted in the correct orientation. Insert the card gently to prevent damage to the pins.
	Speakers are turned off or volume is turned down.	Adjust the volume control on the computer.
	PC Card slots are disabled.	<ol style="list-style-type: none"><li>1. Run Computer Setup.</li><li>2. Click the System Features icon.</li><li>3. Click the Power Management box.</li><li>4. Click the option to enable PC Card slots.</li></ol>
	PC Card or card driver is not PCMCIA compliant.	Contact your Compaq authorized dealer, reseller, or service provider for a list of PC Cards tested successfully in Compaq PC Card platforms.
Computer beeps only once when a PC Card is inserted.	The computer beeps once to indicate that a PC Card is recognized but not properly configured.	Before a new PC Card can be used, it may be necessary to perform an initial setup procedure. Follow the PC Card manufacturer's instructions for formatting a hard drive card or installing PC Card-specific drivers for a network card.

*Continued*

## Solving PC Card Problems *Continued*

<b>Problem</b>	<b>Possible Cause</b>	<b>Solution</b>
PC Card drivers fail with error messages during system restart.	PC Card slots are disabled.	Before a new PC Card can be used, it may be necessary to perform an initial setup procedure. Follow the PC Card manufacturer's instructions for formatting a hard drive card or installing PC Card-specific drivers for a network card.  To enable the PC Card slots: <ol style="list-style-type: none"><li>1. Run Computer Setup.</li><li>2. Click the System Features icon.</li><li>3. Click the Power Management box.</li><li>4. Click the option to enable PC Card slots.</li></ol>
Network PC Card does not work.	Necessary drivers are not installed (turned on).	Refer to the instructions that came with the PC Card or contact the vendor for information on installing the correct drivers.
	PC Card is not fully inserted or is upside down.	Ensure the PC Card is inserted correctly.
	Network PC Card or driver is not PCMCIA compliant.	Contact your Compaq authorized dealer, reseller, or service provider for a list of PC Cards tested successfully in Compaq PC Card platforms.

*Continued*

## Solving PC Card Problems *Continued*

<b>Problem</b>	<b>Possible Cause</b>	<b>Solution</b>
Storage PC Card does not work.	SRAM and flash memory PC Cards require the memory card driver to be loaded.	Memory cards can only be accessed using DOS real mode drivers.
	You are trying to access the storage PC Card using the wrong drive letter.	If you are running Windows 95, change the drive letter assignment in Device Manager.  If you are running Windows NT, change the drive letter assignment through the Control Panel.
	The PC Card is not formatted.	For memory cards, run MCFORMAT in MS-DOS Mode to format the PC Card. For ATA cards, run ATAINIT, then run MCFORMAT in MS-DOS Mode to format the PC Card.
	The card is not supported.	Contact your Compaq authorized dealer, reseller, or service provider for a list of PC Cards tested successfully in Compaq PC Card platforms.
	Storage cards, such as SRAM, do not work in the ArmadaStation.	Use the storage card in the computer.

---

## Solving Power Problems

---

<b>Problem</b>	<b>Possible Cause</b>	<b>Solution</b>
Computer will not turn on.	Battery is discharged and computer is not connected to a power source.	<ul style="list-style-type: none"><li>■ Charge the battery pack.</li><li>■ Replace the battery pack.</li><li>■ Connect the computer to an external power source.</li></ul>
	Battery is discharged and cables to the external power source are unplugged.	Ensure that cables connecting the computer and the external power source are plugged in properly.
Computer turned off while it was left unattended.	Computer initiated Hibernation because of a critical low battery condition.	<ul style="list-style-type: none"><li>■ Charge the battery pack.</li><li>■ Replace the battery pack.</li><li>■ Connect the computer to an external power source.</li></ul>
	The computer initiated Hibernation after a user-defined timeout expired.	Turn on the computer.

---

## Solving Screen Problems

Problem	Possible Cause	Solution
Characters on computer display are dim.	Computer is in direct light.	Move the computer or adjust the screen.
	The brightness control is not set properly.	Adjust the brightness control by pressing the <b>Fn+F10</b> hotkeys.
	You may have a screen saver or screen blanking utility installed.	Press any key to refresh the screen.
	Screen timeout was initiated.	Press any key to light the screen.
	System initiated Suspend after a user-defined timeout expired.	Press the suspend button to exit Suspend.
	Computer initiated a low battery Suspend or Hibernation.	<ul style="list-style-type: none"> <li>■ Replace the battery pack and exit Suspend or Hibernation.</li> <li>■ Connect the computer to an external power source and exit Suspend or Hibernation.</li> </ul>
Computer screen is blank and external monitor displays information.	Power Management, which controls Suspend and Hibernation, is disabled and the battery pack has discharged.	<ul style="list-style-type: none"> <li>■ Replace the battery pack and turn on the computer.</li> <li>■ Connect the computer to an external power source and turn on the computer.</li> </ul>
	Display was switched to the external monitor.	If you are running Windows 95/NT, press <b>Fn+F4</b> to display information on the computer screen; press <b>Fn+F4</b> again to display information simultaneously on both screens.
<b>Fn+F4</b> hotkey combination does not switch between internal and external displays.	Display switch is stuck.	Tap the switch.
	CRT or other display device is not connected properly.	Check your connections to ensure that an external device is connected properly.

---

## Solving USB Problems

---

<b>Problem</b>	<b>Possible Cause</b>	<b>Solution</b>
External device connected to a USB connector does not work.	The operating system limits external devices connected by USB to two tiers which can include no more than two hubs on the first tier and no more than one keyboard and one pointing device on the first or second tier.	Reduce the number of connected external USB devices to no more than two hubs on the first tier, and no more than one keyboard and one pointing device on the first or second tier.
External device connected to USB connector does not work during startup (before Windows 95 loads).	During startup, only two tiers are supported by the USB port. These tiers can include no more than two hubs on the first tier and no more than one keyboard and one pointing device on the first or second tier.	Use the external device only after Windows 95 has loaded. Reduce the number of connected external USB devices to no more than two hubs on the first tier, and no more than one keyboard and one pointing device on the first or second tier.
External devices in lower tiers do not work.	An unpowered hub is connected to another unpowered hub.	Use only powered hubs. Make sure that all unpowered hubs are immediately preceded by powered hubs in the USB chain.

---





# appendix A

## COMPAQ CUSTOMER SUPPORT

### Preparing for a Technical Support Call

If you cannot solve a problem using the troubleshooting tips in Chapter 12 and the online Troubleshooting help, you may need to call technical support. To receive the fastest possible solution when you call, follow the instructions in Chapter 10 to run the Compaq diagnostics utilities and have the following available when you call:

- The computer
- Serial number on the bottom of the computer
- Purchase date on invoice
- Conditions under which the problem occurred
- Error messages that occurred
- Hardware configuration
- Type of printer connected
- Hardware and software you are using
- Product identification number (PIN), which you entered when you set up the computer. (Click Start → Settings → Control Panel → System → General tab. Your PIN number is below your name.)
- Printed error message log from Computer Checkup (TEST), or a list of the devices and error messages received
- Configuration settings in View System Information (INSPECT), including contents of the system files

**NOTE** If you take your computer to a Compaq authorized reseller, dealer, or service provider for service, remember to provide the power-on and setup passwords if they are set.

# Worldwide Telephone Numbers

Locate your geographical area in the following table and use one of the telephone numbers for Compaq assistance

**General Information Numbers**—Product information, technical assistance, and the location of your nearest Compaq authorized dealer, reseller, or service provider.

**Technical Support Numbers**—Hardware technical support in analyzing system configuration and diagnostic problems or troubleshooting.

**Customer Support Numbers**—Information on service and support programs including warranty, product catalogs, and white papers.

**PaqFax Numbers**—Automatic facsimile response system for technical and product-specific information that is transmitted to any fax machine. PaqFax is available 24 hours a day.

**NOTE**Ⓢ Telephone numbers are subject to change without notice.

\*Indicates toll-free domestic numbers.

---

<b>Worldwide Telephone Numbers</b>		
<b>Location</b>	<b>Country Code</b>	<b>Telephone Number</b>
<b>Argentina</b>		
General Information	+54	-1-704-3800
Technical Support	+54	-1-704-3800
Fax	+54	-1-704-3809
<b>Australia</b>		
General Information		61-2-9911-1999
Technical Support		61-2-9911-1955
PaqFax		61-2-9911-1982
<b>Austria</b>		
General Information*		0222/8 78-16-16
Technical Support*		0222/8 78-16-16
Order Software Backup	+31	-55-38-43-39

---

*Continued*

**Worldwide Telephone Numbers** *Continued*

<b>Location</b>	<b>Country Code</b>	<b>Telephone Number</b>
<b>Belgium / Luxembourg</b>		
Compaq Care Center	Bel Lux	0903-99036 (45 BFr/min.) 089/89.232
General Fax	+32	(0)2/725 22 13
Infoline (resellers, brochures)	+32	(0)2/716 96 96
QuickLine (BBS)	+32	(0)2/716 95 92
Order Software Backup	+32	(0)2/716 96 78
Order Software Backup by Fax	+32	(0)2/716 96 79
<b>Brazil</b>		
General Information	+55	-(011) 5181-7866
<b>Canada</b>		
General Information		1-905-707-1715
Technical Support*		1-800-OKCOMPAQ (1-800-652-6672)
Customer Support*		1-800-263-5868
Order Software Backup*		1-800-952-7689
Battery Pack Recycling*		1-800-263-5868
<b>Caribbean</b>		
General Information		1-281-514-4220
Technical Support		1-281-518-2200
<b>Chile</b>		
General Information	+56	-2-274-1911
Technical Support	+56	-2-274-3007
<b>China</b>		
General Information	+86	-10-6831-3399
Technical Support	+86	-10-6834-6721
<b>Colombia</b>		
General Information	+57	-1-312-0201
Technical Support	+57	-1-345-0266
<b>Czech Republic</b>		
General Information	+420	-2-232-8772
Technical Support	+420	-2-232-8772

*Continued*

**Worldwide Telephone Numbers** *Continued*

<b>Location</b>	<b>Country Code</b>	<b>Telephone Number</b>
<b>Denmark</b>		
General Information	+45	-45-90-45-90
Technical Support	+45	-45-90-45-45
<b>Eastern Europe, Middle East, and Africa</b>		
Technical Support and Information	+353	-1-402-6833
Technical Support Fax	+353	-1-402-6855
<b>Ecuador</b>		
General Information	+59	-3-225-4343
<b>Finland</b>		
General Information	+358	(9) 615-599
Technical Support*		0203-206-720
QuickLine (BBS)	+358	(9) 615-559-870
<b>France</b>		
General Information	+33	-1-41-33-41-33
Technical Support	+33	-1-41-33-44-55
<b>Germany</b>		
		0,48 DM/min.
Hotline		0180/5 21 21 11
Hotline Fax		0180/5 21 21 17
Infoline		0180/3 22 12 21
Infoline Fax		0180/3 22 12 20
QuickLine		0180/5 21 21 18
FaxPaq		0180/5 21 21 19
Order Software Backup*		0130/81 10 81
<b>Hong Kong</b>		
General Information		852-28681382
Technical Support		852-90116633
PaqFax		852-28671648
<b>Hungary</b>		
General Information	+36	-1-457-3600
Technical Support	+36	-1-457-3682
<b>India</b>		
General Information		91-80-559-6023
PaqFax		91-80-559-8989
BBS		91-80-559-8900

*Continued*

**Worldwide Telephone Numbers** *Continued*

<b>Location</b>	<b>Country Code</b>	<b>Telephone Number</b>
<b>Israel</b>		
General Information	+972	-3-6363-444
Technical Support	+972	-3-6363-444
PaqFax	+972	-3-6396-601
<b>Italy</b>		
Presales Information*		167 464911
Technical Support	+39	(02) 69633281
BBS	+39	(02) 89200222
Order Software Backup*		167 859030
Fax	+39	(02) 69633282
<b>Japan</b>		
General Information*		0120-101-589
Technical Support*		0120-101-589
Windows 95 Support*		0120-505-589
Order Software Backup *		0120-250-589
FaxStation		81-3-5402-0991
<b>Korea</b>		
Product Information		82-2-523-3575
Customer Support		82-080-902-7777
<b>Malaysia</b>		
General Information		603-717-1188
Technical Support		603-718-1636
<b>Mexico</b>		
General Information	+52	-5-229-7900
Technical Support	+52	-5-229-7910
PaqFax	+52	-5-229-7920

*Continued*

**Worldwide Telephone Numbers** *Continued*

<b>Location</b>	<b>Country Code</b>	<b>Telephone Number</b>
<b>Netherlands</b>		
General Information		0182-565805
Customer Support*		06-91681616 (Dfl. 0.75/min)
Fax*		06-8991116 (Dfl. 0.40/min)
QuickLine Bulletin Board		0182-572366
<b>New Zealand</b>		
General Information		64-9-307-3969
<b>Norway</b>		
General Information	+47	-22-07-20-00
Technical Support	+47	-22-07-20-20
<b>Poland</b>		
General Information	+48	-2-630-3535
Technical Support	+48	-2-630-3535
<b>Portugal</b>		
General Information	+351	-1-412-8400
Technical Support	+351	-1-412-8460
Fax	+351	-1-412-0654
<b>Russia</b>		
General Information	+7	-095-967-1700
Technical Support	+7	-095-967-1700
PaqFax	+7	-095-967-1701
<b>Singapore</b>		
General Information		65-753-6688
Customer Support Center		65-750-3030
PaqFax		65-750-4514
<b>South Africa</b>		
General Information		27-11-728-6999
Technical Support		27-11-728-6999
<b>Spain</b>		
General Information	+34	-902.10.14.14
Technical Support	+34	-1-640-1302

*Continued*

**Worldwide Telephone Numbers** *Continued*

<b>Location</b>	<b>Country Code</b>	<b>Telephone Number</b>
<b>Sweden</b>		
General Information	+46	-8-703-5240
Technical Support	+46	-8-703-5240
PaqFax (h�mtfax)	+46	-8-703-5225
QuickLine (BBS)	+46	-8-703-5220
<b>Switzerland</b>		
General Information		0844 844 111
Technical Support		01/838 22 22 (German) 01/838 22 23 (French)
QuickLine Bulletin Board		01/838-24 21
Order Software Backup		0800 556 206
<b>Taiwan</b>		
General Information		886-2-7351000
Technical Support		886-2-3761170
BBS		886-2-3761175
<b>Thailand</b>		
General Information		62-2-679-6222
<b>United Arab Emirates (Dubai)</b>		
General Information	+97	14 -818100
<b>United Kingdom</b>		
General Information		0990-134456
FaxPaq		0181-332-3550
QuickLine Bulletin Board		0181-332-9499
<b>United States</b>		
Product Information*		1-800-345-1518
Technical Support*		1-800-OKCOMPAQ (1-800-652-6672)
PaqFax*		1-800-345-1518, Option 1
Download Facility (modem access only)		1-281-518-1418
Order Software Backup*		1-800-952-7689
Battery Pack Recycling*		1-800-524-9859
<b>Venezuela</b>		
General Information	+58	-2-953-6944





# appendix **B**

## REGULATORY NOTICES

Throughout these regulatory notices, Compaq products are referred to by their regulatory agency series numbers.

### Regulatory Agency Series Numbers

Regulatory agencies worldwide use agency series numbers for product identification. Each approved product displays the assigned agency series number. To ensure continued safe and reliable operation, use your portable computer only with the products listed below:

<b>Product</b>	<b>Agency Series Number</b>
<b>Battery Charger</b>	Series <del>2803</del>
<b>Battery Pack</b>	Series <del>2911</del>
<b>ArmadaStation</b>	Series <del>2805</del>
<b>Armada MiniStation</b>	Series <del>2806</del>
<b>Modem (Engines) Cables</b>	Series 575, 576, 577
<b>Automobile/Aircraft Adapter</b>	Series 2874
<b>AC Adapter</b>	Series <del>2912</del> , <del>2912A</del>

# Federal Communications Commission Notice

This equipment has been tested and found to comply with the limits for a Class B digital device, pursuant to Part 15 of the FCC Rules. These limits are designed to provide reasonable protection against harmful interference in a residential installation. This equipment generates, uses, and can radiate radio frequency energy and, if not installed and used in accordance with the instructions, may cause harmful interference to radio communications. However, there is no guarantee that interference will not occur in a particular installation. If this equipment does cause harmful interference to radio or television reception, which can be determined by turning the equipment off and on, the user is encouraged to try to correct the interference by one or more of the following measures:

- Reorient or relocate the receiving antenna.
- Increase the separation between the equipment and receiver.
- Connect the equipment into an outlet on a circuit different from that to which the receiver is connected.
- Consult the dealer or an experienced radio or television technician for help.

## Modifications

The FCC requires the user to be notified that any changes or modifications made to this device that are not expressly approved by Compaq Computer Corporation may void the user's authority to operate the equipment.

## Cables

Connections to this device must be made with shielded cables with metallic RFI/EMI connector hoods to maintain compliance with FCC Rules and Regulations.

## **Declaration of Conformity for Products Marked with the FCC Logo (United States only)**

This device complies with Part 15 of the FCC Rules. Operation is subject to the following two conditions: (1) this device may not cause harmful interference, and (2) this device must accept any interference received, including interference that may cause undesired operation.

For questions regarding this declaration, write

Compaq Computer Corporation  
P. O. Box 692000, Mail Stop 510101  
Houston TX 77269-2000  
or call 281-514-3333

To identify your product, refer to the part, series, or model number found on the product.

If you have questions about your product that are *not* related to this declaration, please write

Compaq Computer Corporation  
P. O. Box 692000, Mail Stop 530113  
Houston TX 77269-2000

or call Compaq

Product Information Center	1-800-345-1518
Technical Support	1-800-OKCOMPAQ (1-800-652-6672)

## **Canadian Notice**

This Class B digital apparatus meets all requirements of the Canadian Interference-Causing Equipment Regulations.

## **Avis Canadien**

Cet appareil numérique de la classe B respecte toutes les exigences du Règlement sur le matériel brouilleur du Canada.

## European Notice

Products with the CE Marking comply with both the EMC Directive (89/336/EEC) and the Low Voltage Directive (73/23/EEC) issued by the Commission of the European Community.

Compliance with these directives implies conformity to the following European Norms:

- EN55022 (CISPR 22)—Electromagnetic Interference
- EN50082-1 (IEC801-2, IEC801-3, IEC801-4)—  
Electromagnetic Immunity
- EN60950 (IEC950)—Product Safety

## Japanese Notice

この装置は、情報処理装置等電波障害自主規制協議会（VCCI）の基準に基づくクラスB情報技術装置です。この装置は、家庭環境で使用することを目的としていますが、この装置がラジオやテレビジョン受信機に近接して使用されると、受信障害を引き起こすことがあります。

取扱説明書に従って正しい取り扱いをして下さい。

## German Ergonomics Notice

The Compaq 2910 agency series of computers meet the requirements of ZH 1/618 (German Safety Regulations for Display Work Places in the Office Sector) when used in conjunction with docking bases, keyboards, and monitors that bear the “GS” approval mark. The Compaq 2910 agency series of computers in a stand-alone mode are not intended for continuous use in an office environment.

## Airline Travel Notice

Use of electronic equipment aboard commercial aircraft is at the discretion of the airline.

# Energy Star Compliance

This computer is compliant with the U.S. Environmental Protection Agency (EPA) Energy Star Computers Program 2.0. The EPA Energy Star logo does not imply endorsement by the EPA. As an Energy Star Partner, Compaq Computer Corporation has determined the product meets the Energy Star guidelines for energy efficiency.

## Battery Notice



**WARNING:** This computer contains a lithium ion battery pack. There is a risk of fire and chemical burn if the battery pack is handled improperly. Do not disassemble, crush, puncture, short external contacts, dispose in water or fire, or expose it to temperatures higher than 60°C (140°F). Replace only with the Compaq battery pack for this computer.

---

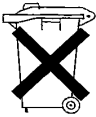

In North America, dispose of nickel metal hydride or lithium ion batteries by taking advantage of the Compaq battery recycling program. You will be provided with a postage-paid battery pack mailer preaddressed to a reclamation facility where the metals are recycled. Call the telephone number listed for your location in Appendix A for more information.

In Europe, do not dispose of batteries with general household waste. Dispose of or recycle them by using the public collection system or returning them to Compaq, your authorized Compaq partners, or their agents.

## Power Cords

If you were not provided with a power cord for your computer or for an AC power accessory intended for use with your computer, you should purchase a power cord that is approved for use in your country.

The power cord must be rated for the product and for the voltage and current marked on the product's electrical ratings label. The voltage and current rating of the cord should be greater than the voltage and current rating marked on the product. In addition, the diameter of the wire must be a minimum of 0.75 mm<sup>2</sup>/18AWG, and the length of the cord must be between 5 feet (1.5 m) and 6½ feet (2 m). If you have questions about the type of power cord to use, contact your Compaq authorized service provider.

A power cord should be routed so that it is not likely to be walked on or pinched by items placed upon it or against it. Particular attention should be paid to the plug, electrical outlet, and the point where the cord exits from the product.

## Laser Safety

All Compaq systems equipped with laser products comply with appropriate safety standards, including IEC 825. With specific regard to the laser, the equipment complies with laser product performance standards set by government agencies for Class 1 laser products. It does not emit hazardous light; the beam is totally enclosed during all modes of customer operation and maintenance.

### CDRH Regulations

The Center for Devices and Radiological Health (CDRH) of the U.S. Food and Drug Administration implemented regulations for laser products on August 2, 1976. These regulations apply to laser products manufactured from August 1, 1976. Compliance is mandatory for products marketed in the United States.



**WARNING: Use of controls or adjustments or performance of procedures other than those specified herein or in the laser product installation guide may result in hazardous radiation exposure.**

---



This system is classified as a Class 1 laser product. This label appears on the laser product.

## Laser Information

Laser Type:	Semiconductor GaAlAs
Wave Length:	$780 \pm 35$ nm
Divergence Angle:	$53.5^\circ \pm 1.5^\circ$
Output Power:	Less than 0.2mW or $10,869 \text{ W}\cdot\text{m}^{-2}\cdot\text{sr}^{-1}$
Polarization:	Circular
Numerical Aperture:	$0.45 \pm 0.04$

Only authorized technicians trained by Compaq should attempt to repair this equipment. All troubleshooting and repair procedures are detailed to allow only subassembly/module level repair. Because of the complexity of the individual boards and sub-assemblies, no one should attempt to make repairs at the component level or to make modifications to any printed wiring board. Improper repairs can create a safety hazard.

## Safety Precautions for Modems

Always follow these basic safety precautions when using a modem or telephone that is not cordless.



**WARNING:** To reduce the risk of personal injury, electric shock, or fire:

- Never connect or use a modem or telephone during a lightning storm. There may be a remote risk of electric shock from lightning.
- Never connect or use a modem or telephone in a wet location.
- Never use a modem or telephone to report a gas leak in the vicinity of the leak.
- Always disconnect the modem cable before opening the equipment enclosure or touching an uninsulated modem cable, jack, or internal components.

## U.S. Regulations Governing the Use of Modems

This equipment complies with Part 68 of the FCC rules. Located on the bottom of the computer is a label that contains, among other information, the FCC Registration Number and Ringer Equivalence Number (REN) for this equipment. Upon request, you must provide this information to your telephone company.

The REN is useful to determine the quantity of devices you may connect to your telephone line and still have all of those devices ring when your telephone number is called. In most areas (but not all), the sum of the RENs of all devices connected to one line should not exceed five (5.0). To be certain of the number of devices you may connect to your telephone line, as determined by the REN, you should contact your local telephone company to determine the maximum REN for your calling area.

The REN for this device is 0.7B.

If your telephone equipment causes harm to the telephone network, the telephone company may discontinue your service temporarily. If possible, they will notify you in advance. But, if advance notice is not practical, you will be notified as soon as possible. You will also be informed of your right to file a complaint with the FCC.

Your telephone company may make changes in its facilities, equipment, operations, or procedures that could affect the proper functioning of your equipment. If they do, you will be notified in advance to give you an opportunity to maintain uninterrupted telephone service.

If you experience trouble with this telephone equipment, contact your local telephone company for information on obtaining service or repairs. The telephone company may ask that you disconnect this equipment from the network until the problem has been corrected or until you are sure that the equipment is not malfunctioning.

This equipment may not be used on coin service provided by the telephone company. Connection to party lines is subject to state tariffs.

For the Compaq Customer Support Center and your nearest Compaq authorized reseller in North America, call 1-800-345-1518 or write:

Compaq Customer Support Center  
P.O. Box 692000  
Houston, Texas 77269-2000



## Telephone Consumer Protection Act of 1991

The Telephone Consumer Protection Act of 1991 makes it unlawful for any person to use a computer or other electronic device to send any message via a telephone facsimile machine unless such message clearly contains, in a margin at the top or bottom of each transmitted page, or on the first page of the transmission, the date and time it is sent and an identification of the business, or entity, or individual sending the message and the telephone number of the sending machine or such business, or entity, or individual.

### Canadian Regulations Governing the Use of Modems

**NOTE:** The Industry Canada label identifies certified equipment. This certification means that the equipment meets certain telecommunications network protective, operational, and safety requirements. The Department does not guarantee the equipment will operate to the user's satisfaction.

Before installing the equipment, users should ensure that it is permissible to be connected to the facilities of the local telecommunications company. The equipment must also be installed using an acceptable method of connection. In some cases, the company's inside wiring associated with a single line individual service may be extended by means of a certified connector assembly (telephone extension cord). The customer should be aware that compliance with the above conditions may not prevent degradation of service in some situations.

Repairs to certified equipment should be made by an authorized Canadian maintenance facility designated by the supplier. Any repairs or alterations made by the user to this equipment, or equipment malfunctions, may give the telecommunications company cause to request the user to disconnect the equipment.

Users should ensure for their own protection that the electrical ground connections of the power utility, telephone lines, and internal metallic water pipe system, if present, are connected together. This precaution may be particularly important in rural areas.



**CAUTION: Users should not attempt to make such connections themselves, but should contact the appropriate electric inspection authority or an electrician.**

---

The Load Number (LN) assigned to each terminal device denotes the percentage of the total load to be connected to a terminal loop which is used by the device to prevent overloading. The termination on a loop may consist of any combination of devices subject only to the requirement that the total of the Load Numbers of all devices does not exceed 100. An alphabetic suffix is also specified in the Load Number for the appropriate ringing type (A or B), if applicable. For example, LN = 20 A designates a Load Number of 20 and an "A" type ringer.

The Load Number for this device is 5B.

For the location of the authorized Canadian maintenance facility nearest you, call 1-800-263-5868 or contact:

Compaq Canada, Inc.  
45 Vogell Road  
Richmond Hill, Ontario LA5B 3P6

## AUSTEL Requirements



**CAUTION: Failure to set the modem, and any communications software used with the modem, to the values contained in the Data/Fax Modem documentation will result in the modem being operated in a non-compliant manner. Consequently, there would be no permit in force for this equipment, and the Telecommunications Act ~~1997~~ prescribes a penalty of \$12,000 for the connection of non-permitted equipment.**

---

## Auto Dialing with the Modem

1. When entering telephone numbers, ensure that the number that appears on the screen is correct before beginning to dial.
2. Some parameters required for compliance with AUSTEL specifications are dependent on the Telecommunications apparatus provided with the Compaq Armada 7400 Family of Personal Computers. The Compaq Armada 7000 Series II (Series 577) modem shall be set to operate within the following limits for compliance with AUSTEL Specifications.

When the user manually initiates a call via equipment connected to the Compaq personal computer, the equipment shall operate within the following restrictions:

- (a) Without call progress detection—a maximum of three calls (original plus two retries).
- (b) With call progress detection (which ensures the line will be released after detection of tones indicating the call will not be successful)—a maximum of ten calls (original plus nine retries).
- (c) If the series of calls noted in a or b are unsuccessful, no further attempts shall be made to obtain the required number within the next 30 minutes (unless manually initiated).

**NOTE:** Failure to meet the above requirements may negate user rights under the AUSTEL Terms of Service.

## U.K. BABT User Information

### Safety

The Compaq Armada 7000 Series II (Series 577) modem is intended for use in the Compaq Armada 7400 Family of Personal Computers. For the purposes of BABT approval, the Compaq Armada 7000 Series II modem is classified as a host-independent product.

The following information characterizes the requirements of the host system in order to maintain the reliable use of the Compaq Armada 7000 Series II (Series 577) modem:

- The fax/voice modem requires a power supply voltage of 5VDC  $\pm$  5%, 12VDC  $\pm$  5%, or -12VDC  $\pm$  5%.
- The host computer must provide a maximum of 950 mW (U.K.) from the +5VDC power supply, and a maximum of 50 mW from the -12VDC power supply and the +12VDC power supply.
- The host apparatus must provide adequate power for the modem and any other auxiliary apparatus drawing power from it.
- Failure to provide modem user's instructions with the host computer will INVALIDATE modem approval.
- The modem is approved only for installation in a host and with host attachments that are either type approved for such apparatus or, if supplied after 1st March 1989, are marked with or supplied with a statement that the host is supplied under General Approval Number NS/G/1234/J/100003.
- Connections to and from the modem card are made via the following port: DTE port (SELV) 80-pin edge connector on modem PCB.
- Ports for SELV circuitry should only be connected to like SELV circuitry ports.

### **Telephone Network Connection**

- The modem is suitable for connection to the Public Switched Telephone Network (PSTN) direct exchange lines and relevant branch systems (PBXs).
- A ringer equivalent number (REN) is a value given to all apparatus to be connected to the PSTN. Its value can be taken and used to calculate the maximum number of equipment

items that can be connected in parallel without impairing the performance of the standard bell circuit.

- $REN = 3/n$  where  $n$  is the maximum number of units that may be used in parallel.
- The maximum REN of a line is 4; therefore, the total REN of all apparatus connected to the line (obtained by summing the individual REN values) should not exceed 4. This value includes any BT-provided instrument, each of which is assumed to have REN value of 1.0 unless otherwise stated. Exceeding the  $REN = 4$  value may cause your telephone(s) to ring weakly or not ring at all.
- Only one modem should be connected to a telephone line. Connecting a modem in parallel with one or more telephone instruments is not allowed.
- The REN for this piece of equipment is 1.0.
- The exchange should provide facilities for either loop disconnect (pulse) dialing or multifrequency (tone) dialing. The modem can be configured to operate with either system.
- During dialing, this apparatus may tinkle the bells of other telephones using the same line. This is not a fault, and we advise you not to call the Fault Repair Service.
- The Compaq Armada 7000 Series II (Series 577) modem specified in this guide is for the Compaq Armada 7400 Family of Personal Computers.

- This apparatus has been approved for the following facilities:
  - Simple modem
  - Facsimile
  - Telephone answering machine functions
  - Speakerphone functions
  - Automatic call initiation
  - Detection of initial proceed indication
  - Automatic dialing
  - Tone detection of busy tone, dial tone, or number unobtainable tone
  - Auto clear from the call origination end
  - Loop disconnect (pulse) dialing
  - Multifrequency (tone) dialing

Any other usage will invalidate the approval of the apparatus if, as a result, it ceases to conform to the standards against which approval was granted.

All apparatus connected to this modem and, thereby, connected directly or indirectly to the British Telecom Public Switched Telephone Network, must be approved apparatus as defined in Section 16 of the British Telecommunications Act of 1981.

Although this equipment can use either loop disconnect or DTMF signaling, only the performance of the DTMF signaling is subject to regulatory requirements for correct operation. It is therefore strongly recommended that the equipment be set to use DTMF signaling for access to public or private emergency services. DTMF signaling also provides faster call setup.



**CAUTION: The Compaq Armada 7000 Series II (Series 577) modem may not be used on extension wiring that makes use of plug pins 1 & 6. If in doubt, advice must be obtained from a competent telecommunications engineer.**

---

Difficulties may occasionally be experienced from other apparatus connected to the BT PSTN via the Compaq Armada 7000 Series II modem apparatus. Such difficulties may include the following:

- Difficulty in making calls
- Problems in telephone conversion being experienced by both parties to the call



**CAUTION: Initially, normal operation will be possible. However, changes to or modernization of the network may result in the apparatus being connected to a network service with which it was not designed to be compatible. Failure of the apparatus to work under these circumstances may not be the responsibility of the network operator.**

---

If the above mentioned difficulties are experienced, please contact your product supplier or your authorized Compaq reseller in the United Kingdom.

This device is intended for auto-answering of incoming calls. Under normal conditions callers will be accustomed to calls being answered within 10 seconds, and a majority of callers will abandon calls that are not answered within 45 seconds.

There are several options available for auto-answering operation. The default setting is for two incoming rings. This is the recommended setting for normal operation by most computer users.

## **Auto Dialing with the Modem**

When entering telephone numbers, ensure that the number that appears on the screen is correct before beginning to dial.

## **Approval Statements**

The following lists the modem approval statements:

- This (Series 577) modem is approved as a host independent product. This approval number is a general approval number.
- APPROVED for connection to the telecommunications systems specified in the instructions for use, subject to the conditions set out in them.

DGT No. NS/5141/3/V/607050.

## New Zealand Modem Statements

The grant of a Telepermit for any item of terminal equipment indicates only that Telecom has accepted that the item complies with minimum conditions for connection to its network. It indicates no endorsement of the product by Telecom, nor does it provide any sort of warranty. Above all, it provides no assurance that any item will work correctly in all respects with another item of Telepermitted equipment of a different make or model, nor does it imply that any product is compatible with all of Telecom's network services.

This equipment is not capable, under all operating conditions, of correct operation at the higher speeds for which it is designed. Telecom will accept no responsibility should difficulties arise in such circumstances.

This device is equipped with pulse dialing while the Telecom standard is DTMF tone dialing. There is no guarantee that Telecom lines will always continue to support pulse dialing.

Use of pulse dialing, when this equipment is connected to the same line as other equipment, may give rise to bell tinkle or noise and may also cause a false answer condition. Should such problems occur, the user should not contact the Telecom Faults Service.

Some parameters required for compliance with Telecom's Telepermit requirements are dependent on the equipment (PC) associated with this device. The associated equipment shall be set to operate within the following limits for compliance with Telecom's Specifications:

- (a) There shall be no more than 10 call attempts to the same number within any 30 minute period for any single manual call initiation, and
- (b) The equipment shall go on-hook for a period of not less than 30 seconds between the end of one attempt and the beginning of the next attempt.

This equipment should not be used under any circumstances which may constitute a nuisance to other Telecom customers.

This equipment shall not be set to make automatic calls to the Telecom '111' Emergency Service.



# Speciale gebruiksinstructies voor Nederland

## Aansluitfactor

1. Het modem is geschikt voor aansluiting op het openbare geschakelde telefoonnetwerk en op (analoge) telefooncentrales binnen bedrijven en instellingen.
2. De aansluitfactor is een waarde die wordt toegekend aan alle apparaten die op het openbare telefoonnetwerk kunnen worden aangesloten. Met deze waarde kan worden berekend hoeveel apparaten maximaal parallel kunnen worden geschakeld. De maximale aansluitfactor van een lijn is 5. De aansluitfactor van alle apparaten die zijn aangesloten op één lijn mag daarom nooit hoger zijn dan 5. U berekent de aansluitfactor door de waarden van de afzonderlijke apparaten op te tellen.
3. De aansluitfactor voor dit apparaat is 1,0.

## Wachten op kiestoon

Het modem moet altijd eerst een kiestoon ontvangen voordat wordt geprobeerd een verbinding tot stand te brengen. Deze vereiste kan niet worden uitgeschakeld met de opdracht ATX<n>.

## Handenvrij bellen

Handenvrij bellen is toegestaan bij gebruik van een aparte (goedgekeurde) telefoon set.

## Användarinstruktioner i överensstämmelse med svenska krav

### Uppringningskod P och T

Modemet till Compaq Armada 7000 Series (Series 577) Modem stödjer inte pulssignalering. Både uppringningskod P (pulssignalering) och T (tonsignalering) är jämförbara och vill tvinga modemet att använda tonsignalering.

# Hinweis für die Benutzung in der Bundesrepublik Deutschland

Dieses Gerät ist mit einem 2-adrigen Anschlußkabel mit TAE-Stecker **ohne Kodierung N oder F** ausgestattet. Es ist zum Betrieb als einzige Endeinrichtung am Netzanschluß vorgesehen. Der Stecker kann in F-kodierte und N-kodierte Anschlußdosen gesteckt werden.

Das Gerät hat keine weiterführenden Sprechadern. Weitere Endeinrichtungen, die sich an dem Telefonanschluß befinden, werden beim Einstecken des Gerätes unter Umständen von der Leitung getrennt.

## Benutzerhinweise für besondere

### Bestimmungen in Österreich

#### Hinweis für die Benutzung in Österreich

Sofern Sie das Compaq Armada 7000 Series (Series 577) Modem an einer Nebenstellenanlage benutzen wollen, erkundigen Sie sich bitte bei Ihrem Fachhändler nach der Möglichkeit, die Amtsholung einzustellen.

#### Wahlsperre

Ein Modem darf, beispielsweise im "unbeaufsichtigten Betrieb", nicht pausenlos dieselbe Rufnummer anwählen (Wahlsperre).

Nach zwölf erfolglosen Wählversuchen innerhalb einer Stunde gibt das Modem die Meldung "BLACK-LISTED" (Wahlsperre) aus. Danach ist jeder weitere Wählversuch blockiert.

Die Wahlsperre wird wieder aufgehoben, wenn eines der drei folgenden Ereignisse eintritt:

- Sie starten den Computers neu (reboot), oder
- Ablauf einer Stunde, oder
- Sie erhalten einen Anruf.

# *appendix* **C**

## ELECTROSTATIC DISCHARGE

A discharge of static electricity from fingers or other electrostatic conductors may damage electronic components. Before handling electrostatic-sensitive components, discharge static electricity by one of the methods described in this appendix.

### ***Preventing Electrostatic Discharge***

#### ***When Handling Removable Drives***

To prevent electrostatic damage to removable drives, observe these precautions:

- Before handling a removable drive, discharge static electricity by touching the unpainted metal surface or lug nuts on the connectors on the back of the computer.
- Avoid touching connector pins on the computer and on the removable drive.
- Keep a removable drive in its carrying case until you are ready to insert it into a drive bay.

#### ***When Installing Internal Components***

To prevent electrostatic damage when installing internal components, observe these precautions:

- Keep components in their electrostatic-safe containers until you are ready to install them.
- Have everything needed for the installation within reach so that you do not have to leave the area after beginning installation.

- Use nonmagnetic tools.
- Before touching an electronic component, discharge static electricity by one of the grounding methods described later in this appendix. If you must leave the area during installation, remember to reground yourself before resuming installation.
- Avoid touching pins, leads, and circuitry. Handle electronic components as little as possible.
- If you remove a component, place it in an electrostatic-safe container.

## Grounding Methods

There are several methods for grounding. Use one or more of the following grounding methods when installing components in the computer or expansion base.

- Touch the unpainted metal surface or lug nuts on the connectors on the back of the computer or expansion base. Avoid touching connector pins. If installation instructions direct you to unplug the computer or expansion base, unplug it after being properly grounded and before removing the cover.
- Touch an exterior unpainted metal surface of equipment that is connected to an electrical outlet by a grounding plug.
- Use a wrist strap connected by a ground cord to the computer chassis. Wrist straps are flexible grounding straps with a minimum of 1 megohm  $\pm$  10 percent resistance in the ground cords. To provide proper ground, wear the strap snug against the skin.

**NOTE:** If you need more information about static electricity or assistance with product installation, contact your Compaq authorized dealer, reseller, or service provider.

# *appendix* **D**

## **SPECIFICATIONS**

The following guidelines provide a safe operating environment for your computer.

<b>Operating Environment</b>		
	<b>U.S.</b>	<b>Metric</b>
<b>Temperature</b>		
Operating	50 to 104°F	10 to 40°C
Nonoperating	-4 to 140°F	-20 to 60°C
<b>Relative Humidity (noncondensing)</b>		
Operating	10 to 90%	
Nonoperating	5 to 90%—38.7°C Maximum Wet Bulb	
<b>Maximum Altitude (unpressurized)</b>		
Operating	0-10,000 ft	3.05 km
Nonoperating	0-30,000 ft	9.14 km
<b>Rated Input Power</b>		
Operating Voltage	100-120/220-240 VAC RMS	
Operating Current	1.2/0.6 A RMS	
Operating Frequency Range	50 to 60 Hz AC	
<b>NOTE:</b> This product is designed for IT power systems in Norway with phase-to-phase voltage not exceeding 240 Vrms.		
<b>Computer Dimensions</b>		
Height	1.6 in	4.1 cm
Width	12.5 in	31.8 cm
Depth	9.6 in	24.4 cm



# INDEX

## A

- AC Energy Saver, 5-2
- accuracy
  - battery gauge, 4-3
- adapter, 4-6
  - AC Adapter, 1-3, 4-5
  - automobile/aircraft, 4-6
- adjusting computer using tilt feet, 2-9
- airport security, 11-2
- Armada 7000 Series II Modem, 8-2
- Armada 7300/7400 Hard Drive
  - MultiBay Adapter, 6-1
- Asset Management, 9-14
- asset tag number, 9-14
  - changing, 9-14
- AT commands, 8-1, 8-7
- audio, 9-2, 9-4
  - connections, 9-2
  - problems, 12-2
  - volume, 9-4
- automatically initiated Hibernation, 5-8
- automobile/aircraft adapter, 4-6

## B

- battery bay, 2-1
- battery components, 4-2
- battery gauge, 3-8, 4-3
  - access, 3-8
  - accuracy, 4-3
- battery pack, 4-2, 4-7, 4-9, 4-11, 5-8
  - charging, 4-3
  - disposing of, 4-11
  - increasing life, 4-9
  - inserting, 4-9
  - maximizing life, 4-10
  - power management, 5-8
  - recycling, 4-11
  - removing, 4-8
  - storing, 4-9
- battery/battery gauge problems, 12-4
- beeps, 4-4, 4-10
  - low battery, 4-4
- boot (startup) sequencing, 10-2
- bottom components, 2-8

## C

- cable lock, 7-15
- CardWare, 9-10
- caring for computer, 11-1
- CD, 6-11
  - inserting, 6-10
- CD-ROM drive
  - inserting into MultiBay, 6-9
  - removing from MultiBay, 6-8
- cellular phone, 8-8
  - connecting, 8-9
  - programming, 8-9
  - register with modem, 8-9
  - setting up, 8-9
- changing passwords, 7-9
  - power-on, 7-9
  - setup, 7-11
  - symbols, 7-11
- charging battery packs, 4-3
- checklist for solving problems, 12-1
- cleaning screen, 11-1
- clearing display, 3-8
- COM port setting, 8-2
- communications software, 8-2
- compact disc, 6-10
- compact disc/CD-ROM drive problems, 12-6
- Compaq Diagnostics, 10-8, A-1
- Compaq phone numbers, A-2
- Compaq support, A-1
- Compaq Utilities, 10-1
- components, 2-1, 3-2, 4-2
  - audio, 9-3
  - keyboard, 3-2
- computer
  - serial number, A-1
- computer care, 5-1, 11-1
- Computer Checkup (TEST), 10-4
- Computer Setup, 10-1
  - exiting, 10-3
  - running, 10-3
- Configuration Management, 9-16
- conventions used in guide, xiii
- critical low battery, 5-8
- cursor keys, 3-2
- customer support, A-2

# D

- damage, preventing
  - from electrostatic discharge, C-1
  - internal components, C-1
  - removable drives, C-1
- default settings, computer, 10-6
- deleting, 7-9, 7-11
  - passwords, 7-11
  - power-on password, 7-9
  - setup password, 7-11
  - user password, 7-6
- diagnostics, 10-1, 10-4, 10-8
- digital line, 8-3
- disabling, 5-8, 7-13, 9-12
  - devices, 7-14
  - Hibernation, 4-4, 5-8
  - keyboard and pointing device, 3-8
  - PC Card slots, 9-12
- diskette
  - capacities, 6-13
  - inserting into, 6-14
- diskette drive
  - inserting diskette into, 6-14
  - inserting into MultiBay, 6-13
  - problems, 12-7
  - removing diskette from, 6-15
  - removing from MultiBay, 6-12
- display, 2-1
- docking connector, 2-2
- DriveLock
  - changing master password, 7-5
  - changing user password, 7-4
  - deleting passwords, 7-6
  - master password, 7-2
  - overview, 7-2
  - removing protection, 7-6
  - user password, 7-2
  - using, 7-2
- drives, 6-1
  - caring for, 6-2
  - inserting CD-ROM drive into MultiBay, 6-9
  - inserting diskette drive, 6-13
  - inserting hard drive into hard drive bay, 6-5

- inserting hard drive into MultiBay, 6-7
- removable, 6-1, 6-2
- removing CD-ROM drive from MultiBay, 6-8
- removing diskette drive from MultiBay, 6-12
- removing hard drive from hard drive bay, 6-4
- removing hard drive from MultiBay, 6-6

# E

- EasyPoint III, 3-11
  - replacing cap, 3-12
  - using, 3-11
- electrostatic discharge, 6-2, C-1
- enabling and disabling Hibernation, 5-8
- enabling devices, 7-14
- energy saving, 3-8, 5-2, 5-7
- establishing DriveLock protection, 7-3
- exiting
  - computer setup, 10-3
  - Hibernation, 5-9
  - Suspend, 5-6
- external microphone, 9-3
- external power, 4-4
- external speakers, 9-4

# F

- factory default settings, 10-6
- fan, 2-3
- Fault Management, 9-15
- Fn** key, 3-2
- front components, 2-1
- function keys, 3-2

# G

- grounding methods, C-2



# H

- hard drive, 5-7
  - inserting into hard drive bay, 6-5
  - inserting into MultiBay, 6-7
  - problems, 12-8
  - removing from hard drive bay, 6-4
  - removing from MultiBay, 6-6
- hard drive bay, 2-1, 6-3
- hard drive boot sequencing, 10-2
- hard drive problems, 12-8
- headphone jack, 2-4
- Hibernation
  - benefits of using, 5-7
  - exiting, 4-4
  - initiating, 5-8
- hotkeys
  - accessing battery gauge, 3-7
  - accessing brightness control, 3-7
  - accessing embedded numeric keypad, 3-7
  - accessing power management, 3-7
  - adjusting system warning beeps, 3-7
  - functions, 3-7
  - quick reference, 3-7
  - stretching text, 3-7
- HyperTerminal, 8-2, 8-9

# I

- increasing battery life, 4-9
- infrared port, 2-2
- infrared problems, 12-9
- infrared, connecting infrared-equipped computers, 9-6
- initiating, 5-5, 5-8
  - Hibernation, 5-8
  - QuickLock/QuickBlank with hotkeys, 3-8
  - Suspend, 5-5
- inserting, 9-9
  - CD-ROM drive, 6-9
  - diskette drive, 6-13
  - diskette into, 6-14
  - hard drive into hard drive bay, 6-5
  - into MultiBay, 6-7
  - PC Card, 9-9

# INSPECT, 10-5

- Intelligent Manageability, 9-14
  - Asset Management, 9-14
  - Configuration Management, 9-16
  - Fault Management, 9-15
  - Security Management, 9-16
- internal microphone, 9-3
- internal speakers, 9-4
- Internet address, 8-1
- inventory information, 9-14

# K

- Kensington cable lock, 7-15
- keyboard components, 3-2
- keyboard/mouse connector, 2-2
- keyboard/numeric keypad problems, 12-11
- keypad
  - embedded numeric, 3-9
- keys, programmable, 3-3

# L

- leaving on computer, 5-1
- left side components, 2-3
- levels (power management), 5-3
- lights, 2-6
  - blinking, 4-4
- line-in jack (stereo), 9-2
- locating components, 3-2
  - bottom, 2-8
  - front, 2-1
  - left side, 2-3
  - rear, 2-2
  - right side, 2-4
  - top, 2-6
- locking computer, 7-15
- low battery, 4-4, 4-7, 5-8
  - condition, 4-4
  - identifying, 4-4
  - resolving, 4-7

# M

- master password, 7-2
  - deleting, 7-6
- microphone, 9-3
  - jack, 2-4
- microphone jack, 9-2
- modem
  - compatibility, 8-10
  - connecting, 8-3
  - overview, 8-1
  - problems, 12-11
  - register cellular, 8-9
  - software, 8-2
- modem cable
  - country-specific, 8-5
- mouse buttons, 2-7
- mouse/keyboard connector, 2-2
- MultiBay, 6-6
- MultiBay weight saver, 6-3

# N

- number, serial, A-1
- numeric keypad, 3-2, 3-9
  - accessing, 3-9

# O

- operating temperatures, 11-2

# P

- PaqFax, A-2
- parallel connector, 2-2
- passwords, 3-8, 7-1, 7-6, 7-9, 7-11
  - change/delete symbols, 7-11
  - changing, 7-4, 7-9, 7-11
  - deleting, 7-9, 7-11
  - using, 7-6, 7-9
  - Windows 95/NT, 7-7

# PC Card

- device drivers, 9-12
- inserting, 9-9
- problems, 12-14
- removing, 9-11
- slots, 2-5
- software caution, 9-12
- types, 9-8
- Zoomed Video, 9-13
- phone numbers, worldwide, A-2
- PIN dialing, 8-6
- pointing device, 2-7, 3-2, 3-11
  - replacing cap, 3-12
  - using, 3-11
- pointing device cap, 3-12
- port
  - infrared, 2-2
  - USB, 2-2
- power
  - conservation, 3-8
  - management, 3-8, 5-2, 5-8
  - management levels, 5-3
  - problems, 12-17
- power light, 12-4
- power switch, 2-6
- power-on password, 3-8, 7-9
  - changing, 7-9
  - deleting, 7-9
  - setting, 7-7
  - using, 7-6
- problems, checklist, 12-1
- product identification number (PIN), A-1
- programmable keys, 3-3
  - adding schemes, 3-5
  - assigning, 3-4
  - unassigning, 3-5
  - using, 3-3
- protecting computer, 7-1, 7-15
- protecting information, 7-1

# Q

- quick controls, 7-12
- QuickLock/QuickBlank, 3-8, 7-12
  - hotkeys, 3-7
  - initiating, 3-8

## R

- rear components, 2-2
- regulatory notices, B-1
- release latch
  - battery, 2-8
  - display, 2-3
  - MultiBay, 2-8
- removable drives, C-1
  - caring for, 6-2
  - MultiBay weight saver, 6-3
  - using, 6-1
- removing, 3-6, 6-3, 9-11
  - CD-ROM drive, 6-8
  - compact disc, 6-11
  - diskette, 6-15
  - diskette drive, 6-12
  - hard drive from hard drive bay, 6-4
  - hard drive from MultiBay, 6-6
  - PC Card, 9-11
- resolving low battery condition, 4-4
- restricting access to computer, 7-14
- right side components, 2-4
- RJ-11 jack, 8-3
- running Computer Setup, 10-3

## S

- safety standards, 11-2
- saving energy, 3-8, 5-2, 5-7
- screen, 3-2
  - cleaning, 11-1
  - control keys, 3-2
- screen problems, 12-18
- security, 3-8, 7-1
- Security Management, 9-16
- serial connector, 2-2
- serial number, computer, A-1
- setup (computer), 10-3
- setup password, 7-9
- shipping computer, 11-3
- signal strength, 8-7
- sound, 9-3
- speaker jack, 2-4
- speakers, 9-4
  - built-in, 2-1
  - controlling volume, 9-5

- specifications, D-1
- startup options, 10-2
- stereo line-in jack, 9-2
- stereo speakers, 2-1, 9-4
- storing battery packs, 4-9
- support, Compaq, A-1
- Suspend
  - exiting, 5-6
  - initiating, 5-5
- suspend button, 2-6
- switch (power), 2-6
- switching displays with hotkeys, 3-7
- symbols used in guide, xiii
- system information, 10-5
- system warning beeps
  - adjusting, 3-7

## T

- telephone numbers worldwide, A-2
- temperatures, 11-2
- TEST, 10-4
- text stretch, 3-10
- three-to-two-prong plug adapter, 1-3, 4-5
- timeout, 5-8
- top components, 2-6
- traveling with computer, 11-2
- troubleshooting
  - audio problems, 12-2
  - battery/battery gauge problems, 12-4
  - compact disc/CD-ROM drive
    - problems, 12-6
  - diskette drive problems, 12-7
  - hard drive problems, 12-8
  - infrared problems, 12-9
  - keyboard/numeric keypad problems, 12-11
  - modem problems, 12-11
  - PC Card problems, 12-14
  - power problems, 12-17
  - screen problems, 12-18
  - USB problems, 12-19

turning off computer, 5-1  
twenty-five pin connector, 2-4  
types of PC Cards, 9-8  
typographical conventions, xiii

## U

Unimodem, 8-2  
USB port, 2-2  
USB problems, 12-19  
user password, 7-2, 7-6  
    deleting, 7-6

## V

View System Information (INSPECT),  
    10-5  
volume, 9-5

## W

weight saver, MultiBay, 6-3  
Windows, 5-3  
Windows 95, 1-7, 3-7, 5-2, 7-7, 7-13,  
    9-6, 9-10, 10-1, 10-8  
Windows NT, 1-7, 5-2, 7-7, 7-13, 9-10,  
    10-2, 10-8  
worldwide phone numbers, A-2

# DOCUMENTATION SURVEY

Thank you for choosing Compaq!

Please help us provide quality support information by completing and returning this postage-paid questionnaire.

1. Were you able to set up the computer using the setup poster?  
 Yes  No If not, at what point did you begin to have difficulty?  
\_\_\_\_\_

2. Was the online *Reference Guide* easy to find?  Yes  No  
Is it easy to use?  Yes  No If not, why?  
\_\_\_\_\_

3. What computer task(s) will you need the most help with?  
\_\_\_\_\_  
\_\_\_\_\_

4. If you need help with a computer task, where will you get it?  
\_\_\_\_\_  
\_\_\_\_\_

5. What kind of references do you prefer?  Online  Printed Why?  
\_\_\_\_\_  
\_\_\_\_\_

6. In addition to a printed *Reference Guide*, how else would you prefer to receive your information?

Rank 1 to 4 (1 is most preferred)

\_\_\_\_\_ Guide preinstalled on computer

\_\_\_\_\_ Guide on CD-ROM

\_\_\_\_\_ Guide on Compaq web site

\_\_\_\_\_ None of above

Additional Documentation Comments: \_\_\_\_\_

\_\_\_\_\_

\_\_\_\_\_

\_\_\_\_\_

Note: For comments not related to documentation, call  
1-800-345-1518 (U.S.) or 1-800-567-1616 (Canada).

Name \_\_\_\_\_

Occupation \_\_\_\_\_

Company \_\_\_\_\_ Phone No. \_\_\_\_\_

Street Address \_\_\_\_\_

City \_\_\_\_\_ State \_\_\_\_\_ Zip \_\_\_\_\_

Compaq Armada 7400 Family of Personal Computers