

# Notice

The information in this guide is subject to change without notice.

COMPAQ COMPUTER CORPORATION SHALL NOT BE LIABLE FOR TECHNICAL OR EDITORIAL ERRORS OR OMISSIONS CONTAINED HEREIN; NOR FOR INCIDENTAL OR CONSEQUENTIAL DAMAGES RESULTING FROM THE FURNISHING, PERFORMANCE, OR USE OF THIS MATERIAL.

This guide contains information protected by copyright. No part of this guide may be photocopied or reproduced in any form without prior written consent from Compaq Computer Corporation.

©1998 Compaq Computer Corporation. All rights reserved. Printed in Singapore.

Compaq and LTE are registered in the U.S. Patent and Trademark Office. Armada is a trademark of Compaq Computer Corporation.

Microsoft, MS-DOS, and Windows are registered trademarks of Microsoft Corporation.

The software described in this guide is furnished under a license agreement or nondisclosure agreement. The software may be used or copied only in accordance with the terms of the agreement.

Product names mentioned herein may be trademarks and/or registered trademarks of their respective companies.

## REFERENCE GUIDE

Compaq Armada 4200 Family of Personal Computers

First Edition (January 1998)

Part Number 290779-001

**Compaq Computer Corporation**

# CONTENTS

*preface*

## **BEFORE YOU BEGIN**

*chapter 1*

### **FINDING INFORMATION ABOUT YOUR COMPUTER**

Printed and Online References .....	1-1
Online Options Catalog .....	1-2
Ordering Backup Software .....	1-2

*chapter 2*

### **TAKING A LOOK AT THE COMPUTER**

Front and Left Side Components .....	2-2
Front and Right Side Components.....	2-3
Keyboard Components .....	2-4
Status Panel Lights .....	2-6
Rear Components.....	2-7
Bottom Components .....	2-9
Versatile Handle .....	2-10
External Diskette Drive Bay .....	2-10

*chapter 3*

### **USING KEYBOARD SHORTCUTS**

User-Programmable Keys .....	3-2
Assigning Programmable Keys .....	3-2
Unassigning User-Programmable Keys .....	3-3
Adding Schemes .....	3-4
Removing Schemes .....	3-4
Key Assignments on the Taskbar .....	3-4
Using the Hotkeys .....	3-5
Using Special Function Keys.....	3-7
Using the Numeric Keypad.....	3-8

*chapter 4*

**WORKING WITH POINTING DEVICES**

Mouse Utility .....4-2  
Touchpad Components .....4-3  
Trackball Components .....4-4  
Removing a Pointing Device .....4-5  
Installing a Pointing Device.....4-7

*chapter 5*

**MANAGING POWER**

Power Button .....5-2  
    Power Choices .....5-3  
Suspend Button .....5-3  
    How Suspend Is Initiated .....5-4  
    Initiating Suspend .....5-4  
    Exiting Suspend .....5-5  
Hibernation .....5-6  
    Initiating Hibernation .....5-6  
    Exiting Hibernation .....5-7  
AC Power .....5-7  
Battery Power.....5-9  
    Battery Charging/Discharging .....5-9  
    Comparing Battery Types .....5-10  
    Resolving a Low-Battery Condition .....5-11  
    Extending Battery Pack Operating Time .....5-12  
    Charging the Battery Pack(s).....5-13  
    Recycling Used Batteries in North America .....5-14  
    Recycling Used Batteries in Europe .....5-14  
Power Properties Utility .....5-15  
    Battery Status Tab.....5-16  
    Setting Battery Conservation Levels .....5-17  
    Setting a Timeout.....5-18  
    Turning Hibernation On or Off.....5-19  
    The Battery Gauge Pop-up.....5-20

*chapter 6*

**USING THE HANDLE**

Handle Functions .....6-1  
Attaching the Handle .....6-2  
Detaching the Handle.....6-3

Handle Tilt Feature .....	6-5
Removing/Inserting the Handle Battery .....	6-5

*chapter 7*

**USING THE DUALBAY**

Inserting/Removing the Diskette Drive .....	7-2
Inserting a Diskette .....	7-4
Removing a Diskette.....	7-4
Removing/Inserting the Modular Battery .....	7-5

*chapter 8*

**USING THE EXTERNAL DISKETTE DRIVE BAY**

Inserting the Diskette Drive into the External Diskette Drive Bay .....	8-2
Removing the Diskette Drive from the External Diskette Drive Bay .....	8-3

*chapter 9*

**ENJOYING COMPAQ AUDIO**

Identifying Built-In Audio Components.....	9-2
External Audio Jacks .....	9-3
Stereo Line-In Jack .....	9-4
Internal Microphone .....	9-5
Volume Control .....	9-6
Using the Stereo Speakers .....	9-7

*chapter 10*

**CONNECTING EXTERNAL DEVICES**

Configuration Utilities.....	10-2
Device Manager Utility .....	10-2
Add New Hardware Utility .....	10-2
Using PC Cards .....	10-3
Understanding Plug and Play .....	10-4
Managing PC Card Power .....	10-4
Inserting a PC Card .....	10-5
Removing a PC Card .....	10-6
PC Card Software .....	10-7
USB CardBus PC Card.....	10-7
Connecting Video .....	10-7
Using the Video Utility .....	10-7

Connecting a TV or VCR .....	10-8
Displaying Pictures .....	10-9
Connecting Infrared Equipment.....	10-10

*chapter 11*

**ADDING SOFTWARE AND UPGRADES**

Installing Software .....	11-2
Operating System Support .....	11-2
Upgrading Memory .....	11-3
Memory Upgrade Options .....	11-3
Checking Current Memory .....	11-3
Adding Memory .....	11-4
Upgrading the Hard Drive.....	11-5

*chapter 12*

**SETTING SECURITY FEATURES**

Setting Passwords Properties .....	12-2
Power-On Password .....	12-2
Establishing a Power-On Password .....	12-2
Entering the Power-On Password .....	12-3
Deleting/Changing Power-On Password .....	12-3
If You Forget Your Power-On Password.....	12-3
Establishing a Setup Password.....	12-4
Deleting/Changing a Setup Password.....	12-5
Identifying Quick Controls .....	12-5
Initiating Quick Controls .....	12-6
Using a Cable Lock.....	12-7

*chapter 13*

**CARING FOR THE COMPUTER**

Routine Care .....	13-2
Travel Guidelines.....	13-3
Shipping Guidelines.....	13-4

*chapter 14*

**COMPUTER SETUP AND DIAGNOSTICS**

Setup and Diagnostics Utilities.....	14-2
Accessing Computer Setup .....	14-2
Accessing Diagnostics Utilities .....	14-3
Diagnostics for Windows.....	14-3

Compaq Diagnostics.....	14-4
Running Computer Checkup (TEST) .....	14-4
Running the View System Information (Inspect Utility) .....	14-6

*chapter 15*

**TROUBLESHOOTING**

Checklist.....	15-1
Interpreting Messages on the Screen .....	15-2
Solving Minor Problems.....	15-3
Solving Battery Problems.....	15-3
Solving Diskette/Diskette Drive Problems .....	15-6
Solving Hard Drive Problems.....	15-7
Solving Hardware Installation Problems .....	15-8
Solving Keyboard and Embedded Numeric Keypad Problems .....	15-9
Solving Memory Problems .....	15-10
Running the Monitor Self-Test.....	15-10
Solving PC Card Problems .....	15-11
Solving Power Problems .....	15-13
Solving Printer Problems.....	15-14
Solving Display Screen Problems .....	15-15
Solving Software Application Problems .....	15-17
Solving Sound Problems .....	15-17
Solving Pointing Device Problems.....	15-18
Cleaning the Trackball .....	15-20
Cleaning Inside the Trackball Assembly .....	15-21
Servicing the Computer.....	15-22
Preparing for a Call to Customer Support .....	15-23

*chapter 16*

**INTELLIGENT MANAGEABILITY**

Access to Intelligent Manageability .....	16-1
Features and Benefits.....	16-1
Asset Management.....	16-2
Fault Management .....	16-2
Security Management .....	16-3

<i>appendix A</i>	
<b>WORLDWIDE TELEPHONE NUMBERS</b> .....	A-1
<i>appendix B</i>	
<b>POST ERROR MESSAGES</b> .....	B-1
<i>appendix C</i>	
<b>CONNECTOR PIN ASSIGNMENTS</b> .....	C-1
<i>appendix D</i>	
<b>POWER CORD SET REQUIREMENTS</b>	
General Requirements .....	D-1
Country-Specific Requirements .....	D-2
<i>appendix E</i>	
<b>ELECTROSTATIC DISCHARGE</b>	
Preventing Electrostatic Discharge .....	E-1
Grounding Methods .....	E-1
<i>appendix F</i>	
<b>AGENCY REGULATORY NOTICES</b>	
Agency Regulatory Identification Numbers .....	F-1
Battery Notice .....	F-4
Energy Star Compliance .....	F-5
<i>appendix G</i>	
<b>SPECIFICATIONS</b> .....	G-1
<i>rd appa.doc</i>	
<b>INDEX</b> .....	I-1

## BEFORE YOU BEGIN

Some or all of the following format conventions are used in this guide to distinguish elements of text:

- Names of keys are shown in bold type as they appear on the keyboard, for example, **Ctrl**, **Backspace**, **Tab**.
- Keys that you should press at the same time are represented by the key names and the plus (+) symbol, for example, **Ctrl+Alt+Delete**.
- Commands are presented in lowercase, bold type as shown here: **install** or **a:\install**.
- An arrow symbol is used to separate icons or menu options that you should select in succession, for example, click the Start button → Settings → Control Panel.
- When you need to type information without pressing the **Enter** key, you are directed to “type” the information.
- When you need to type information *and* press the **Enter** key, you are directed to “enter” the information.

**NOTE:** Text set off in this manner presents commentary, sidelights, or interesting points of information.

**IMPORTANT:** Text set off in this manner presents clarifying information or specific instructions.



**WARNING:** Text set off in this manner indicates that failure to follow directions could result in bodily harm or loss of life.

---



**CAUTION:** Text set off in this manner indicates that failure to follow directions could result in damage to equipment or loss of information.

---



# chapter 1

## FINDING INFORMATION ABOUT YOUR COMPUTER

In this chapter you will learn about the references that come with your computer and where to find them.

References are provided for you in two forms:

- As printed materials
- As online information accessible from the computer screen

**NOTE:** The references that come with the computer vary by model.

### Printed and Online References

The following printed references come with your computer:

- A quick setup poster
- *Reference Guide*
- Microsoft Windows Operating System Guide
- *Safety & Comfort Guide*
- Kensington Security Card
- Warranty and service information

The following Compaq online references are preinstalled on your computer:

- *Compaq Reference Guide*
- *Safety & Comfort Guide*
- *Compaq Dictionary*
- Options Catalog

The online references installed on the computer include the user's guides, application help, software utilities help, and customer support information. Many are accessible from the Compaq Information Center folder on the Start menu. Others can be accessed from the application or utility screens.



**CAUTION:** Most online references are available only through the Windows interface. If you delete Windows, those references will also be deleted. Therefore, Compaq recommends that you not delete Windows software.

---

## Online Options Catalog

To learn more about the many Compaq options designed to enhance your computer, go to the Compaq Information Center on the Start menu. Click the Options Catalog to see an illustration and description of the many options for your computer. Use the part number included to order from your Compaq dealer, reseller, or service provider.

## Ordering Backup Software

Compaq recommends that you create a backup of the software preinstalled on the computer. Or, for an additional cost, you can order a backup CD or diskettes from Compaq for all software preinstalled on this computer.

To order backup diskettes or CDs, refer to the "Worldwide Telephone Numbers" listed in Appendix A. If an order form is included with your computer, complete the form and return it. Or call one of the numbers listed on the order form.

**IMPORTANT:** Before calling Compaq to place your order, find the serial number on the bottom of your computer. This number is necessary for all backup diskette or CD purchases.

# chapter 2

## TAKING A LOOK AT THE COMPUTER

Your computer is equipped with many features, including hotkeys, programmable keys, light indicators, and connectors. This chapter familiarizes you with the components on the computer and how to use them.

External devices such as a printer, portable expansion unit, monitor, keyboard, or mouse can be connected to your computer to enhance its functionality. See Chapter 10, “Connecting External Devices,” for more details.

Illustrations and tables on the following pages identify the computer’s primary components, including:

- Front and left side components
- Front and right side components
- Keyboard components
- Status panel lights
- Rear components
- Bottom components
- Versatile handle
- External Diskette Drive Bay

# Front and Left Side Components

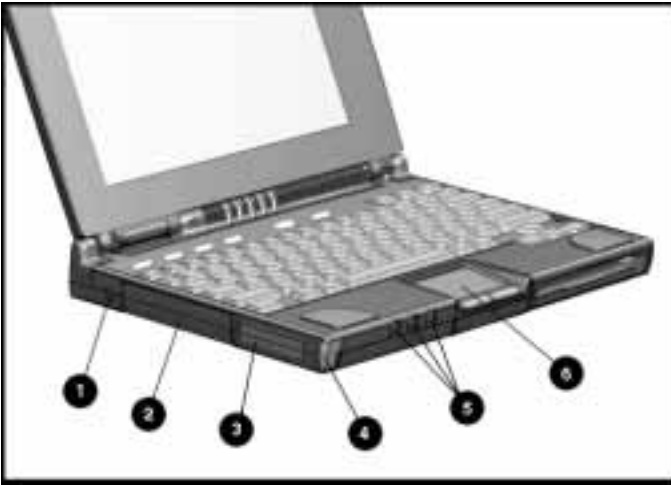

*Front and Left Side Components*

---

## Front and Left Side of the Computer

---

Ref.	Component	Function
1	Cable lock provision	Protects your computer from theft.
2	Hard drive	Drive inside your computer that stores data.
3	PC Card slots	Accept one Type III, or two Type II, or two Type I PC Cards.
4	PC Card eject buttons	Release PC Cards.
5	Audio connectors	Allow you to connect a microphone, stereo, or headphone to your computer. (See Chapter 9, "Enjoying Compaq Audio," for details.)

---

# Front and Right Side Components



*Front and Right Side Components*

---

## Front and Right Side of the Computer

---

Ref.	Component	Function
1	DualBay	Accepts an internal diskette drive (3.5-inch diskettes) or modular battery pack.
2	DualBay eject button	Ejects the diskette drive or modular battery pack.
3	AC power connector	Connects the AC Adapter to the computer. Use the power cord extension included with your computer when you need to reach a distant electrical outlet to connect the AC Adapter.

---

# Keyboard Components

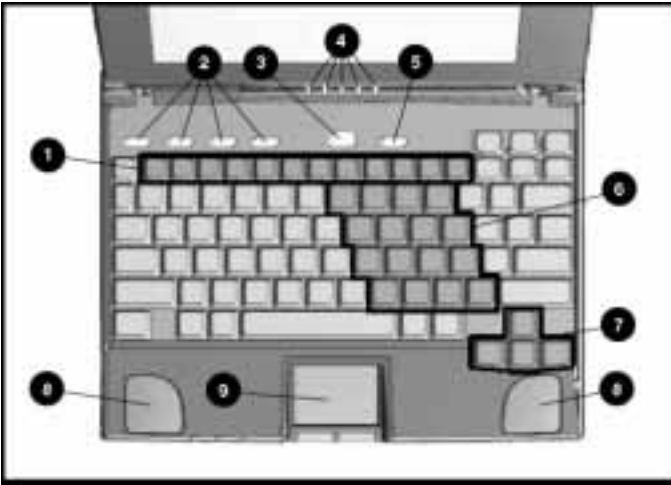

Keyboard

---

## Keyboard Components

---

Ref	Component	Function
1	Function keys <b>Fn+F1 - Fn+F10</b>	Used for specific functions in applications and operating systems.
2	User-programmable keys	Assign and launch applications or documents quickly and emulate Windows and Application Logo Keys.
3	Suspend button	When pressed once with the computer on, initiates Suspend; when pressed the second time, exits Suspend; when pressed simultaneously with <b>Fn</b> , initiates Hibernation.
4	Status panel lights	Display computer status indicators.
5	Power button	When pressed the first time, turns on the computer. (See chapter 5, "Managing Power," for details.) <b>NOTE:</b> To turn off the computer, use Shut Down from the Windows Start menu. In case of a system lockup, when the mouse doesn't work and <b>Ctrl+Alt+Del</b> is not recognized by the unit, press <b>Power</b> or <b>Ctrl+Power</b> to turn off the unit.
6	Embedded numeric keypad	Allows two operating modes, numeric (if <b>Fn+NumLk</b> is on) and edit (if <b>Fn+NumLk</b> is off).



## Keyboard Components *Continued*

Ref	Component	Function
.		
7	Arrow keys	Allow cursor to move up, down, right, left.
8	Stereo speakers	Produce high-quality stereo sound.
9	Pointing device	The touchpad moves the pointer around the screen and functions as a portable mouse.



# Status Panel Lights

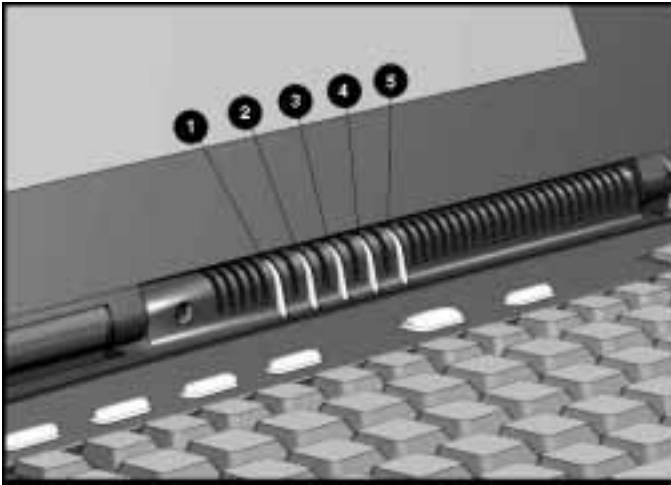

*Status Panel Lights*

---

## Status Panel Lights

---

Ref.	Indicator	Function
1	Power/ Suspend	Turns on (solid) when power to the computer is turned on; blinks in Suspend mode; turns off when computer is in Hibernation or powered off.
2	Battery charge	Turns on (solid) when computer is turned on and when battery is fast charging. If a low-battery point is reached, light will flash 6 times and you'll hear a beep. If a critical low-battery state is reached, you'll hear a beep and the light will flash constantly. If you do not attach an AC Adapter within 20 seconds of this warning, the unit will initiate Hibernation (unless Hibernation has been disabled).
3	Caps Lock	Turns on when <b>Caps Lock</b> function is on.
4	Scroll Lock	Turns on when the <b>Scroll Lock</b> function is on.
5	Num Lock	Turns on when the <b>NumLk</b> function is on.

---

# Rear Components

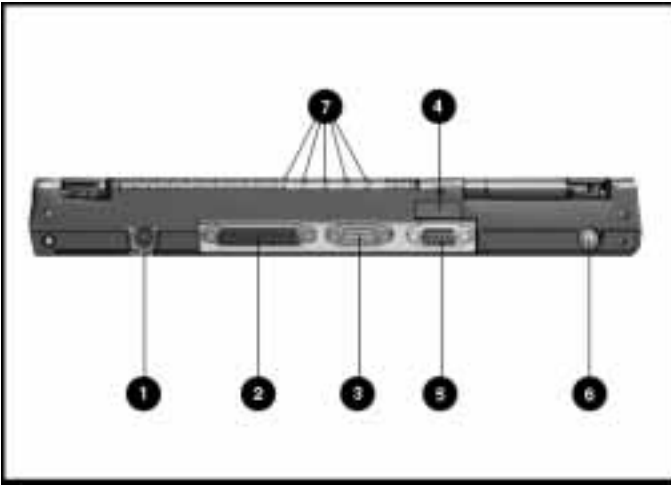

Rear Components

---

## Rear of the Computer

---

Ref	Component	Function
1	Keyboard/mouse connector	Connects an external keyboard, mouse, or other compatible PS/2 pointing device.
2	Parallel connector	Connects optional parallel devices, such as a printer. Also connects the External Diskette Drive Bay.
3	Serial connector	Connects optional serial devices, such as a mouse.
4	Infrared lens (IrDA compliant)	Sets up wireless data transfer for printing.
5	External monitor connector	Connects external monitor to computer

*Continued*

## Rear Components Continued

Ref	Component	Function
6	NTSC/PAL Video	<p>Connects the computer to TV, VCR, camcorder, or laser disc, using the NTSC (U.S.) and PAL (European) formats. You can use the NTSC/PAL cable included with your computer to make video connections.</p> <p><b>IMPORTANT:</b> See “Connecting Video” in Chapter 10, “Connecting External Devices,” for information regarding the U.S./European video connectors.</p>
7	Status panel indicator lights	Status panel lights remain in view when the computer is closed.

# Bottom Components

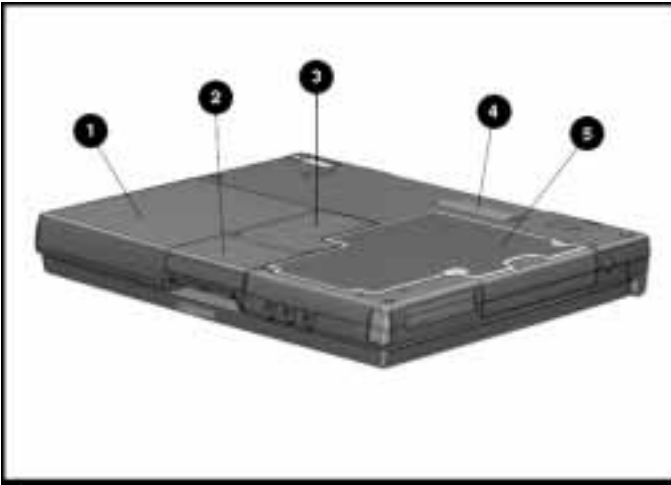

*Bottom Components*

---

## Bottom of the Computer

---

Ref	Component	Function
1	DualBay	Accepts an internal diskette drive (3.5-inch diskettes) or modular battery pack.
2	Pointing device	The touchpad moves the pointer around the screen; functions as a mouse.
3	Memory compartment	Stores the memory expansion boards.
4	Expansion slot	120-pin connector interface for the Mobile CD Expansion Unit (MCD) or convenience base.
5	Hard drive compartment	Contains the hard drive.

## Versatile Handle

A multifunctional handle with a Lithium Ion battery pack inside provides more portable power by adding a second battery pack. In addition, the handle moves to three convenient positions:

- Creates a comfortable tilt for working at the keyboard. Fold the handle back and under the computer.
- Provides a cover for the rear connectors. Place the handle in a straight position while the computer is lying flat.
- Enables you to carry the computer like a briefcase.

**NOTE:** For more information about the handle, see Chapter 6, “Using the Handle.”



*Versatile Handle*

## External Diskette Drive Bay

When you want to operate on battery power but need to use the diskette drive, install the drive in the external drive bay. It includes a parallel cable that connects to the parallel port on the rear of the computer.

See Chapter 8, “Using the External Diskette Drive Bay,” for details on how to use this feature.

# chapter 3

## USING KEYBOARD SHORTCUTS

Keyboard shortcuts help you customize the keyboard. You can use designated keys to change and select computer settings, such as speaker volume, battery conservation, and popup windows. This chapter familiarizes you with the following keyboard and shortcut features:

- User-programmable keys
- Hotkeys
- Special function keys
- Embedded numeric keypad

# User-Programmable Keys

The four user-programmable keys ❶ at the top of the keyboard allow you to quickly open an application on your computer, bring up a document, or emulate one of the Microsoft Windows and Application Logo Keys.

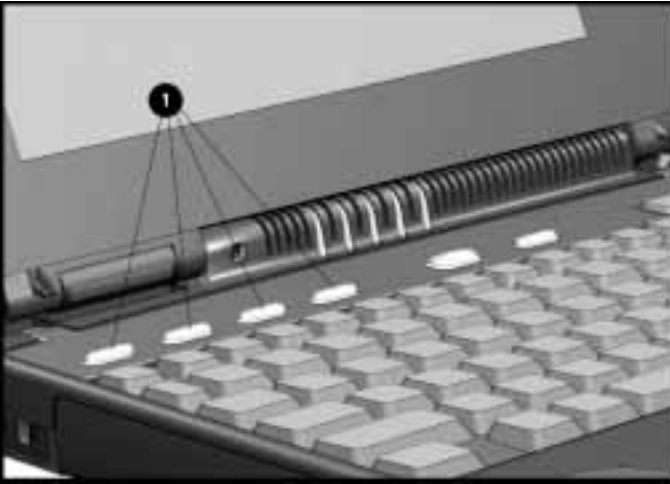

*User Programmable Keys*

By assigning the programmed keys to schemes, you can create multiple sets of key assignments that will allow you to open almost any application or document on your computer.

## Assigning Programmable Keys

To assign user-programmable keys, follow these steps:

1. Access the Programmable Keys utility in the Control Panel on the Windows Start button.
2. Select the programmable key you want to assign or reassign in the current scheme by clicking the appropriate radio button in the Key assignments group box.

**NOTE:** To assign keys in other than the current scheme, place a check in the Show advanced options checkbox and look in the Scheme box to see the scheme you are currently using. You can create a new scheme or add/change key assignments in the current scheme. If you have never created a scheme, the Default scheme will be in effect.

3. Click the Assign button. A dialog box appears showing a list of programs or documents from the Programs menu.

**NOTE:** To access a larger number of programs, click the Show advanced options checkbox. This changes the Assign button to the Browse button. By clicking the Browse button, you can access all applications on your computer. To emulate one of the Microsoft Windows and Application Logo Keys, select the appropriate file from the WINDOWS\CPQWIN directory.

4. Highlight the desired application and click OK. The icon and program name you selected will appear beside the programmable key's radio button.
5. Click OK to exit this utility. When you push the programmable key you just assigned, your application or document will appear on screen.

## Unassigning User-Programmable Keys

To remove a programmable key assignment, follow these steps:

1. Access the Programmable Keys utility in the Control Panel.
2. Select the programmable key you wish to unassign by clicking the appropriate radio button in the Key assignments group box.

**NOTE:** To assign keys in other than the current scheme, place a check in the Show advanced options checkbox and look in the Scheme box to see the scheme you are currently using. You can create a new scheme or add/change key assignments in the current scheme. If you have never created a scheme, the Default scheme will be in effect.

3. Click the Assign button, then select Unassigned from the list. The icon and program name previously assigned to the key will be removed.

**NOTE:** When the Show advanced options box is checked, you can unassign a programmable key by clicking the Browse button and selecting "Unassigned" in the WINDOWS\CPQWIN directory.

4. Click OK to exit the utility.



## Adding Schemes

A scheme is a programmable key assignment that you define and is unique to your Windows user profile.

To add a new scheme, do the following:

1. Access the Programmable Keys utility in the Control Panel.
2. Click the Show advanced options checkbox.
3. Click the Add button.
4. Type the name of your new scheme in the popup dialog box that appears.
5. Make your programmable key assignments.
6. When the assignments have been made, click OK to exit the utility.

## Removing Schemes

To remove a new scheme, do the following:

1. Access the Programmable Keys utility in the Control Panel.
2. Place a check in the Show advanced options checkbox if one is not already there.
3. Be sure the scheme in the Scheme box is the one you want to delete. To view a different scheme, select a scheme from the drop-down list.

**NOTE:** The Default scheme is not removable.

4. Click the Remove button.
5. Click OK to exit the utility.

## Key Assignments on the Taskbar

One convenient way to see your user-programmable key assignments is to view them in a popup window that you activate from an icon in the system tray (taskbar). To enable the icon:

1. Access the Programmable Keys utility in the Control Panel.
2. Place a check in the Show key assignments in the System Tray checkbox.
3. Click OK to exit the utility.

An icon appears in the taskbar. To view the popup window, click the icon.

**NOTE:** The icon remains in the system tray (taskbar) until you disable it by unchecking Show Key Assignments in the System Tray checkbox.

# Using the Hotkeys

The hotkey combinations (**Fn+F1 - F10**) allow you to use the arrow keys to quickly adjust computer settings using the **Fn** plus hotkeys **F1** through **F10**. To use the arrow keys to adjust settings, hold down the hotkeys while using the up, down, right, or left arrow keys.

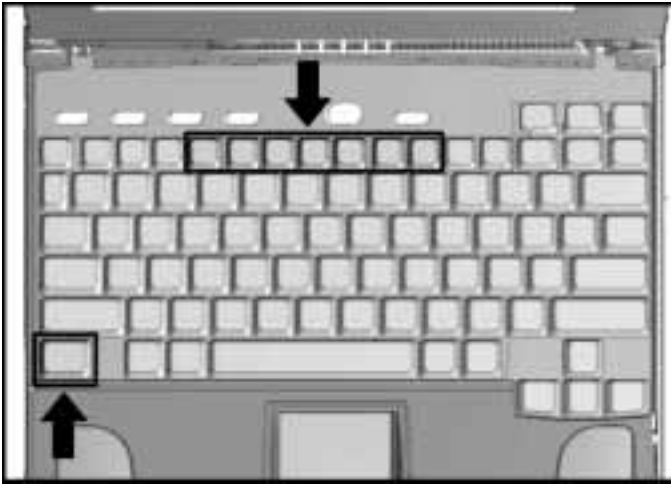

*Hotkeys*

**NOTE:** When you press most hotkeys the second time, the keys are toggled off. An exception is the **Fn+F6** QuickLock/QuickBlank hotkeys, which require the power-on password to disable.

---

## Hotkey Assignments and Functions

---

Feature	Hotkeys	Function
Popup icon location	<b>Fn+F1</b>	Adjusts the popup icon location. Use the arrow keys to move the icon up or down, left or right.
BIOS version	<b>Fn+F2</b>	Displays the BIOS version number.
Switches displays	<b>Fn+F4</b>	Toggles between computer display, external monitor display, both displays at the same time, or TV screen.
Speaker volume	<b>Fn+F5</b>	Adjusts speaker volume up or down.

*Continued*

## Hotkey Functions and Assignments *Continued*

Feature	Hotkeys	Function
Quick Lock/ QuickBank	Fn+F6	Initiates QuickLock, which disables the keyboard and mouse, and QuickBlank, which clears the screen. Enter power-on password to disable QuickLock and QuickBlank and reactivate keyboard, mouse, and screen.
Battery Conservation	Fn+F7	Displays the battery conservation settings in a popup window. Use the left and right arrow keys to select a different setting. <b>NOTE:</b> See Chapter 5, "Managing Power," for more information.
Battery Gauge	Fn+F8	Press the right or down arrow keys to select the next battery to be displayed. If a battery is not present, its selection will be skipped. Pressing left or up arrow keys will select the previous battery. If the user does not depress any arrow keys for 5-7 seconds, the popup will display the average remaining capacity of all installed batteries. <b>NOTE:</b> See Chapter 5, "Managing Power," for more information.
Contrast Control	Fn+F9	Adjusts the display contrast. Press the right arrow key to increase contrast; press the left arrow key to decrease contrast. <b>NOTE:</b> On models with active matrix display, contrast control is not applicable.
Brightness Control	Fn+F10	Adjusts the display brightness. Press the right arrow key to increase light intensity; press the left arrow key to decrease light intensity.
Hibernation	Fn+ suspend	Initiates Hibernation.
Num Lock	Fn+Num Lk	Enables and disables the embedded numeric keypad.

# Using Special Function Keys

Some keys on the keyboard provide special functions, depending on the application you are using. These keys are described in the following table:

Special Function Keys	
Key	Function
Alt	Application dependent, used in combination with another key for a specific function. Refer to the documentation for the application you are using.
Backspace	Moves the cursor left and deletes characters as it moves left.
Caps Lock	When the <b>CapsLock</b> indicator is on, all letters typed are capitalized.
Ctrl	Application dependent; used in combination with other keys for specific functions. Refer to the documentation for the application software you are using.
Esc	Often assigned a specific task by the application. Frequently used as an exit key.
F1 – F12	Used for a specific function in applications and operating systems. Check the documentation for the application software you are using.
NumLk	Activate this function by pressing <b>Fn+NumLk</b> . When the <b>NumLk</b> indicator light is on, the embedded numeric keypad is activated. Use this toggle key feature to enable and disable the numeric keypad.
Pause	Temporarily suspends screen scrolling. Activate this function by pressing <b>Fn+Pause</b> . Deactivate Pause by pressing any key.
PrtSc	Prints the information on the screen line-by-line to a local printer. Using this key will print only the information on the screen. Activate this function by pressing <b>Fn+PrtSc</b> .
Scroll	When the <b>Scroll Lock</b> indicator light is on, prevents the screen from scrolling. Access this function by pressing <b>Fn+Scroll</b> .

*Continued*

---

Key	Function
Ctrl+Alt+Delete	Restarts the system after the computer has been turned on and is locked up while in MS-DOS mode. <b>NOTE:</b> Shut Down on the Windows Start menu is the recommended way to restart the computer while in Windows. Also stops the restoration of information when the computer exits Hibernation.
Fn + suspend	Initiates Hibernation.
Ctrl+Power	Resets the system in case of a system lockup, when the mouse doesn't work and Ctrl+Alt+Del is not recognized by the unit.

---

## Using the Numeric Keypad

The embedded numeric keypad is a section of the keyboard that converts to a numeric keypad when the **NumLk** function is activated. This is done by pressing **Fn+NumLk**. Use this toggle key function to enable and disable the embedded numeric keypad.

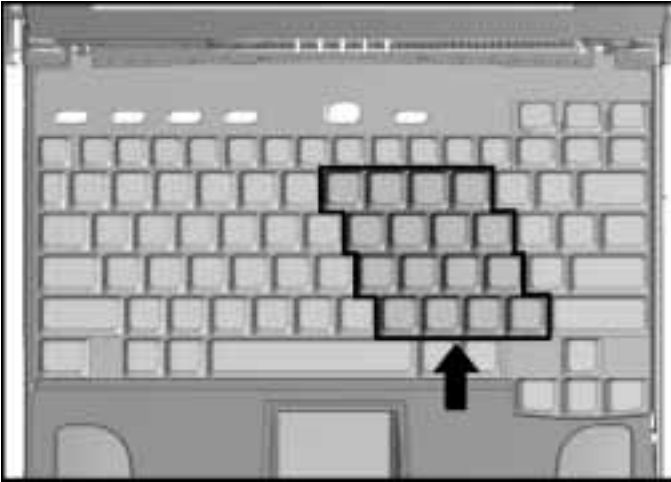

*Embedded Numeric Keypad*

# chapter 4

## WORKING WITH POINTING DEVICES

The pointing device on your computer is a versatile feature that eliminates the need to carry a mouse when traveling. It moves the cursor around the screen and can be used with either hand.

This computer can use either a modular touchpad or trackball pointing device. Your computer comes with a touchpad.

This chapter familiarizes you with trackball and touchpad features, including:

- Accessing the mouse utility
- Identifying touchpad components
- Identifying trackball components
- Removing the pointing device
- Installing a pointing device

# Mouse Utility

Button functions and other touchpad/trackball features can be customized using the Mouse utility located in the Control Panel on the Windows Start menu. To access this utility using the touchpad or trackball, follow these steps.



## **Using the trackball:**

1. Roll the ball down to move the cursor to Start. With the top button, click Start.
2. Roll the ball up to highlight Settings, then Control Panel.
3. Roll the ball to the Mouse icon. Press the top button twice to double click. Click the General tab, then Options, and follow the instructions on the screen.

## **Using the touchpad:**

1. Move your finger across the active surface of the touchpad to move the cursor to Start. With the left button, click Start or tap the touchpad on the Start button.
2. Move your finger up to highlight Settings, then Control Panel.
3. Move your finger across the touchpad to the Mouse icon on the Control Panel. Press the left button twice or double tap the touchpad. Click with the left button (or tap) on General tab, then Options, and follow the instructions on the screen.

# Touchpad Components

The modular touchpad features a flat active pad surface , and your fingertip acts as the pointing device. The left button  functions like the left mouse button. The right button  works like the right mouse button.

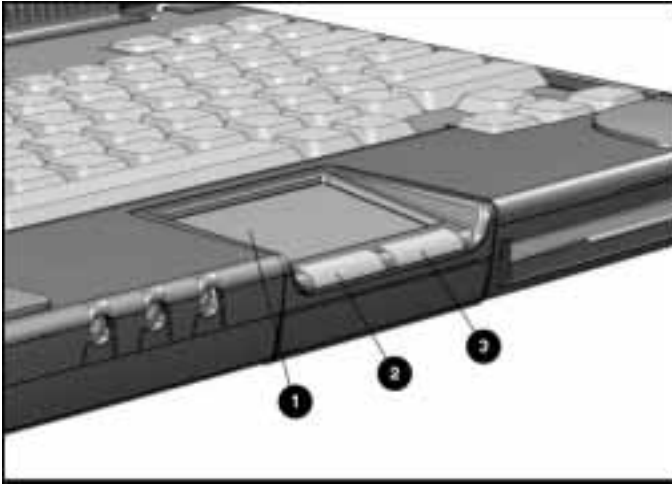

*Touchpad Components*



For more information on customizing touchpad settings, refer to the Help in the mouse utility.

To clean the touchpad, spray a lint-free cloth with a non-abrasive cleaner and wipe the surface of the touchpad. To remove a more serious stain or mark, use a damp (not wet) cloth and a small amount of dishwashing detergent.

**NOTE:** To prevent damage to the electrical system, do not spray cleaner directly on the touchpad or keyboard.



# Trackball Components

The modular trackball is similar to the touchpad but uses a ball to control the cursor. The top button  functions as a left mouse button, and the bottom button  acts as a right mouse button. The ball  rolled with the thumb, controls the cursor and can be used with either hand.

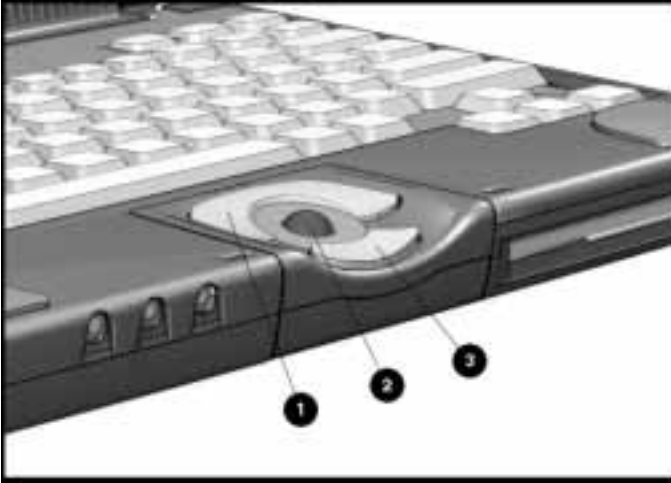

*Modular Trackball Components*

See Chapter 15, “Troubleshooting,” for information on cleaning the trackball. Refer to the Mouse utility in the Control Panel to configure button settings and double-click speed, to customize the pointer and control pointer motion.

# Removing a Pointing Device

If you prefer a different pointing device, you can replace the pointing device easily. Before removing the pointing device from the computer, remove the device in the DualBay. Follow these steps to remove a device from the DualBay”

1. Initiate Suspend.

**NOTE:** If the battery in the DualBay is the only power source, connect external power.



2. Press the DualBay eject button  on the right side of the computer.

**NOTE:** The DualBay can accommodate either a modular battery pack or a diskette drive.

3. Pull the DualBay device out of the DualBay .



*Removing a DualBay Device (Diskette Drive)*

4. Press in the metal retaining clip  located in the wall between the DualBay and the pointing device bay, to release the pointing device. Pull the pointing device  and remove it.



*Removing the Pointing Device (Touchpad)*

# Installing a Pointing Device

1. With the computer in Suspend and the DualBay empty, align the slots in the sides of the pointing device with the guide rails in the pointing device bay.
2. Slide the pointing device forward into the bay until it snaps into place.



*Installing the Pointing Device (Trackball)*

3. Replace the DualBay device.
4. Press the suspend button again to exit Suspend, and resume your work.

# chapter 5



## MANAGING POWER

This computer has convenient features that allow you to manage power consumption and maximize battery operating time. The Power Properties icon in the Control Panel includes the power settings for your computer.

This chapter describes the following power management features:

- Power button
- Suspend button
- Hibernation
- AC power
- Battery power
- Power Properties utility

# Power Button

Press the power button  once to turn on the computer. When the power/suspend light  turns on, the computer is on. To turn off or restart the computer while working in Windows, click Shut Down on the Windows Start menu and follow the directions on the screen.

If you are using a non-Windows application or experience a system lockup in Windows, press **Power** to turn off the computer. If system lockup persists, press **Ctrl+Power** to turn off the computer. If system lockup persists, press **Ctrl+Power** to turn off the computer. When the power/suspend light goes off, the computer is off.

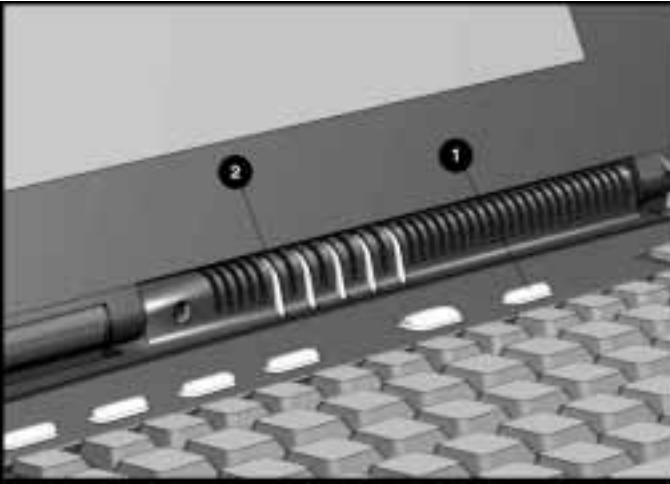

*Power Button and Power/Suspend Indicator Light*

## Power Choices

To decide when to turn off the computer or initiate Suspend, consider:

- If you use the computer frequently and want “instant-on” convenience, *you do not have to turn off the computer*. Simply initiate Suspend when you’re not using it.
- If external power is not connected, the batteries continue to drain while the computer is in Suspend, but at a much slower rate. If you want to charge the batteries while you’re not using the computer, connect to external power. The battery packs charge whether the computer is on or off. But they charge faster when the computer is off.
- If you plan to store the computer for six months or more, turn off the computer and remove the battery packs. This reduces a battery’s discharge rate and extends its operating life.

## Suspend Button



When you finish working, or if you want to pause in the middle of your applications, initiate Suspend.

Suspend has the following benefits:

- This feature puts the computer to sleep, uses very little power, and saves your place in your applications.
- During Suspend, most of the major components (hard drive, processor, and display) shut down.

**NOTE:** The computer can be left in Suspend up to 500 hours with a fully charged lithium ion battery pack, or up to 300 hours with a fully charged nickel metal hydride battery pack.

## How Suspend Is Initiated

- Suspend is initiated in one of three ways:
- Manually, at any time, by pressing the suspend button  once.  
The power/suspend indicator light  will blink slowly.

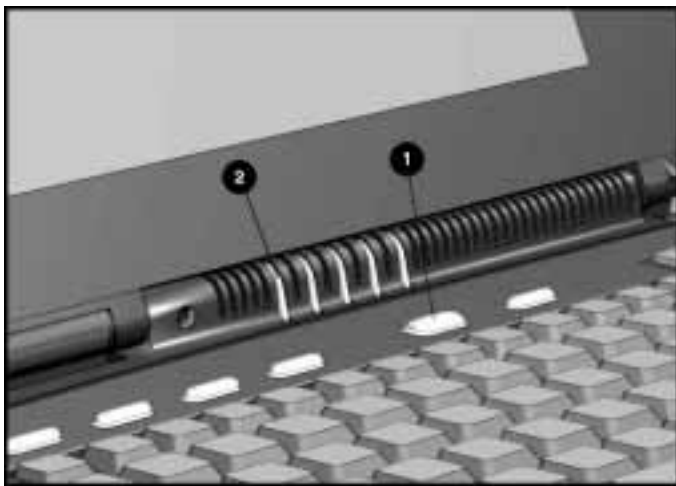

*Suspend Button and Power/Suspend Indicator Light*

- Automatically, when a predefined timeout has been reached. You can set the Suspend timeout period in Power Properties. Or refer to “Setting a Timeout” in this chapter.
- Manually, by clicking suspend from the Windows Start menu.

## Initiating Suspend

When Suspend is initiated, the following occurs:

- The computer beeps twice.  
**NOTE:** If speakers are turned off, beeps are not audible.
- The screen blanks.
- The power/suspend indicator light blinks.



## Exiting Suspend

Exit suspend by pressing the suspend button once. When you exit Suspend, the following occurs:

- The computer beeps twice.
- The power/suspend indicator turns on (continuous).
- The “instant-on” feature lets you pick up your work right where you left off. No information is lost.

**IMPORTANT:** The computer will not exit Suspend if the battery is low and external power is not connected. In this case, you must find a new power source for the computer. When a new power source is connected, press the suspend button once to return your information to the screen.

If the computer is in Suspend, and a low-battery condition occurs, the computer automatically initiates Hibernation (unless Hibernation has been disabled), saves your information to the hard disk, and turns off the computer. When you install a fully charged battery or connect to an external power source, your information returns to the screen at the point where Suspend was initiated. No information is lost.

# Hibernation

Hibernation is a safeguard condition during which all information in system memory is saved to the hard drive and power to the computer is turned off. When you resume work, your information is returned to the screen exactly where you left off. No information is lost.

Hibernation has the following benefits:

- Since the computer is turned off and there is no drain on battery packs, your computer can stay in Hibernation for an unlimited time.
- You can manually save your place in any application or when making a presentation.
- Information is automatically saved when the computer reaches a critical low-battery condition (as long as Hibernation has not been turned off).

## Initiating Hibernation

To initiate Hibernation:

- Press **Fn+ suspend** to initiate Hibernation manually. Hibernation marks your place in your applications *and turns power off completely to your computer.*
- System-initiated Hibernation occurs when the computer reaches a critical low-battery condition. To protect against loss of information, the computer automatically saves all information in system memory to the hard drive and then turns off. Press the power button once to resume work.

**NOTE:** Batteries that have not been fully charged may not have enough power to support a system-initiated Hibernation at critical low battery.

## Exiting Hibernation

To resume work after Hibernation is initiated, do the following:

1. While the computer is still in Hibernation, install a fully charged battery pack or connect to an external power source, if installed batteries aren't sufficiently charged.
2. Turn on the computer by pressing the power button once. The computer exits Hibernation. Information saved to the hard drive returns to the screen at the point where Hibernation was initiated.

**NOTE:** To stop the restoration of information, press **Ctrl+Alt+Delete**.

## AC Power





**CAUTION:** Ensure that the electrical outlet you plug the power cord into is easily accessible to you at all times. When you want to disconnect power from the computer, unplug the power cord from the electrical outlet.



**WARNING:** To reduce the risk of electric shock or damage to your equipment, do not disable the power cord grounding feature. This computer is designed to be connected to a grounded (earthed) outlet that is easily accessible. The grounding plug is an important safety feature.

---

You can connect your computer to an electrical outlet with the AC Adapter that came with your computer. To connect the AC Adapter:

1. Connect the small end  of the AC power cord into the AC Adapter.
2. Connect the AC Adapter to the AC power connector .

**NOTE:** If the computer is attached to a Mobile CD Expansion Unit (MCD), connect the AC Adapter to the MCD. If the computer (either alone or with the MCD) is docked in the convenience base, connect the AC Adapter to the convenience base.

3. Plug the power cord into a wall outlet .
4. Turn on the computer.

**NOTE:** Do not place anything on power cords or cables. Arrange them so that no one may accidentally trip on them. Do not pull on a cord or cable. When unplugging from the electrical outlet, grasp the cord by the plug.

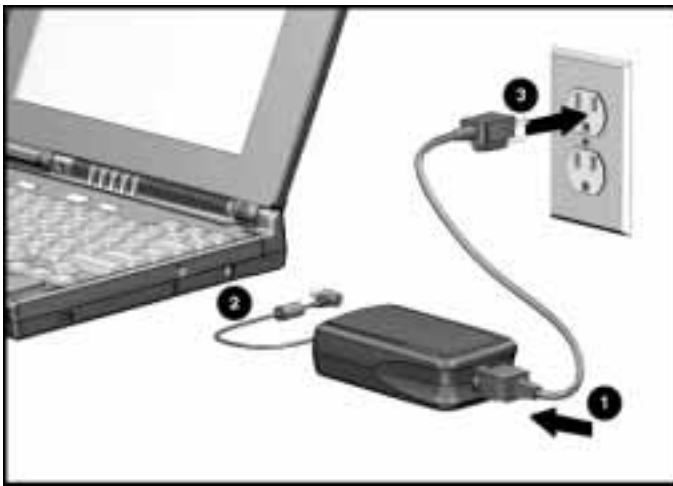

*Connecting an AC Adapter to the Computer*

**NOTE:** Keep the battery packs in the computer while you're using AC power. This supplies the battery packs with a constant charge. When the battery indicator light turns off, the battery packs are charged.

The AC Adapter is for indoor use only. Plug the AC power cord into a grounded (earthed) electrical outlet that is easily accessible at all times. Do not disable the power cord grounding plug. The grounding plug is an important safety feature.

## Battery Power

Your computer can accommodate from one to three battery packs. The three battery power sources are:

1. Modular battery pack in the DualBay—accepts lithium ion (Li-ion) battery packs.
2. Handle battery pack—accepts nickel metal hydride (NiMH) or lithium ion battery packs.
3. Modular battery pack in the Mobile CD Expansion Unit—accepts lithium ion battery packs.



**WARNING:** To reduce the risk of injury or damage to the battery pack, do not crush, puncture, or incinerate the battery pack or short the metal contacts. In addition, do not attempt to open or service the battery pack.

---

**NOTE:** Battery life varies depending on the battery type, applications in use, options connected, power conservation level enabled, operating and storage temperatures, and whether the computer components are turned on or off.

## Battery Charging/Discharging

The battery packs take several hours to charge fully when the computer is turned off and longer with the computer turned on.

All battery packs in the computer and MCD receive a charge when the system is connected to AC power. When charging occurs, the DualBay battery charges first, followed by the handle battery, and finally the MCD battery. The computer consumes power from the MCD battery and the handle battery before consuming power from the DualBay battery.

**NOTE:** Up to two battery packs at a time can be charged in the optional External Battery Charger.

## Comparing Battery Types

This computer can use two types of battery packs, nickel metal hydride (NiMH) and lithium ion (Li ion). Refer to the table below for a comparison of the battery features.

---

Comparing Battery Types	
Nickel Metal Hydride (NiMH)	Lithium Ion (Li ion)
Charges more quickly	Takes longer to charge
Shorter life span	50% longer life span than NiMH
Loses a charge more quickly	Holds a charge longer
Less expensive	More expensive

---



**WARNING:** There is a risk of fire and chemical burn if the battery pack is handled improperly. Do not disassemble, crush, puncture, short external contacts, dispose of in water or fire, or expose it to temperatures higher than 60°C (140°F). Replace only with the Compaq battery pack for this computer.

---

## Resolving a Low-Battery Condition

When you operate the computer on battery power and the battery charge runs low, the computer beeps (unless speakers have been turned off or disabled) and the battery charge indicator on the status panel begins to blink. These signs indicate a low-battery condition. When this occurs, save all work immediately and initiate Hibernation. Resolve the low-battery condition with a fully charged battery pack or external power.

### Resolving a low-battery condition with external power

If you are near a power source, connect the AC Adapter or the auto adapter to the computer until a fully charged battery can be installed.

### Resolving a low-battery condition with a charged battery pack

If a fully charged battery pack is available, do the following:

1. To avoid interrupting work, initiate Hibernation by pressing **Fn+** the suspend button. Hibernation is complete when the battery charge indicator and power/suspend lights turn off.
2. Remove the discharged battery pack.
3. Insert a fully charged battery pack in the computer or portable expansion unit.
4. Exit Hibernation by pressing the power button once. The power/suspend light turns on to indicate that full power is restored.

### Resolving a low-battery condition when a battery pack is unavailable

If a fully charged battery pack is not available, do the following:

1. Save your information.
2. Exit your applications.
3. Turn off the computer by clicking Shut Down from the Windows Start menu or initiate Hibernation until external power or a fully charged battery pack is available.

## Extending Battery Pack Operating Time

Battery pack operating time can be extended by following these guidelines:

- Select the High level of power conservation. See “Setting Battery Conservation Levels” in this chapter.
- Initiate Suspend or Hibernation or turn off the computer when not in use for several hours.
- Reduce the brightness of the display.
- Select a shorter screen save timeout.
- Avoid unnecessary fast-charge cycles, which reduce the cycle life of the battery.
- Keep a battery pack in the computer when using it with external power to supply it with a constant charge.
- When not in use, any external equipment without its own power source should be disconnected to avoid draining the battery pack.
- Exit modem programs when not in use.
- Remove the PC Card when not in use or turn off power to the PC Card slots. See Chapter 10, “Connecting External Devices,” for more information about PC Cards.
- Store the battery pack in a cool, dry place when not in use. High temperatures reduce the life of the battery pack and cause it to lose its charge more quickly. If you are storing the battery for less than one month, the recommended storage temperature is 32°F-122°F (0°C to 50°C); for no more than three months, the recommended temperature is 32°F-104°F (0°C to 40°C); for an unlimited time, the recommended temperature is 32°F-86°F (0°C to 30°C).
- Use the AC Adapter when possible.



# About Your Power Management Features

To extend the battery life and hard drive performance of your Armada Personal Computer, Compaq strongly recommends you do the following:

- Leave your power management settings enabled, as shipped from Compaq.
- If the hard drive timeout is set to zero minutes in the **F10** Computer Setup utility, or to Off in the Custom battery conservation setting in Windows 95, change these settings to more conservative values.
- Set the hard drive, screen saver, processor speed, and display brightness features to conservative settings.
- Enable your Hibernation feature to protect your data.

## Charging the Battery Pack(s)

Follow these steps to fully charge battery packs:

1. Connect the AC Adapter to the computer, then into an electrical outlet. Or connect the computer to the Automobile Adapter or dock the computer in the convenience base.
2. Turn on the computer if you want to use it while the battery packs are charging.
3. If more than one battery is installed in the system, only one battery will charge at a time, beginning with the battery pack in the computer DualBay, then the battery pack in the handle, and finally the battery pack in the Mobile CD Expansion Unit (MCD).

The battery packs take several hours to fully charge with the computer turned off and longer with the computer turned on. The battery light on the computer turns on when a battery pack in the computer is charging or awaiting a charge. When the battery packs are fully charged, the battery light turns off.

After the battery packs are fully charged, the computer maintains the batteries' charge as long as the computer is connected to external power.

## Recycling Used Batteries in North America

Disposal of nickel metal hydride or lithium ion battery packs should comply with country, state, province, or local regulations.

The battery recycling program provides a safe and easy method for disposing of used batteries. Check the Worldwide Telephone Numbers in Appendix A, “Compaq Customer Support,” to take advantage of the battery recycling program. You will be provided with a postage-paid battery pack mailer that is preaddressed to a reclamation facility where the metals are recycled.



**WARNING:** To reduce the risk of injury or damage to the battery pack, do not crush, puncture, or incinerate the battery pack or short the metal contacts. In addition, do not attempt to open or service the battery pack.

---

## Recycling Used Batteries in Europe

Disposal of nickel metal hydride or lithium ion battery packs should comply with the country, state, provincial, or local regulations.

The battery recycling program provides a safe and easy method for disposing of used batteries. Check with your Compaq authorized service provider to take advantage of the battery take-back program.

# Power Properties Utility

This computer comes standard with Power Properties, a collection of power management features that allow you to extend battery operating time or conserve AC power.

**NOTE:** Under Windows NT, this utility is available as Power Management.

You can use power management to monitor most of the computer components, such as the hard drive, processor, and display. When these components are inactive for specified periods of time, called timeouts, you can use power management settings to shut them down temporarily. This will conserve battery or AC power.

Most power management features are located in Power Properties. Using these features, you can change characteristics that determine how your system uses battery and AC power.

If you are running Windows 95, view or set your power management features in Power Properties.

To get to Power Properties:

1. Click Start.
2. Click Settings.
3. Click Control Panel.
4. Double-click the Power icon.

If you are running Windows NT, view or set power management features in Computer Setup. In Computer Setup, click the Power Management tab.

Some power management features for Windows 95 and Windows NT can be accessed from Power Properties (the power icon) on the Control Panel. Other power management features for these operating systems must be accessed in Computer Setup.

<b>If You Want To:</b>	<b>Click This Tab in Power Properties</b>
Show Suspend on the Start menu or battery meter on the taskbar.	Power (Windows 95 only)
Set timeouts for drives when using battery power or AC power.	Disk Drives (Windows 95 only)
Turn off power to the PC Card slots.	PC Card Modems (Windows 95 only)
Set battery conservation levels; enable/disable warning beeps; set timeouts.	Battery Conservation Settings
Select Hibernation settings; set Hibernation timeout.	Hibernation
Enable/disable Energy Saver and customize Energy Save monitor values.	AC Energy Saver (Windows NT only)
Display the status of installed batteries.	Battery Status
Set date and time to exit Suspend; enable/disable Resume Timer.	Resume Timer

## Battery Status Tab

The Battery Status Tab on the Power icon is a Compaq application for Windows that provides information on the status of each installed battery. The utility includes: an illustration of each battery, showing where it's installed in the computer; the life remaining in each battery; and which battery (if any) is currently charging.

## Setting Battery Conservation Levels

To extend the life of your battery, customize the level of battery conservation or click one of three preset conservation levels. Medium, the factory setting, is in effect until you change it.

You can change the default levels of battery conservation by pressing **Fn+F7** to display a popup window indicating the current level. Use the left or right arrow keys to select a different level.

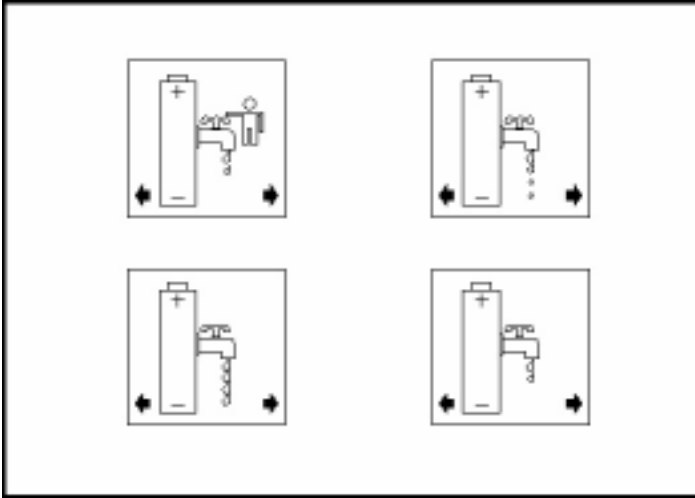

*Battery Conservation Levels*

- **High Conservation:** Saves the most battery power. This level supplies the most battery life from a single charge.
- **Medium Conservation:** Provides a balance between system performance and battery life. This is the factory setting.
- **None (Drain):** Turns off battery conservation features, and the system runs at full speed. Hibernation is factory-enabled on your computer, so that your system initiates Hibernation automatically when it reaches a low-battery condition. *However, if you manually disable Hibernation and set battery conservation to None (Drain), the computer will not initiate Hibernation automatically.*



**CAUTION:** Before setting your battery conservation level to None (Drain), make sure the Hibernation feature has not been disabled.

■ **Custom:** Saves battery power according to your specifications by setting timeouts. This setting remains in effect until you change it. (*See the following section for more information on timeouts.*)

**NOTE:** High, Medium, None, (Drain), or Custom settings remain in effect until you change them.

## Setting a Timeout

Timeouts are specified periods of system or component inactivity designed to conserve power. When a timeout period has expired, battery conservation shuts down the system or the specified components to save power.

For example, the hard disk idle default timeout is two minutes. If an application does not access information on the hard disk for two minutes, the hard disk shuts down until it is accessed again.

Timeouts are set through the Conservation Settings or Hibernation tabs in Power Properties. Use timeouts in the following ways:

1. Use a preset timeout provided with the medium (default) or high level of battery conservation.
2. Set your own timeouts through the custom level of battery conservation so that the computer works more efficiently with your applications.

**NOTE:** Programs with the autosave feature, or those that automatically write data to the hard disk, can cause the hard disk timer to reset when data is written to the hard disk.

## Turning Hibernation On or Off

Hibernation is automatically turned on when you first set up your computer. In order for Hibernation to work, it must allocate space on your hard drive equal to the amount of RAM installed. To free up this disk space, you can click the Hibernation tab in Power Properties and turn off Hibernation. However, Compaq does not recommend this, because it could result in lost data.



**CAUTION:** Turning off Hibernation is not recommended. If the computer reaches a low-battery condition and Hibernation is turned off, unsaved information is lost.

---

When you restart the computer, the system first upgrades your memory, then should automatically allocate or update your computer's disk space to adjust to the new amount of memory. However, if you experience problems with Hibernation after upgrading your memory, run the Power Conservation utility and click the Hibernation tab to reset the system memory.

## The Battery Gauge Popup

Press the **Fn+F8** hotkeys to display the Battery Gauge popup window. This shows the percentage of battery charge remaining for each battery in your system. The Battery Gauge Popup displays three numbered boxes, each representing a specific battery:

- Box 1, the modular battery in the DualBay.
- Box 2, the handle battery.
- Box 3, the battery in the Mobile CD Expansion Unit (MCD).

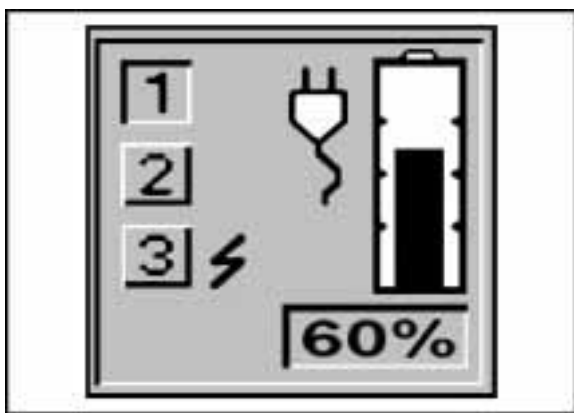

*Battery Gauge Popup*

Press **Fn+** the right or down arrow key to view the status of the next battery. Press the **Fn+** the left or up arrow key to select the previous battery. Batteries not present cannot be selected.

The box representing the selected battery will be indented. A battery not present in the system will display a gray number. If the selected battery is charging, a lightning bolt appears to the right. The graphic displays the remaining battery capacity, also shown as a percentage. In the popup shown above, the battery in the dual bay has 60 percent remaining capacity. The modular battery in the MCD is charging.

**NOTE:** If you do not depress any arrow keys for five to seven seconds, the Battery Gauge popup will display the average remaining capacity of all installed batteries.



# *chapter* 6

## USING THE HANDLE

The removable handle comes installed with a battery to extend the run time of your computer. The handle also gives your computer more portability and added functionality.

This chapter describes the following:

- Handle functions
- Attaching the handle
- Detaching the handle
- Handle tilt feature
- Removing/Inserting the handle battery

### Handle Functions

The handle is a multifunctional feature of your computer. To provide more portable power, the handle houses an additional battery pack. In addition, the handle moves to three convenient positions:

- Creates a comfortable tilt for working at the keyboard. Fold the handle back and under the computer. (See “Handle Tilt Feature” later in this chapter for details.)
- Provides a cover for the rear connectors. Place the handle in a straight position while the computer is lying flat.
- Enables you to carry the computer like a briefcase.

# Attaching the Handle

To attach the handle to the computer, follow these steps:

1. Remove the battery, if installed. (See “Removing/Inserting the Handle Battery” in this chapter for instructions on removing the battery.)
2. If a charged battery is installed in the DualBay, initiate Suspend. (If not, initiate Hibernation by pressing **Fn+ suspend**.) Close the computer, detach external devices, and turn it over, bottom side up.
3. Line up the notches in the metal part of the handle with the slots on the back of the computer.

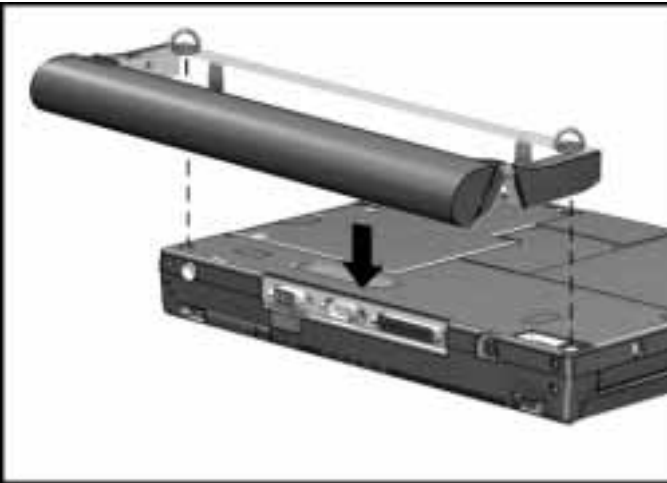

*Attaching the Handle to the Computer*

4. Tighten the thumbscrews on the handle by turning them clockwise.

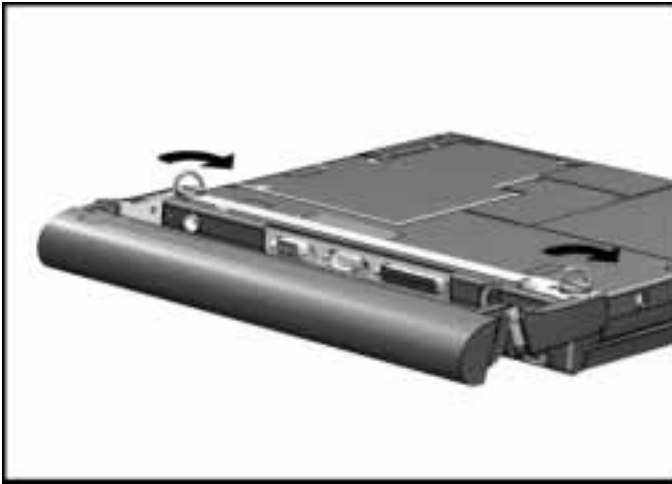

*Turning Thumbscrews to Tighten Handle*

5. Insert the battery. (See “Removing/Inserting the Handle Battery,” in this chapter for instructions on inserting the battery.)
6. Turn the computer over, open the display, attach external devices, and press the suspend button to exit Suspend (or press **Power** to exit Hibernation).

## Detaching the Handle



**CAUTION:** If no other battery is installed and the computer is not attached to external power, save your work, exit all applications, turn off the computer, and disconnect external devices.

---

To remove the handle from the computer, follow these steps:

1. Exit all applications, disconnect all external devices, and turn off the computer.
2. Close the computer and turn it over, bottom side up, with the handle in the carry position.

3. Remove the battery from the handle. (See “Removing/Inserting the Handle Battery,” in this chapter for instructions.)
4. Loosen the thumbscrews by turning them counterclockwise.

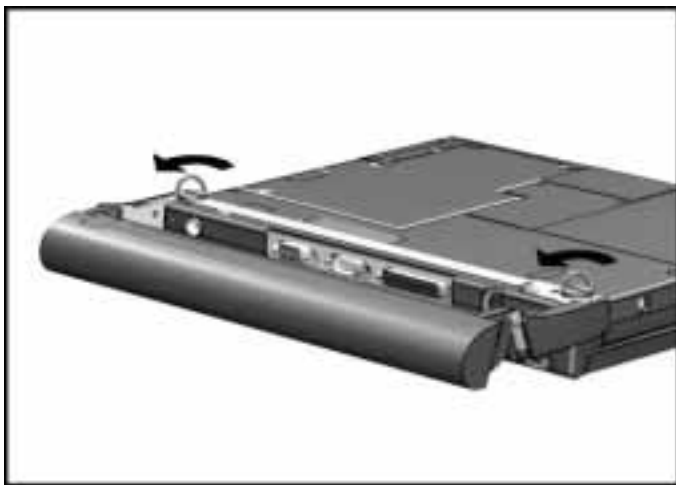

*Turning Thumbscrews to Loosen Handle*

5. Lift the handle and remove.

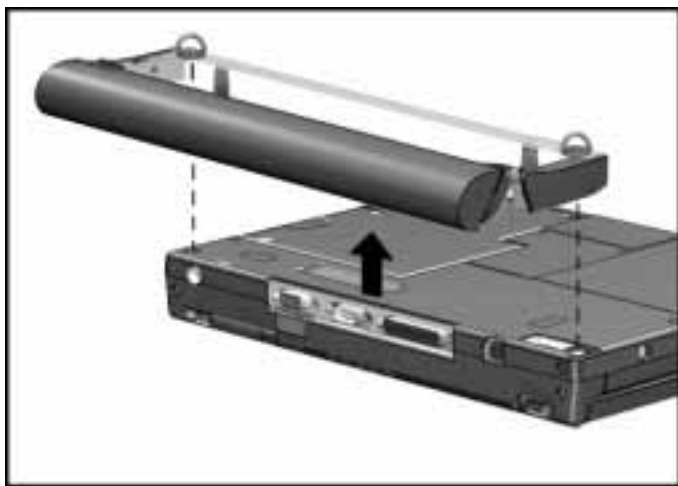

*Removing the Handle*

6. Turn the computer over, open the display, turn on the computer, and attach external devices.

## Handle Tilt Feature

The versatile handle can also be rotated back and under your computer. This tilts the keyboard slightly, making typing more comfortable.



*Keyboard Tilt Feature*

## Removing/Inserting the Handle Battery



**CAUTION:** If no other battery is installed and the computer is not attached to external power, save your work, exit all applications, turn off the computer, and disconnect external devices.

---

To remove the battery pack from the handle whether it is attached or detached from the computer:

1. If it is attached to the computer, lay the computer flat with the handle in the carry position.

2. Grasp the handle battery cap on the top and bottom and pull the battery out of the handle.

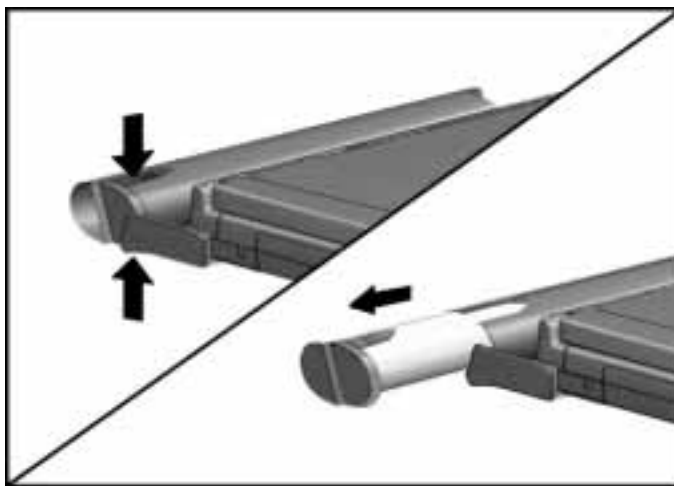

*Removing the Battery from the Handle*

**IMPORTANT:** Battery components are considered environmentally harmful. Disposal of used battery packs should comply with country, state, provincial, or local regulations. Refer to information on recycling used battery packs in Chapter 5.

3. To insert the battery, ensure that the battery contacts are facing in toward the computer.
4. Insert a fully charged battery pack into the handle until it clicks into place.



*Inserting a Battery Pack in the Handle*

# chapter 7

## USING THE DUALBAY

The DualBay on your computer can accommodate either the diskette drive or the modular battery pack.

This chapter includes information on:

- Removing/Inserting the diskette drive
- Inserting a diskette
- Removing a diskette
- Removing/Inserting the modular battery pack

**NOTE:** For details on using the diskette drive externally, see Chapter 8, “Using the External Diskette Drive Bay.”



# Inserting/Removing the Diskette Drive

To insert the diskette drive into the DualBay, follow these steps:



**NOTE:** If the modular battery is installed, remove it before inserting the diskette drive.

1. Initiate Suspend by pressing the suspend button.
2. Align the diskette drive with the metal rails in the DualBay.
3. Push the diskette drive into the computer until it clicks into place.
4. Exit Suspend by pressing the suspend button.



*Inserting the Diskette Drive into the DualBay*

To remove the diskette drive from the DualBay, follow these steps:

1. If the computer is turned on, initiate Suspend by pressing the suspend button once.
2. Press the DualBay eject button  on the right side of the computer.
3. Pull the diskette drive  from the DualBay.



*Removing the Diskette Drive from the DualBay*

4. Exit Suspend by pressing the suspend button to return your information to the screen.

## Inserting a Diskette

To insert a 3.5-inch diskette into the diskette drive, hold the diskette by the edge that contains the label. With the label facing up, gently push the diskette, metal end first, into the diskette drive until it clicks into place. If the diskette is inserted correctly, it drops into position in the diskette drive and the diskette drive button pops out.

## Removing a Diskette

To remove a diskette, press the diskette drive button. When the diskette pops out slightly, gently pull the diskette out of the drive.

**NOTE:** Insert and remove diskettes from the external diskette drive using these same procedures.



# Removing/Inserting the Modular Battery

The modular battery is used in the DualBay of your computer. To remove the modular battery, follow these steps:



**CAUTION:** If no other battery is installed and the computer is not attached to external power, save your work, exit all applications, turn off the computer, and disconnect external devices.

---

1. Press the DualBay eject button  on the right side of the computer.
2. Pull the modular battery  out of the DualBay.



*Removing the DualBay Battery*

To insert the modular battery into the DualBay, follow these steps:

1. To insert a fully charged battery pack, ensure that the label on the battery pack is facing up and the battery contacts facing the computer.

2. Align the battery pack with the metal rails in the DualBay and push the battery pack into the computer until it clicks into place.



*Inserting the Modular Battery into the DualBay*

**NOTE:** For directions on removing and inserting a battery pack in the MCD, refer to the documentation that comes with the MCD.

# chapter 8

## USING THE EXTERNAL DISKETTE DRIVE BAY

When you want to place a modular battery pack in the DualBay but also need the diskette drive, you can use the external diskette drive by connecting it to the parallel port.

This chapter includes information on:

- Inserting the diskette drive into the external diskette drive bay
- Removing the diskette drive from the external diskette drive bay

**NOTE:** For instructions on inserting and removing a diskette, see Chapter 7, “Using the DualBay.”

**NOTE:** The external diskette drive cannot be used if the computer is attached to the optional convenience base. The diskette drive can be used in the DualBay instead.

# Inserting the Diskette Drive into the External Diskette Drive Bay

With the external diskette drive bay connected to the parallel port on the rear of the computer, insert the diskette drive by following these steps:

1. Align the diskette drive with the rails in the external diskette drive.
2. Insert the drive into the drive bay until it clicks into place.

**NOTE:** The computer can be turned on or off when connecting the external drive bay.

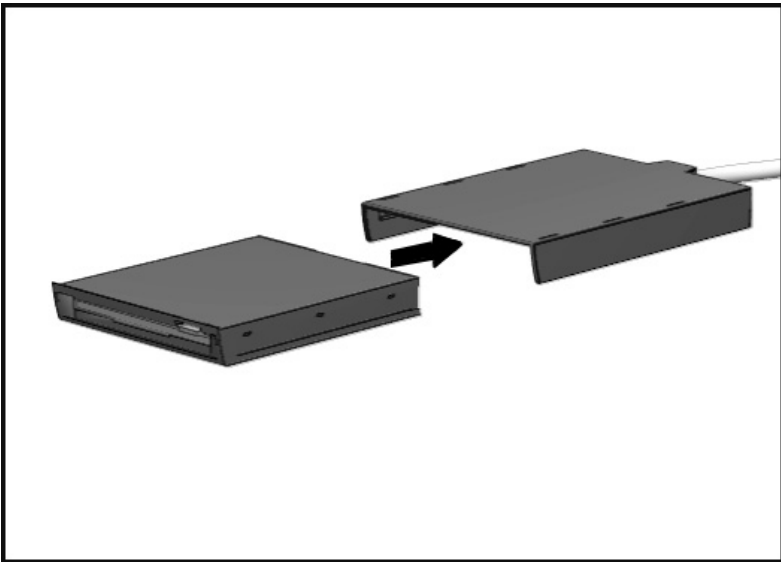

*Inserting the Diskette Drive into the External Bay*

# Removing the Diskette Drive from the External Diskette Drive Bay

To remove the diskette drive from the External Diskette Drive Bay, follow these steps:

1. Disconnect the cable on the external drive bay from the rear of the computer.
2. Slide the diskette drive out of the external drive bay.

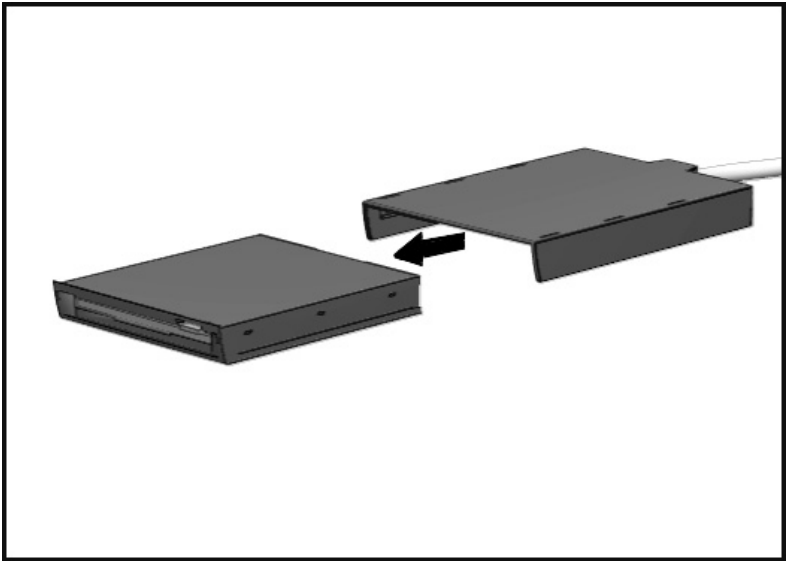

*Removing the Diskette Drive from the External Drive Bay*



# chapter 9

## ENJOYING COMPAQ AUDIO

Your computer has both internal and external audio capabilities that allow you to record, play back, and edit voice, music, and other sounds in digital audio files.

These capabilities allow you to take advantage of the newest business programs, presentation software, and multimedia educational and entertainment software. This chapter familiarizes you with the audio features on the computer, including:

- Audio components
- Internal/external microphones
- Audio volume/audio software
- Stereo speakers



# Identifying Built-In Audio Components

The computer features the following audio components:

- Internal electric condenser microphone with standard sensitivity of 67 dB.
- Internal stereo speakers on the computer (and on the Mobile CD Expansion Unit, MCD).
- Output jacks for external stereo headphones or speakers that have a 3.5-mm, 3-conductor plug.
- External microphone input jack that accepts a 2-conductor, 3.5-mm plug from an electret condenser microphone.
- External audio input jack that accepts a 3-conductor, 3.5-mm plug.

## External Audio Jacks

The computer allows you to connect external equipment to enhance a multimedia presentation or quietly enjoy your favorite CDs using the following connectors:

- Mono microphone jack  can also be used to record voice or sound through an external electret condenser microphone.
- Stereo speaker/headphone jack  supports stereo headphones or external stereo speakers.
- Stereo line-in jack  accepts sounds from external audio devices such as a CD player, tape deck, or tuner.

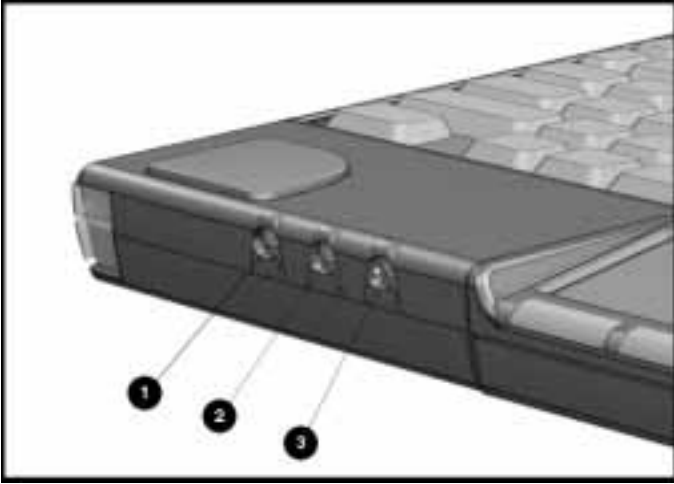

*Audio Jacks*

## Stereo Line-In Jack

The stereo line-in jack is the input line for devices such as a CD player, tape player, or tuner. The input device must supply levels compliant with the line input level specification of 0.5 to 4.25 volts. The line output of most devices meets this specification.

Make sure you plug in a stereo component only to your computer. A stereo connector has a colored band. The mono plug does not.



**CAUTION:** Use only a 3.5-mm stereo plug in the stereo line-in jack, which has a colored band around the connector post. A mono plug used in the stereo line-in jack may damage the input device.

---

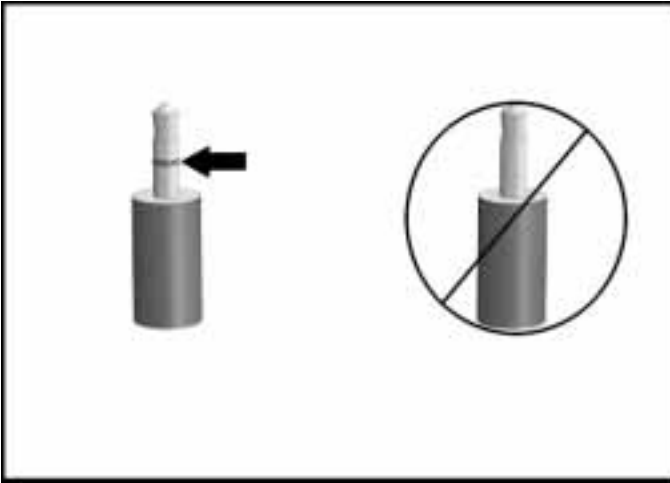

*Stereo Plug Versus Mono Plug*

## Internal Microphone

You can record voice or sound through the internal mono microphone  or by plugging an external electret condenser microphone into the mono microphone jack. The internal microphone also supports speakerphone features.

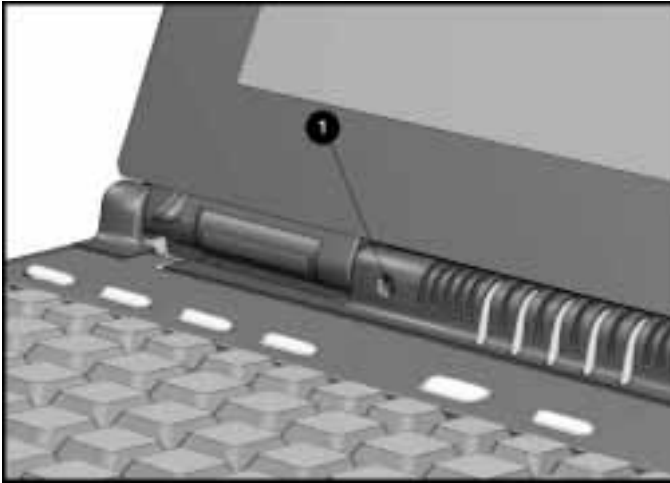

*Internal Microphone*

# Volume Control

The volume control hotkeys, **Fn+F5**, adjust the computer volume up or down (using the arrow keys), and are the master volume control for your computer. Volume is also controlled by a Windows utility, the Audio icon, in the Control Panel on the Windows Start menu.

**NOTE:** There is no manual volume control on the computer. Volume can only be controlled by the software.



**WARNING:** To reduce the risk of personal injury, adjust the volume control before putting on headphones.

---

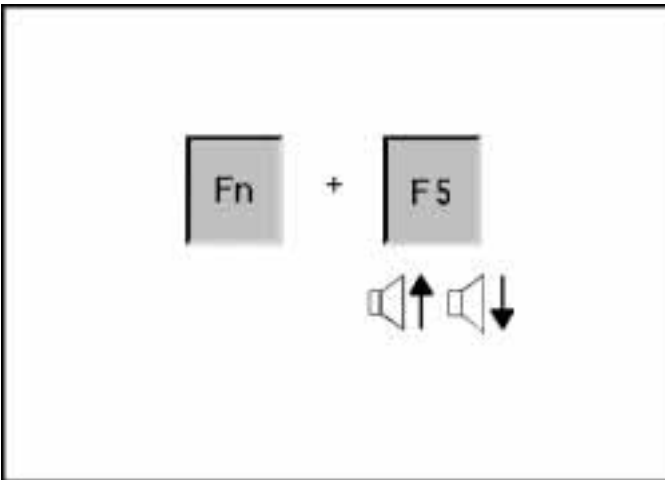

*Volume Control with Hotkeys*

# Using the Stereo Speakers

The integrated stereo speakers  support playback of recorded sounds, audio for games and business programs, and line-out devices such as a CD player, tape deck, or stereo tuner.

The speakers are disabled when you connect external speakers or headphones to the stereo speaker/headphone jack. Speakers are also disabled when you attach the computer to the Mobile CD Expansion Unit (MCD).

If the computer is attached to the MCD, the system audio is played through the MCD speakers .

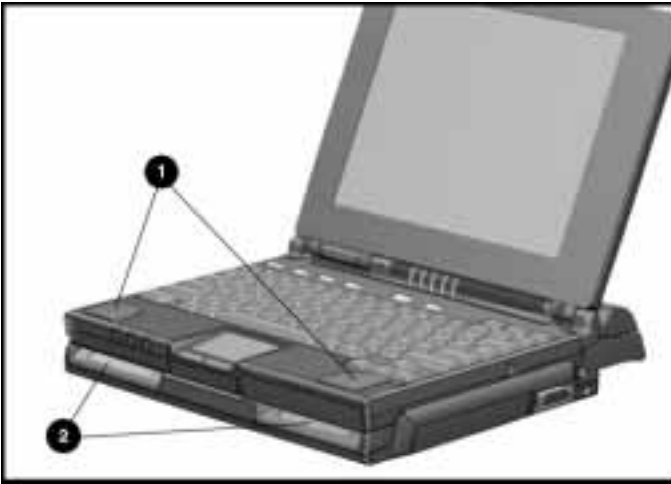

*Speakers on the Computer and MCD*

**NOTE:** Some software applications, such as game programs, include their own volume controls. You may need to make adjustments within these applications to get the desired sound levels.

**IMPORTANT:** If volume is turned down, low-battery beeps may not be audible.

# chapter 10

## CONNECTING EXTERNAL DEVICES

To enhance the functionality of your computer, connectors on the rear of the computer support numerous external devices. This chapter familiarizes you with the utilities and procedures needed for connecting or configuring external equipment to your computer, using the following:

- Configuration utilities
- Using PC Cards
- Connecting video
- Connecting infrared equipment

**NOTE:** For more complete information about connecting an external monitor, pointing device, keyboard, printer, or other options, see your online *Compaq Reference Guide*.



# Configuration Utilities

## Device Manager Utility

Device Manager is the primary tool for viewing and manipulating your system configuration. It allows you to view your external equipment and internal devices, including keyboard, modem, disk drives, and monitor. To get to Device Manager, click Start → Settings → Control Panel → Systems → Device Manager.

The Device Manager allows you to view and change your system configuration in the following ways:

<b>If You Want To:</b>	<b>Click This Tab:</b>
Look at system resources or print out a system summary	View Devices by Type
Change drivers; install drivers; learn the status and compatibility of installed devices	View Devices by Connection

## Add New Hardware Utility

The Add New Hardware utility helps you install a new piece of hardware quickly. Also, it will automatically detect installed hardware. To get to the Add New Hardware utility, click Start → Settings → Control Panel → Add New Hardware. Follow the instructions on the screen.

# Using PC Cards

Your computer is equipped with a versatile feature that allows you to connect portable external devices, such as modem, memory, or network PC Cards. The PC Card slots on your computer can accommodate (at the same time) two Type I, two Type II, or one Type III PC Card. Your computer, running Windows 95 or Windows NT, can accommodate 16-bit or 32-bit (CardBus) PC Cards.

**NOTE:** A Type III PC Card fits only in the bottom slot, slot 1.

**IMPORTANT:** Before buying a non-Compaq PC Card, be sure it is on the Compaq PC Card Solutions List. The Premier PC Cards are qualified on all portable systems and operating systems. The latest copy can be found on the Compaq web site <http://www.compaq.com/support/techpubs/pcmcia/pccardlist.html>

Also, look for the Compaq PC Card Solution logo shown in the diagram. Cards with this logo on their packaging and advertising have been qualified for use on Compaq computers.



*Compaq PC Card Solution Logo*

## Understanding Plug and Play

If you are running Windows 95, you do not need to turn off the computer before inserting or removing a PC Card. If the computer is on, it will automatically configure most PC Cards. For example, a modem/fax card is configured to a COM port, while a storage card is assigned a drive letter. If the computer is turned off or is in Suspend, the card will not be configured until the computer is powered on.

If you are running Windows NT, turn off the computer before inserting or removing a PC Card. Since Windows NT is not Plug and Play, it can only recognize hardware configuration changes (devices added or removed) during computer power-up.

## Managing PC Card Power

PC Cards are power options in a small form factor. When PC Cards are installed in your computer, they draw power from the system even when they are not in use.

If you are running Windows 95, remove PC Cards when they are not in use to conserve power, or you may turn off power to the PC Card slots through Power Properties. If you are running Windows NT, remove PC Cards when they are not in use to conserve power.

If you are operating the computer on a battery pack, disable power to the PC Card slots to extend battery life. You can also turn off power to the PC Card slot when the computer is in Suspend.

## Inserting a PC Card

**IMPORTANT:** See “Understanding Plug and Play” in this chapter to find out if you should turn off the computer or initiate Suspend before inserting or removing a PC Card.

To insert a PC Card, follow these steps:

1. Insert the PC Card into the PC Card slot (front left side of computer).
2. Gently push the card into the top slot, label side up. (Forcing a card into the slot can damage the connector pins.)



**IMPORTANT:** After a PC Card has been inserted and configured, you may need to perform an initial setup procedure. For example, a new storage card may need to be formatted, or a new network card may need drivers installed. For details on setup procedures for various PC Cards, refer to the instructions included with the PC Card, or call the card vendor for more information.

## Removing a PC Card



**CAUTION:** If you are using Windows 95, you should always “stop” PC Cards before removing them to prevent damage to the PC Card or to your computer.

To remove a PC Card, follow these steps:

1. Click on the PC Card icon on the system tray (taskbar).
2. When the dialog box appears, select the card to be removed and click **Stop**.
3. Windows 95 will display the message “You may safely remove this device.”
4. Press the top or bottom PC Card release button . (The release buttons are located on the front left corner of the computer.)
5. Firmly grasp the card and gently pull it out .
6. If you’re using Windows 95 with the computer turned on, the computer beeps twice to indicate card removal.

**NOTE:** If the speakers or beeps are turned off, system beeps are not audible.

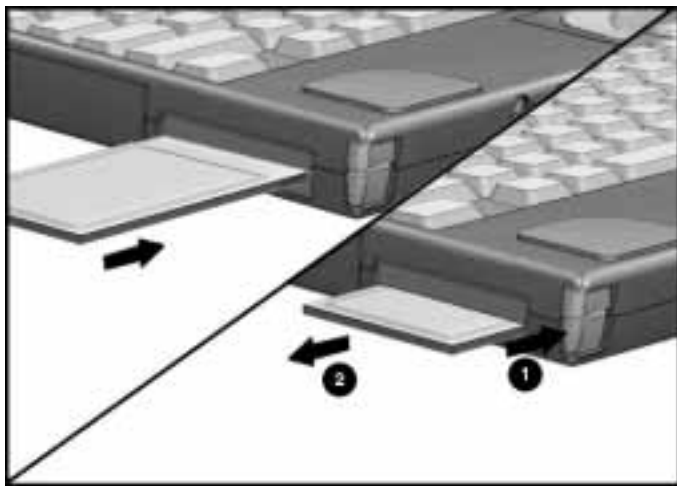

*Inserting and Removing a PC Card*

## **PC Card Software**

To manage and configure PC Cards effectively, your computer provides PC Card software. This software includes drivers for the most popular PC Cards and other features designed to make PC Cards simple to use.

## **USB CardBus PC Card**

The computer provides universal serial bus (USB) technology support. The USB CardBus PC Card lets you connect several USB peripherals with just a few cables. Insert the USB CardBus PC Card in the bottom PC Card slot on your computer.

# **Connecting Video**

## **Using the Video Utility**

To access the video utility, click the COMPAQ tab in Display Properties. This utility allows you to configure your graphics system and to select a video mode when you connect a TV, VCR, or camcorder to your computer via the NTSC/PAL cable that came with your computer.

Under the COMPAQ tab, click the TV/NTSC radio button to enable video output for U.S. video. Click the TV/PAL radio button to enable video output for European video.

## Connecting a TV or VCR

Your computer allows you to send video output to a video device (TV, VCR, or camcorder) connected to your computer. When a TV is connected, you can see presentations or videos on the TV screen. When a VCR or camcorder is connected, you can record presentations or videos.

To connect a TV or VCR to your computer, follow these steps:

1. Turn off the video equipment you wish to connect.
2. Connect the NTSC/PAL cable that came with your computer to the video connector on the back of the computer.

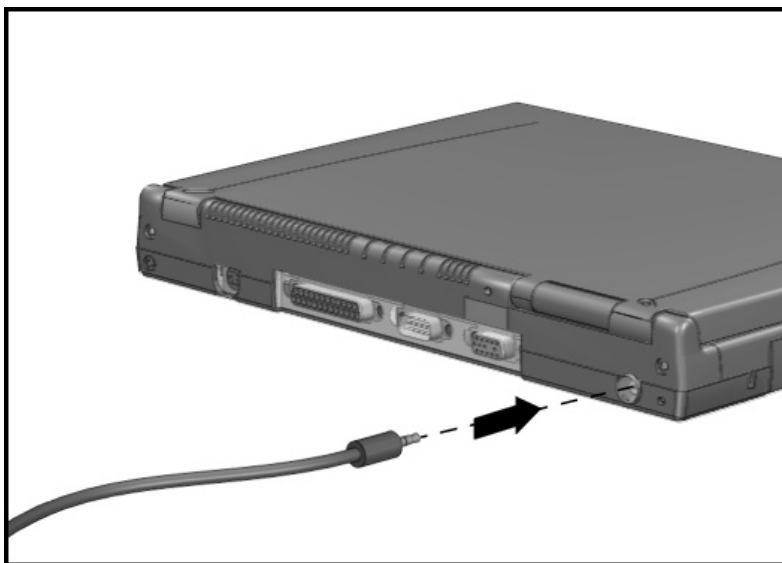

*Connecting the NTSC/PAL Cable*

3. Connect the other end of the NTSC/PAL cable to the TV or VCR you wish to connect.
4. Go to the Display icon on the Control Panel in the Windows Start menu. Choose the Compaq tab to select whether you want the picture to display on the computer, TV, or VCR.

**NOTE:** The **Fn+F4** hotkeys, which toggle the display between the computer, external monitor, or TV screen do not provide simultaneous display when video equipment is connected.

## Displaying Pictures

In Europe, you may need to purchase an adapter if your TV/VCR/camcorder has a SCART (Euro-AV) connector or if it has a BNC type connector. Please note that the aerial connector on your TV/VCR is not the same connector as the BNC and will not work with the computer.

In some countries, the pictures displayed on the TV or VCR will appear in black and white. This is because the NTSC feature that displays color pictures is not supported in countries with PAL-M and PAL-N frequency standards. These standards support black and white pictures only.



## Connecting Infrared Equipment

The infrared lens on the back of your computer uses an invisible beam of infrared light to communicate with other infrared-equipped devices, such as printers or other computers.

The Microsoft Windows Infrared (IR) communications driver enables your computer to send and receive data over these IR communications links.

The infrared monitor can be accessed by selecting the Infrared icon located on the Control Panel. The infrared monitor displays the status of any IR communication links, settings, and properties of the IR Port. For additional information, select the Help in the Infrared Monitor.

To establish an infrared link:

- Be sure that the infrared ports on both devices are turned on and facing each other at a distance no greater than 3.28 feet (one meter).
- Avoid moving the infrared ports during data transmission.
- Avoid interference from remote control units (e.g., wireless headphones or audio devices) by pointing them away from the infrared ports.
- Avoid direct sunlight, fluorescent light, or flashing incandescent light close to the infrared ports.
- Keep the path between the infrared ports free of objects (to avoid interference with data transmission).
- Do not point one port more than 30 degrees away from another port.

The computer's infrared lens can be used when the computer is attached to the Compaq Mobile CD Expansion Unit (MCD), but not when the computer is docked in the convenience base.

# chapter 11

## ADDING SOFTWARE AND UPGRADES

Upgrading your computer increases its functionality and performance. Contact your Compaq authorized reseller to determine which upgrades are available for your model. For detailed installation procedures, refer to the installation documentation included with the equipment or contact your Compaq authorized reseller.

This chapter will familiarize you with:

- Installing software
- Operating system support
- Upgrading memory
- Upgrading the hard drive

# Installing Software

An application software program performs a specific task, such as database management, word processing, financial management, or graphic illustration.

Application software is different than system software or operating systems, which maintain and organize the system. Each application program usually includes its own installation program and documented installation procedures.

Before installation, read the documentation that came with the application to ensure that your computer meets the disk space, memory, operating system, and monitor requirements of the application.

## Operating System Support

Contact your authorized Compaq service provider to obtain Compaq supplemental software and drivers if you are replacing your preinstalled operating system with another operating system.

You can also go to the Compaq Web site at [www.compaq.com](http://www.compaq.com) to obtain Compaq supplemental software.

# Upgrading Memory

This computer comes standard with 32 megabytes of system memory. You can expand memory by installing matched pairs of memory expansion boards. To order a memory expansion kit, contact your Compaq authorized reseller.

## Memory Upgrade Options

Each Memory Expansion Kit contains two matched boards which can be installed in the memory expansion slots. The following Memory Expansion Kits are available from Compaq:

- 8-Megabyte Memory Expansion Kit (contains two 4-MB boards)
- 16-Megabyte Memory Expansion Kit (contains two 8-MB boards)
- 32-Megabyte Memory Expansion Kit (contains two 16-MB boards)
- 64-Megabyte Memory Expansion Kit (contains two 32-MB boards)

## Checking Current Memory

If you are running Windows 95, view the total amount of system RAM (random access memory) available to Windows by clicking the General tab in System Properties. To display the percentage of system resources available, click the Performance tab in System Properties.

If you are running Windows NT, view the total amount of system RAM available to Windows or the percentage of system resources available by launching Windows NT Diagnostics.

## Adding Memory



**CAUTION:** If you need to remove the memory expansion boards, be sure to release the locking tabs that secure the memory boards in the slots. If the tabs are not released, the connectors may break and cause irreparable damage to the system board.

---



**CAUTION:** Electrostatic discharge can damage electronic components. Before touching a memory expansion board, ensure that you are discharged of static electricity by touching a grounded metal object.

---

To upgrade memory, follow these steps:

1. Save your work. Exit all applications and turn off the computer by clicking Shut Down from the Windows Start menu. Remove all external devices, including battery packs and the AC Adapter.
2. Remove the device from the DualBay. (See Chapter 7, “Using the DualBay,” for removal instructions.)
3. Remove the pointing device. (See Chapter 4 for removal instructions.)
4. Close the computer and turn it bottom side up.
5. Pry up the memory compartment cover and gently lift it off.

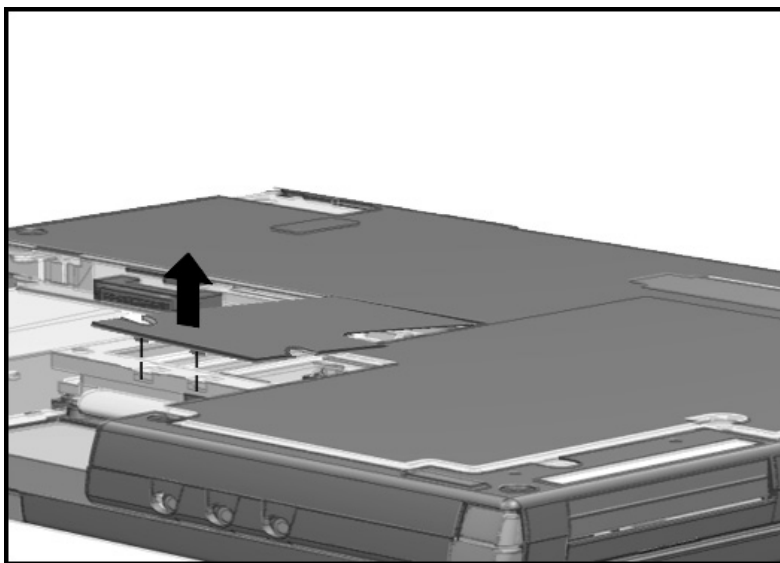

*Removing the Memory Compartment Cover*

6. Slide the first of two memory boards into the lower memory slot. Then slide the second board into the top slot. The connectors snap into place when boards are correctly seated.
7. Replace the memory compartment cover.
8. Turn the computer over again, right side up. Replace the DualBay device battery pack(s), pointing device, and reconnect external devices.
9. The computer automatically recognizes the new memory and reconfigures the system.



**CAUTION:** If you need to remove the memory expansion boards, be sure to release the locking tabs that secure the memory boards in the slots. If the tabs are not released, the connectors may break and cause irreparable damage to the system board.

---

## Upgrading the Hard Drive

Depending on your computer model, the hard drive can be upgraded to a larger capacity. Contact your Compaq authorized dealer, reseller, or service provider for the optional hard drives available for your computer.

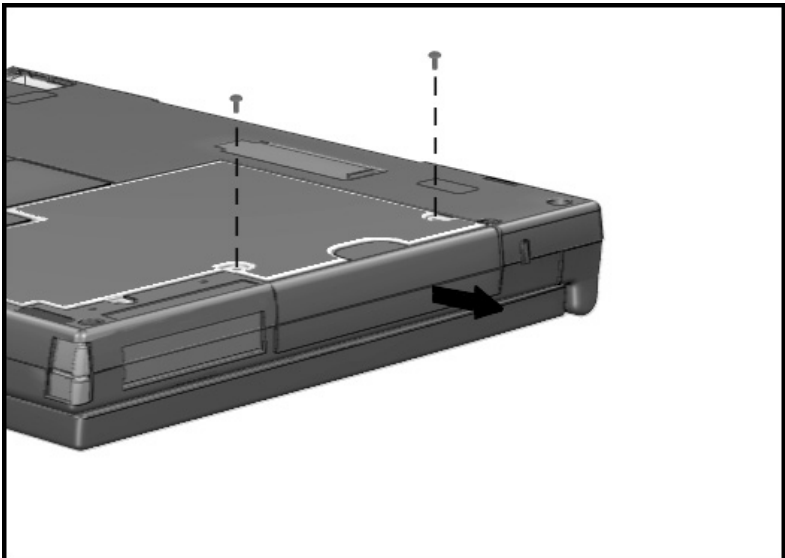

*Accessing the Hard Drive Compartment*

# chapter 12

## SETTING SECURITY FEATURES

The security features installed on your computer allow you to customize the security measures you prefer. The computer provides security features to set passwords, lock the pointing device and keyboard, and blank the screen.

This chapter describes how to set and modify the following security features:

- Passwords properties
- Power-on password
- Setup password
- Quick controls
- Cable lock

# Setting Passwords Properties

The Passwords icon allows you to protect your computer against unauthorized use. To ensure privacy and security, you can set or change passwords, disable the keyboard and pointing device, or blank the screen while you are away from your computer.

To get to the Passwords icon:

1. Click Start.
2. Click Settings.
3. Click Control Panel.
4. Double-click the Passwords icon.

Passwords Properties lets you set the following:

If You Want To:	Click This Tab:
Initial setting of power-on password; enabling of QuickLock and QuickBlank	Computer Security

## Power-On Password

Power-on password is a security feature that prevents use of the computer when it is turned on until a secret word or code is entered. This prevents unauthorized access to your information.

Once you establish a power-on password, you must enter it each time you turn on the computer.

**IMPORTANT:** You cannot use the computer if you forget your power-on password. Therefore, Compaq recommends that you record your password and put it in a safe place.

### Establishing a Power-On Password

To establish your power-on password, follow these steps:

1. Click the Computer Security tab in Passwords Properties.
2. Click the Set button.
3. Enter your password twice, then click OK.



You may enter up to seven alphanumeric characters for the password. The next time you restart the computer, you will be prompted to enter your power-on password.

**IMPORTANT:** Type carefully, because the password does not display as you type it. The password is not case sensitive. However, you must use the same keys each time you enter the password. For example, the numbers at the top of the keyboard are not recognized as being the same as the numbers in the embedded numeric keypad.

## Entering the Power-On Password

To enter a power-on password, follow these steps:

1. Turn on the computer.
2. When the power-on password prompt is displayed, type your power-on password carefully. The prompt symbol is a key icon. If you enter your password incorrectly, an incorrect password prompt, a key with an “X” over it, is displayed.
3. Try again to enter the password. After three unsuccessful attempts, you must Shut Down the computer and Restart before you can continue.

## Deleting/Changing Power-On Password

Once your power-on password has been established, you can delete or change it using your computer keyboard. On most keyboards, the slash mark (/) is the key character used, but the syntax for deleting/changing the power-on password varies according to the language of your keyboard. To change your password, type in the old password, enter the slash mark, and enter the new password.

Each computer keyboard is designed to meet specific country requirements. As a result, you may have to substitute another key character. Refer to the online *Compaq Reference Guide* for more information.

## If You Forget Your Power-On Password

If you forget your power-on password, the computer must be disassembled and the memory cleared. Contact your Compaq authorized dealer, reseller, or service provider for assistance.

# Establishing a Setup Password

A setup password allows you to protect your system configuration. Once this password is established, you cannot change the configuration until you enter the password. The setup password should be used by network administrators or anyone who needs to protect the system configuration from unauthorized use.

The setup password can only be set, changed, or deleted from the **F10** Setup utility. To establish the setup password for the first time follow these steps:

1. Restart the computer by clicking Shut Down from the Windows Start menu.
2. When the cursor moves to the upper right corner of the display, press F10. When the Compaq Utilities menu appears, click Computer Setup, System Features, then Security Management.
3. In the window that appears, type the password in the New Password field. Type it again in the Retype Password field and exit the utility by clicking OK.

**IMPORTANT:** Type carefully, because the password does not display as you type.



**CAUTION:** If you forget your setup password, you will need to clear the password from memory before you can reconfigure the system. Call your Compaq authorized dealer, reseller, or service provider for assistance.

---

## Deleting/Changing a Setup Password

To delete/change a Setup Password, follow these steps:

1. Restart the computer by clicking Shut Down from the Windows Start menu.
2. The password prompt is displayed when you press F10 after restarting the computer.

**IMPORTANT:** Type carefully, for security reasons, the characters you type do not appear on the screen.

**To delete your password**, enter your current password, followed by the appropriate syntax for your computer keyboard. For example, if you have a Belgian keyboard, type the following to delete the password:

current password=

**To change your password**, enter your current password, then enter the new password twice, typing the appropriate syntax for your computer keyboard between the passwords. For example, if you have a Belgian keyboard, you will type the following:

current password=new password=new password

The new password takes effect the next time you turn on the computer.

**NOTE:** The syntax for changing the password varies according to your keyboard. Refer to the online *Compaq Reference Guide* to find the syntax for your computer.

## Identifying Quick Controls

Quick Controls establish security measures on your computer when it is on, but not in use.

- **QuickLock**—Locks the keyboard and pointing device while the computer is running. It leaves your data on the screen, but prevents it from being accessed by the keyboard until a power-on password is entered.
- **QuickBlank**—Used in conjunction with QuickLock, clears the screen when the keyboard and pointing device are disabled.
- **QuickLock on Standby**—Locks the keyboard when the machine enters Suspend.

- **QuickBoot**—Enables the computer to start up quickly, minimizing POST. To disable QuickBoot and let the computer complete all power-on tests, restart the computer. Then press **F10** as soon as the cursor appears in the upper-right corner of the screen. Select Computer Setup, System Features, then Boot Management. Click the Enable QuickBoot box to disable or enable this feature.

## Initiating Quick Controls

After setting the power-on password in Passwords Properties, Quick Controls can be initiated in two ways:

- With **Fn+F6** hotkeys, which work only on the computer keyboard.
- With the key combination **Ctrl+Alt+L**, which works on both the computer and external keyboards.

**NOTE:** To exit QuickLock/QuickBlank once it has been activated, enter your power-on password.

## Using a Cable Lock

In order to secure your computer and prevent it from being stolen or accidentally disconnected, you may want to use a cable lock. A cable lock can be purchased from Kensington Microware Limited and major dealers worldwide. Ask for the Kensington MicroSaver Security System Model 64068.



*Installing a Cable Lock*

To attach the cable lock:

1. Loop the cable around a fixed object to which you want to secure the computer.
2. Insert the lock end of the cable through the loop end of the cable.
3. Insert the key into the lock and turn it.

# chapter 13

## CARING FOR THE COMPUTER

This chapter provides Compaq recommended guidelines for taking care of your computer. These guidelines, aimed at ensuring your computer's longevity and reducing the risk of damage, include:

- Routine care
- Travel guidelines
- Shipping guidelines

# Routine Care

You can keep the computer in good condition and working properly by following these guidelines:

- Operate the computer with a battery pack installed, even when you're using external power. This supplies the battery with a constant trickle charge and ensures a fully charged battery pack the next time you turn on the computer.
- Keep the computer away from excessive moisture and temperature extremes. Do not expose the computer to liquids or precipitation.
- Remove the battery pack from the computer if the computer will not be used for an extended period. Store the battery pack in a cool, dry place when it is not in use.
- To prevent possible damage to the display, do not place anything on top of the computer when it is closed. Store the computer in the slipcase, but do not store any other items inside the case on top of the computer.
- Occasionally wipe the exterior of the computer and the screen with a soft, damp cloth moistened only with water.
- Avoid exposing the computer to direct sunlight or strong ultraviolet light for extended periods of time. Also avoid scratching the surface of the screen and banging it against hard objects.



**CAUTION:** Using soap or other cleaning products on the screen may discolor the finish and damage the screen. Do not spray liquid directly on the computer screen. Excess liquid may drip down inside the computer and cause damage to the components or result in electrical shock.

---

# Travel Guidelines

For safety and convenience when traveling, follow these guidelines:

- Safeguard your data before you leave on a trip by performing a backup onto diskettes, tape media, or another computer.
- Take an extra backup copy of the data with you.
- Remove the diskette from the diskette drive.
- Disconnect the AC Adapter from the computer. Take the AC Adapter or an extra fully charged battery pack with you.
- Disconnect external equipment, including cables, from the computer.
- Hand-carry the computer in the slipcase. Do not check it with your luggage.
- Do not close objects between the keyboard and display.

**IMPORTANT:** There are three types of airport security devices: X-ray machines (the device you set your bags on), magnetic detectors (the device you walk through), and security magnetic wands (the handheld device used by security personnel). You can send your computer and diskettes through airport X-ray machines. However, Compaq recommends that you do not send your computer and diskettes through airport magnetic detectors or expose them to security magnetic wands.

- Check with the airline if you plan to use the computer on the plane. In-flight computer use is at the discretion of the airline.

Before traveling internationally with the computer:

- Check local customs regulations.
- In accordance with the guidelines outlined in Appendix D of this guide, purchase a power cord from a Compaq authorized dealer, reseller, or service provider in the country where you will be using the computer. These power cords are designed to meet the voltage and frequency requirements of each country.



**WARNING:** To reduce the risk of electrical shock, fire, or damage to the equipment, do not use the converter kits sold for appliances to power the computer.

---



- Make sure you have the correct modem and cable for the country you'll be visiting. Telephone line standards and modem protocols differ from country to country.

## Shipping Guidelines

Should you need to ship the computer, follow these guidelines:

- Safeguard your data before shipping by backing it up onto diskettes or tape media. Be sure that diskettes or tapes are not exposed to electrical or magnetic impulses while stored or in transit.
- Remove the diskette from the diskette drive.
- Remove all PC Cards from the PC Card slots.
- Turn off the computer and external devices.
- Close the computer.
- Disconnect external equipment from the computer.
- Pack the computer and external devices in their original packing boxes or similar packaging with sufficient packing material to protect them.

# chapter 14

## COMPUTER SETUP AND DIAGNOSTICS

The Computer Setup and diagnostic utilities described in this chapter allow you to view, set or change system configurations and diagnose and communicate system problems. These utilities should be used in the following instances:

- To change factory default settings and to set or change the system configuration, which is sometimes necessary when you add or remove optional equipment.
- When a system configuration error is detected during the Power-On Self-Test (POST).
- To determine information about the operating environment of the system.

# Setup and Diagnostics Utilities

Computer Setup gives you an overview of the computer's hardware configuration. This utility also allows you to set custom features, such as security options, power conservation levels, and startup preferences. Diagnostics helps you diagnose and troubleshoot computer problems. Both are located in Compaq Utilities and help you communicate computer problems effectively with authorized Compaq dealers or service providers.

## Accessing Computer Setup

If you are using Microsoft Windows 95, your computer automatically recognizes and configures the system for new devices. But, if you have a configuration problem, or want to view or reset configuration settings, you can use Computer Setup.

To access Computer Setup (or Diagnostics) on the Compaq Utilities menu, follow these steps:

1. Restart the computer by clicking Shut Down on the Windows Start menu. (Or turn on power.)
2. Press **F10** as soon as the cursor appears in the upper right corner of the screen

**IMPORTANT:** The cursor is displayed on the screen for about two seconds. If you do not press **F10** during this time, you must restart the computer and try again.

## Computer Setup Options

Computer Setup provides two ways to view the computer's configuration: by type or by connection. The default setting is to view devices by type. Devices accessible by type, include:

- **System features:** security, power, boot management
- **Communication:** port, modem, other communication devices
- **Storage:** storage-related devices, such as hard drive or diskette drive
- **Input Devices:** keyboard, mouse or other input devices
- **Audio:** sound properties and audio device settings
- **Video:** monitor timeouts and video device resources
- **Other Devices:** settings or devices that could not be categorized

## Accessing Diagnostics Utilities

### Diagnostics for Windows

Diagnostics for Windows is a utility that inspects computer hardware, internal system temperature, and the SMART hard drive, then displays a prefailure warning message upon detecting a system temperature or hard drive fault.

If you are running Windows 95, access Compaq Diagnostics for Windows as follows:

1. Double-click My Computer.
2. Double-click Control Panel.
3. Double-click Compaq Diagnostics.

If you are running Windows NT, access Windows NT Diagnostics by clicking Start, Programs, Administrative tools, then Windows NT Diagnostics.

## Compaq Diagnostics

Use the Compaq Diagnostics utility to identify and test all system devices. To run this utility, restart your computer. When the blinking cursor appears in the top right corner of the screen, press **F10**. Select the Test option to run Compaq Diagnostics.

The Compaq Utilities menu will appear immediately after the computer has been turned on and the Power-On Self-Test (POST) has been completed. Because this menu is accessed before the operating system takes effect, it is available to all computer users, no matter which operating system they typically use (for example, MS-DOS, Windows, or OS/2).

## Running Computer Checkup (TEST)

Computer Checkup (TEST) is a utility that determines if the various computer devices are recognized by the system and functioning properly. Running Computer Checkup is optional, but advisable, after installing or connecting a new device.

You can display, print, or save the information generated by Computer Checkup. Your Compaq authorized dealer, reseller, or service provider may ask you to run this utility to assist in analyzing the system. This information allows the service provider to reproduce the same environment on another computer for testing.

It is also recommended that you run Computer Checkup and have the printed report available before placing a call to Compaq Customer Support.

To run Computer Checkup, follow these steps:

1. Connect the AC Adapter and use it with the computer during these procedures. (A low-battery condition could initiate Hibernation and interrupt the program.)
2. Turn on only the external devices that you want to test. Connect the printer if you want to use it to log error messages.
3. Turn on or restart the computer by clicking Shut Down on the Windows Start menu.

4. As soon as the cursor (a white box) is displayed in the upper-right corner of the screen, press **F10**.

**IMPORTANT:** The cursor is displayed on the screen for about two seconds. If you do not press **F10** during this time, you must restart the computer and try again.

5. If prompted, select a language.

The Compaq Utilities menu is displayed.

6. Select Computer Checkup (TEST). A test option menu is displayed.

7. Select the View Device List option. A list of the installed Compaq devices is displayed.

8. Verify that Computer Checkup correctly detected the devices installed.

**NOTE:** Devices from other manufacturers may not be detected or may be reported inaccurately.

- If the list is correct, select OK. The test option menu is displayed again. Go to step 9.
- If the list is incorrect, ensure that any new devices are installed properly. If you do not find an installation problem, call your Compaq authorized service provider.

9. Select one of the following from the test option menu:

- **Quick Check Diagnostics**

Runs a quick, general test on each device with a minimal number of prompts. If errors occur, they are displayed when the testing is complete.

- **Automatic Diagnostics**

Runs unattended, maximum testing of each device with minimal prompts. You can choose how many times to run the tests, to stop on errors, or to print or file a log of errors.

- **Prompted Diagnostics**

Allows maximum control over the device testing process. You can choose attended or unattended testing, decide to stop on errors, or choose to print or file a log of errors.

10. Follow the instructions on the screen as the devices are tested. When the testing is complete, the test option menu is displayed again.

**NOTE:** When you run Computer Checkup, record any error message numbers and have them available when you contact your Compaq authorized reseller or service provider for assistance.

11. Exit to the Compaq Utilities menu.

## Running the View System Information (Inspect Utility)

The View System Information (INSPECT) utility provides information about the system once it has been configured. This utility provides the following information about the system operating environment:

- Contents of the operating system startup files
- Current memory configuration
- ROM versions
- Type of processor
- Diskette and hard drives
- Active printer and communications interfaces
- Modem
- Graphics/video
- Windows *WIN.INI* file
- Windows *SYSTEM.INI* file

You can display, print, or save the information. Your Compaq authorized reseller or service provider may ask you to run this utility to assist in analyzing the system. This information allows the service provider to reproduce the same environment on another computer for testing. It is recommended that you run View System Information and have the printed results available before placing a call to Compaq Customer Support.

**NOTE:** This utility is not available from Windows. It must be accessed from the Compaq Utilities menu. However, in Windows, the Compaq Diagnostics utility provides similar information about the computer. To run Compaq Diagnostics for Windows, click the Windows Start menu, then click Settings, then click Control Panel, then double-click the Compaq Diagnostics icon.

To run View System Information (INSPECT), follow these steps:

1. Turn on or restart the computer by pressing the power button.
2. As soon as the cursor is displayed in the upper-right corner of the screen, press **F10**.

**IMPORTANT:** The cursor is displayed on the screen for about two seconds. If you do not press **F10** during this time, you must restart the computer and try again.

3. If prompted, select the desired language. The Compaq Utilities menu is displayed.
4. Select View System Information (INSPECT).



# chapter 15

## TROUBLESHOOTING

This chapter provides information on how to identify and correct some common hardware, memory, and software problems. It also explains several types of common messages that can be displayed on the screen. Troubleshooting information is provided on the following pages for:

- Battery
- Diskettes/diskette drive
- Hard drive
- Hardware installation
- Keyboard/numeric keypad
- Memory
- Monitor
- PC Cards
- Pointing device
- Power
- Printer
- Screen
- Software applications
- Sound problems

### Checklist

If you encounter some minor problem with your computer or software application, go through the following checklist for possible solutions before running the diagnostic utilities:

- Is the computer connected to an external power source, or does it have a fully charged battery pack installed?
- Is the computer turned on and the power/suspend indicator light on?
- Are all cables connected properly and securely?
- Have you installed printer drivers for each application?

- Did the diskette drive contain a non-bootable diskette when you turned on the computer?

If correcting the items on this checklist does not solve the problem, you may wish to run the Computer Checkup utility. Refer to Chapter 14, “Diagnostics,” for more information.

## Interpreting Messages on the Screen

Many times a message or prompt is displayed on the screen. However, a message does not necessarily mean that an error condition exists. It may be nothing more than an information message about what the computer is doing or a prompt reminding you to enter information or press a key. The following list shows typical examples of information messages:

- A number might be displayed.

The number indicates the amount of memory in the computer.

- Backing up files to drive A:

This message indicates that MS-DOS is backing up a file to the diskette in drive A.

- Exit this utility.

This message prompts you to exit a utility by following the additional instructions on the screen.

- A:> or A:

This prompt indicates that you are working from drive A.

- C:> or C:

This prompt indicates that you are working from the hard drive.

For error messages during the Power-On Self-Test (POST), see Appendix B, “POST Error Messages.”

# Solving Minor Problems

While your computer is configured just for you, problems you encounter while working may not be unique. Eliminating the typical problems described in this section may save you time and money. If you have a problem with your computer, consider the causes and possible solutions outlined in the following tables.

If the problem appears related to a software application, also check the documentation provided with the software. You may discover something you can resolve easily yourself. If the condition persists, contact your Compaq authorized service provider or Compaq Customer Support.

## Solving Battery Problems

Some common causes and solutions for battery problems are listed in the following table. The “Solving Power Problems” section in this chapter also may be helpful to you.

---

<b>Battery Problems and Solutions</b>		
<b>Problem</b>	<b>Possible Cause</b>	<b>Solution</b>
Computer won't turn on when battery packs are inserted and AC Adapter is unplugged.	Battery packs are discharged.	Connect the computer to an external power source and charge the battery pack(s).
		Replace the battery pack(s) with a fully charged battery pack(s).
Computer beeped and battery indicator is blinking.	Battery charge is low or computer has entered a low-battery condition.	Save any open files and do one of the following: <ul style="list-style-type: none"><li>■ Connect the computer to an external power source, then charge the battery pack(s).</li><li>■ Initiate Hibernation (press <b>Fn+ Suspend</b>) to halt the battery drain until you can find another power source or charge the battery pack(s).</li></ul>

---



## Battery Problems and Solutions *Continued*

<b>Problem</b>	<b>Possible Cause</b>	<b>Solution</b>
Battery charge indicator blinks for low-battery condition, but computer didn't beep.	Low-battery beeps are turned off.	Click the Battery Conservation tab on the Power icon in the Control Panel and enable low-battery warning beeps.
	Speaker volume is turned down.	Press <b>Fn+F5</b> (using arrow keys) to increase speaker volume.
Battery charge indicator doesn't turn on.	Battery packs are already charged.	No action is necessary.
Battery pack won't fast charge.	Battery packs were exposed to temperature extremes.	Allow time for the battery pack(s) to return to room temperature.
	Battery packs are at the end of their life.	Replace the battery pack(s).
	Battery packs are already fully charged.	Use the battery pack(s) without attempting to fast charge.
Every time the computer is turned on, I have to set the date and time.	Real-time clock battery is at the end of its life.	Call your Compaq authorized service provider to replace the real-time clock battery.

*Continued*

## Battery Problems and Solutions *Continued*

Problem	Possible Cause	Solution
Battery charge doesn't last as long as expected.	Battery packs are being exposed to high temperatures.	Keep computer at a cooler temperature and recharge battery pack(s).
	Battery packs are being exposed to cold temperatures.	Put computer in a warmer place and recharge battery pack(s).
	Battery packs have partially self-discharged.	Recharge the battery pack(s).
	Battery conservation is disabled or set to "None."	Press <b>Fn+F7</b> to set a new battery conservation level.
	An external device (such as a CD-ROM or PC Card) is draining the battery.	Turn off or remove the external device when it is not in use.
Battery packs are warm to the touch after charging.	Warming occurs due to charging.	No action is required.

**NOTE:** Store the battery pack in a cool, dry place when not in use. High temperatures reduce the life of the battery pack and cause it to lose its charge more quickly. If you are storing the battery for less than one month, the recommended storage temperature is 32°F to 122°F (0°C to 50°C); for no more than three months, the recommended temperature is 32°F to 104°F (0°C to 40°C); for an unlimited time, the recommended temperature is 32°F to 86°F (0°C to 30°C).

## Solving Diskette/Diskette Drive Problems

Some common causes and solutions for diskette/diskette drive problems are listed in the following table:

<b>Diskette/Diskette Drive Problems and Solutions</b>		
<b>Problem</b>	<b>Possible Cause</b>	<b>Solution</b>
Diskette drive cannot write to a diskette.	Diskette is write-protected.	Disable the write-protect feature or use a diskette that is not write-protected.
	Computer is writing to the wrong drive.	Check the drive letter in the path statement.
	Diskette drive has been disabled.	Enable diskette drive through the Device Manager in the Systems icon on the Control Panel or through <b>F10</b> setup.
	Diskette is not formatted.	Format the diskette.
Diskette drive cannot read a diskette.	Wrong type of diskette is being used.	Use the type of diskette required by the drive.
	Diskette has a bad sector.	Copy files to hard drive or another diskette. Reformat the bad diskette.
	Diskette drive has been disabled.	Enable diskette drive via the Device Manager in the Systems icon on the Control Panel or through <b>F10</b> setup.
	Diskette is not formatted.	Format the diskette.

## Solving Hard Drive Problems

Some common causes and solutions for hard drive problems are listed in the following table. Chapter 14, “Diagnostics,” also may help you solve hard drive problems.



**CAUTION:** Remove or install the hard drive only when the computer is off, unplugged, and the battery pack is removed. Do not remove or install a hard drive while the computer is on, in Suspend, or in Hibernation.

### Hard Drive Problems and Solutions

Problem	Possible Cause	Solution
Reading the hard drive takes an unusually long time after restarting the computer.	System entered Hibernation due to low-battery condition and is now exiting from it.	Give the system time to restore the previously saved data to its exact state before Hibernation.
Hard drive error occurs.	Hard drive has bad sectors or has failed.	If you are running Windows 95, run ScanDisk utility; check the box “Automatically fix.” If you are running Windows NT, go to the system prompt and type chkdsk. The computer will automatically scan for errors.
		Reformat the hard drive. Contact your Compaq authorized service provider.
Newly installed hard drive does not work.	Hard drive is not seated properly.	Turn off and unplug the computer. Remove the battery pack. Remove and reinstall the hard drive.
	Hard drive was removed and replaced while computer was on, in Suspend, or in Hibernation.	Turn off the computer; then turn it on again. Before removing the hard drive, make sure computer is off, unplugged, and the battery pack is removed.



**CAUTION:** You should maintain an up-to-date backup of your hard drive at all times in case of errors or failures.



## Solving Hardware Installation Problems

Some common causes and solutions for hardware installation problems are listed in the following table.

<b>Hardware Installation Problems and Solutions</b>		
<b>Problem</b>	<b>Possible Cause</b>	<b>Solution</b>
New device is not recognized as part of the computer system.	Suspend was not initiated before device was connected.	Initiate Suspend, connect the device, and then exit Suspend.
	The system did not automatically configure the new device.	Check the documentation that came with the new device to determine if any device drivers are necessary. If so, install the correct device drivers.  To view the status, change drivers, or change the configuration, go to the Device Manager in the Systems icon on the Control Panel. Click the plus sign next to the type of hardware, then double-click the hardware to view the device configuration.
	Cables of new external device are loose or power cables are unplugged.	Ensure that all cables are properly and securely connected.
	Power switch of new external device is not turned on.	Place the computer in Suspend by pressing the suspend button. Turn on the new external device. Press the suspend button again to exit Suspend. This enables the system to recognize the device.
	Device is not seated properly.	Turn off the computer and reinsert the device.

## Solving Keyboard and Embedded Numeric Keypad Problems

Some common causes and solutions for keyboard and embedded numeric keypad problems are listed in the following table.

---

Solving Keyboard and Numeric Keypad Problems		
Problem	Probable Cause	Solution
Embedded numeric keypad on the computer keyboard is disabled.	Num Lock function is not turned on.	Press <b>Fn+End/NumLk</b> to enable the Num Lock function and embedded numeric keypad.
External keyboard does not work.	Keyboard may not be securely connected or may be connected to the wrong external connector.	Ensure that the external keyboard is securely connected to the external keyboard connector.
Keyboard and pointing device are locked.	You initiated QuickLock.	Enter your power-on password to exit QuickLock.  <b>NOTE:</b> If Num Lock is on (the embedded numeric keypad is active), hold down the <b>Fn</b> key while typing to enter a non-numeric password; pressing <b>Fn</b> temporarily toggles Num Lock off. Press <b>Fn+Shift</b> to type any uppercase characters.

---

## Solving Memory Problems

Some common causes and solutions for memory problems are listed in the following table.

<b>Memory Problems and Solutions</b>		
<b>Problem</b>	<b>Possible Cause</b>	<b>Solution</b>
Memory count during Power-On Self-Test (POST) is incorrect.	Optional memory expansion boards are installed incorrectly.	Ensure that the memory expansion boards have been installed correctly.
“Out of Memory” message is displayed on the screen, or insufficient memory error occurs during operation.	System ran out of memory for the application.	Check the application documentation for memory requirements and add more memory if needed.  Install additional memory.
	Too many terminate-and-stay resident (TSR) applications are running at the same time.	Disable any TSR applications you do not need.

## Running the Monitor Self-Test

You can perform a “self-test” on an external VGA color or monochrome monitor by disconnecting the monitor from the computer. To do so, complete the following steps:

1. Turn off the monitor.
2. Turn off the computer.
3. Disconnect the monitor signal cable from the computer.
4. Turn on the monitor and allow it to warm up for one minute.
5. The screen should be white. A narrow black border may also appear on the left and right sides of the monitor screen. Either condition indicates that the monitor is working properly.

## Solving PC Card Problems

Some common causes and solutions for PC Card problems are listed in the following table.

<b>PC Card Problems and Solutions</b>		
<b>Problem</b>	<b>Possible Cause</b>	<b>Solution</b>
The computer does not beep when a PC Card is inserted.	Card is not inserted properly.	Ensure the card is inserted correctly. Remove and reinsert the card. Insert the card gently to avoid damaging the pins.
	Card or card driver is not compatible with your computer.	Refer to the documentation that came with your PC Card. Contact your Compaq authorized dealer, reseller, or service provider for a list of PC Cards supported by Compaq. See Chapter 10, "Connecting External Devices," to see the Compaq PC Card logo signifying Compaq-supported cards.
PC Card does not work.	Card is not fully inserted into the slot or is not inserted properly.	Ensure the card is inserted in the correct orientation, or remove and reinsert.

*Continued*

<b>Problem</b>	<b>Possible Cause</b>	<b>Solution</b>
Fax/modem PC Card does not work.	You are trying to access the card using the wrong COM port.	<p>If you are running Windows 95, click the modem icon in Device Manager, then click Properties to select another COM port for the modem/fax card.</p> <p>If you are running Windows NT, from the Windows desktop, double-click My Computer. Double-click Control Panel. Then double-click Ports to select another COM port for the modem/fax card.</p>
	Telephone cord is not plugged in all the way.	Check and secure telephone cord connection.
Network PC Card does not work.	Network driver is not set up properly or resources are not available for this configuration.	<p>If you are running Windows 95, use the Network Neighborhood icon to identify information about your network card and setup. Then use the Add New Hardware wizard to install the correct card driver.</p> <p>If you are running Windows NT, double-click My Computer. Double-click Control Panel. Then double-click Networks to identify information about your network card and to install the correct card driver.</p>
Storage memory card does not work.	Card is not compatible.	Contact Compaq Customer Support or a Compaq authorized service provider for a list of PC Cards tested successfully in Compaq computers. Look for the Compaq PC Card Solution Logo on PC Card packaging.

## Solving Power Problems

Some common causes and solutions for power problems are listed in the following table. The “Solving Battery Problems” section in this chapter also may be helpful.

Power Problems and Solutions		
Problem	Possible Cause	Solution
Computer won't turn on when battery packs are not inserted.	Computer is not connected to a power source.	Insert battery pack(s) or connect to AC Adapter, Automobile Adapter, or convenience base.
	Cables to the external power source are unplugged.	Ensure that cables connecting computer and external power source are plugged in properly.
Computer won't turn on when plugged in and battery packs are inserted.	Battery pack(s) may be defective.	Remove battery pack(s), insert another battery pack, and turn on computer again.
Computer beeped and battery charge indicator is blinking.	Computer has entered a low-battery condition.	Immediately save any open files. Then do one of the following: <ul style="list-style-type: none"><li>■ Connect the computer to an external power source to charge the battery pack(s).</li><li>■ Initiate Hibernation to completely halt the drain on the battery until you can charge the battery pack(s) or find another power source.</li></ul>
Computer turned off while it was left unattended and power indicator is off.	System initiated Hibernation due to a low-battery condition.	Replace the battery pack(s) with fully charged batteries or connect the computer to an external power source. Then turn on the computer.

## Solving Printer Problems

Some common causes and solutions for printer problems are listed in the following table.

<b>Printer Problems and Solutions</b>		
<b>Problem</b>	<b>Possible Cause</b>	<b>Solution</b>
Printer won't turn on.	The cables may not be connected properly, or the printer is unplugged.	Ensure that the cables are properly connected and that the AC Adapter is connected to the electrical outlet.
Printer won't print.	Printing device is not selected.	Select the printer in Windows Printer Setup.
	Printer is not turned on.	Turn on the printer.
	Printer is not online.	Set the printer to online.
	Printer driver for your application is not installed.	Double-click the Printers icon on the Control Panel on the Start menu. Double-click Add Printer and follow the instructions on the screen.
	Printer that is set up for a network is not connected to the network.	Connect the printer to the network.
	Printer cable is too long, unshielded, or defective.	Replace the cable.
Printer is offline.	Paper tray is empty.	Fill the paper tray with paper. Set the printer to online.
Printer prints garbled information.	Correct printer driver is not installed.	Double-click the Printers icon on the Control Panel on the Start menu. Follow the instructions on the screen.
	Cable is not connected properly.	Ensure that the printer cable is connected properly to the computer or Mobile CD Expansion Unit (MCD).

If you experience problems printing, run a printer self-test. Refer to the documentation provided with your printer for instructions. If the self-test fails, it is a printer-specific problem. The printing section of your application software documentation may also be helpful.

## Solving Display Screen Problems

Some common causes and solutions for display screen problems are listed in the following table.

<b>Display Screen Problems and Solutions</b>		
<b>Problem</b>	<b>Possible Cause</b>	<b>Solution</b>
Characters are dim.	Brightness/contrast controls not properly set.	Press hotkeys <b>Fn+F9</b> to adjust contract. On models with a passive matrix display, you can also press <b>Fn+F10</b> to adjust brightness.
	Computer screen is in direct light.	Tilt display or move computer.
Screen is blank.	You may have a screen blanking utility installed.	Press any key and/or enter your password.
	Brightness/contrast needs adjusting.	Press <b>Fn+F10</b> to adjust brightness. On models with passive matrix displays, you can also press <b>Fn+F9</b> to adjust contrast.
	Screen has overheated.	If computer is in direct sunlight, move it and allow it to cool off.
Screen is blank and the power/suspend indicator is blinking.	System is in Suspend.	Press the suspend button to exit Suspend.
	System is in Suspend and QuickLock and/or QuickBlank has initiated.	Exit Suspend and enter your power-on password.

*Continued*



## Display Screen Problems and Solutions *Continued*

Problem	Possible Cause	Solution
Screen is blank, the power/suspend indicator is blinking, and the battery charge indicator is blinking.	System has entered a low-battery condition.	<p>If available, immediately connect the computer to an external power source or replace the battery pack.</p> <hr/> <p>If an external power source is not available, initiate Hibernation by pressing <b>Fn +</b> the power button, or let the computer automatically go into Hibernation. The computer has not completed Hibernation until all lights are off.</p> <hr/> <p>If Hibernation has not been disabled, you can let the computer initiate Hibernation. Do not interfere with the hibernation process. Once the computer has turned off, replace the battery pack or connect the computer to another power source. Then turn the computer back on.</p>
Computer screen is blank and the screen on an external monitor displays information.	External monitor was turned on before the computer was turned on.	Press the <b>Fn+F4</b> hotkeys to display information on the computer display; press the hotkeys again to display information simultaneously.
Screen is blank and keyboard is locked.	QuickLock and QuickBlank were initiated.	Type your power-on password to unlock the keyboard and pointing device and return information to the screen.
Computer screen and external monitor won't display information simultaneously.	External monitor was connected after the computer was turned on.	<p>Turn the computer off and reconnect the external monitor. Turn the external monitor on, then turn the computer on.</p> <p>Press the <b>Fn+F4</b> hotkeys to toggle through the three display options.</p>

**NOTE:** If you are using an external monitor and simultaneously displaying an image on the computer display and the external monitor, the image on the external monitor may not fill the screen.

## Solving Software Application Problems

Most software application or installation problems occur because of one or more of the following conditions:

- Application was not installed correctly.
- Memory was not allocated correctly.
- Conflict exists between applications.

---

### Software Application Problems and Solutions

---

Problem	Probable Cause	Solution
Cannot use an application.	The application has not been added to the PATH statement.	Using Windows Notepad, add the application directory with the full path name to the <i>AUTOEXEC.BAT</i> file.
Insufficient memory to run application.	System ran out of memory for the application.	Check the application documentation for memory requirements. Install additional memory.

## Solving Sound Problems

Some common causes and solutions for sound problems are listed in the following table.

---

### Sound Problems and Solutions

---

Problem	Possible Cause	Solution
Computer beeps after you turn it on.	This is normal; it indicates successful completion of the POST.	No action is required.
Computer does not beep after the Power-On Self-Test (POST).	Computer volume is turned down.	Use the <b>Fn+F5</b> hotkeys and the arrow keys to turn up the volume.

## Solving Pointing Device Problems

Some common causes and solutions for trackball and mouse problems are listed in the following table.



<b>Pointing Device Problems and Solutions</b>		
<b>Problem</b>	<b>Possible Cause</b>	<b>Solution</b>
External serial mouse does not work	The computer was not shut down before connecting the device.	Shut down the computer. Connect the device. Reboot.
	Incorrect or no device driver is installed.	To view the pointing device driver, access the Start menu via the keyboard by pressing <b>Ctrl+Esc</b> . Use the arrow keys to get to Settings, then Control Panel, and press <b>Enter</b> . Use arrow keys to select the System icon and press <b>Enter</b> . Use the arrow keys to access Device Manager. Use the <b>Tab</b> key to get to the computer icon and the arrow keys to select the mouse. Press the right arrow to access the hardware. Tab to the Properties button and press the Space bar. Use the right arrow to get to the Driver tab and follow the instructions on the screen.

*Continued*

<b>Problem</b>	<b>Possible Cause</b>	<b>Solution</b>
Touchpad or trackball does not work.	An external PS/2 mouse or other pointing device is connected to the computer, and the system disabled the touchpad or trackball.	Press the suspend button to place the computer in Suspend. Disconnect the mouse or other pointing device, then press the suspend button again to exit Suspend.  Click Shut Down on the Start menu to turn off the computer. Disconnect the mouse or other pointing device, then press the power button to reboot.
Device driver is loaded but pointing device doesn't work.	Wrong pointing device is selected.	If you are running Windows 95, use the keyboard to select Automatically detect installed hardware in the Add New Hardware wizard. Then click the mouse icon in the selection box and choose the correct mouse hardware.  If you are running Windows NT, press F6. Then use the arrow keys to highlight My Computer, and press Enter. Use the arrow keys to highlight Control Panel, and press Enter. Use the arrow keys to highlight Mouse, and press Enter. Select the correct mouse hardware, and press Enter.
Cursor skips or moves abnormally when using a pointing device.	The pointing device needs cleaning.	Clean the pointing device. Refer to Chapter 4, "Working with Pointing Devices," for instructions on cleaning the touchpad. Or see "Cleaning the Trackball" in this chapter.

## Cleaning the Trackball

Operate the trackball with clean hands. Under normal conditions, you only need to wipe the computer case and trackball with a dry soft cloth. If the cursor begins to skip or move abnormally when using the trackball, follow these steps to remove and clean it:

1. Turn off the computer by pressing Shut Down from the Start menu.
2. Remove the battery packs and disconnect the AC Adapter if it is plugged in.
3. Loosen the retaining ring by placing a pen in the hole  on the ring and turning it  about 20 degrees counterclockwise.

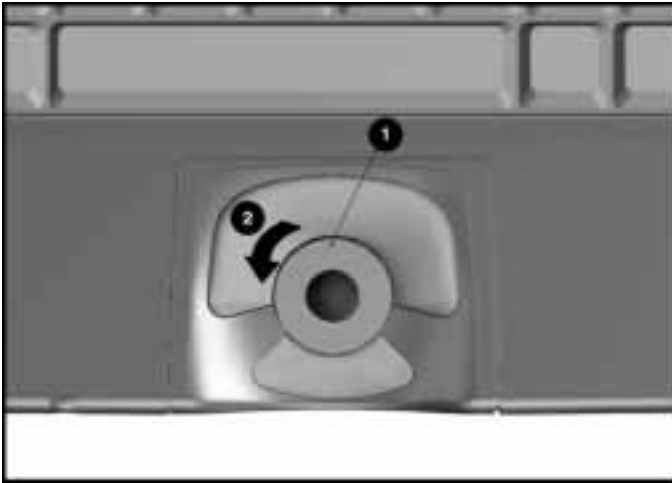

*Removing the Retaining Ring and the Trackball*

4. Remove the retaining ring and ball from the housing.
5. Gently clean the ball with tap water or isopropyl alcohol. Then rinse with water and dry it with a lint-free cloth.





**CAUTION:** To avoid damage to the trackball, do not use an abrasive cleaner on it.

---

6. Before replacing the ball, clean the trackball assembly. Refer to the following section, “Cleaning Inside the Trackball Assembly.”

## Cleaning Inside the Trackball Assembly

To remove dust and buildup on the inside surfaces of the trackball:

1. Turn off the computer. Remove battery packs. Disconnect external devices. Remove the trackball.
2. Remove any large particles of debris that have fallen into the trackball housing.
3. Dip a cotton swab in isopropyl alcohol and squeeze off the excess liquid.
4. Carefully wipe inside the cage to remove residue from the surfaces. Clean the ball bearings  by rubbing with the swab. Do not attempt to remove the bearings. Do not use alcohol on the sensor window . Instead, gently wipe the sensor window with a soft, dry, lint-free cloth until all debris is removed.

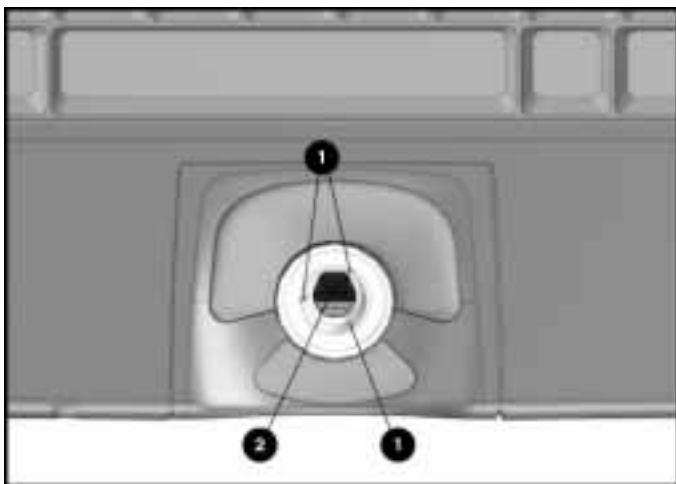

*Cleaning Inside the Trackball*



**CAUTION:** To avoid damage to the computer, do not use alcohol on the sensor window.

---

5. Allow the parts to air dry before reassembling.
6. Replace the ball in the trackball cage.

7. Replace the retaining ring by aligning the notches. Then use the trackball tool to turn the retaining ring clockwise until it snaps into place.
8. Replace the battery pack and reconnect the AC Adapter if necessary.

## **Servicing the Computer**

To get help from Compaq Customer Support or to find a Compaq authorized reseller or service provider location, call one of the numbers in the worldwide telephone numbers list in Appendix A, "Compaq Customer Support."

Your Compaq authorized reseller or service provider is available to answer your questions, install optional equipment, and service your computer.

If you take the computer in for service, remember to provide the power-on password or, if possible, disable the password in Passwords Properties prior to delivery to the service provider.

## Preparing for a Call to Customer Support

If your efforts to solve the problem yourself have not been successful, a call to Compaq Customer Support or a Compaq authorized reseller or service provider may be necessary. (To get help from Compaq Customer Support or to find a Compaq authorized reseller or service provider location, call one of the numbers in the worldwide telephone numbers list in Appendix A, “Compaq Customer Support.”)

Before you place a call, run Compaq Diagnostics and print out the hard copy results for reference, if possible.

You should have the following information ready so that the customer support representative can provide you with the fastest possible solution when you call.

- Product name
- Product model number
- Product serial number (located on the bottom of the computer)
- Purchase date
- Conditions under which the problem occurred
- Any error messages that have occurred
- Hardware configuration
- Type of printer connected
- Hardware/software you are using
- Printed results from running Compaq Diagnostics for Windows



# chapter 16

## INTELLIGENT MANAGEABILITY

### Access to Intelligent Manageability

Intelligent Manageability (IM) is a set of software features that work in the background of your computer. You will know IM is installed on your computer by the icon, a lower-case “i” on the right end of the taskbar. To view IM features on a local machine, follow these steps:

1. Click Start.
2. Click Settings.
3. Click Control Panel.
4. Double-click the Compaq Insight Personal Edition icon.

### Features and Benefits

Intelligent Manageability combines innovative hardware technology with Enterprise Management and PC LAN management solutions from Compaq and other leading vendors to make Compaq portable computers easier to inventory, troubleshoot, and protect.

Enterprise Management works on a geographically distributed network containing a wide range of network devices such as computers, bridges, routers, gateways, and modems.

# Asset Management

AssetControl is asset management software designed to cut the time and cost of conducting a physical inventory of personal computers, key components, and monitors. AssetControl is preinstalled on portable computers, key components, and monitors that support the Video Electronics Standards Association Data Display Channel (VESA DDC) and Extended Display Identification Data (EDID) standards.

AssetControl features make it easy and inexpensive to maintain an accurate, up-to-date inventory. Detailed inventory information, including manufacturer, model, serial number, asset tag, and ROM revision level can be viewed, printed, or saved electronically using Compaq Insight Personal Edition.

Compaq Insight Personal Edition refers to Intelligent Manageability software that diagnoses portable computer hardware, monitors the internal system temperature and hard drive, and then displays a prefailure warning message on detecting a system temperature or hard drive fault.

# Fault Management

Fault management is a utility designed to help prevent the loss of critical data using the following features:

- IntelliSafe hard drive—Constantly monitors hard drive activity to predict failures before they occur.
- Temperature sensing—Hardware and software that tracks the internal temperature of the computer and displays a warning message when the normal range is exceeded.

Compaq Insight Personal Edition displays a popup message to notify you when a hard drive or system temperature fault is detected. If the computer is connected to a network, asset information can also be seen by using Compaq Insight Manager.

# Security Management

The security management utility provides a set of security features to protect the computer and data from unauthorized access:

- **Passwords**—Prevents unauthorized access to information stored on the computer or network.
- **Drive security**—Prevents starting the computer from the diskette drive and reading information from the diskette drive.

**Device disabling**—Prevents unauthorized data transfer over fax/modems, serial ports, parallel ports, and infrared ports.



# appendix A

## COMPAQ CUSTOMER SUPPORT

### Worldwide Telephone Numbers

Locate your geographical area in the following table and use one of the telephone numbers for Compaq assistance.

**General Information Numbers**—Product information, technical assistance, and the location of your nearest Compaq authorized dealer, reseller, or service provider.

**Technical Support Numbers**—Hardware technical support in analyzing system configuration and diagnostic problems or troubleshooting.

**Customer Support Numbers**—Information on service and support programs including warranty, product catalogs, and white papers.

**PaqFax Numbers**—Automatic facsimile response system for technical and product-specific information that is transmitted to any fax machine. PaqFax is available 24 hours a day.

**NOTE:** Telephone numbers are subject to change without notice.

\* Indicates toll-free domestic numbers.

---

## Worldwide Telephone Numbers

---

Location	Country Code	Telephone Number
<b>Argentina</b>		
General Information	+54	-1-796-1616
Technical Support	+54	-1-796-1717
<b>Australia</b>		
General Information		61-2-9911-1999
Technical Support		61-2-9911-1955
PaqFax		61-2-9911-1982
<b>Austria</b>		
General Information*		0222/8 78-16-16
Technical Support*		0222/8 78-16-16
Order Software Backup	+31	-55-38-43-39
<b>Belgium / Luxembourg</b>		
Compaq Care Center	Bel Lux	0903-99036 (45 BFr/min.) 089/89.232
General Fax	+32	(0)2/725 22 13
Infoline (resellers, brochures)	+32	(0)2/716 96 96
QuickLine (BBS)	+32	(0)2/716 95 92
Order Software Backup	+32	(0)2/716 96 78
Order Software Backup by Fax	+32	(0)2/716 96 79
<b>Brazil</b>		
General Information	+55	-11-246-7866
<b>Canada</b>		
General Information		1-905-707-1715
Technical Support*		1-800-OKCOMPAQ (1-800-652-6672)
Customer Support*		1-800-263-5868
Order Software Backup*		1-800-952-7689
Battery Pack Recycling*		1-800-263-5868
<b>Caribbean</b>		
General Information		1-281-514-4220
Technical Support		1-281-518-2200

*Continued*

**Worldwide Telephone Numbers** Continued

<b>Location</b>	<b>Country Code</b>	<b>Telephone Number</b>
<b>Chile</b>		
General Information	+56	-2-274-1911
Technical Support	+56	-2-274-3007
<b>China</b>		
General Information	+86	-10-6831-3399
Technical Support	+86	-10-6834-6721
<b>Colombia</b>		
General Information	+57	-1-312-0201
Technical Support	+57	-1-345-0266
<b>Czech Republic</b>		
General Information	+420	-2-232-8772
Technical Support	+420	-2-232-8772
<b>Denmark</b>		
General Information	+45	-45-90-45-90
Technical Support	+45	-45-90-45-45
<b>Finland</b>		
General Information	+358	-0-615 599
Technical Support*		0203-206 720
QuickLine (BBS)	+358	-0-6155 9870
<b>France</b>		
General Information	+33	-1-41-33-41-33
Technical Support	+33	-1-41-33-44-55
<b>Germany</b>		
		0,48 DM/min.
Hotline		0180/5 21 21 11
Hotline Fax		0180/5 21 21 17
Infoline		0180/3 22 12 21
Infoline Fax		0180/3 22 12 20
QuickLine		0180/5 21 21 18
FaxPaq		0180/5 21 21 19
Order Software Backup*		0130/81 10 81

*Continued*

**Worldwide Telephone Numbers** Continued

<b>Location</b>	<b>Country Code</b>	<b>Telephone Number</b>
<b>Hong Kong</b>		
General Information		852-28681382
Technical Support		852-90116633
PaqFax		852-28671648
<b>Hungary</b>		
General Information	+36	-1-457-3600
Technical Support	+36	-1-457-3682
<b>India</b>		
General Information		91-80-559-6023
PaqFax		91-80-559-8989
BBS		91-80-559-8900
<b>Israel</b>		
General Information	+972	-3-6363-444
Technical Support	+972	-3-6363-444
PaqFax	+972	-3-6396-601
<b>Italy</b>		
General Information	+39	-2-57-59-03-00
Technical Support	+39	-2-57-59-03-00
<b>Japan</b>		
General Information*		0120-101-589
Technical Support*		0120-101-589
Windows 95 Support*		0120-505-589
Order Software Backup *		0120-250-589
FaxStation		81-3-5402-0991
<b>Korea</b>		
General Information		82-2-3470-07001
Technical Support		82-2-523-3575 82-082-902-77774

*Continued*



**Worldwide Telephone Numbers** Continued

<b>Location</b>	<b>Country Code</b>	<b>Telephone Number</b>
<b>Malaysia</b>		
General Information		603-717-1188
Technical Support		603-718-1636
<b>Mexico</b>		
General Information	+52	-5-229-7900
Technical Support	+52	-5-229-7910
PaqFax	+52	-5-229-7920
<b>Netherlands</b>		
General Information		0182-565805
Customer Support*		06-91681616 (Dfl. 0.75/min)
Fax*		06-8991116 (Dfl. 0.40/min)
QuickLine Bulletin Board		0182-572366
<b>New Zealand</b>		
General Information		64-9-307-3969
<b>Norway</b>		
General Information	+47	-22-07-20-00
Technical Support	+47	-22-07-20-20
<b>Poland</b>		
General Information	+48	-2-630-3535
Technical Support	+48	-2-630-3535
<b>Portugal</b>		
General Information	+351	-1-4128400
Technical Support	+351	-1-4128460
<b>Russia</b>		
General Information	+7	-095-967-1700
Technical Support	+7	-095-967-1700
PaqFax	+7	-095-967-1701

*Continued*

**Worldwide Telephone Numbers** Continued

<b>Location</b>	<b>Country Code</b>	<b>Telephone Number</b>
<b>Singapore</b>		
General Information		65-753-6688
Customer Support Center		65-750-3030
PaqFax		65-750-4514
<b>South Africa</b>		
General Information		27-11-728-6999
Technical Support		27-11-728-6999
<b>Spain</b>		
General Information	+34	-902.10.14.14
Technical Support	+34	-1-640-1302
<b>Sweden</b>		
General Information	+46	-8-703-5240
Technical Support	+46	-8-703-5240
PaqFax (hämtfax)	+46	-8-703-5225
QuickLine (BBS)	+46	-8-703-5220
<b>Switzerland</b>		
General Information		0844 844 111
Technical Support		01/838 22 22 (German) 01/838 22 23 (French)
QuickLine Bulletin Board		01/838-24 21
Order Software Backup		0800 556 206
<b>Taiwan</b>		
General Information		886-2-7351000
Technical Support		886-2-3761170
BBS		886-2-3761175
<b>Thailand</b>		
General Information		62-2-679-6222

*Continued*

**Worldwide Telephone Numbers** Continued

---

<b>Location</b>	<b>Country Code</b>	<b>Telephone Number</b>
<b>United Arab Emirates (Dubai)</b>		
General Information	+97	14 -818100
<b>United Kingdom</b>		
General Information		0990-134456
FaxPaq		0181-332-3550
QuickLine Bulletin Board		0181-332-9499
<b>United States</b>		
Product Information*		1-800-345-1518
Technical Support*		1-800-OKCOMPAQ (1-800-652-6672)
PaqFax*		1-800-345-1518, Option 1
Download Facility (modem access only)		1-281-518-1418
Order Software Backup*		1-800-952-7689
Battery Pack Recycling*		1-800-524-9859
<b>Venezuela</b>		
General Information	+58	-2-953-6944

---



# *appendix* **B**

## POST ERROR MESSAGES

The following table lists selected error codes that you may encounter during the Power-On Self-Test (POST). The POST occurs after you first turn on the computer. A successful POST is followed by one or two short beeps.

If one of the error codes listed below is displayed on the screen during POST, follow the instructions in the recommended action. If you receive an error code not listed here, contact your Compaq authorized service provider. You also may wish to run Computer Checkup; see Chapter 14, “Diagnostics,” for information about this utility.

**NOTE:** If QuickBoot is enabled, the POST is minimized to hasten your start-up time.

POST Error Codes			
Error Code	Beeps	Probable Cause	Action
162-System Options Error	2S	Configuration error	Run Computer Checkup (See Chapter 14.)
162-System Options Not Set	2S	Configuration incorrect	Run Computer Checkup (See Chapter 14.)
162-System Options Not Set (Run SETUP)	2S	CMOS reflects that an invalid configuration has been set	Run Computer Checkup (See Chapter 14)

*Continued*

## Post Error Codes *Continued*

Error Code	Beeps	Probable Cause	Action
163-Time & Date Not Set	2S	Invalid time	Run Computer Checkup (See Chapter 14.)
164-Memory Increase Detected	2S	Discrepancy in the memory size found compared to the one stored in CMOS	No action is required
164-Memory Decrease Detected	2S	Discrepancy in the memory size found compared to the one stored in CMOS	If you removed a memory expansion board prior to turning on the computer, no action is required. Otherwise, contact a Compaq authorized service provider.
208-Invalid Memory Expansion Board	None	The memory expansion board is an invalid type	Replace memory expansion board.
605-Diskette Drive Error	None	Mismatch in drive type	Run Computer Checkup. (See Chapter 14.)
605-Diskette Drive Type Error (Run SETUP)	2S	Disk type does not match the drive	Run Computer Checkup. (See Chapter 14.)
1150-COMM Port Configuration Error	2S	Added or removed modem, or serial interface board	Run Computer Checkup. (See Chapter 14.)
Audible	1S	Power-on successful	None.
Audible	2S	Power-on successful	None.
(Resume="F1" Key)	None	As indicated to continue	Press <b>F1</b> key.

# appendix C

## CONNECTOR PIN ASSIGNMENTS

---

### Parallel Connector

---

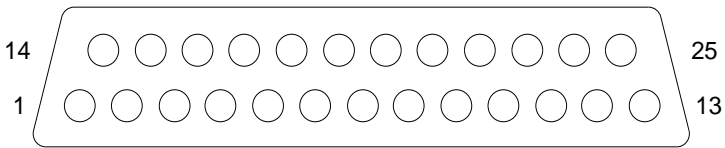

---

Pin	Signal	Pin	Signal
1	Strobe*	13	Select
2	Data Bit 0	14	Auto Linefeed*
3	Data Bit 1	15	Error*
4	Data Bit 2	16	Initialize Printer*
5	Data Bit 3	17	Select In*
6	Data Bit 4	18	Ground
7	Data Bit 5	19	Ground
8	Data Bit 6	20	Ground
9	Data Bit 7	21	External FDD Detect
10	Acknowledge*	22	External FDD Detect
11	Busy	23	Ground
12	Paper Out	24	Ground
		25	External FDD +5V

---

---

## Serial Connector

---

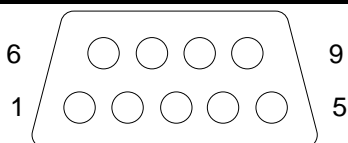

---

Pin	Signal	Pin	Signal
1	Carrier Detect	6	Data Set Ready
2	Receive Data	7	Ready to Send
3	Transmit Data	8	Clear to Send
4	Data Terminal Ready	9	Ring Indicator
5	Ground		

---

## Keyboard/Mouse Connector

---

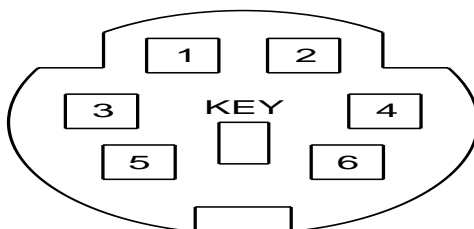

---

Pin	Signal	Pin	Signal
1	External Mouse Data	4	+ 5V
2	External Keyboard Data	5	External Mouse Clock
3	Ground	6	External Keyboard Data

---



## External VGA Monitor Connector

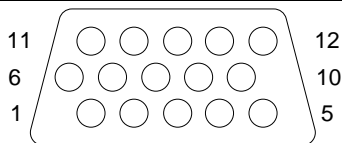

Pin	Signal	Pin	Signal
1	Red Analog	9	Not Connected
2	Green Analog	10	Ground
3	Blue Analog	11	Not Connected
4	Not Connected	12	DDCD
5	Ground	13	Horizontal Sync
6	Ground	14	Vertical Sync
7	Ground	15	DDCC
8	Ground		

## Docking Base Connector

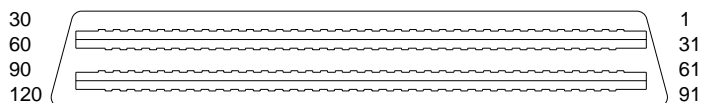

Pin	Signal	Pin	Signal
1	CRT Green Analog	31	PEB +5V
2	CRT Blue Analog	32	CRT Red Analog
3	CRT Horizontal Sync	33	Ground
4	CRT Vertical Sync	34	Ground
5	Convenience Bay ID*	35	Ground
6	Printer Data 0	36	Printer Strobe*
7	Printer Data 1	37	Ground
8	Printer Data 2	38	Printer Auto Linefeed
9	Printer Data 3	39	IRQ15
10	Printer Data 4	40	Printer Error*
11	Printer Data 5	41	Ground
12	Printer Data 6	42	Printer Initialize*

*Continued*

**Docking Base Connectors** Continued

---

<b>Pin</b>	<b>Signal</b>	<b>Pin</b>	<b>Signal</b>
13	Printer Data 7	43	Ground
14	Printer Acknowledge	44	Printer Select In*
15	Printer Busy	45	Ground
16	Printer Paper Out	46	Printer Select
17	Serial Receive Data	47	Serial Carrier Detect*
18	Serial Transmit Data	48	Serial Data Terminal Ready*
19	Serial Data Set Ready	49	Serial Ready to Send*
20	Serial Clear to Send	50	Serial Ring Indicate*
21	Keyboard Data	51	PS2 Data
22	Keyboard Clock	52	PS2 Clock
23	Game Port 7	53	Game Port 5
24	Game Port 6	54	Game Port 4
25	PEB Power On*	55	NIC Select
26	Ground	56	Ground
27	Ground	57	Ground
28	CD Audio Left	58	CD Audio Right
29	Midi In	59	+VBAT
30	Midi Out	60	+VBAT

---

*Continued*

**Docking Base Connector** Continued

<b>Pin</b>	<b>Signal</b>	<b>Pin</b>	<b>Signal</b>
61	CD Reset*	91	Sec IDE Data 0
62	PEB +5V	92	Sec IDE Data 1
63	Sec IDE Data 2	93	Sec IDE Data 4
64	Sec IDE Data 3	94	Sec IDE Data 5
65	Sec IDE Data 6	95	Sec IDE Data 8
66	Sec IDE Data 7	96	Sec IDE Data 9
67	Sec IDE Data 10	97	Sec IDE Data 12
68	Sec IDE Data 11	98	Sec IDE Data 13
69	Sec IDE Data 14	99	Sec IDE Data 15
70	Ground	100	Sec IDE IO Write*
71	Sec IDE IO Read*	101	Sec IDE IO Ready
72	Ground	102	IRQ14
73	Port84 Enable*	103	No Connection
74	Ground	104	Sec IDE Data Address 0
75	Sec IDE Data Address 1	105	Sec IDE Data Address 2
76	Ground	106	CDPDIAG
77	Sec IDE Chip Sel (300 range)	107	Sec IDE Chip Sel (100 range)
78	Ground	108	CDDASP*
79	Ground	109	Ground
80	PEB ID*	110	Game Port 2
81	Game Port 3	111	Game Port 0
82	Ground	112	Game Port 1
83	MBATT	113	External Audio Select*
84	WT_MCLK	114	I <sup>2</sup> C Clock
85	WT_MSD	115	I <sup>2</sup> C Data
86	RSTB*	116	Exp Ro
87	Ground	117	Ground
88	+VBAT	118	Exp Lo
89	+VBAT	119	Ground
90	+VBAT	120	Ground



## POWER CORD SET REQUIREMENTS

The wide-range input feature of your AC Adapter permits it to operate from any line voltage between 100 to 240 volts AC.

The power plug or power cord set (appliance coupler, flexible cord, and wall plug) you received with your AC Adapter meets the requirements for use in the country where you purchased your computer.

Power cord sets for use in other countries must meet the requirements of the country where you use the AC Adapter. For more information on power cord set requirements, contact your Compaq authorized dealer.

### General Requirements

The requirements listed below are applicable to all countries:

1. The length of the power cord set must be at least 6.00 feet (1.8 m) and a maximum of 9.75 feet (3.0 m).
2. All power cord sets must be approved by an acceptable accredited agency responsible for evaluation in the country where the power cord set will be used.
3. The power cord set must have a minimum current capacity of 2.5A and a nominal voltage rating of 125 or 250 volts AC, as required by each country's power system.
4. The appliance coupler must meet the mechanical configuration of an EN 60 320/IEC 320 Standard Sheet C5 connector, for mating with appliance inlet on the AC Adapter.

# Country-Specific Requirements

Power Cord Set Requirements		
Country	Accredited Agency	Applicable Note Numbers
Australia	EANSW	1
Austria	OVE	1
Belgium	CEBC	1
Canada	CSA	2
Denmark	DEMKO	1
Finland	FIMKO	1
France	UTE	1
Germany	VDE	1
Italy	IMQ	1
Japan	JIS	3
The Netherlands	KEMA	1
Norway	NEMKO	1
Sweden	SEMKO	1
Switzerland	SEV	1
United Kingdom	BSI	1
United States	UL	2

**Notes:**

1. Flexible cord must be <HAR> Type HO3VV-F, 3-conductor, .75 mm<sup>2</sup> conductor size. Power cord set fittings (appliance coupler and wall plug) must bear the certification mark of the agency responsible for evaluation in the country where it will be used.
2. Flexible cord must be Type SPT-2 or equivalent, No. 18 AWG, 3-conductor. Wall plug must be a two-pole grounding type with a NEMA 5-15P (15A, 125V) or NEMA 6-15P (15A, 250V) configuration.
3. Appliance coupler, flexible cord, and wall plug must bear a “T” mark and registration number in accordance with the Japanese DENTORI Law. Flexible cord must be Type VCT or VCTF, 3-conductor, 0.75 mm<sup>2</sup> conductor size. Wall plug must be a two-pole grounding type with a Japanese Industrial Standard C8303 (15A, 125V) configuration.

# appendix *E*

## ELECTROSTATIC DISCHARGE

A discharge of static electricity from a finger or other conductor may damage system boards or other static-sensitive devices. This type of damage may reduce the life expectancy of the device.

### Preventing Electrostatic Discharge

To prevent electrostatic damage, observe the following precautions:

- Avoid hand contact by transporting and storing products in static-safe containers.
- Keep electrostatic-sensitive parts in their containers until they arrive at static-free workstations.
- Place parts on a grounded surface before removing them from their containers.
- Avoid touching pins, leads, or circuitry.
- Always be properly grounded when touching a static-sensitive component or assembly.

### Grounding Methods

There are several methods for grounding. Use one or more of the following methods when handling or installing electrostatic-sensitive parts.

- Use a wrist strap connected by a ground cord to a grounded workstation or computer chassis. Wrist straps are flexible straps with a minimum of 1 megohm +/- 10 percent resistance in the ground cords. To provide proper ground, wear the strap directly against the skin.



- Use heelstraps, toestraps, or bootstraps at standing workstations. Wear the straps on both feet when standing on conductive floors or dissipating floor mats.
- Use conductive field service tools.
- Use a portable field service kit with a folding static-dissipating work mat.

**IMPORTANT:** If you do not have the suggested equipment for proper grounding, contact a Compaq authorized reseller or service provider. For more information on static electricity or assistance with product installation, contact your Compaq authorized service provider.

# appendix *F*

## AGENCY REGULATORY NOTICES

### Agency Regulatory Identification Numbers

The following options have been evaluated for use with your computer. These Compaq approved options can be identified by their assigned series numbers that are listed below. To ensure continued reliable and safe operation of your computer, only these options should be used.

<b>Agency Regulatory Identification Numbers</b>	
<b>Options</b>	<b>Series Numbers</b>
Notebook CPUs	2870, 2870A, 2870B, 2870C, 2870D and 2870E
Notebook CPU with Display Upgrade	2870B UD, 2870C UD, 2870D UD, and 2870E UD
Convenience Base	2875A
Convenience Base - Ethernet	2875
Extended Life NiMH Battery Pack	2831A
Automobile Adapter	2874
Display Upgrade	2870 D-Conv
AC Adapter	2872, 2872A
Mobile CD Expansion Unit	2876
External Battery Charger	2873
Modular Battery Pack	2871B, 2871C, 2871E
Handle Battery Pack	2871, 2871A, 2871D

# Federal Communications Commission Notice

This equipment has been tested and found to comply with the limits for a Class B digital device, pursuant to Part 15 of the FCC Rules. These limits are designed to provide reasonable protection against harmful interference in a residential installation. This equipment generates, uses, and can radiate radio frequency energy and, if not installed and used in accordance with the instructions, may cause harmful interference to radio communications. However, there is no guarantee that interference will not occur in a particular installation. If this equipment does cause harmful interference to radio or television reception, which can be determined by turning the equipment off and on, the user is encouraged to try to correct the interference by one or more of the following measures:

- Reorient or relocate the receiving antenna.
- Increase the separation between the equipment and receiver.
- Connect the equipment into an outlet on a circuit different from that to which the receiver is connected.
- Consult the dealer or an experienced radio or television technician for help.

## Modifications

The FCC requires the user to be notified that any changes or modifications made to this device that are not expressly approved by Compaq Computer Corporation may void the user's authority to operate the equipment.

## Cables

Connections to this device must be made with shielded cables with metallic RFI/EMI connector hoods to maintain compliance with FCC Rules and Regulations.

## Declaration of Conformity (United States only)

This device complies with Part 15 of the FCC Rules. Operation is subject to the following two conditions: (1) this device may not cause harmful interference, and (2) this device must accept any interference received, including interference that may cause undesired operation.

To identify this product, refer to the Series number found on the product. For questions regarding this declaration, write

Compaq Computer Corporation  
P. O. Box 692000, Mail Stop 510101  
Houston TX 77269-2000

or call

(281) 514-3333.

## Canadian Notice

This Class B digital apparatus meets all requirements of the Canadian Interference-Causing Equipment Regulations.

## Avis Canadien

Cet appareil numérique de la classe B respecte toutes les exigences du Règlement sur le matériel brouilleur du Canada.

## European Notice

Products with the CE Marking comply with both the EMC Directive (89/336/EEC) and the Low Voltage Directive (73/23/EEC) issued by the Commission of the European Community.

Compliance with these directives implies conformity to the following European Norms:

- EN55022 (CISPR 22)—Electromagnetic Interference
- EN50082-1 (IEC801-2, IEC801-3, IEC801-4)—  
Electromagnetic Immunity
- EN60950 (IEC950)—Product Safety

## Japanese Notice

本装置は、第二種情報装置（住宅地域またはその隣接した地域において使用されるべき情報装置）で住宅地域での電波障害防止を目的とした情報処理装置等電波障害自主規制協議会（VCCI）基準に適合しております。  
しかし、本装置をラジオ、テレビジョン受信機に、近接してご使用になると、受信障害の原因となることがあります。本書の説明にしたがって正しい取り扱いをしてください。

# German Ergonomics Notice

The Compaq have been evaluated and found to comply with the requirements of ZH 1/618, 1980. The computers were evaluated using MS-DOS Version 3.31 or higher, BASICA/T, and the EGA\_THIN.CPI character set, as published by Compaq. In order to meet the minimum contrast requirements of ZH 1/618 when used in a negative polarity mode to display light characters on a dark background, the character colors red and blue should be used in the high intensity/bright color mode. Positive polarity displays (dark characters on a light background) do not meet the background reflection requirements of ZH 1/618.

## Airline Travel Notice

Use of electronic equipment aboard commercial aircraft is at the discretion of the airline.

## Battery Notice



**WARNING:** Your computer is provided with a Lithium battery-powered Real-Time Clock circuit. There is a danger of explosion and risk of personal injury if the battery is incorrectly replaced or not handled properly. Do not attempt to recharge the battery, disassemble it, immerse it in water, or dispose of it in fire. Replacement is to be done by a Compaq authorized service provider using the Compaq spare designated for this product.

---



**WARNING:** Your computer contains an internal Nickel Metal Hydride or Lithium Ion Battery Pack. There is risk of fire and chemical burns if the battery pack is not handled properly. Do not disassemble, crush, puncture, short external contacts, or dispose of in fire or water. Do not expose to temperatures higher than 60° C.

---

Battery packs and the Real Time Clock Battery should be recycled or disposed of according to local regulations.



## Energy Star Compliance

Compaq notebook computers are compliant with the U.S. Environmental Protection Agency's (EPA) Energy Star Computers Program. The Energy Star Computers Program was created by the EPA to promote energy efficiency and reduce air pollution through more energy-efficient equipment in homes, offices and factories. Compaq products achieve this by reducing the power consumption when not being used. Using the power-saving features will reduce energy use and maximize battery life.

# appendix G

## SPECIFICATIONS

This appendix provides physical and performance specifications for subassemblies of the computer:

- Computer
- Display
- Diskette Drive
- Hard Drives
- AC Adapter
- Auto Adapter
- Battery Pack

---

<b>Computer</b>		
	<b>U.S.</b>	<b>Metric</b>
<b>Dimensions</b>		
Height	1.49 in	37.85 mm
Depth	10.20 in	259.48 mm
Width	11.40 in	289.56 mm
<b>Weight (w/o battery Handle)</b>		
	4.94 lbs	2.24 kg
<b>Weight (w/battery Handle)</b>		
	6.233 lbs	2.83 kg
<b>Weight (w/bay battery)</b>		
	5.317	2.41 kg
<b>Stand-Alone (Battery) Power Requirements</b>		
Operating Voltage	100 to 240 VAC RMS	100 to 240 VAC RMS
Operating Current	1.10 A RMS	1.10 A RMS
Operating Frequency Range	50 to 60 Hz AC	50 to 60 Hz AC
Maximum Transient	4/50 kV	4/50 kV

---

*Continued*

Computer, *continued*

	U.S.	Metric
<b>Environmental Requirements</b>	<b>Temperatures</b>	<b>Relative Humidity</b>
Operating	5 to 95 °F	10° to 35°C
Nonoperating	-4° to 140°F	-20° to 60°C
Operating	10% to 90%	10% to 90%
Nonoperating	5% to 95%	5% to 95%

**Color TFT Display**

	U.S.	Metric
<b>Dimensions (display size)</b>		
Height	6.3 in	16.0 cm
Width	8.4 in	21.3 cm
<b>Number of Colors</b>	256, 32K, 64K and 16M at 800 x 600 Display	
<b>Contrast Ratio</b>	100:1	
<b>Brightness</b>	70 CD/M <sup>2</sup> @ 4.0 mA	
<b>Pixel Resolution</b>		
Pitch	0.264 x 0.264 mm	
Format	800 x 600	
Configuration	RGB Stripe	
<b>Backlight</b>	Edge-Lit	
<b>Character Display</b>	80 x 25	
<b>Total Power Consumption</b>	3.2 W (Maximum)	



---

## Diskette Drive

---

**Diskettes**

Size	3.5 in (8.9 cm)
High Density (MB)	1.44
Low Density (KB)	720

---

**Light** None

---

**Height** 0.43 in (11 mm)

---

**Bytes per Sector** 512

---

**Sectors per Track**

High Density	18
Low Density	9

---

**Tracks per Side**

High Density	80
Low Density	80

---

**Read/Write Heads** 2

---

**Average Access Time (ms)**

Track-to-Track (high/low)	3/6
Average (high/low)	94/174
Settling Time (ms)	15
Latency Average (ms)	100

---

---

## Hard Drives

---

<b>Model Standard Configurations</b>	3.2 GB	4.0 GB
<b>Formatted Capacity (Per Drive)</b>		
Physical (MB)	3250.7	4114.0
Logical (MB)	3251.4	4099.8
<b>Drive Type</b>	65	65
<b>Drive Size</b>		
Inches	4.0 x 2.740 x 0.5	4.0 x 2.740 x 0.5
millimeters	100 x 70 x 12.7	100 x 70 x 12.7
<b>Transfer Rate</b>		
Media (Mbits/Sec)	39.6 to 71.5	51.7 to 83.4
Interface (Mbytes/Sec)	16.6	16.6
<b>Sector Interleave</b>	1:1	1:1
<b>Typical Seek Time (including settling)</b>		
Single Track (ms)	2.5	4.0
Average (ms)	13.0	13.0
Full Stroke (ms)	23.0	23.0
<b>Disk Rotational Speed (RPM)</b>	4000	4000
<b>Physical Configuration</b>		
Cylinders	6371	6975
Data Heads	6	6
Sectors per Track	117 to 216	144 to 240
Bytes per Sector	512	512
<b>Logical Configuration</b>		
Cylinders	6300	7944
Heads	16	16
Sectors	63	63
<b>Buffer Size (KB)</b>	128	512

---

**Note:** Actual drive parameters may vary.

---

## AC Adapter

---

	U.S.	Metric
<b>Dimensions</b>	5.0 x 3.0 x 1.3 in.	12.7 x 7.6 x 3.3 cm
<b>Power Supply Ratings</b>		
Rated Voltage Range	120 - 240 V AC	
Rated Input Current	<1.0 Amp	
Rated Input Frequency	50 to 60 Hz	
Maximum Output Voltage	+18.5 +/-0.25 V DC	
Maximum Output Current	42 W	

---

## Lithium Ion Modular Battery Pack

---

	U.S.	Metric
<b>Dimensions</b>		
Height	0.77 in	19.6 mm
Length	5.34 in	135.6 mm
Width	4.35 in	110.0 cm
<b>Weight</b>	0.88 lb	399 g
<b>Energy</b>		
Voltage	14.4 V dc	
Amp-hour Capacity	2.6 Ah	
Watt-hour Capacity	37.4 Wh	
<b>Environmental Requirements</b>		
Operating temperatures	50°F to 104°F	10°C to 40°C
Nonoperating temperature	-12°F to 140°F	-30°C to 60°C

---

---

## Lithium Ion Handle Battery Pack

---

	U.S.	Metric
<b>Dimensions</b>		
Height	0.89 in	15.2 mm
Length	11.00 in	279.0 mm
Width	1.53 in	38.8 cm
<b>Weight</b>		
	0.88 lb	399 g
<b>Energy</b>		
Voltage	14.4 V dc	
Amp-hour Capacity	2.6 Ah	
Watt-hour Capacity	37.4 Wh	
<b>Environmental Requirements</b>		
Operating temperatures	50°F to 104°F	10°C to 40°C
Nonoperating temperature	-12°F to 140°F	-30°C to 60°C

---

## Nickel Metal Hydride Handle Battery Pack

---

	U.S.	Metric
<b>Dimensions</b>		
Height	0.89 in	15.2 mm
Length	11.00 in	279.0 mm
Width	1.53 in	38.8 mm
<b>Weight</b>		
	1.05 lb	457 g
<b>Energy</b>		
Voltage	12.0 V dc	
Amp-hour Capacity	2.1 Ah	
Watt-hour Capacity	25.0 Wh	
<b>Environmental Requirements</b>		
Operating temperatures	50°F to 104°F	10°C to 40°C
Nonoperating temperature	-4°F to 86°F	-20°C to 30°C

---

# INDEX

## A

- AC Adapter
  - cautions, 5-7
  - connecting, 5-8
  - specifications, G-5
- application software
  - installing, 11-2
- arrow keys, 2-5
- asset management, 16-2
- AssetControl, 16-2
- audio
  - components, 9-2
  - connectors, 2-2
  - features, 9-1
  - internal microphone, 9-5
  - jacks, 9-3
  - stereo connector, 9-4
  - stereo speakers, 2-5, 9-7
  - volume control, 9-6

## B

- backlight
  - CTFT, G-2
- backup CDs, 1-2
- backup diskettes, 1-2
- battery
  - battery charge indicator, 2-6
  - battery gauge, 3-7
  - conservation, 3-7
  - low-battery condition, 5-11
  - power requirements, G-1
  - problems, 15-3
- battery conservation, 5-17
  - Energy Star compliance, F-5
  - timeouts, 5-18
- battery gauge popup
  - instructions, 5-20
- battery pack
  - charging, 5-13
  - discharging, 15-3
  - extending operating time, 5-12
  - fast charge cycles, 5-12
  - locations, 5-9
  - operating temperatures, G-5, G-6

- recycling in Europe, 5-14
  - recycling in North America, 5-14
  - setting conservation level, 5-17
  - specifications, G-5, G-6
  - storing, 5-12, 15-5
- beeps
    - identifying low-battery condition, 5-11
- brightness
    - CTFT, G-2
- brightness control, 3-7

## C

- cable lock, 2-2, 12-7
- CardBus. *See* PC Cards
- Compaq authorized dealer, reseller,
  - service provider
    - locating, 15-22, 15-23
- components
  - bottom panel, 2-9
  - front and left side, 2-2
  - front and right side, 2-3
  - handle, 2-10
  - keyboard, 2-4
  - rear, 2-7
  - status panel, 2-6
- computer
  - caring for, 13-2
  - shipping, 13-4
  - travel guidelines, 13-3
- computer checkup (TEST)
  - running, 14-2
- configuration and diagnostics menu
  - accessing, 14-2
- connector pin assignments, C-1
  - docking base connector, C-3
  - external VGA monitor connector, C-3
  - keyboard/mouse connector, C-2
  - parallel connector, C-1
  - serial connector, C-2
- connectors, 2-1
  - expansion, 2-9
  - external monitor, 2-7
  - infrared lens, 2-7
  - keyboard/mouse, 2-7
  - NTSC/PAL Video, 2-8

- parallel, 2-7
- serial, 2-7
- contrast ratio
  - CTFT, G-2
- controls
  - brightness, 3-7
  - contrast, 3-7
- conventions used in guide, xi
- CTFT
  - backlight, G-2
  - pixel resolution, G-2
  - specifications, G-2
- CTFT
  - brightness, G-2
  - contrast ratio, G-2
- Customer Support Center
  - telephone number, 15-23

## D

- device drivers
  - installing, 15-8
- Device Manager utility, 10-2
- diagnostics, 14-2
  - automatic, 14-3
  - hard drive, 14-4
  - memory configuration, 14-4
  - modem, 14-4
  - operating system, 14-4
  - printer, 14-4
  - processor, 14-4
  - prompted, 14-3
  - Quick Check, 14-3
  - ROM versions, 14-4
  - running
    - Compaq Diagnostics for Windows, 14-5
    - computer checkup (TEST), 14-2
    - video, 14-4
- diskette drive
  - inserting diskette, 7-2
  - specifications, G-3
  - weight saver module, 7-2
- display
  - problems, 15-15
  - reducing brightness, 5-12
- drivers. *See* device drivers
- DualBay
  - AC power connector, 2-3
  - features, 2-3, 2-9
  - inserting diskette drive, 7-2
  - latch release, 2-3

- removing battery, 7-5
- removing diskette drive, 7-3

## E

- electrostatic discharge
  - grounding methods, E-1
  - preventing, E-1
- embedded numeric keypad, 2-4
- Energy Star compliance, F-5
- ESD. *See* electrostatic discharge
- external diskette drive, 8-1
- external monitor, 3-6, 15-17
- external monitor connector, 2-7

## F

- fault management, 16-2
- floppy disk drive. *See* diskette drive
- function keys, 2-4, 3-8

## G

- grounding methods, E-1

## H

- handle, 2-10
  - attaching, 6-2
  - detaching, 6-3
  - features, 2-10
- handle battering
  - inserting, 6-7
  - removing, 6-5
- hard drive
  - diagnostics, 14-4
  - problems, 15-7
  - removing, 15-7
- hard drive compartment, 2-9
- Hibernation, 5-6
  - after adding memory, 5-19
  - exiting, 5-7
  - extending battery operating time, 5-12
  - features, 5-6
  - hotkeys, 3-7
  - initiating, 5-6
  - setting, 5-19
- hotkeys

- battery conservation, 3-7
- controlling display, 15-16
- identifying, 3-6

## I

### indicators

- battery charge, 2-6
- Caps Lock, 2-6
- Num Lock, 2-6
- power/standby, 2-6
- Scroll Lock, 2-6
- status panel, 2-6

### information

- Customer Support Center, 15-22,  
15-23
- service, 15-23

### infrared

- connecting, 10-10
- tips for using, 10-10

### infrared lens, 2-7

### INSPECT utility, 14-4

### Intelligent Manageability

- AssetControl, 16-2
- Compaq Insight Personal Edition,  
16-2
- Enterprise Management, 16-1
- fault management, 16-2
- features, 16-1
- how to access, 16-1
- IntelliSafe, 16-2
- security management, 16-3
- temperature sensing, 16-2

### IrDA. *See* infrared port

## K

### keyboard

- cursor movement, 2-5
- embedded numeric keypad, 2-4
- function keys, 2-4, 3-8
- hotkeys, 3-6
- numeric keypad, 3-8
- pointing device, 2-5
- problems, 15-9
- status panel, 2-4
- stereo speakers, 2-5
- suspend, 2-4
- user-programmable keys, 2-4, 3-2

### keyboard/mouse

- connector, 2-7

## M

### MCD

- expansion slot, 2-9

### memory

- configuration, 14-4
- problems, 15-10

### messages

- error, B-1
- on screen examples, 15-2

### monitor

- external, 15-17
- self-test, 15-10

### mouse. *See* pointing device

## N

### NTSC/PAL

- connecting, 10-8
- uses, 2-8

### numeric keypad, 3-8

## O

### online references, 1-1

- Compaq Dictionary*, 1-1
- Compaq Reference Guide*, 1-1
- Safety & Comfort Guide*, 1-1
- Windows interface, 1-2

### operating system

- diagnostics, 14-4
- replacing, 11-2

### options

- approved, F-1

## P

### parallel connector, 2-7

### passwords, 12-2

- if you forget, 12-3
- setting power on password, 12-2
- setup password, 12-4

### PC Cards

- eject buttons, 2-2
- inserting, 10-5
- PC Card Solution logo, 10-3
- problems, 15-11
- removing, 10-6
- slots, 2-2

- types, 10-3
- PCMCIA. *See* PC Cards
- pixel resolution
  - CTFT, G-2
- pointing device
  - cleaning, 15-20
  - features, 2-9
  - installing, 4-7
  - Mouse utility, 4-2
  - problems, 15-18
  - removing, 4-5
  - touchpad, 4-3
- POST, *See* Power-On Self Test, B-1
- power
  - power button, 2-4, 5-2
  - power properties utility, 5-15
  - problems, 15-13
  - when to turn off, 5-3
- power cord requirements, D-1
- Power properties
  - how to access, 5-15
- Power-On Self-Test (POST), 14-1
- printed references, 1-1
  - Microsoft Windows Operating System Guide, 1-1
  - quick setup poster, 1-1
  - Reference Guide*, 1-1
  - Safety & Comfort Guide*, 1-1
  - warranty, 1-1
- printer
  - diagnostics, 14-4
  - problems, 15-14
  - self-test, 15-15
- Printing the screen, 3-8
- problem solving, *See* troubleshooting, 15-1
- processor
  - diagnostics, 14-4

## Q

- quick controls
  - identifying, 12-5
  - initiating, 12-6
- QuickBlank, 3-7, 12-5
- QuickBoot, 12-6
- QuickLock, 3-7, 12-5

## R

- real-time clock battery, 15-4

- references
  - online, 1-1
  - printed, 1-1
- regulatory agency identification
  - numbers, F-1
- routine care, 13-2

## S

- ScanDisk, 15-6, 15-7
- screen
  - messages, 15-2
  - problems, 15-15
- security
  - cable lock, 12-7
  - quick controls, 12-5
- security management utility
  - disabling password, 15-22
- serial connector, 2-7
- serial number, 1-2
- service information, 15-22, 15-23
- shipping computer, 13-4
- shipping guidelines, 13-4
- software
  - application problems, 15-17
  - installing, 11-2
- software drivers. *See* device drivers
- solving problems. *See* troubleshooting
- sound
  - problems, 15-17
- specifications
  - AC Adapter, G-5
  - battery pack, G-5, G-6
  - CTFT, G-2
  - diskette drive, G-3
- static electricity. *See* electrostatic discharge
- status panel, 2-4
  - indicators, 2-6
  - power/suspend light, 5-2
- status panel indicators, 2-8
- stereo speakers, 9-7
- storage temperatures for battery pack, 15-5
- Suspend, 2-4, 5-3
  - button, 5-4
  - exiting, 5-5
  - extending battery operating time, 5-12
  - in low battery, 5-5
  - initiating, 5-4
- symbols used in guide, xi



system configuration

changing, 14-1

errors, 14-1

## T

telephone numbers

Customer Support Center, 15-23

television

NTSC/PAL, 2-8

temperatures

operating, G-2

operating battery pack, G-5, G-6

storing battery pack, 5-12, 15-5

TEST (computer checkup) utility, 14-2

timeouts

battery conservation, 5-18

how to use, 5-18

setting, 5-18

touchpad

cleaning, 4-3

components, 4-3

using, 4-3

trackball

cleaning, 15-20

travel guidelines, 13-3

troubleshooting

battery, 15-3

cleaning trackball, 15-20

diskette/diskette drive, 15-6

display screen, 15-15

hard drive, 15-7

hardware installation, 15-8

helpful hints, 15-1

memory, 15-10

minor problems, 15-3

monitor self-test, 15-10

numeric keypad, 15-9

PC Cards, 15-11

pointing device, 15-18

power, 15-13

printer, 15-14

software, 15-17

sound, 15-17

TV

connecting NTSC/PAL, 10-8

typographical conventions, xi

## U

upgrading

hard drive, 11-5

user-programmable keys, 2-4, 3-2

assigning, 3-2, 3-3

key assignments, 3-4

schemes, 3-4

unassigning, 3-3

utilities

Add New Hardware, 10-2

Device Manager, 10-2

## V

video

diagnostics, 14-4

view system information (INSPECT)

running, 14-4

volume control

with hotkeys, 9-6

volume control

with hotkeys, 3-6

## W

warranty, 1-1

wireless data transfer, 10-10

worldwide telephone numbers, A-1

