

user guide

hp StorageWorks network storage router e1200-160

Product Version: 2.0

Third Edition (April 2003)

Part Number: 325741-001

The HP StorageWorks Network Storage Router provides bidirectional connectivity in a Fibre Channel Switched Fabric supporting Fibre Channel and SCSI devices.

This user guide provides an overview, instructional information for configuration, and basic troubleshooting of the router.



© Hewlett-Packard Company, 2003.

Hewlett-Packard Company makes no warranty of any kind with regard to this material, including, but not limited to, the implied warranties of merchantability and fitness for a particular purpose. Hewlett-Packard shall not be liable for errors contained herein or for incidental or consequential damages in connection with the furnishing, performance, or use of this material.

This document contains proprietary information, which is protected by copyright. No part of this document may be photocopied, reproduced, or translated into another language without the prior written consent of Hewlett-Packard. The information contained in this document is subject to change without notice.

Compaq Computer Corporation is a wholly-owned subsidiary of Hewlett-Packard Company.

Microsoft®, MS-DOS®, MS Windows®, Windows®, and Windows NT® are U.S. registered trademarks of Microsoft Corporation.

UNIX® is a registered trademark of The Open Group.

Hewlett-Packard Company shall not be liable for technical or editorial errors or omissions contained herein. The information is provided "as is" without warranty of any kind and is subject to change without notice. The warranties for Hewlett-Packard Company products are set forth in the express limited warranty statements accompanying such products. Nothing herein should be construed as constituting an additional warranty.

Network Storage Router e1200-160
Third Edition (April 2003)
Part Number: 325741-001



contents

About this Guide	9
Overview	10
Intended Audience	10
Prerequisites	10
Related Documentation	10
Conventions	11
Document Conventions	11
Text Symbols	12
Equipment Symbols	12
Rack Stability	13
Getting Help	14
HP Technical Support	14
HP Storage Website	14
HP Authorized Reseller	15
1 Introduction	17
External Features Overview	18
Power Indicator	19
Serial Port	19
Ethernet Port	19
Fibre Channel Port	19
SCSI Buses	19
Functional Overview	20
Fibre Channel to SCSI Protocol Process	21
SCSI to Fibre Channel Protocol Process	22
LAN-free Backup and Restore	23

Router Specifications	23
Operating Environmental Requirements	23
Shipping and Storing Environmental Requirements	24
Power Requirements	24
2 Configuration Overview	25
Router Default Ethernet Settings	26
UI Overview	27
Visual Manager	27
Serial	27
Telnet	28
FTP	28
Common Configuration Settings	29
Controller LUN Commands	29
SCSI Bus Configuration	29
Fibre Channel Port Configuration	30
Fibre Channel Switched Fabric Configuration	30
Discovery Mode	30
Host Device Configuration	30
Logical Unit Management	31
Buffered Tape Writes	33
3 Visual Manager User Interface	35
Visual Manager Menu Tree	37
Main Menu	37
Visual Manager Access	38
Visual Manager Best Practices	40
Main Menu	41
System Menu	44
Serial Configuration	46
Network Configuration	47
Port Configuration - Ethernet Settings (Service Mode - Restricted Access)	48
SNMP Configuration	49
Active Fabric Configuration	50
User Configuration	51
Real-Time Clock Configuration	52
Reset Menu	53

Ports Menu	54
Fibre Channel Port Configuration	56
SCSI Bus Configuration.	60
Discovery Menu	64
Mapping Menu	65
Common Fibre Channel and SCSI Mapping Tasks	66
Fibre Channel Mapping Tasks	67
SCSI Mapping Tasks	71
Statistics Menu	74
Utilities Menu	75
FTP Utility Access	77
Trace Settings Configuration	79
Current, Previous, and Last Assert Trace Displays	81
Clear Current Traces and Clear Assert Traces.	82
Event Log Configuration	83
Event Log Display	84
Clear Event Log	85
Report Menu	86
Reboot Option.	87
4 Serial/Telnet User Interface89
Serial/Telnet Menu Tree	91
Main Menu	91
Telnet UI Access.	92
Serial UI Access	92
Power up Messages	94
Serial/Telnet UI Main Menu.	95
Configuration Menu	96
Baud Rate Configuration	97
Ethernet Configuration.	98
Fibre Channel Configuration	101
Parallel SCSI Configuration.	105
Device Mapping.	108
Trace and Event Settings Configuration	124
Real-Time Clock Configuration.	127
Active Fabric Configuration	128
Save Configuration.	128
Restore Last Saved Configuration	129

Reset and Save Configuration to Factory Defaults	129
System Utilities Menu	130
System Statistics.	131
Event Log.	139
Trace Dump Menu	140
Saving Copies of the Trace Buffers using FTP	140
Reboot Option.	142
Download New Firmware Option	142
5 FTP User Interface	145
Access the FTP User Interface (UI)	146
Backup and Restore Configuration Settings.	146
Backing up the Router Configuration	147
Restoring the Router Configuration.	148
Copy Trace Buffers.	149
Upgrade Firmware	150
6 Basic Troubleshooting	151
LED Indicators	153
Basic Troubleshooting	155
Verifying SCSI Bus Configuration	155
Verifying Fibre Channel Port Connection	156
Verifying SCSI Devices in Windows NT	157
Verifying the Router Configuration.	157
Verifying Mapping.	157
Verifying Devices	157
Verifying the Host Configuration	158
Verifying HBA Device Driver Information.	158
Verifying Serial Port Configuration.	158
Verifying PRLI Data	159
Introducing HP StorageWorks Library and Tape Tools.	160
Software Features.	160
Finding Additional Information.	162
Getting Support	162

A	Serial and Ethernet Pin Assignments	163
	RJ-11 Serial Pin Assignments	164
	RJ-45 Ethernet Cable Pin Assignments	165
B	Controller LUN Commands	167
	General Commands	168
	Report LUNs Command	168
	Inquiry Command	169
C	Addressing Methods and Table Structures	173
	SCC (SCSI Controller Command) Addressing Method	176
	Auto Assigned Addressing Method	176
	Indexed Addressing Method	177
D	Regulatory Compliance Notices	179
	Federal Communications Commission Notice	179
	Class A Equipment	180
	Class B Equipment	180
	Canadian Notice (Avis Canadien)	182
	Class A Equipment	182
	Class B Equipment	182
	European Union Notice	182
	Japanese Notice	183
	BSMI Notice	184
	Laser Device	184
	Laser Safety Warnings	184
	Compliance with CDRH Regulations	184
	Compliance with International Regulations	185
	Laser Product Label	185
	Laser Information	185
E	Electrostatic Discharge	187
	Grounding Methods	188
	Index	189



about this guide

This user guide provides information to help you:

- Install the Network Storage Router
- Configure the Network Storage Router
- Troubleshoot the Network Storage Router

About this Guide topics include:

- [Overview](#), page 10
- [Conventions](#), page 11
- [Rack Stability](#), page 13
- [Getting Help](#), page 14

Overview

This section covers the following topics:

- [Intended Audience](#)
- [Prerequisites](#)
- [Related Documentation](#)

Intended Audience

This guide is intended for administrators with a moderate knowledge level about network environments.

Prerequisites

Before you install this product, make sure you consider the items below.

- Knowledge of operation system
- Knowledge of related hardware/software
- Previous version of the product/firmware

Related Documentation

In addition to this guide, HP provides corresponding information:

- *Fibre Channel Physical and Signaling Interface (FC-PH)*, ANSI X3T9.3/Project 755D/Rev. 4.3, Contact: Global Engineering, 1-800-854-7179
- Fibre Channel Protocol for SCSI (FCP) Revision 12
- Fibre Channel Private Loop Direct Attach (FC-PLDA)
- *Fibre Channel Arbitrated Loop (FC-AL)*, ANSI X3T11/Project 960D/Revision 4.54, Contact: Globe Engineering, 1-800-854-7179
- *Gigabit Interface Converter (GBIC)*, Small Form Factor. SFF-8053, Revision 5.X
- *Common FC-PH Feature Sets Profiles*, Fibre Channel Systems Initiative, FCSI-101 Revision 3.1
- *SCSI Profile*, Fibre Channel System Initiative, FCSI-201-Revision 2.2
- *FCSI IP Profile*, Fibre Channel System Initiative, FCSI-202-Revision 2.1

Conventions

Conventions consist of the following:

- [Document Conventions](#)
- [Text Symbols](#)
- [Equipment Symbols](#)

Document Conventions

The document conventions included in [Table 1](#) apply in most cases.

Table 1: Document Conventions

Element	Convention
Cross-reference links	Figure 1
Key and field names, menu items, buttons, and dialog box titles	Bold
File names, application names, and text emphasis	<i>Italics</i>
User input, command and directory names, and system responses (output and messages)	Monospace font COMMAND NAMES are uppercase monospace font unless they are case sensitive
Variables	<monospace, italic font>
Features that are “service-mode restricted access,” or currently not supported.	(service mode-restricted access) (settings not supported)
Website addresses	Underlined sans serif font text: http://www.hp.com

Text Symbols

The following symbols may be found in the text of this guide. They have the following meanings.



WARNING: Text set off in this manner indicates that failure to follow directions in the warning could result in bodily harm or death.



Caution: Text set off in this manner indicates that failure to follow directions could result in damage to equipment or data.

Note: Text set off in this manner presents commentary, sidelights, or interesting points of information.

Equipment Symbols

The following equipment symbols may be found on hardware for which this guide pertains. They have the following meanings.



Any enclosed surface or area of the equipment marked with these symbols indicates the presence of electrical shock hazards. Enclosed area contains no operator serviceable parts.

WARNING: To reduce the risk of personal safety from electrical shock hazards, do not open this enclosure.



Any RJ-45 receptacle marked with these symbols indicates a network interface connection.

WARNING: To reduce the risk of electrical shock, fire, or damage to the equipment, do not plug telephone or telecommunications connectors into this receptacle.



Any surface or area of the equipment marked with these symbols indicates the presence of a hot surface or hot component. Contact with this surface could result in injury.

WARNING: To reduce the risk of personal safety from a hot component, allow the surface to cool before touching.



Power supplies or systems marked with these symbols indicate the presence of multiple sources of power.

WARNING: To reduce the risk of personal safety from electrical shock, remove all power cords to completely disconnect power from the power supplies and systems.



Any product or assembly marked with these symbols indicates that the component exceeds the recommended weight for one individual to handle safely.

WARNING: To reduce the risk of personal safety or damage to the equipment, observe local occupational health and safety requirements and guidelines for manually handling material.

Rack Stability

Rack stability protects personnel and equipment.



WARNING: To reduce the risk of personal safety or damage to the equipment, be sure that:

- The leveling jacks are extended to the floor.
 - The full weight of the rack rests on the leveling jacks.
 - In single rack installations, the stabilizing feet are attached to the rack.
 - In multiple rack installations, the racks are coupled.
 - Only one rack component is extended at any time. A rack may become unstable if more than one rack component is extended for any reason.
-

Getting Help

If you still have a question after reading this guide, contact an HP authorized service provider or access our website: <http://www.hp.com>.

HP Technical Support

In North America, call technical support at 1-800-652-6672, available 24 hours a day, 7 days a week.

Note: For continuous quality improvement, calls may be recorded or monitored.

Outside North America, call technical support at the nearest location. Telephone numbers for worldwide technical support are listed on the HP website under support: <http://www.hp.com/support>.

Be sure to have the following information available before calling:

- Technical support registration number (if applicable)
- Product serial numbers
- Product model names and numbers
- Software application name and version
- Applicable error messages
- Operating system type and revision level
- Detailed, specific questions

HP Storage Website

The HP website has the latest information on this product, as well as the latest drivers. Access storage at: <http://www.hp.com>. From this website, select the appropriate product or solution.

HP Authorized Reseller

For the name of your nearest HP authorized reseller:

- In the United States, call 1-800-345-1518
- In Canada, call 1-800-263-5868
- Elsewhere, see the HP website for locations and telephone numbers:
<http://www.hp.com>.

Introduction

1

The HP StorageWorks Network Storage Router provides bidirectional connectivity for Narrow/Wide Fast/Ultra-3 SCSI buses in a Fibre Channel Switched Fabric (FC-SW) environment.

This chapter introduces the following topics:

- [External Features Overview](#), page 18
 - Power Indicator
 - Serial Port
 - Ethernet Port
 - Fibre Channel Port
 - SCSI Buses
- [Functional Overview](#), page 20
 - Fibre Channel to SCSI Protocol Process
 - SCSI to Fibre Channel Protocol Process
 - LAN-free Backup and Restore
- [Router Specifications](#), page 23
 - Operating Environmental Requirements
 - Shipping and Storing Environmental Requirements
 - Power Requirements

External Features Overview

Figure 1 illustrates the I/O panel of the router.

Figure 1: Router illustration

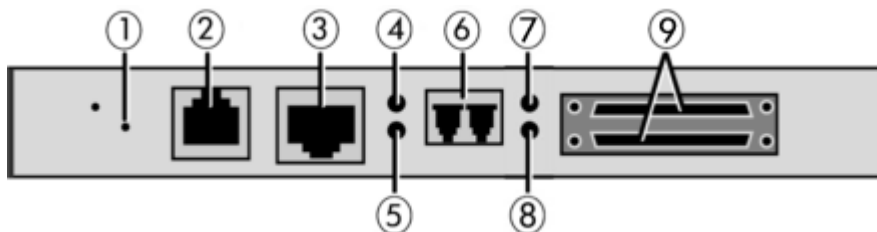

Table 2: Router illustration components

Item	Description
①	Power LED
②	Serial RJ-11 connector
③	Ethernet RJ-45 connector
④	Fibre Channel activity LED
⑤	Fibre Channel link LED
⑥	Fibre Channel Port
⑦	SCSI bus activity LED (on corresponding port)
⑧	SCSI bus activity LED (on corresponding port)
⑨	SCSI VHDCI connector (2)

Power Indicator

The router has one power LED. Power indicator LED definition:

Green - Power has been applied to this module

Yellow - Power-On-Self-Test (POST) in process or processor problems

Serial Port

The router is equipped with one serial port. See [Figure 1](#) for the location of the serial port.

The serial port can be used to access the Serial/Telnet user interface, which is used to locally manage and configure the router.

Ethernet Port

One Ethernet port with an LED indicator is included in the router. See [Figure 1](#) for the location of the Ethernet port. Ethernet port LED definition:

Activity - Port activity

Link - Valid Ethernet link

Fibre Channel Port

One Fibre Channel port with LED indicators is included in the router. See [Figure 1](#) for the location of the Fibre Channel port. Fibre Channel LED definition:

Green (ACT) - Fibre Channel port activity

Green (LINK) - Valid Fibre Channel link

SCSI Buses

Two SCSI buses with LED indicators are included in the router. See [Figure 1](#) for the location of the SCSI buses. SCSI bus LED definition:

Green - SCSI bus activity on corresponding port

Functional Overview

The router translates the Fibre Channel Protocol (FCP) to and from the SCSI Protocol. It transfers commands, data, and status information to and from Fibre Channel controllers and SCSI devices.

Supported devices include:

- Initiator Devices – Fibre Channel and SCSI hosts
- Direct Access Devices – RAID Controllers, disk drives, JBODs
- Sequential Access Devices – Tape drives
- Changer Devices – Tape and Magneto-Optical Libraries

The router provides multiple Fibre Channel to SCSI I/O configurations.

A sample configuration is illustrated in [Figure 2](#).

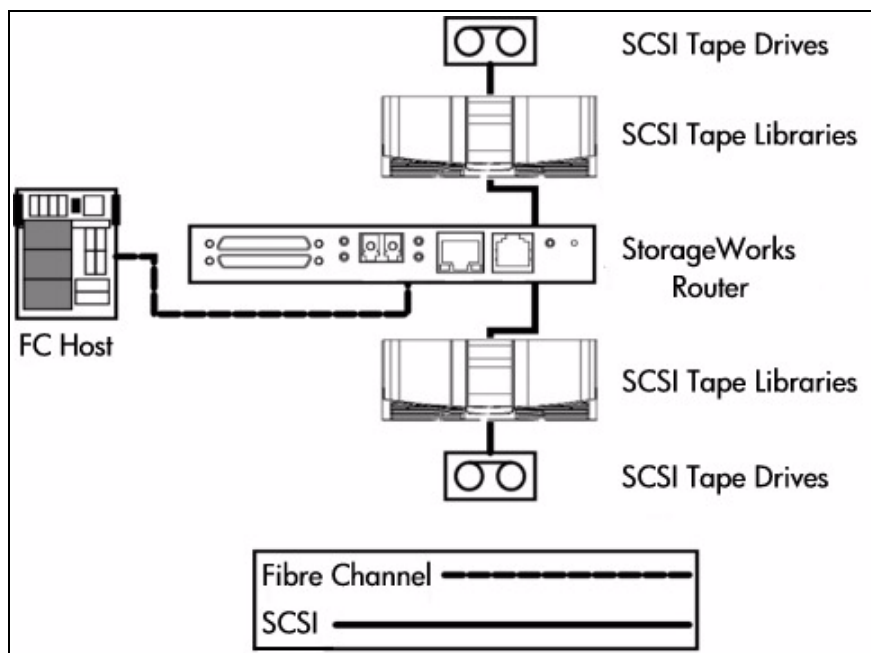

Figure 2: Example configuration

Fibre Channel to SCSI Protocol Process

This section describes the steps the router uses to convert Fibre Channel host protocol to SCSI device protocol. [Figure 3](#) and [Table 3](#) illustrate and define this process.

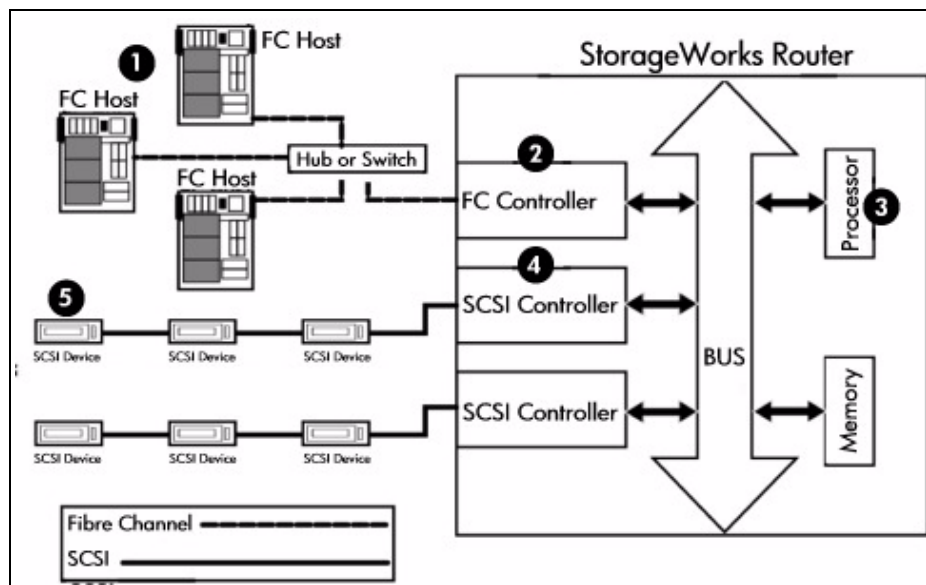

Figure 3: Converting Fibre Channel to SCSI process

Table 3: Converting Fibre Channel to SCSI

Item	Description
①	A Fibre Channel host issues an encapsulated FCP protocol command packet to the router.
②	The router Fibre Channel controller interprets the Fibre Channel information, and places the packet in buffer memory.
③	The router interprets the Fibre Channel information packet and programs the router SCSI controller to process the transaction.
④	The router SCSI controller sends the command to the SCSI device (target).
⑤	The SCSI target interprets the command and executes it.

SCSI to Fibre Channel Protocol Process

In this example, a SCSI host (initiator) on the SCSI bus issues commands and the information is passed through the router to a target on the Fibre Channel Storage Area Network (FC-SAN). [Figure 4](#) is an illustration of the process and [Table 4](#) defines each step.

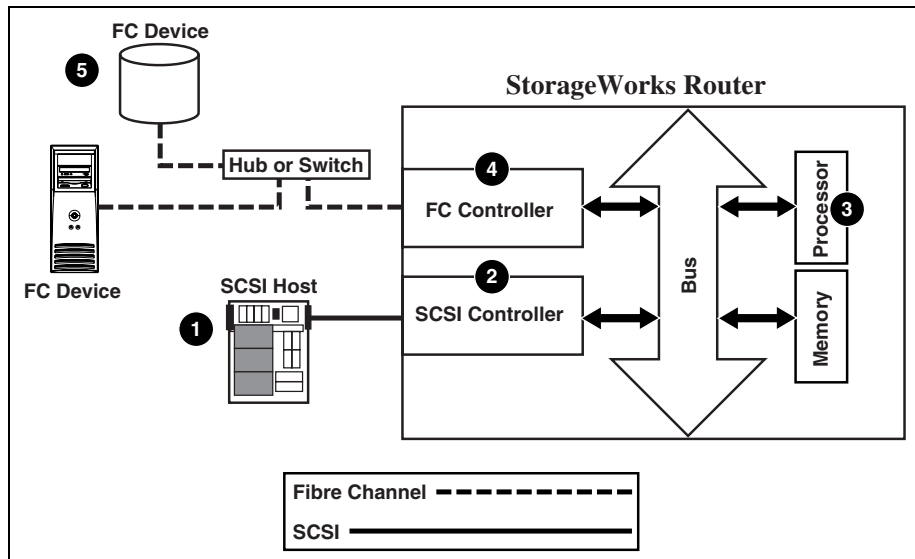

Figure 4: Converting SCSI to Fibre Channel Protocol Process

Table 4: Converting SCSI to Fibre Channel Protocol

Item	Description
①	A SCSI host issues a command to the router.
②	The SCSI controller in the router interprets the command and places it in buffer memory.
③	The router processor interprets data and programs the router Fibre Channel controller to process the transaction.
④	The router Fibre Channel controller translates data into an FCP protocol packet and sends it to the Fibre Channel target.
⑤	The Fibre Channel target interprets the FCP protocol packet and executes the command.

LAN-free Backup and Restore

The router can enable LAN-free backup/restore to allow the bulk of data traffic to be moved from the LAN to the storage area network (SAN).

See [Figure 5](#) for an illustration of this process.

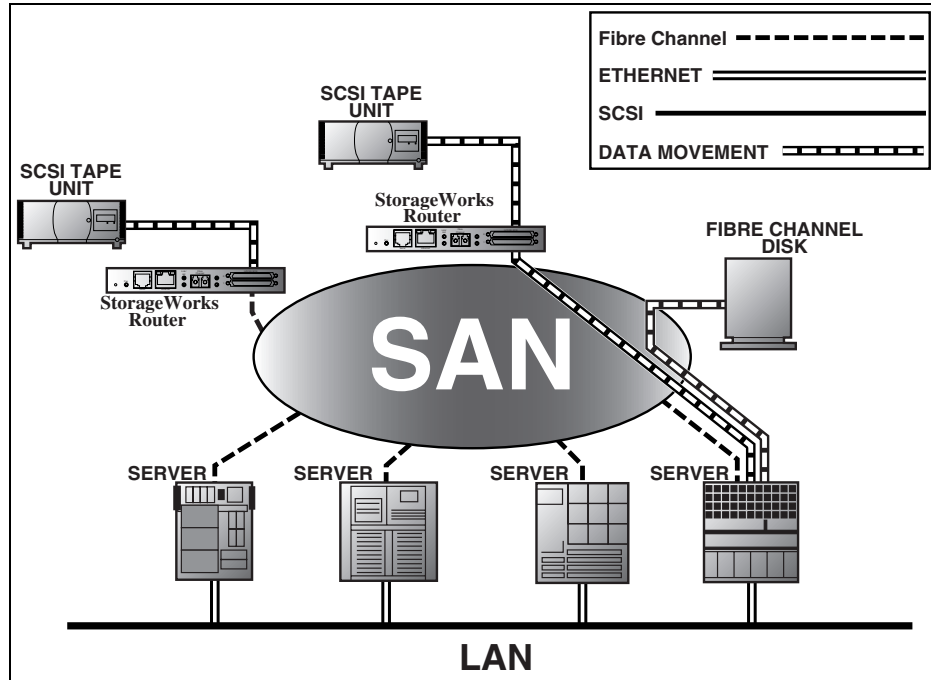

Figure 5: LAN-free backup and restore

Router Specifications

This section lists the environmental requirements of the router.

Operating Environmental Requirements

- Temperature: 0 to 50°C
- Relative Humidity: 5 to 80% (non-condensing)

Shipping and Storing Environmental Requirements

- Temperature: -40 to +55°C
- Relative Humidity: 0 to 92% (non-condensing)

Power Requirements

- VDC: 3V and 5V
- 25 watt maximum power dissipation

Configuration Overview

2

The HP StorageWorks Network Storage Router can be configured and managed using several user interfaces (UI). Each UI is introduced in this chapter, along with information about common configuration settings. Included are:

- [Router Default Ethernet Settings](#), page 26
- [UI Overview](#), page 27
- [Common Configuration Settings](#), page 29
 - Controller LUN Commands
 - SCSI Bus Configuration
 - Default Fibre Channel Port Configuration
 - Fibre Channel Switched Fabric Configuration
 - Discovery Mode
 - Host Device Configuration
 - Logical Unit Management
 - Buffered Tape Writes

Note: Before attempting to configure the router, a basic understanding of Fibre Channel and SCSI devices is recommended. For information on SCSI standards, refer to publications from the X3T10 committee of ANSI (American National Standards Institute). For information on Fibre Channel standards, refer to publications from the X3T11 committee of ANSI. For those who are interested in purchasing approved American National Standards and Technical Reports, contact ANSI at (212) 642-4900.

Router Default Ethernet Settings

Some of the basic factory default values are:

- IP address: `http://1.1.1.1/`
- Subnet mask: `255.255.255.0`
- Gateway address: `0.0.0.0`
- User name: `root`
- Password: `password`

HP recommends that you change these values from the defaults.

All settings within the router configuration are preset with default values. These values are set to allow the router to be installed into most HP environments with little or no configuration changes.

After changing the basic default values listed above, carefully consider any additional configuration changes.

After the initial configuration of the router is established, HP recommends backing up the configuration to an external file. If needed, during a recovery process, this file can then be restored back onto the router.

UI Overview

The router supports the following user interfaces:

- Visual Manager
- Serial
- Telnet
- FTP

Visual Manager

Visual Manager lets you view and change router configuration from any standard Web browser. Information is dynamically generated in an HTML format so that any Web browser can access it.

Unless the default values are used, the 10/100BaseT Ethernet port must be configured using the serial port with an appropriate IP address, subnet mask, and gateway prior to use.

For complete information on accessing and using Visual Manager, see Chapter 3, "[Visual Manager User Interface](#)."

Serial

The serial port allows for configuration of device characteristics from a terminal or terminal emulator. Multiple serial connections cannot be run at the same time.

For complete information on accessing and using the Serial UI, see Chapter 4, "[Serial/Telnet User Interface](#)."

Telnet

From most Microsoft® Windows® 9x, Windows NT®, and Windows 2000® systems, users can start a Telnet session from the DOS (command) shell after the IP address has been set.

For complete information on accessing and using the Telnet UI, see Chapter 4, "[Serial/Telnet User Interface](#)."

FTP

The router supports the use of the FTP UI to perform several copy procedures using the `put` and the `get` commands.

For more information, see Chapter 5, "[FTP User Interface](#)."

Common Configuration Settings

To provide connectivity between hosts and devices, the router must establish an address on each connected Fibre Channel network and SCSI bus. The following paragraphs discuss configuration settings that are commonly modified and are available in the Visual Manager UI and the Serial/Telnet UI.

For procedural information on accessing and changing these settings, see Chapter 3, "[Visual Manager User Interface](#)," and Chapter 4, "[Serial/Telnet User Interface](#)."

Controller LUN Commands

The router supports a set of SCSI-3 commands that can be received as FCP commands over the Fibre Channel port. These commands provide support for value added features such as Extended Copy (a future value added option). When using these commands, they must be sent to the Controller LUN.

For more information, see Appendix B, "[Controller LUN Commands](#)."

SCSI Bus Configuration

The router can appear on a SCSI bus as a pair of initiators. The primary Initiator ID can be set to any valid SCSI address (0-15) and is used for most traffic. The alternate Initiator ID can also be set to any valid SCSI address (0-15) and is for use with high priority traffic. The Initiator IDs (primary and alternate) should not be set to the same SCSI address and no other devices on the SCSI bus may use either of these SCSI addresses.

The router can also appear as one or more Target ID on a SCSI bus. By default, no Target IDs are set up.

The router provides the capability to reset SCSI buses during the router boot cycle. This allows devices on a SCSI bus to be in a known state. The reset option can be enabled/disabled during configuration of the router. The SCSI bus reset feature is enabled in the default configuration, but should be disabled for configurations using multiple initiators, tape changers or other devices that have long reset cycles, or for environments that are adversely affected by bus resets.

The router negotiates the maximum values for transfer rates and bandwidth on a SCSI bus. If an attached SCSI device does not allow the full rates, the router will use the best rates it can negotiate for that device. Because negotiation is on a device-specific basis, the router can support a mix of SCSI device types on the same SCSI bus.

Fibre Channel Port Configuration

By default, the configuration of the Fibre Channel ports is set to N_Port, forcing the router to negotiate a fabric only mode.

Note: By default, the Fibre Channel port speed is set to 2 Gb/s. Changes to the Fibre Channel port speed must be manually set, such as for 1 Gb/s. If set incorrectly and the router is plugged into a Loop or Fabric, the unit may receive framing errors, which can be found in the trace logs, and the fiber link light will be off because of the incorrect Fibre Channel link speed. For more information on manually setting the Fibre Channel port speed, see Chapter 3, "[Fibre Channel Port Configuration](#)."

Fibre Channel Switched Fabric Configuration

When connected to a Fibre Channel switch, the router is identified to the switch as a unique device by the factory programmed World Wide Name (WWN).

Discovery Mode

This feature makes it easy to discover attached Fibre Channel and SCSI target devices and automatically map them on the host side for the bus/port in question.

There are two discovery methods available:

- Manual discovery
- Auto discovery

Auto Discovery can be set to occur after reboot events (when the router reboots) or link-up events (for instance, when cables are attached or a hub is rebooted). Auto Discovery can be disabled by setting the router to Manual Discovery.

For more information on setting the Discovery Mode, see Chapter 3, "[Fibre Channel Port Configuration](#)," when using the Visual Manager User Interface or Chapter 4, "[Fibre Channel Configuration](#)," when using Serial/Telnet.

Host Device Configuration

A host system using a Fibre Channel Host Bus Adapter (HBA) will typically map devices into the existing device-mapping scheme used by that operating system. Refer to the HBA manual for the mapping table.

Mapping involves pairing FC_AL_PA to SCSI target address. The HBA will claim enough SCSI bus entries to allow up to 125 Fibre Channel targets to be mapped to SCSI Bus: Target entries. This is usually done by a fixed mapping of AL_PA to Bus: Target. In such a configuration, the router corresponds to a Bus: Target identifier, with the attached SCSI devices appearing as logical units (LUNs). Operating systems can extend the available SCSI limit of 15 targets per bus. Although this is not an issue for the operating system or most applications, there are cases where older applications can have expectations about what constitutes a valid SCSI ID, and thus may not correctly handle certain mappings. In particular, some applications may exhibit difficulties addressing target IDs greater than 15 (for example, 16 and up). This situation can be resolved by configuring the router to use hard addressing and setting the AL_PA to a value less than 16 that the HBA will be able to map.

For example, depending on the Fibre Channel HBA, if the hard AL_PA selection is 1, then the address is 1. If the selection is 125, the AL_PA address is 0xEF. Some Fibre Channel HBAs will map devices differently, so verify the AL_PA by reviewing the documentation for the HBA.

For more information on AL_PA configuration, see Chapter 3, "[Fibre Channel Port Configuration](#)," when using the Visual Manager User Interface or Chapter 4, "[Fibre Channel Configuration](#)," when using Serial/Telnet.

Logical Unit Management

Because SAN resources can be shared, it is possible for multiple hosts to have access to the same devices on the SAN. To prevent conflicts, the router provides LUN management as a means to restrict device access to certain hosts. LUN management goes beyond simple LUN masking, to prevent gaps in the list of LUNs presented to a host.

LUN management maps can be created for different views of the devices attached to the router. Each Fibre Channel host is assigned a specific map configuration. Not only can the administrator control which devices a host may access, but also which LUNs are used to access these devices.

For a Fibre Channel host, a map is a table of LUNs, where each entry is either empty or contains device address information needed for host/device communication.

For a SCSI host, a map contains a list of target IDs, each of which has its own table of LUNs with address information needed for host/device communication.

Note: The router can respond to multiple Target IDs on a SCSI bus.

Both Fibre Channel ports and SCSI buses have predefined maps.

There are four predefined maps:

- Indexed Map
- Port 0 Device Map
- Auto Assigned Maps
- SCC Map

When a host sends a command, the router will select which map to use, based on the port receiving the command and the ID of the host sending the command. For Fibre Channel ports, the host ID is the World Wide Name; for SCSI buses, the host ID is the Initiator ID (0 - 15). When a host is unknown or is not assigned a specific map, the router will use the default map.

Indexed Map

An indexed map is initially empty.

Port 0 Device Map

The Port 0 Device Map should be used when editing and assigning oncoming hosts.

Auto Assigned Map

An auto assigned map is built dynamically and contains all of the devices found during discovery. This map will change automatically any time the discovery process finds a change in the devices attached. This map cannot be modified by the user.

SCC Map

An SCC map is only available on Fibre Channel ports and contains only a single entry for LUN 0. This LUN is a router controller LUN. Access to attached devices is managed using SCC logical unit addressing.

Buffered Tape Writes

This option is designed to enhance system performance by returning status on consecutive write commands prior to the tape device receiving data. If data does not transfer correctly, the router returns a check condition on a subsequent command.

Commands other than Write are not issued until status is received for any pending Write, and status is not returned until the device completes the command. This sequence is appropriate for tasks such as file backup or restore.

Some applications require confirmation of individual blocks being written to the medium, such as for audit trail tapes or log tapes. In these instances, the Buffer Tape Writes option must be disabled.

Visual Manager User Interface

3

The HP StorageWorks Visual Manager user interface (UI) provides a graphical format that is used to remotely view and change router configurations. Use the Microsoft Internet Explorer or Netscape (version 6.2 or greater) Web browsers to access Visual Manager.

Information is presented in HTML format in accordance with the W3C specification for HTML 3.2. Current W3C recommendations and other technical documents can be found at www.w3.org/TR/.

This chapter describes the menus and tasks of the Visual Manager UI and is organized using the same structure as the Visual Manager UI:

- [Visual Manager Menu Tree](#), page 37
- [Visual Manager Access](#), page 38
- [Visual Manager Best Practices](#), page 40
- [Main Menu](#), page 41
- [System Menu](#), page 44
 - Serial Configuration
 - Network Configuration
 - [SNMP Configuration \(not supported\)](#)
 - Active Fabric Configuration
 - User Configuration
 - Real-Time Clock Configuration
 - Reset Menu

- [Ports Menu](#), page 54
 - Fibre Channel Port Configuration
 - SCSI Bus Configuration
- [Discovery Menu](#), page 64
- [Mapping Menu](#), page 65
 - Common Fibre Channel and SCSI Mapping Tasks
 - SCSI Mapping Tasks
- [Statistics Menu](#), page 74
- [Utilities Menu](#), page 75
 - FTP Utility Access
 - Trace Settings Configuration
 - Current, Previous, and Last Assert Trace Displays
 - Clear Current Traces and Clear Assert Traces
 - Event Log Configuration
 - Event Log Display
 - Clear Event Log
- [Report Menu](#), page 86
- [Reboot Option](#), page 87

Visual Manager Menu Tree

Main Menu

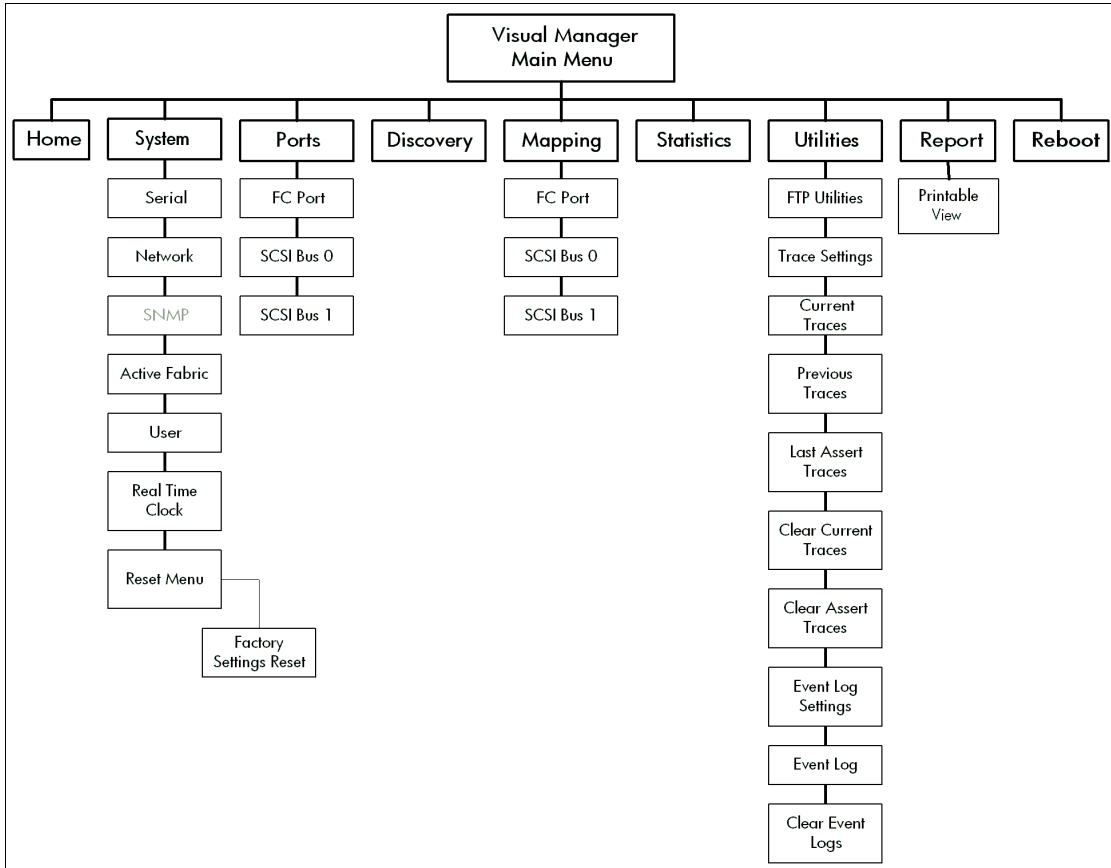

Figure 6: Visual Manager Main menu tree

Visual Manager Access

Visual Manager (VM) can be accessed from any standard Web browser:

1. Connect a 10/100BaseT Ethernet cable to the back of the router.
2. Apply power to the connected SCSI and/or Fibre Channel devices.
3. Apply power to the host computer.
4. Enter the router IP address in the address field of the Web browser of the host computer.

Note: To access VM, the router must be assigned a valid IP address. The factory default setting for the IP address allows access on a local area network only. If the factory default for the IP address is already used by another device on the local network, the IP address must be changed.

The factory default for the IP address is `http://1.1.1.1/`

Note: If the IP address of the router is not known or needs to be changed, connect to the router using a serial connection. The current router IP address is displayed and can be changed in the serial Ethernet Configuration Menu.

The Visual Manager home page is displayed, showing router status information. The home page is accessible to anyone who knows the router IP address.

5. Select the desired menu option to access menus and screens.

The Password dialog box is displayed. See [Figure 7](#) for an example of the Password Dialog box.

6. Enter the authorized user name and password. The username and password are case-sensitive.

The default user name is `root` and the default password is `password`.



Figure 7: Password Dialog Box

Note: HP recommends changing the user name and password from the defaults.

Note: To end the current session of VM, the browser window must be closed. Navigating the browser to another URL does not end the current session.

Visual Manager Best Practices

The following recommendations should be observed:

- A standard keyboard and mouse must be used to navigate in the VM.
- The router is shipped with a configuration of default settings that is acceptable for most system environments. Few changes to the configuration should be necessary.
- After any configuration changes are made, depending on the menu option, select **Submit** or **Configure** to send changes from the Web browser to the router.

Changes will take effect during the next router reboot cycle.

- If the configuration has been modified to meet specific needs, back up the configuration to an external file. If necessary, these settings can later be restored to the router.
- Except for the user name, password, and override access, fields are not case sensitive.
- HP recommends that you not bookmark VM pages with the Web browser.
Because configuration information is transmitted via URLs, it is possible that the router could be configured with information present at the time a page was bookmarked.
- HP recommends navigating using only the Web page links contained in VM itself.

Depending on the Web browser used, these links will often appear as highlighted text. By selecting these links, VM can be safely navigated.

Main Menu

The Main Menu home page is displayed whenever VM is accessed.

The home page contains status information, including a physical image of the router.

Figure 8 is an example of the home page.

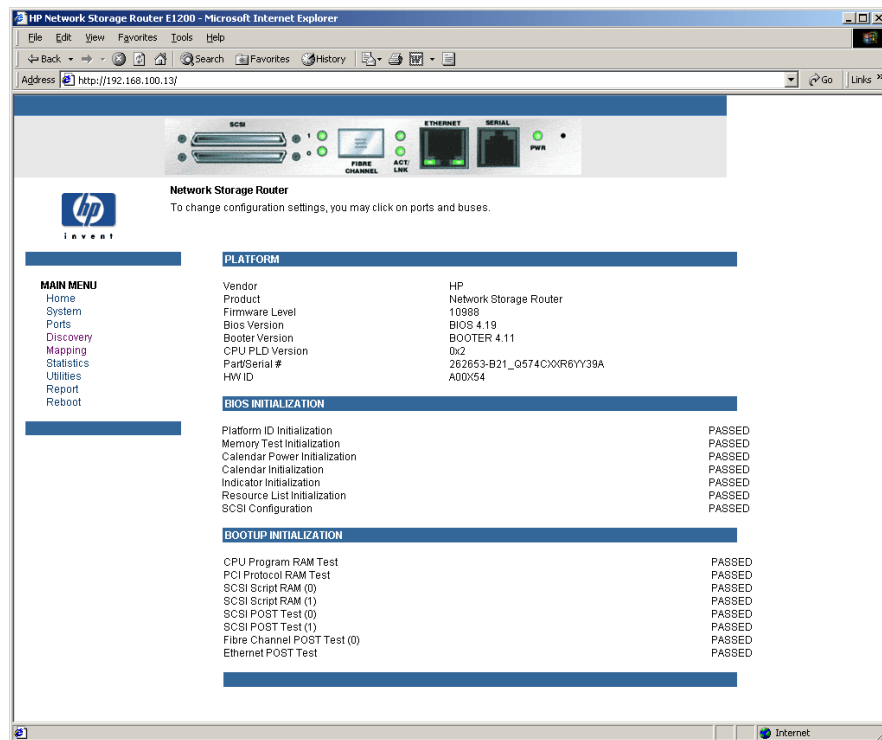

Figure 8: Visual Manager Home page

Home page information includes:

- The HP logo is located in the upper left corner of the page. [Figure 9](#) is an example of this portion of the home page screen. If the Internet is accessible to the host, click the HP logo to open the website.



Figure 9: HP logo

- An illustration of the router is located near the top of the home page. [Figure 10](#) is an example of this portion of the home page screen.



Figure 10: Router image

- The router image is interactive, allowing quick access to configuration menus:
 - To display current settings and status for a port, click the corresponding port shown in the router image.
 - To open a menu for making changes to the configuration for that particular port or bus, click the desired Fibre Channel port or SCSI bus.
 - To open the Network Configuration Menu, click the Ethernet port.
- Router status information is located in the body of the home page and includes platform information

- Main Menu options:
 - **Home** displays router status information.
 - **System** configures standard system components.
 - **Ports** configures the Fibre Channel port and SCSI buses.
 - **Discovery** displays devices and discovers new devices.
 - **Mapping** displays and configures maps.
 - **Statistics** displays router statistics.
 - **Utilities** configures utility settings.
 - **Report** displays system information.
 - **Reboot** restarts the router.

Each Main Menu option is discussed in the following sections of this chapter.

System Menu

The System Menu is accessed from the Main Menu and is used to view and configure serial, network, trap, active fabric, clock, and power supply components.

Figure 11 is an example of the System page.

Network Storage Router
To change configuration settings, you may click on ports and buses.

SERIAL		NETWORK	
Name	Status	Name	Status
Baud Rate	115200	MAC Address	00:ED:02:E2:09:53
		IP Address	192.168.100.25 (DHCP)
		Subnet Mask	255.255.255.0 (DHCP)
		IP Gateway	192.168.100.4
		Ethernet Mode	10/100Mbps
		DHCP Client	Enabled
		Hostname	Router

SNMP		TRAP MANAGER 1	
Name	Status	Name	Status
Community Get	public	IP Address	1.1.1.1
Community Set	private	Port	162
Traps	Disabled	Filter	Log All Events
		Row State	No Traps (1)

TRAP MANAGER 2		TRAP MANAGER 3	
Name	Status	Name	Status
IP Address	1.1.1.1	IP Address	1.1.1.1
Port	162	Port	162
Filter	Log All Events	Filter	Log All Events
Row State	No Traps (1)	Row State	No Traps (1)

ACTIVE FABRIC		REAL-TIME CLOCK	
Name	Status	Name	Status
Backup Mode	DISABLED	Date	Monday 2/10/2003
Controller LUNS	1	Time	14:08:52

Figure 11: System page

System page tasks:

- **Serial** configures the baud rate.
- **Network** configures Ethernet settings.
- **SNMP** is not supported.
- **Active Fabric** configures Active Fabric settings.
- **User** configures user security settings.

- **Real-Time Clock** configures system date and time.
- **Reset Menu**
 - **Factory Settings Reset** restores factory default settings.

Each menu option is discussed in the following paragraphs.

Serial Configuration

The Serial screen is used to change the baud rate for the serial port.

[Figure 12](#) is an example of the Serial screen.

If the Autobaud feature is being used, it may not be necessary to set the baud rate.

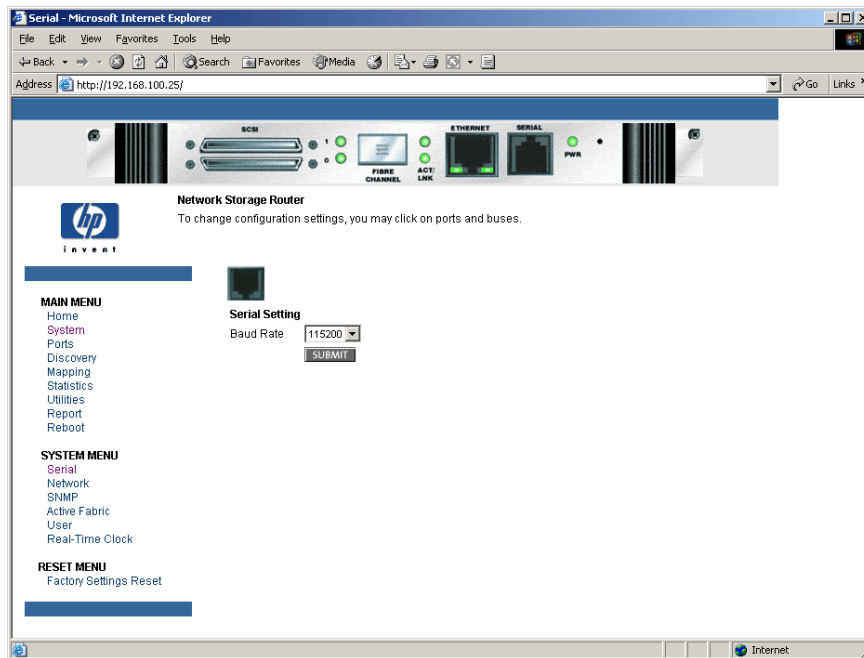

Figure 12: Serial screen

The current baud-rate setting is displayed.

Note: HP recommends setting the baud rate to 115200.

Network Configuration

The Network screen is used to enter network settings, including Ethernet settings. [Figure 13](#) is an example of the Network screen.

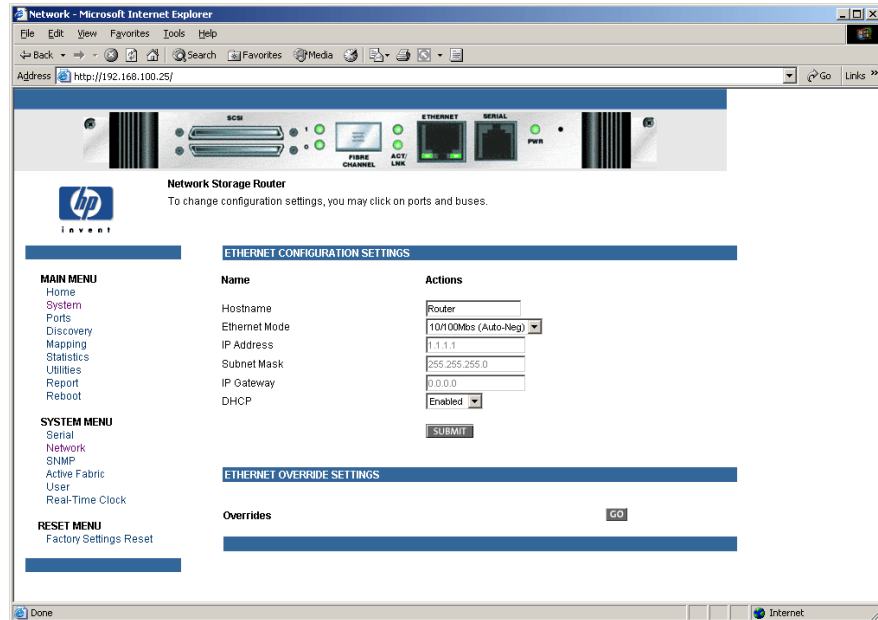

Figure 13: Network screen

Network Menu options:

- **Network Settings** changes the hostname.
- **Port Configuration** changes Ethernet configuration settings.

Each of these Network Menu options is discussed in the following sections.

Network Settings

To change the hostname, enter an alphanumeric entry of one word up to 8 characters in length. Then, select **Submit**.

Port Configuration - Ethernet Settings (Service Mode - Restricted Access)

To change the Ethernet configuration settings, select the Ethernet port icon. The Ethernet Configuration dialog box is displayed.

See [Figure 14](#) for an example of the Ethernet Configuration dialog box.

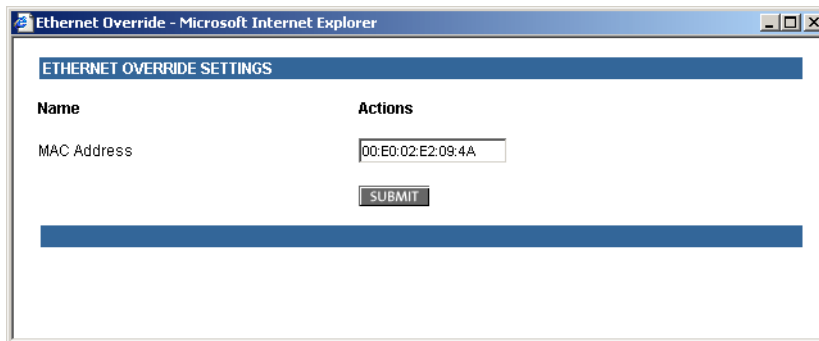

Figure 14: Ethernet Configuration dialog box

Ethernet configuration settings:

- **Ethernet Mode** can be set to one of the following options:
 - 10Mps Only
 - 100Mps (half duplex) Only
 - 100Mps (full duplex) Only
 - 10/100Mps (Auto-Neg.)
- **MAC address** is the Ethernet physical address of the router.



Caution: If this configuration is incorrectly set, processing difficulties may occur. Before changing this setting, evaluate the need for the change and verify the desired setting. HP recommends backing up the router configuration to an external file before making changes to this setting.

The Ethernet physical address is always assigned by the manufacturer.

- **IP address** (default: 1.1.1.1) is the IP address of the router.
- **Subnet Mask** (default: 255.255.255.0) is the IP subnet mask for the router.
- **IP Gateway** (default: 0.0.0.0) is the IP address of the gateway for the Ethernet network connected to the router.
- **DHCP** enables or disables support for Dynamic Host Configuration Protocol (DHCP).

When DHCP is enabled, the router requests a dynamic IP address from a DHCP server on the Ethernet network. The router must be rebooted before an IP address will be requested from the DHCP server. After the router is rebooted, the HTTP session must be restarted. The IP address will be different from the former non-DHCP IP address.

Note: To use the DHCP feature, a DHCP server must be operational on the Ethernet network. If the DHCP feature is used when there is not DHCP server, the standard for DHCP requires the router wait three minutes for a response from a DHCP server before timing out.

Some DHCP servers allow a lease reservation to be set up for an IP address by providing the server with the Ethernet MAC address. The DHCP server always provides the same IP address to the router. This setup can be useful for remote management of the router via Telnet or VM. Because the method of setting up a lease reservation varies, depending on the DHCP server being used contact the Network Administrator for assistance.

SNMP Configuration

SNMP configuration is not supported.

Active Fabric Configuration

The Active Fabric screen allows setup of Active Fabric options.

Figure 15 is an example of the Active Fabric screen.

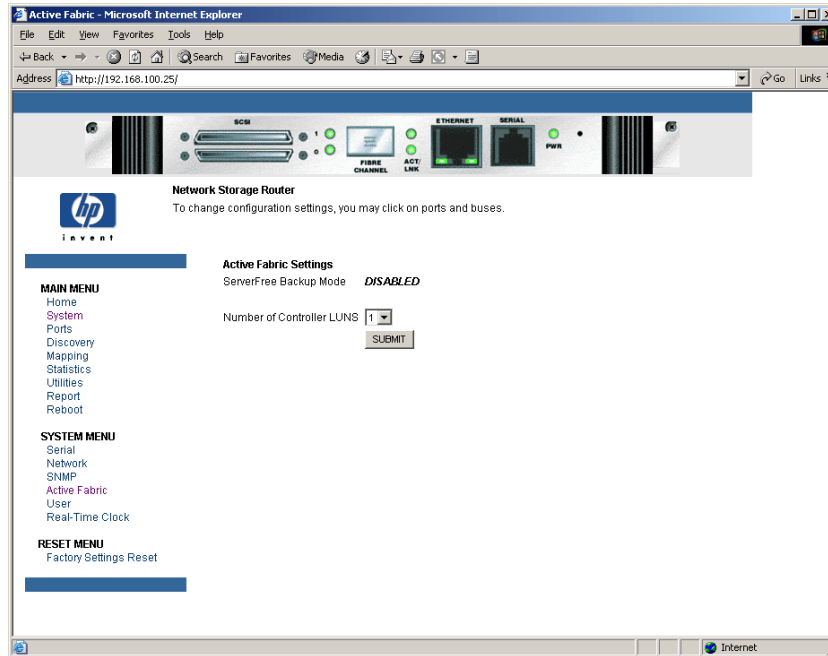

Figure 15: Active Fabric screen

Active Fabric settings:

- **Number of Controller LUNs** (default: 1) sets the number of controller LUNs reported by the router.

The number must be in the range of 0 through 4.

For information on controller LUN commands, see Appendix B, "[Controller LUN Commands](#)."

User Configuration

The User screen is used to set up router security.

Figure 16 is an example of the User screen.

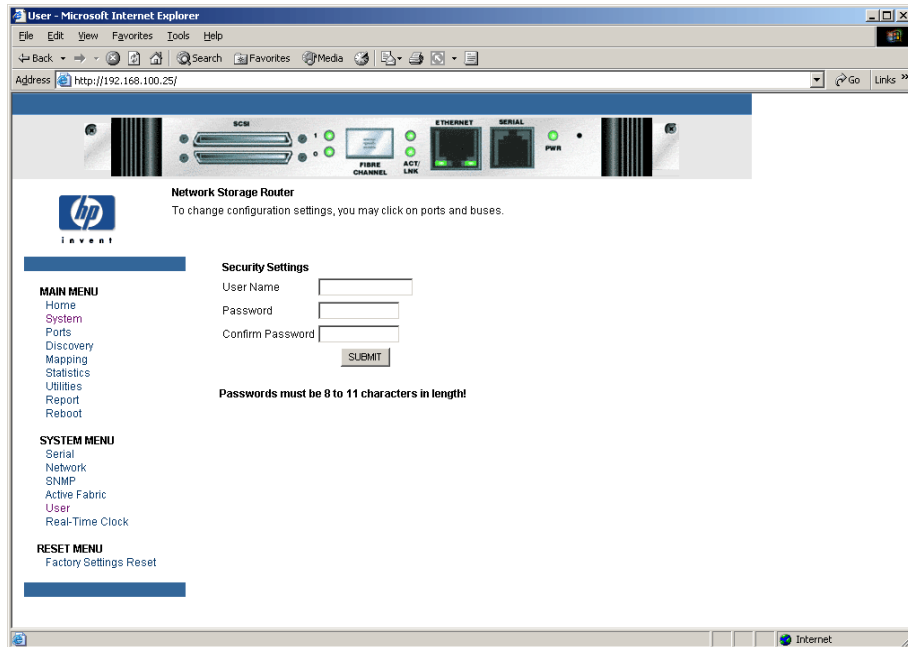

Figure 16: User screen: security settings

User settings:

- **User Name** (default: `root`) is any alphanumeric combination.
- **Password** (default: `password`) is any alphanumeric combination.

The user name and password should be unique and kept confidential. HP recommends using a combination of letters and numbers when creating the user name and password.

Note: These security settings affect all user interfaces of the router.

Real-Time Clock Configuration

The Real Time Clock screen is used to set the system time and date.

Figure 17 is an example of the Real-Time Clock screen.

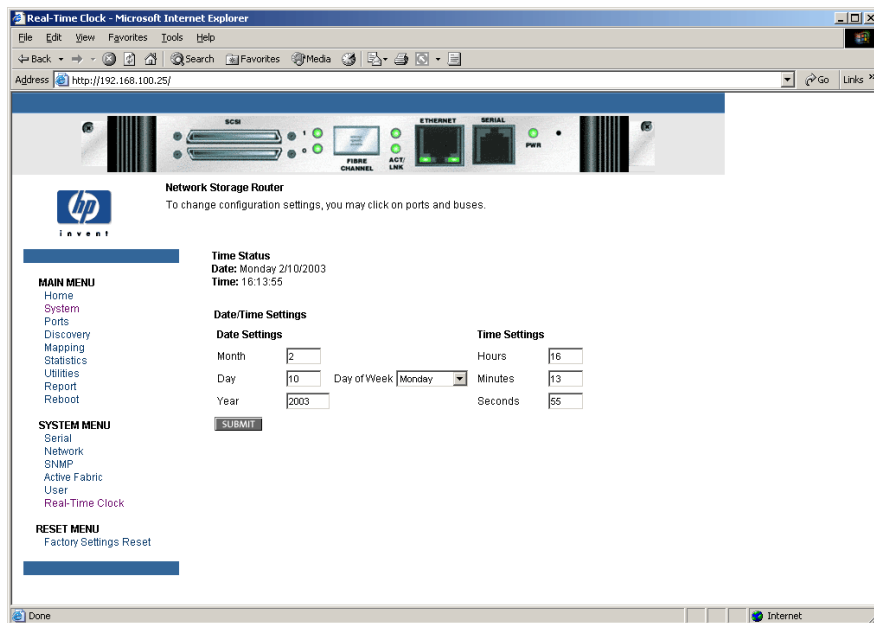

Figure 17: Real-Time Clock screen

Real-Time Clock settings:

- **Date Settings** sets the month, date, and year.
Use a four-digit number to represent the year.
- **Day of Week** sets the day of week.
- **Time Settings** sets the hours, minutes, and seconds.
The system clock is a 24-hour clock.

Reset Menu

The Reset Menu is used to reset the router to factory default settings.

Figure 18 is an example of the Reset Menu.

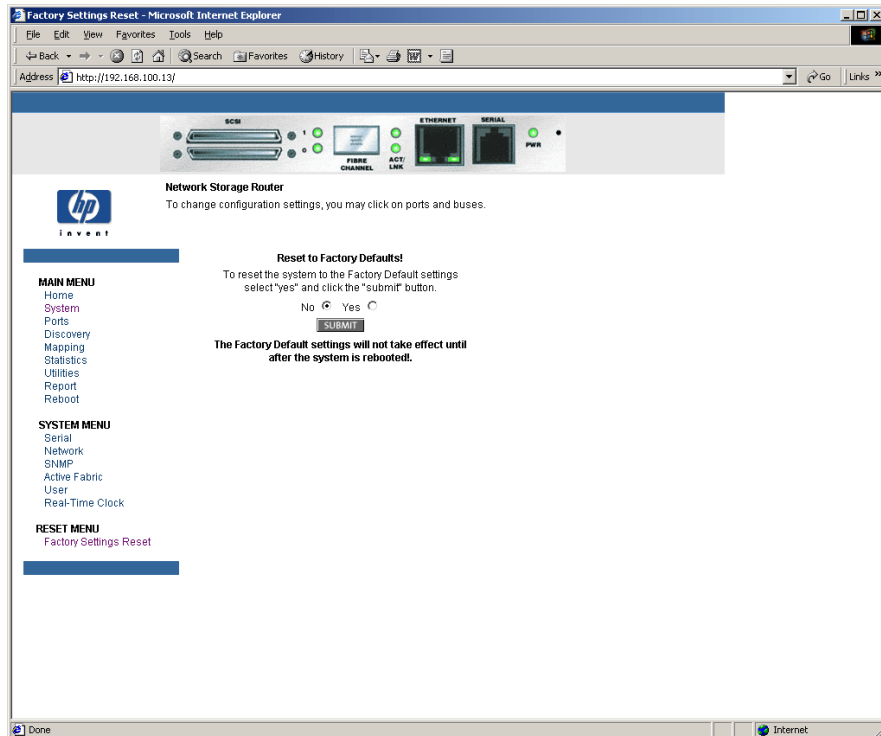

Figure 18: Reset to Factory Default screen

Current router activities are disrupted while the unit resets the configuration to the factory defaults and saves those options to FLASH memory.



Caution: Resetting the router configuration to the factory defaults will delete custom maps or map changes.

Note: Resetting to factory defaults through VM will not affect Ethernet connectivity. User-configured values for the IP address and gateway will be retained.

Ports Menu

Accessed from the Main Menu, the Ports Menu is used to view and to modify configuration settings of the Fibre Channel port and SCSI buses.

Figure 19 is an example of the initial Ports Menu.

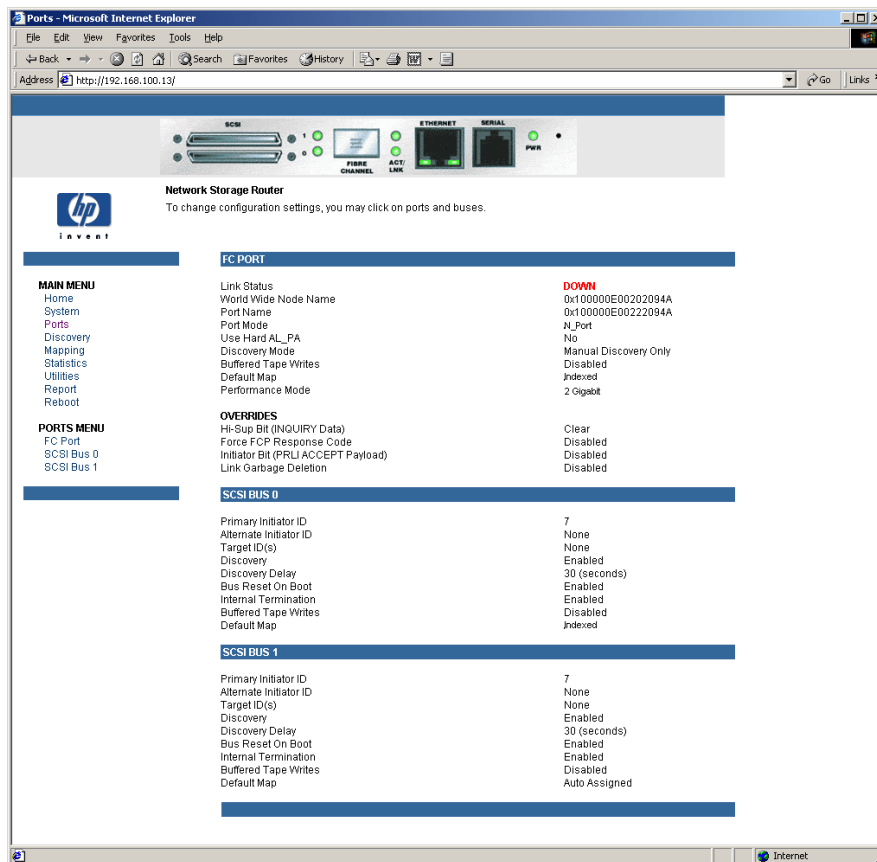

Figure 19: Ports menu

The initial screen display of the Ports Menu includes summary information about each Fibre Channel port and SCSI bus in the router.

Note: To view or change configuration settings of a specific port or bus, select it from the menu bar on the left side of the screen or select the port or bus from the router image at the top of the screen.

To make changes, modify the setting and then click **Submit**.

Ports Menu tasks:

- **Fibre Channel Port configuration** changes Fibre Channel port settings.
- **SCSI Bus configuration** changes SCSI bus settings.

Each Ports Menu option is discussed in the following subsections.

Fibre Channel Port Configuration

When the Fibre Channel port is selected in Ports Menu, the Fibre Channel Configuration screen is displayed. Figure 20 is an example of the Fibre Channel Configuration screen.

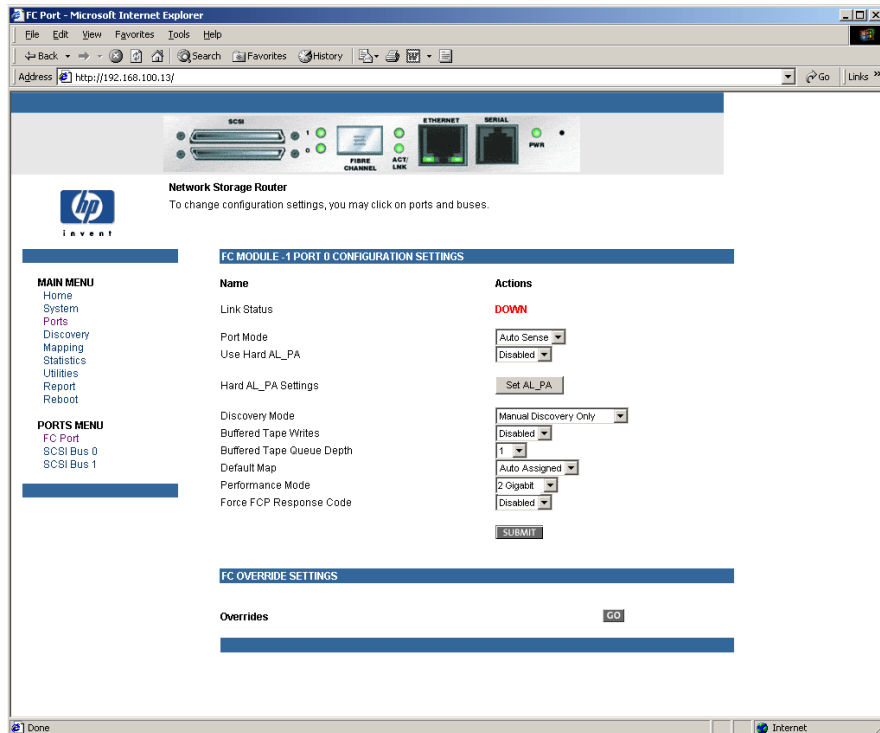

Figure 20: Fibre Channel Configuration screen

Fibre Channel port settings:

- **Link Status** indicates the port link status.
- **Port Name High** sets a new value for the World Wide Port Name High. (Service Mode - Restricted Access)



Caution: If the following configuration settings are incorrectly set, processing difficulties may occur. Before changing these settings, evaluate the need for the change and verify the desired setting. HP recommends backing up the router configuration to an external file before making changes to these settings.

- **Port Name Low** sets a new value for the World Wide Port Name High. (Service Mode - Restricted Access)

- **Port Mode** (default: N_Port) sets the port mode.

Port Mode settings:

- **Auto Sense:** In this mode, the Fibre Channel port tries to negotiate as a loop. If it is not successful, then the Fibre Channel port negotiates as a fabric. If the port comes up as a loop, it then determines whether it is on a private or public loop.
- **N_Port:** (default) This mode allows the router to bypass the loop negotiation and come up as a fabric only. If the router is on a loop, and N_Port mode is selected, an error in communication may occur.

- **Use Hard AL_PA** enables or disables Hard AL_PA usage.
- **Hard AL_PA Settings** displays the AL_PA Lookup Table.

Use the table to find the node number. This unique one-byte valid value (derived from an Arbitrated Loop Topology defined in ANSI specification FC_AL version 4.5) is used for the Fibre Channel configuration.

- **Discovery Mode** (default: Manual Discovery Only) determines how the router will discover new Fibre Channel devices.

Discovery mode settings:

- **Auto Discovery on Reboot Events** allows the router to automatically discover all Fibre Channel devices when rebooted or when link-up events occur, such as connecting cables or rebooting network hubs.
- Both the ports and the devices behind the ports are discovered on all subsequent link-up events.
- **Auto Discovery on Link Up Events** allows the router to automatically discover all Fibre Channel devices when rebooted or when link-up events occur, such as connecting cables or rebooting network hubs.
- Both the ports and the devices behind the ports are discovered for the first link-up event. Subsequent link-up events will only discover the ports and not the devices behind the ports.

- **Manual Discovery Only** (default) sets discovery of new devices to occur only after the user selects the **Discovery** option from the Main Menu or when a Registered State Change Notification (RSCN) is received from a fabric.

Note: SCSI devices attached to a Fibre Channel must be mapped as sequential Fibre Channel LUNs starting at LUN number 00. Skipping LUN numbers is not recommended when mapping Fibre Channel LUNs because Fibre Channel Discovery stops the discovery process whenever an empty LUN position is found.

- **Buffered Tape Writes** (default: enabled) enables or disables the Buffered Tape Write option.



Caution: If this configuration setting is incorrectly set, processing difficulties may occur. Before changing this setting, evaluate the need for the change and verify the desired setting. HP recommends backing up the router configuration to an external file before making changes to this setting.

When enabled, to enhance performance, Buffered Tape Writes return status on consecutive write commands prior to the tape device receiving data.

- **Buffered Tape Queue Depth** sets the Buffered Tape Queue Depth. Select a setting of 0 through 10 from the drop-down list.
- **Default Map** (default: indexed) sets the current mapping mode for the selected port.

The current map can be set to:

- Port 0 Device Map (HP recommends that this map be used to edit and assign oncoming hosts.)
- Indexed (default) (HP recommends that this map NOT be edited, even though the user is able to edit the Indexed map.)
- Auto-assigned contains all the SCSI devices that are attached to the router.
- SCC

For more information about mapping modes, see Appendix C, "[Addressing Methods and Table Structures](#)."

For information on changing map settings, see "[Mapping Menu](#), page 65," later in this chapter.

- **Performance Mode** (default: 2 Gb/s) toggles between 1 Gb/s and 2 Gb/s.

Note: If Performance Mode is set incorrectly and the router is plugged into a Loop or Fabric, the unit may receive Framing errors due to the incorrect Fibre Channel link speed.

- **Override Settings** (service mode-restricted access) enhances interoperability with some storage devices that require special consideration during setup of the router configuration menus.
 - **Hi-Sup Bit** toggles between **Set** and **Clear**.
 - **Force FCP Response Code** toggles between **Off** and **On** for support of HP-specific HBA #223180-B21 and #120186-001.
 - **Initiator Bit** toggles between **Set** and **Clear**.

When using the router in a router-to-router configuration, this option should be configured to **Set**. A router-to-router configuration is a type of configuration where one router appears as a target to another initiator router.
 - **Link Garbage Deletion** toggles between **Enabled** and **Disabled**.

SCSI Bus Configuration

When a SCSI bus is selected in the Ports Menu, the SCSI Bus Configuration screen is displayed. [Figure 21](#) is an illustration of the SCSI Bus Configuration screen.

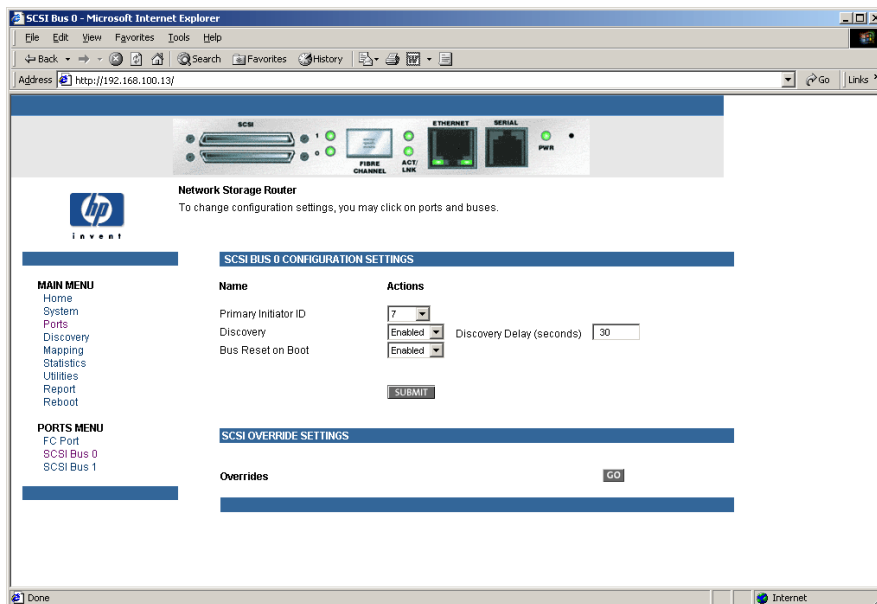

Figure 21: SCSI Bus Configuration screen

SCSI bus configuration settings:

- **Primary Initiator ID** (default: 7) must be a unique ID.
- **Alternate Initiator ID** (service mode-restricted access) (default: none) will be used if the primary ID is taken. Must be a unique ID.
- **Target ID(s)** adds or removes Target IDs.



Caution: If this configuration setting is incorrectly set, processing difficulties may occur. Before changing this setting, evaluate the need for the change and verify the desired setting. HP recommends backing up the router configuration to an external file before making changes to this setting.

Note: Target IDs must be setup before mapping devices on the SCSI bus.

Note: Do not enable Target IDs unless there is a SCSI initiator on the bus that wants to use Fibre Channel devices. This type of configuration is known as a Target Mode configuration.

- **Discovery** toggles between **Enabled** and **Disabled**.
 - **Discovery Delay** is the wait time after a power-up or reboot before discovering SCSI devices.
-

Note: HP recommends setting the value to at least 30 seconds to ensure all SCSI devices complete their individual power-ups.

- **Bus Reset on Boot** toggles between **Enabled** and **Disabled**.

When enabled, the router will automatically reset SCSI buses during a power up or reboot of the router.

- **Internal Termination** toggles between **Enabled** and **Disabled**.
-



Caution: If this configuration setting is incorrectly set, processing difficulties may occur. Before changing this setting, evaluate the need for the change and verify the desired setting. HP recommends backing up the router configuration to an external file before making changes to this setting.

When enabled, internal termination of the selected SCSI bus is allowed. When disabled, the SCSI Bus, not the router handles SCSI termination.

- **Buffered Tape Writes** (default: Enabled) toggles between **Enabled** and **Disabled**.

When enabled, Buffered Tape Writes enhance system performance. Buffered Tape Writes return status on consecutive write commands prior to the tape device receiving data.

- **Default Map** (default: auto-assigned) sets the current mapping mode for the selected bus.



Caution: If this configuration setting is incorrectly set, processing difficulties may occur. Before changing this setting, evaluate the need for the change and verify the desired setting. HP recommends backing up the router configuration to an external file before making changes to this setting.

The current map can be set to:

- Auto-assigned (default) contains all the devices attached to the router.
- Indexed
- SCC
- Custom

For more information about mapping modes, see Appendix C, "[Addressing Methods and Table Structures](#)."

For information on changing map entries, see "[Mapping Menu](#), page 65," later in this chapter.

- **Override Settings** (Service mode-restricted access) To override the settings of a SCSI target, select a Target ID icon with the appropriate Target ID number.

After a specific Target is selected, the SCSI Override sub-screen is displayed and is used to enter the Override settings.

SCSI bus override settings:

- **CDB Length Override** enables or disables the override of default CDB lengths.
- **CDB Group 6 Length Default** (default: 0) can be set to 0, 6, 10, or 12.
- **CDB Group 7 Length Default** (default: 0) can be set to 0, 6, 10, or 12.
- **Wide Negotiation** enables or disables negotiation on a wide SCSI bus.
- **Synchronous Negotiation** enables or disables synchronous negotiation on the SCSI bus.

- **Synchronous Parameter Override** enables or disables parameters for synchronous negotiation.
- **Synchronous Period** (default: 40) sets the maximum number of seconds allowed for negotiation.
- **Synchronous Offset** (default: 16) sets the maximum variation in transfer rate that can be negotiated in megabytes per seconds (MB/s).
- **Ultra SCSI-3 Negotiation** enables or disables Ultra SCSI-3 support for the selected Target ID.

When enabled, Ultra SCSI-3 Negotiation helps solve certain compatibility issues in mixed vendor environments where there may be a device that cannot handle automatic negotiation of the bus speed or where there is a device that negotiates to use Ultra SCSI-3 but cannot handle the speed.

Discovery Menu

Accessed from the Main Menu, the Discovery Menu is used to view Target devices and discover new Target devices.

Figure 22 is an example of the Discovery page.

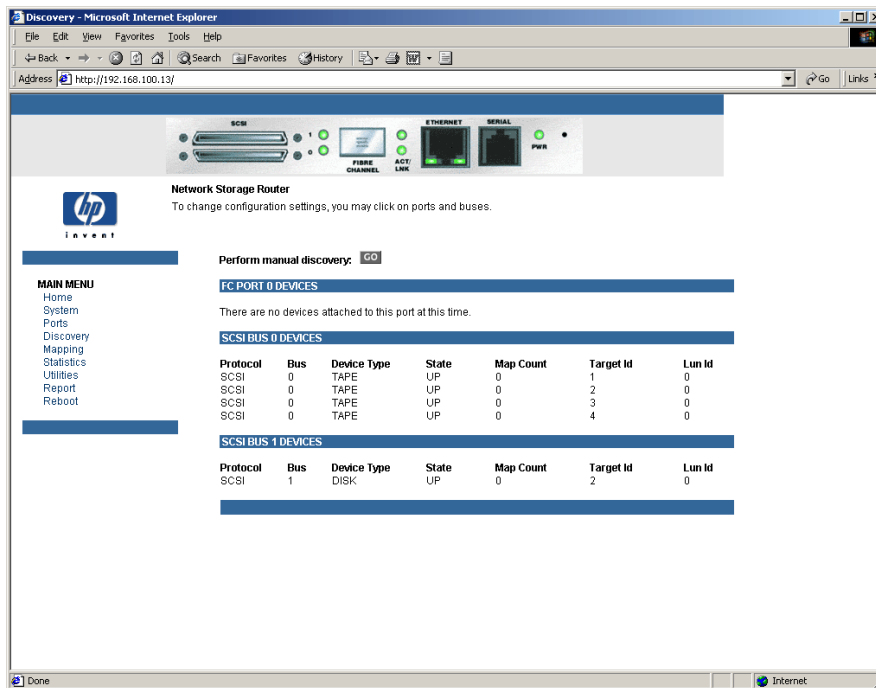

Figure 22: Discovery page

To perform a manual discovery:

1. Select the Fibre Channel port or SCSI bus from the menu bar or the router image.
2. Select **Go**.

Mapping Menu

Each physical port/bus on the router can have the following maps:

Table 5: Device Map Types

Map Type	System/User Generated	Fibre Channel or SCSI
Auto Assigned	System	Fibre Channel and SCSI
Indexed (default)	System	Fibre Channel and SCSI
Port <0> Device	System	Fibre Channel
SCC	System	Fibre Channel

Note: Port 0 Device Map is the HP recommended map to be used for editing and assigning oncoming hosts. The Indexed (default) map should not be used for editing, even though the user is able to edit this map.

Each map has a unique name and map ID; one of the maps must be identified as the “current” map for the router to use.

Accessed from the Main Menu, the Mapping Menu is used to view and modify host and map information for a Fibre Channel port or SCSI bus. Maps and hosts can be added, edited, or deleted.

To view or change map settings of a specific port or bus:

1. Select the port or bus from the menu bar on the left side of the screen or from the router image at the top of the screen.
Specific mapping information is displayed, including the name of the port, the selected host, and the assigned map.
2. To make changes to the configuration, enter the new value and then select **Submit**.

Because some mapping configuration settings are the same for Fibre Channel and SCSI maps and some settings are unique, this mapping section is subdivided as follows:

- [Common Fibre Channel and SCSI Mapping Tasks](#), page 66
- [Fibre Channel Mapping Tasks](#), page 67
- [SCSI Mapping Tasks](#), page 71

Common Fibre Channel and SCSI Mapping Tasks

Although the initial screen display for Fibre Channel and SCSI maps differs slightly, the available actions are the same.

Figure 23 is an illustration of the Fibre Channel mapping screen.

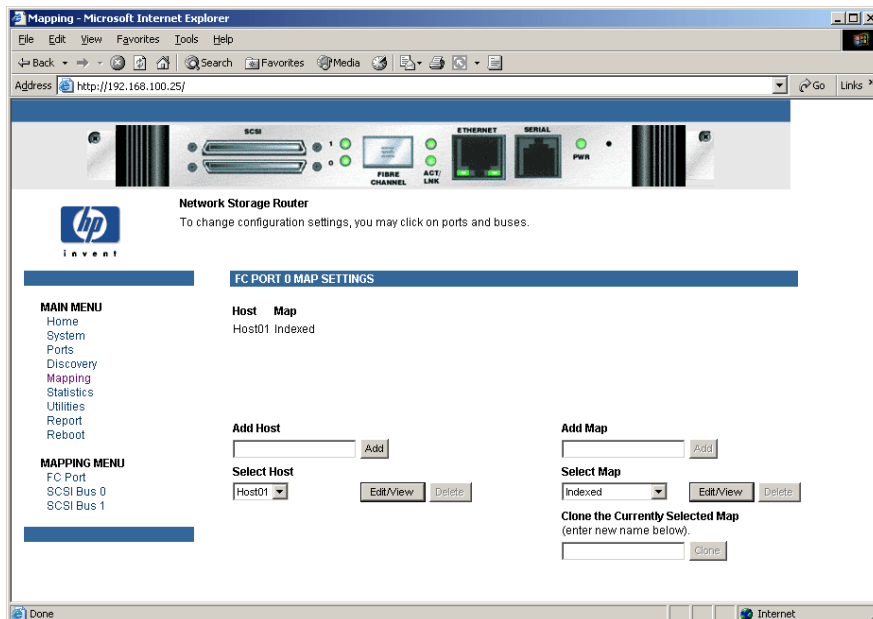

Figure 23: Initial Mapping screen

Mapping screen options:

- **Select Host** adds a known host.
To select a previously set up host, expand the **Select Host** drop-down box and select the host from the list.
- **Edit/View Host** displays or changes host information.
Viewing and changing host information is discussed in the following paragraphs.
- **Delete Host** deletes the current host.

Note: Host lists built during POST cannot be deleted.

- **Add Map** adds a new map.
To add an undefined map, type the name of the map in the **Add Map** field and then click **Add**.
- **Select Map** adds a known map.
To select a previously set up map, expand the **Select Map** drop-down box and select the map from this list.
- **Edit/View Map** displays or changes map information.
Viewing and changing map information is discussed in the following paragraphs.
- **Delete Map** deletes the current map.

Note: 'Indexed,' 'Auto Assigned,' and 'SCC' maps cannot be deleted or renamed.

Fibre Channel Mapping Tasks

Configuration tasks for Fibre Channel mapping includes:

- [Viewing and Changing Fibre Channel Host Information](#), page 68
- [Viewing and Changing Fibre Channel Map Information](#), page 69

Each task is discussed in the following paragraphs.

Note: Port 0 Device Map is the HP recommended map to be used for editing and assigning oncoming hosts. The Indexed (default) map should not be used for editing, even though the user is able to edit this map.

Viewing and Changing Fibre Channel Host Information

To view or change current host information:

1. In the Mapping Menu screen, select the desired Fibre Channel port.
2. Click **Edit/View** in the Host section of the screen.

The Fibre Channel Host Name dialog box is displayed. Current host information is shown at the top of the dialog box.

3. Enter the new settings and then select **Modify**.

Fibre Channel Host Name settings:

- **Host Name**
- **Host ID** (hexadecimal)
- **Port WWN Hi** (hexadecimal) (service mode-restricted access)
- **Port WWN Lo** (hexadecimal) (service mode-restricted access)
- **Node WWN Hi** (hexadecimal) (service mode-restricted access)
- **Node WWN Lo** (hexadecimal) (service mode-restricted access)
- **Map Name**

Viewing and Changing Fibre Channel Map Information

Note: Port 0 Device Map is the HP recommended map to be used for editing and assigning oncoming hosts. The Indexed (default) map should not be used for editing, even though the user is able to edit this map.

To view or change current Fibre Channel map information:

1. In the Mapping Menu screen, select the Fibre Channel port.
2. Select **Edit/View** in the Map section of the screen.
The Fibre Channel Map dialog box is displayed. Current map information is shown at the top of the dialog box.
3. Enter the new settings and then select the appropriate action button.

Note: Auto-Assigned and SCC maps cannot be modified, cleared, filled, or have entries removed.

Note: Map settings are saved to memory when any button within the page is selected.

Fibre Channel map settings:

- **Clear Map** clears all entries from the current map.
- **Remove Gaps** removes any incremental gaps in the sequence of LUNs listed in the table.

When the system removes gaps from the table, the LUNs are renumbered in sequential order, starting with LUN 0.

Note: Some operating systems require gaps be removed in the mapping table in order to detect all devices.

- **Fill Map** fills in the current map.
To use the Fill Map option, expand the Fill Map Priority drop-down box, select the fill option, and then click **Fill Map**.
When the map is filled, the display shows the current devices.
- **Delete** deletes map entries.

To delete map entries, expand the Delete Map Item LUN drop-down box, select the LUN, and then click **Delete**.

To delete a range of LUNs, select the beginning LUN to delete from the “from” drop-down box and select the last LUN to delete from the “to” drop-down box.

- **Discovered Device Entry** adds a discovered device to the map.

To add a discovered device to the map, use the drop-down boxes to enter the settings, and then click **Create Entry** in the Discovered Device Entry section of the screen.

- **Manual Device Entry** creates a map entry for a device that is not yet discovered or installed.

To add a new device to the map, use the drop-down boxes to enter the settings, and then click **Create Entry** in the Manual Device Entry section of the screen.

SCSI Mapping Tasks

Configuration tasks for SCSI mapping include:

- Viewing and Changing SCSI Host Information
- Viewing and Changing SCSI Map Information

Each task is discussed in the following paragraphs.

Viewing and Changing SCSI Host Information

To view or change current SCSI host information:

1. In the Mapping Menu screen, select the desired SCSI bus.
2. Click **Edit/View** in the Host section of the screen.

The SCSI Host Name dialog box is displayed. Current host information is shown at the top of the dialog box.

3. Enter the new settings and then click **Modify**.

Figure 24 is an example of the SCSI Host Name configuration dialog box.

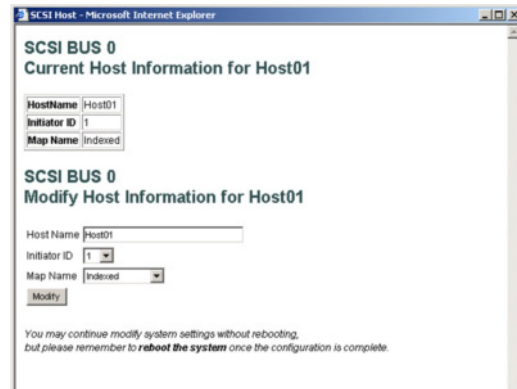

Figure 24: SCSI Host Name dialog box

SCSI Host Name settings:

- Host Name
- Initiator ID
- Map Name

Viewing and Changing SCSI Map Information

To view or change current SCSI map information:

1. In the Mapping Menu screen, select the desired SCSI bus.
2. Select **Edit/View** in the Map section of the screen.

The SCSI Map dialog box is displayed. Current map information is shown at the top of the dialog box.

3. Enter the new settings and then click the appropriate action button.

Figure 25 is an example of the SCSI Map dialog box.

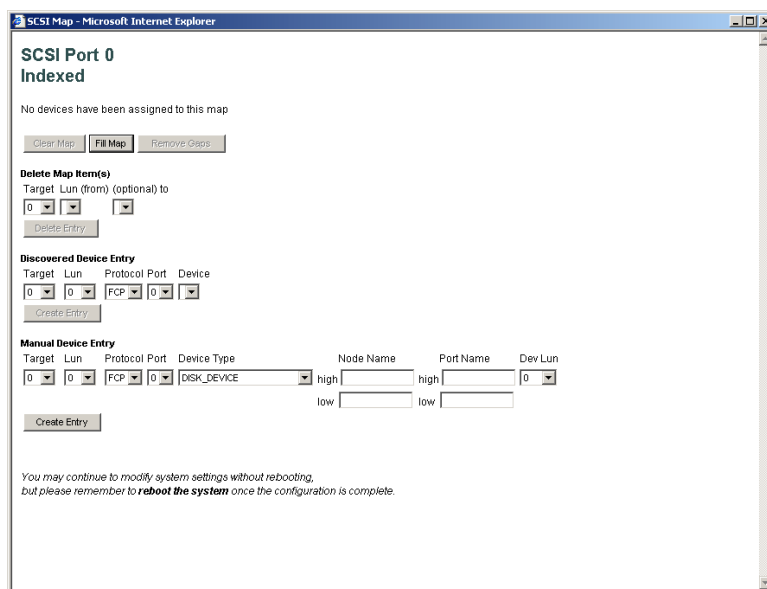

SCSI Map - Microsoft Internet Explorer

SCSI Port 0 Indexed

No devices have been assigned to this map

Clear Map Fill Map Remove Gases

Delete Map Item(s)
Target Lun (from) (optional) to
0 0
Delete Entry

Discovered Device Entry
Target Lun Protocol Port Device
0 0 FCP 0
Create Entry

Manual Device Entry

Target	Lun	Protocol	Port	Device Type	Node Name	Port Name	Dev Lun
0	0	FCP	0	DISK_DEVICE	high	high	0
					low	low	

Create Entry

You may continue to modify system settings without rebooting,
but please remember to **reboot the system** once the configuration is complete.

Figure 25: SCSI Map Dialog box

Note: To map Fibre Channel devices to any SCSI initiator on the selected bus, a Target ID must be enabled from the SCSI Bus Configuration Menu. A Target ID should only be added if there is a SCSI initiator that needs to address Fibre Channel devices. Each Target ID can be used to store up to 32 Fibre Channel devices.

Note: Auto-Assigned and SCC maps cannot be modified, cleared, filled, or have entries deleted.

Note: Map settings are saved to memory when any button within the page is selected.

Note: SCSI maps can be filled or devices can be added to them only when at least one SCSI Target ID has been enabled in the SCSI Bus Configuration Menu.

SCSI Map settings:

- **Clear Map** clears all entries from the current map.
- **Fill Map** fills in the current map.
When the map is filled, the display shows the current devices.
- **Remove Gaps** removes any incremental gaps in the sequence of LUNs listed in the table.
When the system removes gaps from the table, the LUNs are renumbered in sequential order, starting with LUN 0.

Note: Some operating systems require gaps be removed in the mapping table to detect all devices.

- **Delete** deletes map entries.
To delete a range of LUNs, select the beginning LUN to delete from the 'from' drop-down box and select the last LUN to delete from the 'to' drop-down box.
- **Discovered Device Entry** adds a discovered device to the map.
To add a discovered device to the map, use the drop-down boxes to enter the settings, and then click **Create Entry** in the Discovered Device Entry section of the screen.
- **Manual Device Entry** creates a map entry for a device that is not yet discovered or installed. To add a new device to the map, use the drop-down boxes to enter the settings, and then click **Create Entry** in the Manual Device Entry section of the screen.

Statistics Menu

Accessed from the Main Menu, the Statistics Menu is used to display Fibre Channel port and SCSI bus information. [Figure 26](#) is an example of the Statistics Menu.

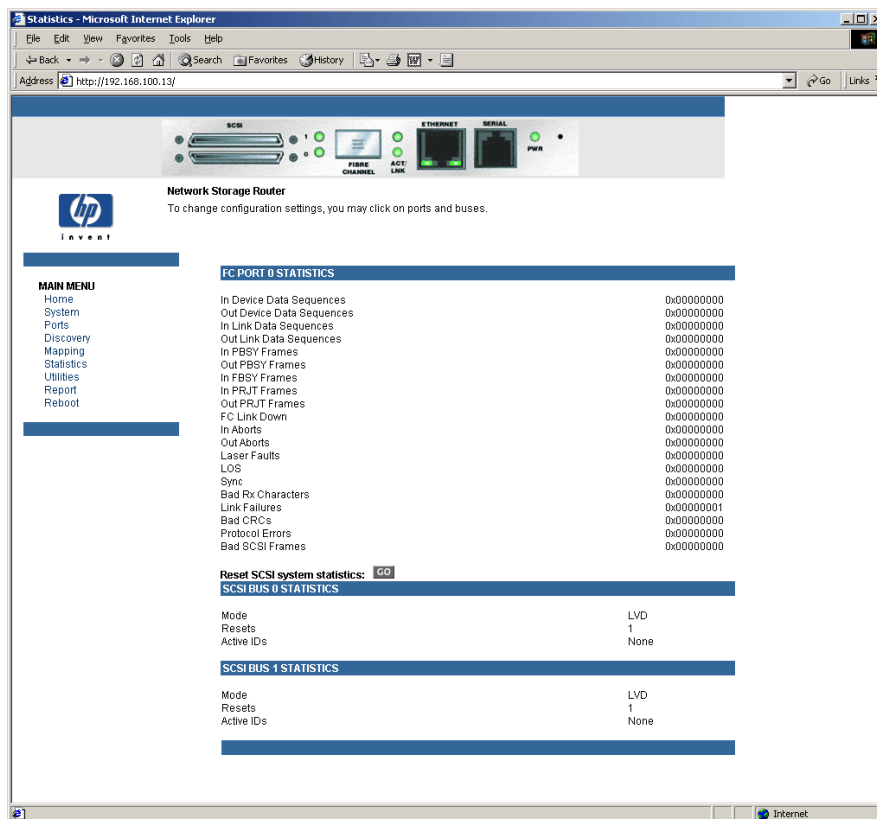

Figure 26: Statistics menu

To view information for a specific port or bus, click the component on the menu bar or the router image. To refresh the display, select **Reset SCSI system statistics**.

Utilities Menu

Accessed from the Main Menu, the Utilities Menu is used to view and configure utility options.

Figure 27 is an example of the Utilities Menu.

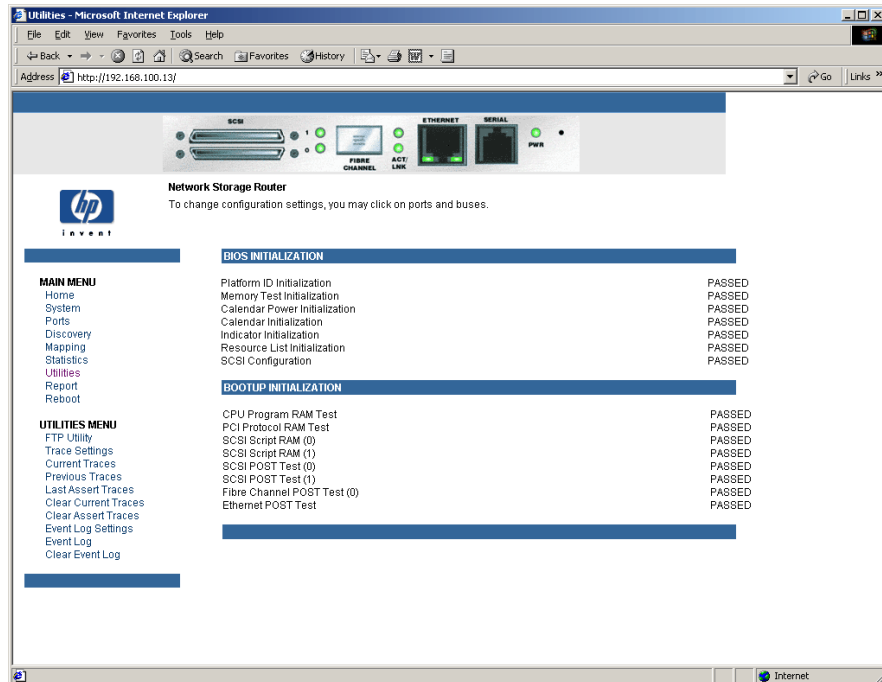

Figure 27: Utilities menu

Utility Menu tasks:

- **FTP Utility access** opens an FTP session.
- **Trace Settings configuration** configures trace settings.
- **Current Traces display** displays current trace information.
- **Previous Traces display** displays previous trace information.
- **Last Assert Traces display** displays last assert trace information.
- **Clear Current Traces** clears current trace information.
- **Clear Assert Traces** clear current trace information.

- **Event Log Settings** configures Event Log settings.
- **Event Log display** displays the Event Log.
- **Clear Event Log** clears the Event Log.

Each Utility Menu option is discussed in the following sections.

FTP Utility Access

The FTP utility screen is used to open an FTP session.

Figure 28 is an example of the FTP utility screen.

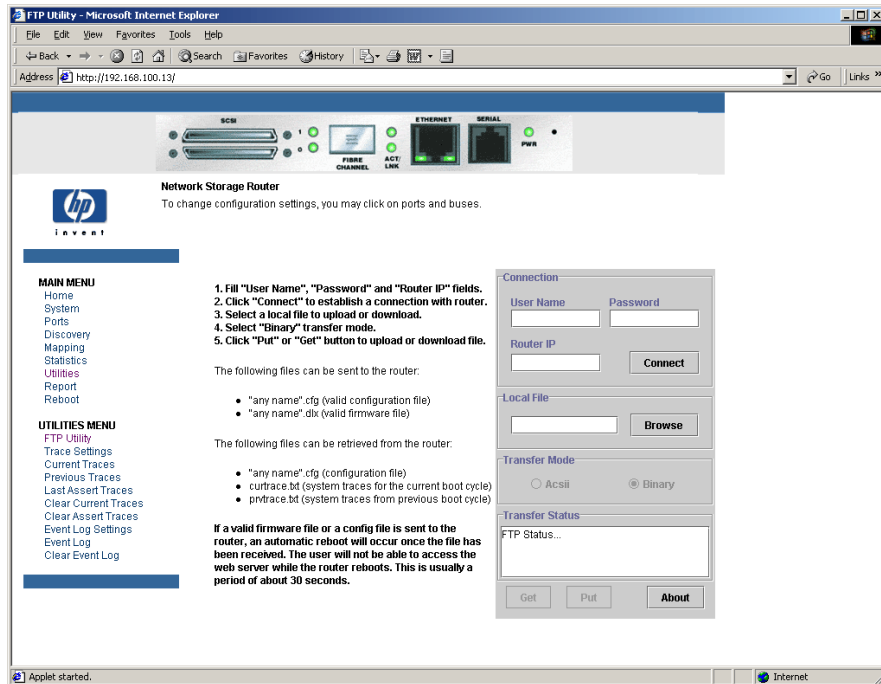

Figure 28: FTP Utility screen

The FTP utility requires the use of a JAVA applet and prompts for permission to install the applet, if needed. If the prompt is displayed, follow the onscreen instructions to complete the installation. The FTP utility then prompts for permission to run the applet.

Note: Internet access is required to verify the signature for the HP FTP applet and to download the JAVA applet plug-in for your browser.

To open an FTP session:

1. Enter the User Name, Password, and the IP address of the router.
2. Click **Connect**.
3. Select the local file to upload or download. If necessary, click **Browse** to scroll through a file list.

The following file types can be uploaded to the router:

- Configuration (*.cfg*)
- Firmware (*.dlx*)

The following file types can be downloaded from the router:

- Configuration (*.cfg*)
- Traces for the current boot cycle (*curtrace.txt*)
- Traces from the previous boot cycle (*prvtrace.txt*)

4. Click **Binary** Transfer mode.
5. Choose the desired task:
 - To download a file, click **Get**.
 - To upload a file, click **Put**.

Note: If a valid firmware or configuration file is uploaded to the router, an automatic reboot will occur once the file has been received. The router cannot be accessed from the Visual Manager UI during the time that the reboot is in process, which is approximately 30 seconds.

Trace Settings Configuration

The Trace Settings screen is used to configure the trace settings.

Figure 29 is an example of the Trace Settings screen.

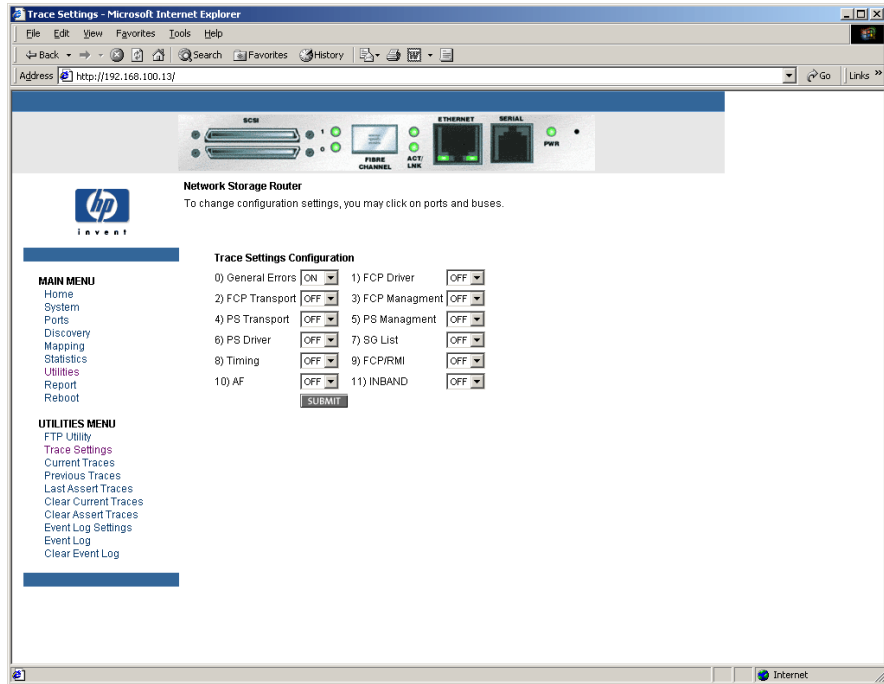

Figure 29: Trace Settings screen

Current Trace settings are displayed.

To change the settings, use the drop-down boxes and choose the desired setting. After all changes are completed, select **Submit**.

Table 6 is a brief description list of the trace settings.

Table 6: Trace Settings

Setting	Description
General Errors	Displays the most serious errors and exception conditions.
FCP Transport	Fibre Channel Protocol transport functionality will be monitored and recorded.
PS Transport	Parallel SCSI transport functionality will be monitored and recorded.
PS Driver	Parallel SCSI driver functionality will be monitored and recorded.
Timing	Timer functions will be monitored and recorded.
AF	Active Fabric firmware will be monitored and recorded.
FCP Driver	Fibre Channel Protocol driver functionality will be monitored and recorded.
FCP Management	Fibre Channel Protocol management functionality will be monitored and recorded.
PS Management	Parallel SCSI functionality will be monitored and recorded.
SG List	Scatter/gather list will be monitored and recorded
FCP/RMI	Fibre Channel Protocol routing layer will be monitored and recorded.
INBAND	Controller management functionality will be monitored and recorded.

Current, Previous, and Last Assert Trace Displays

These three Utilities Menu screens show trace information. The Current Traces screen shows data since the router was last booted. The Previous Traces screen shows data from the last boot cycle. The Last Assert Traces screen shows data since the last assertion.

Figure 30 is an example of the Current Traces screen.

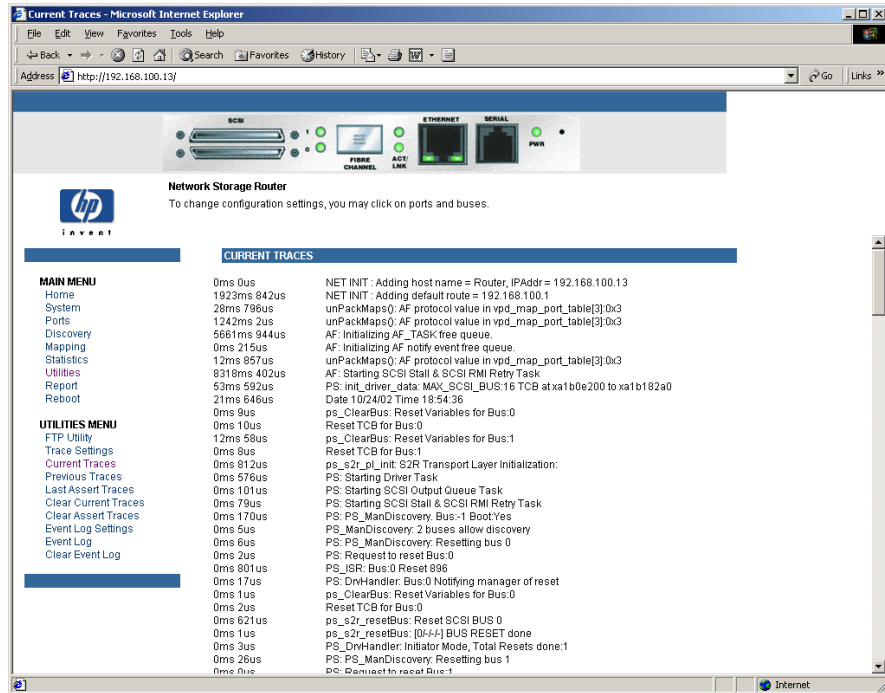

Figure 30: Current Traces screen

Clear Current Traces and Clear Assert Traces

These Utilities Menu screens are used to clear the current trace buffer or the assert trace buffer.

Current router activities will not be disrupted while the buffer is cleared.

Figure 31 is an example of the Clear Current Trace Buffer screen.

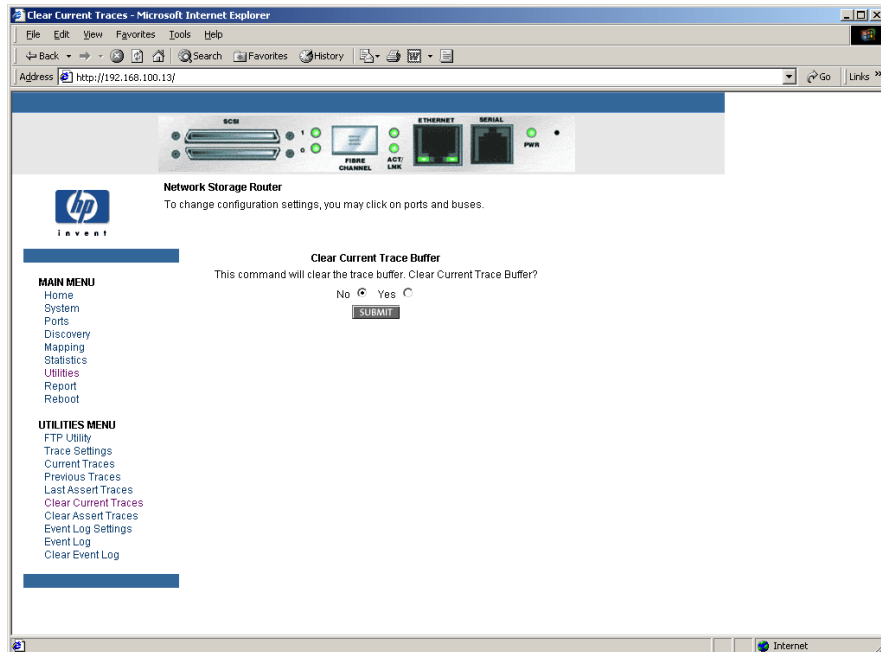

Figure 31: Clear Current Trace Buffer screen

Event Log Configuration

The Event Log Setting screen is used to configure Event Log filters. [Figure 32](#) is an example of the Event Log Filter configuration screen.

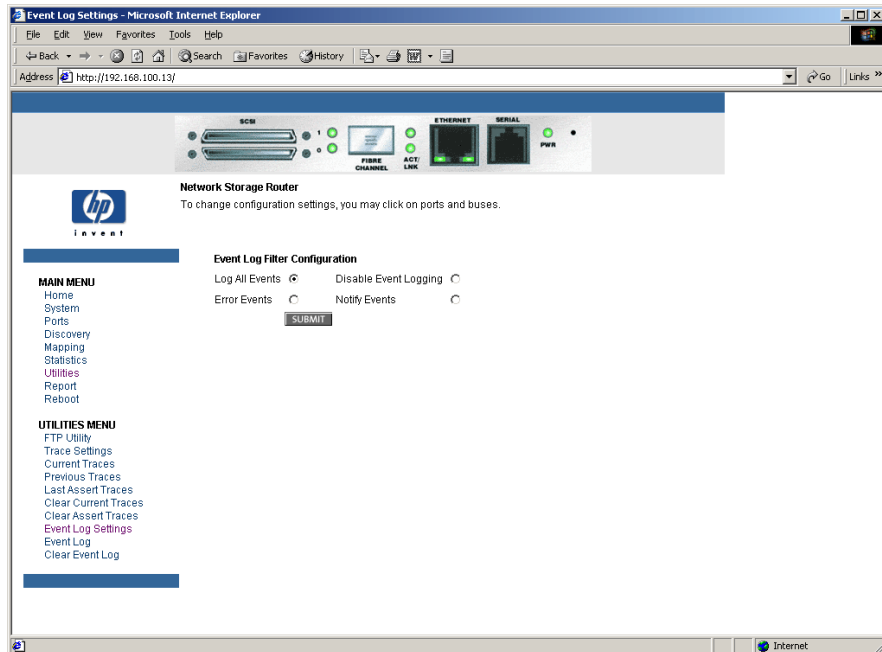

Figure 32: Event Log Settings screen

Event Log settings:

- Log All Events
- Disable/Enable Event Logging
- Log Error Events
- Log Notify Events

Event logging captures the last 215 events and then starts overwriting the log.

Note: To ensure accurate event logging, correctly set the clock and date in the Real Time Clock Configuration Menu.

Event Log Display

The Event Log screen is used to view the Event Log.

Figure 33 is an example of the Event Log display screen.

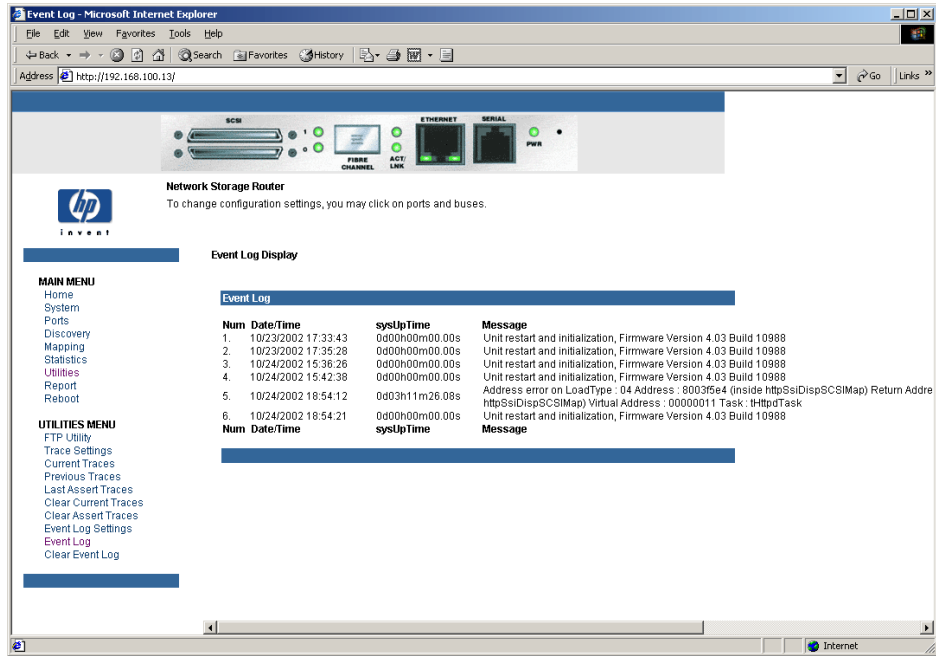

Figure 33: Event Log Display screen

Clear Event Log

The Clear Event Log screen is used to clear the Event Log.

Figure 34 is an example of the Clear Event Log screen.

Current router activities will not be disrupted.

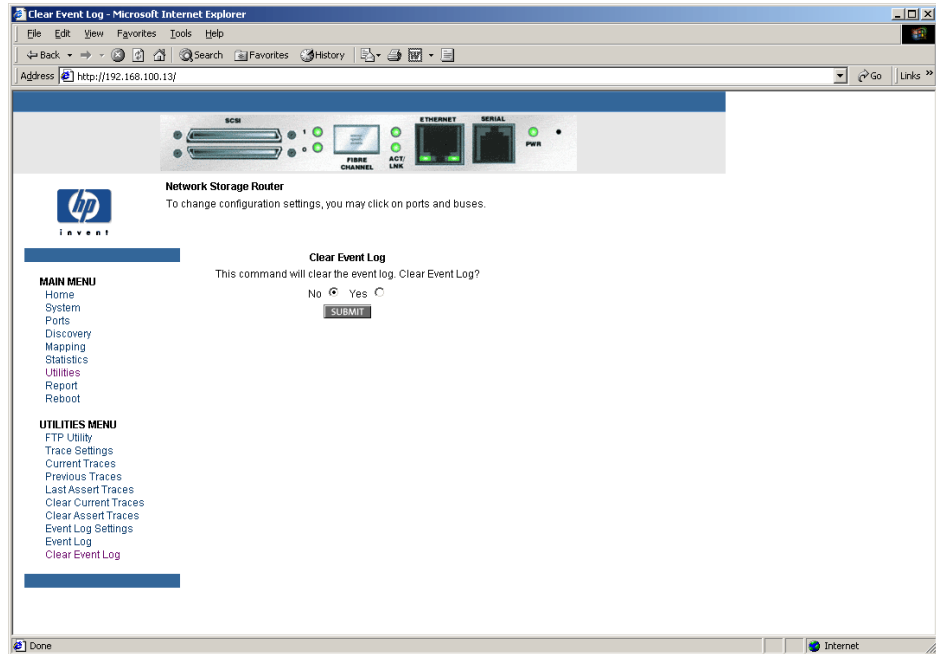

Figure 34: Clear Event Log screen

Report Menu

Accessed from the Main Menu, the Report screen displays a consolidated view of all system information, including environmental conditions. Figure 35 is an example of the Report screen.

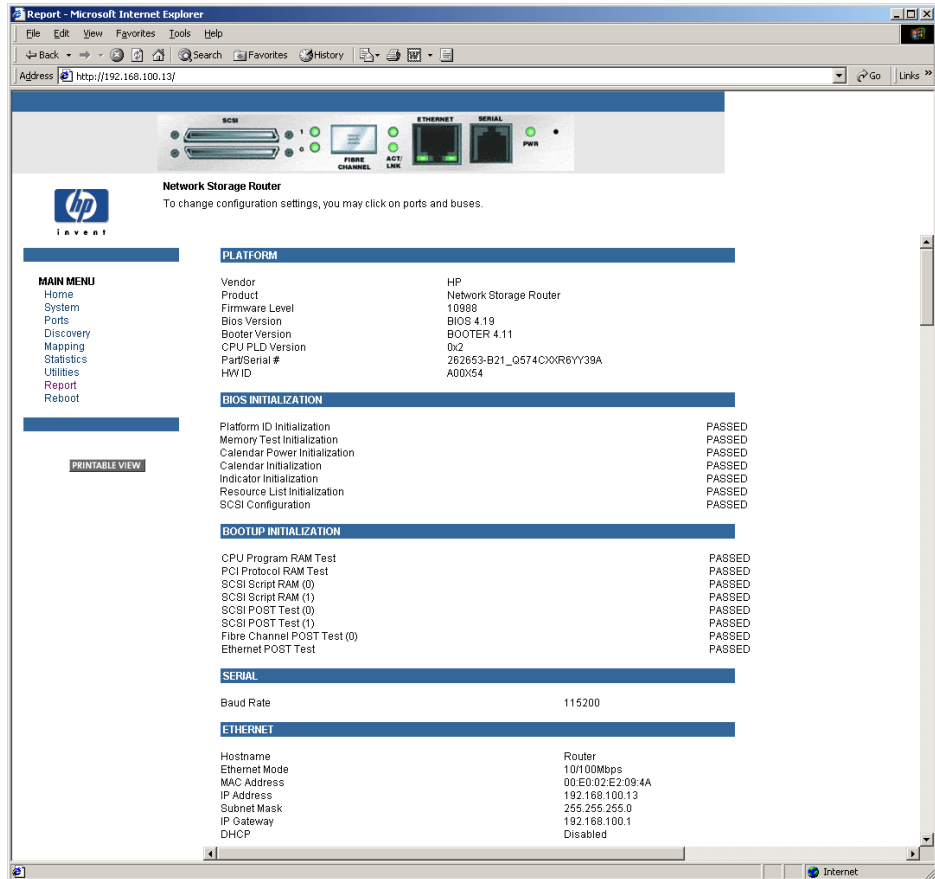

Figure 35: Report screen

Reboot Option

Router reboots are executed using this router Main Menu option. [Figure 36](#) is an example of the Reboot screen.

When the router is rebooted, current router activities will be disrupted. All submitted configuration changes will be activated during the boot-up process.



Caution: Confirm there is no activity, such as a backup in progress, before initiating a reboot as router activities will be disrupted.

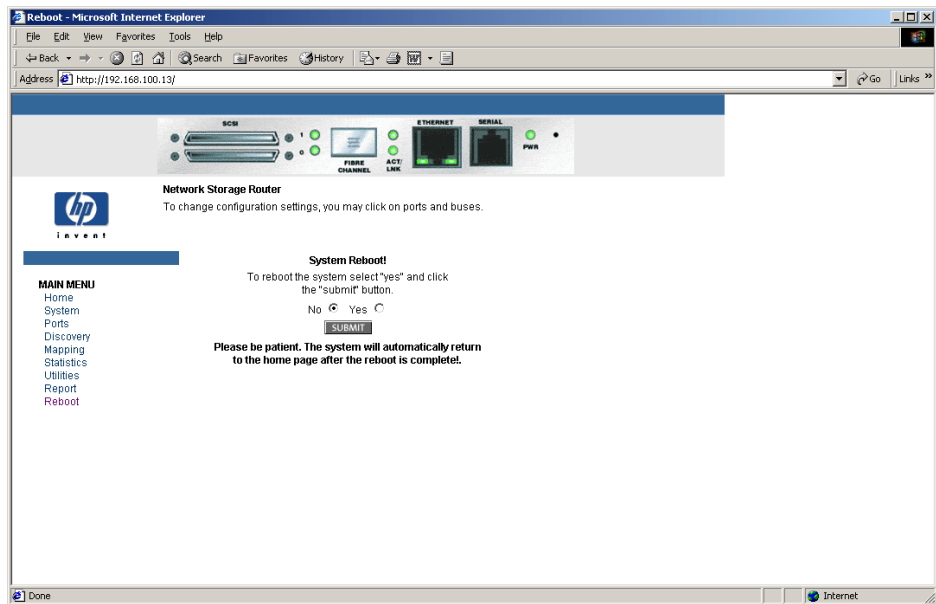

Figure 36: Reboot screen

Serial/Telnet User Interface

4

The Serial/Telnet User Interface (UI) is used to configure and manage the HP StorageWorks Network Storage Router. This chapter describes the configuration menus and option tasks available in the Serial/Telnet UI.

Note: Unless otherwise indicated, configuration changes take effect when the router reboots.

During the router start up process, the Serial/Telnet UI displays initial power-up messages. After the power-up process is completed, the Main Menu of the UI is displayed. Within the router Main Menu, several configuration menus and tasks are listed. All configuration and management tasks are performed from these menus.

This chapter is organized using the same structure as the router Main Menu and its associated sub-menus. The sections are:

- [Serial/Telnet Menu Tree](#), page 91
- [Telnet UI Access](#), page 92
- [Serial UI Access](#), page 92
- [Power up Messages](#), page 94
- [Serial/Telnet UI Main Menu](#), page 95

- [Configuration Menu](#), page 96
 - Baud Rate Configuration
 - Ethernet Configuration
 - Fibre Channel Configuration
 - Parallel SCSI Configuration
 - Device Mapping
 - Trace and Event Settings Configuration
 - Real-Time Clock Configuration
 - Active Fabric Configuration
 - Save Configuration
 - Restore Last Saved Configuration
 - Reset and Save Configuration to Factory Defaults
- [System Utilities Menu](#), page 130
 - System Statistics
 - Event Log
- [Trace Dump Menu](#), page 140
 - Saving Copies of the Trace Buffers using FTP
- [Reboot Option](#), page 142
- [Download New Firmware Option](#), page 142

Serial/Telnet Menu Tree

Main Menu

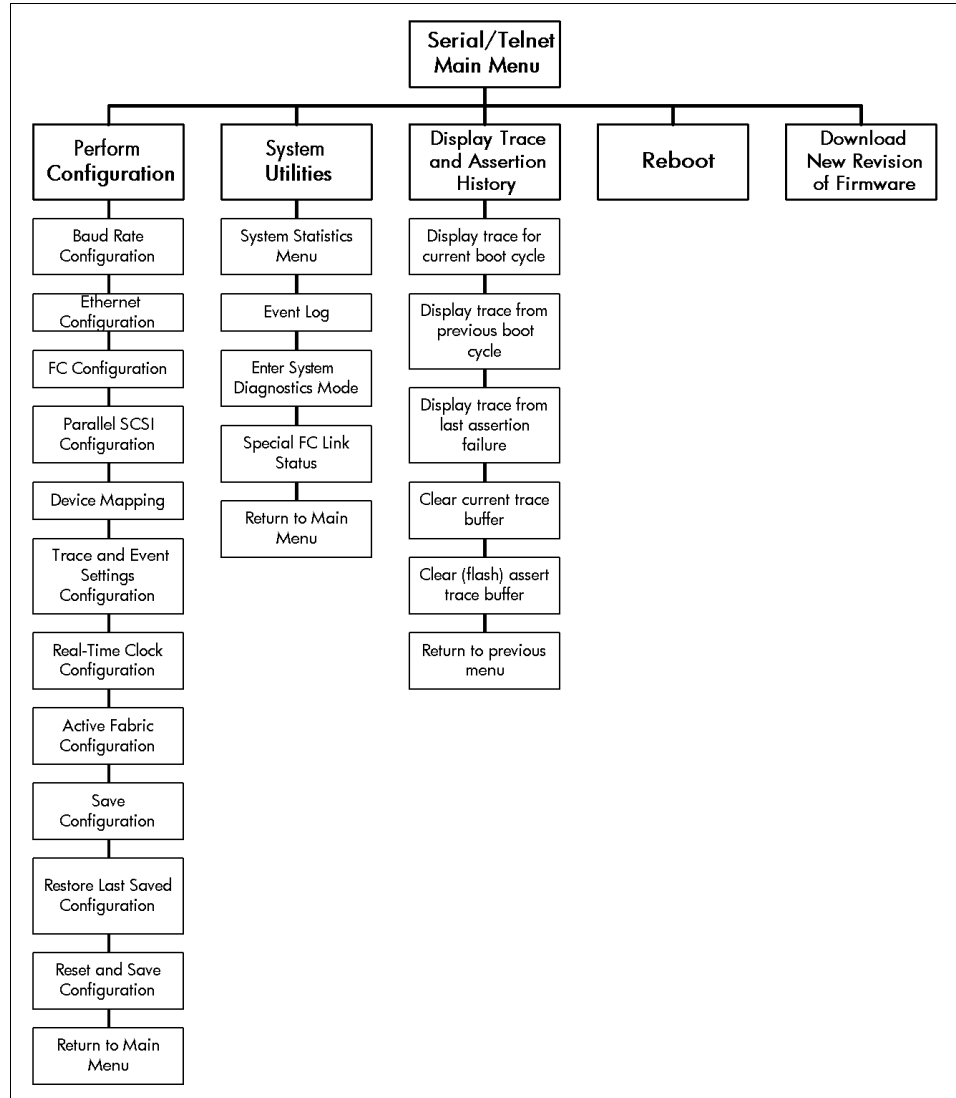

Telnet UI Access

To open a Telnet session, the IP address of the router and a Telnet client utility are required.

Note: After each reboot, a new Telnet session must be started. If the router is reset to factory settings, the Ethernet port will have to be re-configured using the serial interface.

From most Windows 9x, Windows NT, and Windows 2000 systems, a Telnet session can be started from the Command (DOS) shell using the following steps:

1. From the Windows **Start** Menu, open the Command Prompt (DOS) window.
2. At the '>' prompt, enter:

```
> TELNET <IP ADDRESS>
```

where <IP ADDRESS> is the IP address of the router

3. Enter the user name and password.

The default user name is `root` and the default password is `password`.

HP recommends that the user name and password be changed from the default values. The Configuration Menu is displayed.

Serial UI Access

To open a serial session, a terminal emulator utility is required.

From most Windows 9x, Windows NT, and Windows 2000 systems, a HyperTerminal session can be started using the following steps:

1. From the Windows **Start** Menu, open **HyperTerminal**.
2. Name the new terminal session.
3. Indicate the appropriate COM port.

4. Configure the serial port settings, as listed in [Table 7](#).

Table 7: Terminal Configuration Settings

BAUD Rate	Autobaud, 9600, 19200, 38400, 57600, 115200
Data Bits	8
Stop Bit	1
Parity	None
Flow Control	XON/XOFF

Note: HP recommends setting the baud rate to 115200.

5. After completing the serial port configuration, select **OK** to start a serial session.
6. After the serial session has started, press **Enter** several times to initiate router communication and display the Configuration Menu.

Power up Messages

When power is applied to the router, a series of messages is displayed on the serial terminal or terminal emulation program.

Figure 37 is an example of these power-up messages.

```
HP NSR           X.X\XXXXXX
CPU Program RAM: XXXXXXXX
PCI Protocol RAM: XXXXXXXX
SCSI Script RAM (I): XXXXXXXX
SCSI Script RAM (II): XXXXXXXX
Ethernet POST Test: PASSED
SCSI POST Test (I): PASSED
SCSI POST Test (II): PASSED
Fibre Channel POST: PASSED

Attaching network interface XXXXXX... done.
Attaching network interface XXX... done.
Initializing sioc...
Initializing SCSI port 0 (Differential)
SCRIPTS start @ 0x88002000 (4064)
Initializing SCSI port 1 (Differential)
SCRIPTS start @ 0x88006000 (4064)
Bridge:
Self test completed successfully
```

Figure 37: Power Up messages

Note: Throughout this chapter, XX represents value fields.

Serial/Telnet UI Main Menu

The Main Menu is the starting point for all configuration sub-menus and tasks. [Figure 38](#) is an illustration of the router Main Menu.

Note: If the power up messages and the Main Menu are not displayed, check the serial port settings.

```
HP Network Storage Router
X.XX.XX XXXXXX XXXXXX-XXX_XXXXXXXXXXXXXXXXX
01/06/2003 08:56:22

1) Perform Configuration
2) System Utilities
3) Display Trace and Assertion History
4) Reboot
5) Download a New Revision of The Firmware

Command >
```

Figure 38: Serial/Telnet main menu

Main Menu options:

- **1) Perform Configuration** enters router configuration settings.
- **2) System Utilities** displays system statistics and perform diagnostic tests.
- **3) Display Trace and Assertion History** displays trace information and clear the trace buffer.
- **4) Reboot** reboots the router.
- **5) Download a New Revision of the Firmware** replaces the current revision of the router firmware with a different copy of firmware.

Each Main Menu option is discussed in a separate section of this chapter.

Note: Except for the login process, uppercase and lowercase characters can be used interchangeably in all of the menus.

Configuration Menu

The Configuration Menu is used to configure the router.

[Figure 39](#) is an illustration of the Configuration Menu.

```
Configuration Menu
X.XX.XX XXXXXX XXXXXX-XXX_XXXXXXXXXXXXXXXXXX
01/06/2003 08:56:37

1) Baud Rate Configuration
2) Ethernet and SNMP Configuration
3) Fibre Channel Configuration
4) Parallel SCSI Configuration
5) Device Mapping
6) Trace and Event Settings Configuration
7) Real-Time Clock Configuration
8) Active Fabric Configuration

A) Save Configuration
B) Restore Last Saved Configuration
C) Reset and Save Configuration to Factory Defaults
X) Return to main menu
```

Figure 39: Configuration menu

Note: The router is shipped with a configuration of default settings that is acceptable for most system environments. Few changes to the configuration should be necessary. After any configuration changes are made, select A) Save Configuration to record the changes.

If the configuration has been modified to meet company-specific needs, back up the company-specific configuration to an external file. If necessary, these settings can later be restored to the router.

Configuration Menu options:

- **1) Baud Rate Configuration** changes the baud rate on the serial port.
- **2) Ethernet and SNMP (SNMP not supported) Configuration** enters Ethernet network settings.
- **3) Fibre Channel Configuration** configures the settings for the Fibre Channel port.
- **4) Parallel SCSI Configuration** configures the settings for the SCSI buses.

- **5) Device Mapping** modifies map and host settings.
- **6) Trace and Event Settings Configuration** modifies trace and event filter settings.
- **7) Real-Time Clock Configuration** sets the system clock.
- **8) Active Fabric Configuration** enables and disables server-free backup and changes the number of controller LUNs.
- **A) Save Configuration** saves changes to memory.
- **B) Restore Last Saved Configuration** reverts to the previous configuration.
- **C) Reset and Save Configuration to Factory Defaults** resets all configuration options to the factory defaults.
- **X) Return to Main Menu** goes back to the previous screen.

Because the Configuration Menu is the primary menu in the UI, each Configuration Menu option is discussed in a separate section.

Baud Rate Configuration

In the Configuration Menu, choose **1) Baud Rate configuration** to change the baud rate used on the serial port.

[Figure 40](#) is an illustration of the Baud Rate Configuration Menu.

```

      Baud Rate Configuration Menu
x.xx.xx xxxxxxxx xxxxxxxx-xxx_xxxxxxxxxxxxxxxxxx
      01/06/2003 08:56:47

1)  9600  2)  19200
3)  38400  4)  57600
5)  * 115200

X) Return to previous menu

```

Figure 40: Baud Rate Configuration menu

Options include:

- **1) 9600**
- **2) 19200**
- **3) 38400**
- **4) 57600**
- **5) 115200**

Note: The asterisk (*) symbol indicates the current setting for the baud rate.

Note: If the Autobaud feature is being used, it is not necessary to set a baud rate.

Ethernet Configuration

In the Configuration Menu, choose **2) Ethernet and SNMP (SNMP not supported) Configuration** to set up the Ethernet network. When this option is selected, the Ethernet Configuration Menu is displayed.

Current Ethernet settings are displayed, along with available Ethernet configuration options. [Figure 41](#) is an illustration of the Ethernet Configuration Menu.

```
      Ethernet Configuration Menu
      X.XX.XX XXXXXX XXXXXX-XXX_XXXXXXXXXXXXXXXXXX
                01/06/2003 08:56:55

IP Address           : 1.1.1.1
Subnet Mask          : 255.255.255.0
IP Gateway           : 0.0.0.0
Etherne Physical Address : 08:06:07:05:03:09
Ethernet Mode        : 10/100Mbps (Auto-Neg)
Hostname             : Router
DHCP Configuration   : Disabled

1) Change IP Address
2) Change IP Subnet Mask
3) Change IP Gateway
4) Change Ethernet Physical Address
5) Toggle Ethernet Mode
6) Change Hostname
7) Toggle DHCP Configuration
8) Change SNMP Settings
9) Change Security Settings
X) Return to previous menu
```

Figure 41: Ethernet Configuration menu

To view or change configuration settings:

1. Select a menu option
2. Make the configuration changes
3. Select **X) Return to previous menu**
4. Select **A) Save Configuration** to record the changes.

Ethernet Configuration Menu options:

- **1) Change IP address** (default: 1.1.1.1) changes the router IP address.
- **2) Change IP Subnet Mask** (default: 255.255.255.0) changes the router Subnet mask.
- **3) Change IP Gateway** (default: 0.0.0.0) changes the IP gateway for the Ethernet network.
- **4) Change Ethernet Physical Address** changes the Ethernet physical address (MAC address).



Caution: If this configuration setting is incorrectly set, processing difficulties may occur. Before changing this setting, evaluate the need for the change and verify the desired setting. HP recommends backing up the router configuration to an external file before making changes to this setting.

The manufacturer always assigns Ethernet physical addresses to the Ethernet adapters.

- **5) Toggle Ethernet Mode** changes the Ethernet mode.

Options include:

- 10 Mb/s only
 - 100 Mb/s (half duplex) only
 - 100 Mb/s (full duplex) only
 - 10/100 MPS (Auto-Neg.)
- **6) Change Hostname** changes the name of the host server.
The name can be any combination of alphanumeric characters, up to eight characters.

- **7) Toggle DHCP Configuration** enables or disables support for Dynamic Configuration Protocol.

When DHCP is enabled, the router will request a dynamic IP address from the DHCP server on the Ethernet network.

Some DHCP servers allow a lease reservation to be set up for an IP address by providing the server with the Ethernet MAC address. The DHCP server will then always provide the same IP address to the router. This setup can be useful for remote management of the router such as Telnet or Visual Manager. Because the method of setting up a lease reservation varies depending on the DHCP server being used, contact your Network Administrator for assistance.

Note: To use the DHCP feature, a DHCP server must be operational on the Ethernet network. If the DHCP feature is used when there is no DHCP server, DHCP standards require the router wait three minutes for a response from a DHCP server before timing out.

- **8) Change SNMP Settings** is not supported.
- **9) Change Security Settings** changes security settings, including the user name and password.

The default user name is `root` and the default password is `password`.



Caution: To ensure security, change the user name and password from the default settings.

Note: The security settings entered here affect all user interfaces.

User names and passwords should be unique and kept confidential. HP recommends using a combination of letters and numbers when creating user names and passwords.

Fibre Channel Configuration

In the Configuration Menu, choose **3) Fibre Channel Configuration** to configure the Fibre Channel port. The Fibre Channel Configuration Menu allows the configuration of ALPA settings, discovery mode, tape backup settings, port mode, default map, and override settings.

Figure 42 is an illustration of the Fibre Channel Configuration Menu.

```
Fibre Channel Configuration Menu
X.XX.XX XXXXXX XXXXXX-XXX_XXXXXXXXXXXXXXXXX
01/06/2003 08:57:15

Current Fibre Channel Configuration - Port 0
FC Link Status: UP
Node Name: Ox100000E0 020102AB
Port Name: Ox100000E0 022102AB
Use Hard ALPA: No
Discovery Mode: Manual Discovery Only
Buffered Tape Writes: Enabled, Queue Depth = 1
Port Mode: Auto Sense
Current Default Map 'Auto Assigned'
Port Speed: 1 GigaBit

1) Change World Wide Name High      2) Change World Wide Name Low
3) Toggle Hard ALPA Usage           4) Change ALPA Value
5) Toggle Discovery Mode             6) Toggle Buffered Tape Writes
7) Change Buffered Tape Queue Depth 8) Toggle Port Mode
9) Change Default Map Value         A) Edit FC Override Settings
X) Return to previous menu

Command >
```

Figure 42: Fibre Channel Configuration menu

Fibre Channel Configuration Menu options:



Caution: If these configuration settings are incorrectly set, processing difficulties may occur. Before changing these settings, evaluate the need for the change and verify the desired setting. HP recommends backing up the router configuration to an external file before making changes to these settings.

- **1) Change World Wide Name High** (service mode-restricted access) changes the World Wide Port Name High.
- **2) Change World Wide Name Low** (service mode-restricted access) changes the World Wide Port Name Low.
- **3) Toggle Hard AL_PA Usage** changes the Hard AL_PA usage to either **Yes** or **No**.
 - If set to **Yes**, a unique one-byte valid value (derived from an Arbitrated Loop Topology as defined in ANSI specification FC_AL version 4.5) is used for the Fibre Channel configuration.
 - When configuring the Fibre Channel AL_PA, the router presents a list of loop addresses along with the corresponding AL_PA. The user can select a loop address.
- **4) Change AL_PA Value** changes the AL_PA value. The AL_PA lookup table is displayed. Enter a node number from the table.
- **5) Toggle Discovery Mode** (default: Manual Discovery Only) determines how the router will discover new Fibre Channel devices.

Options include:

- **Auto Discovery on Reboot Events** allows the router to automatically discover all Fibre Channel devices during reboots, including both the ports and the devices.
- **Auto Discovery on Link-up Events** allows the router to automatically discover all Fibre Channel devices during reboots, including both the ports and the devices for the first link-up event. Subsequent link-up events will only discover the ports and not attached devices.

Note: SCSI devices attached to a Fibre Channel port must be mapped as sequential Fibre Channel LUNs starting at LUN number 00. Skipping LUN numbers is not recommended when mapping Fibre Channel LUNs because Fibre Channel Discovery stops the discovery process whenever an empty LUN position is found.



Caution: If these configuration settings are incorrectly set, processing difficulties may occur. Before changing these settings, evaluate the need for the change and verify the desired setting. HP recommends backing up the router configuration to an external file before making changes to these settings.

- **Manual Discovery Only** (default) sets discovery of new devices to only occur after the user selects the Refresh Device Display option. The Refresh Device Display option is accessed from the System Utilities Menu.
- **6) Toggle Buffered Tape Writes** (default: Enabled) changes the tape backup mode to either **Enabled** or **Disabled**.
- **7) Change Buffered Tape Queue Depth** changes the tape backup queue depth. Select a value from 0 through 10.
- **8) Toggle Port Mode** (default: N_Port) changes the port mode to either Auto Sense or N_Port:
 - **Auto Sense:** In this mode, the Fibre Channel port tries to negotiate as a loop. If it is not successful, then the Fibre Channel port negotiates as a fabric. If the port comes up as a loop, it then determines whether it is on a private or public loop.
 - **N_Port** (default): This mode allows the router to bypass the loop negotiation and come up as a fabric only. Use this setting if a HP switch is being used. If the router is on a loop and N_Port mode is selected, an error in communication may occur.
- **9) Change Default Map Value** (default: Indexed) changes and displays the default current map for the port.

Mapping modes can be Auto-Assigned, Indexed (default), or SCC.

For more information about addressing methods, see Appendix C, "[Addressing Methods and Table Structures](#)."
- **A) Edit FC Override Settings** (service mode-restricted access) enters Fibre Channel override settings.

A sub-screen is displayed, listing the following options:

- **1) Toggle Hi-Sup Bit Settings** changes the Hi-Sup Bit settings.
Options include **Set** and **Clear**.
- **2) Toggle Forcing FCP Response Code** for HP HBA #223180-B21 and #120186-001, changes the forcing of the FCP response code.
Options include **Off** and **On**.
- **3) Toggle Initiator Bit Setting in PRLI_ACC** changes the Initiator bit setting. Options include **Set** and **Clear**.
If the router is deployed in a router-to-router configuration where at least one router appears as target and another as initiator, set this option to **Set**.
- **4) Toggle FC Link Garbage Deletion** changes the Fibre Channel Link garbage deletion.
Options include **Enabled** and **Disabled**.

Parallel SCSI Configuration

In the Configuration Menu, choose **4) Parallel SCSI Configuration** to configure the SCSI buses. The Parallel SCSI Configuration Menu allows the configuration of the SCSI discovery mode, SCSI bus reset, termination mode, tape backup settings, and default current map.

Figure 43 is an illustration of the Parallel SCSI Configuration Menu.

```

Parallel SCSI Configuration Menu
X.XX.XX XXXXXX XXXXXX-XXX_XXXXXXXXXXXXXXXXXX
01/06/2003 08:57:25

Current SCSI Configuration - Bus 0

Initiator           : Enabled
Discovery           : Enabled
Bus Reset on Boot   : Enabled
Discovery delay time : 2 seconds
Internal Termination : Enabled
Buffered Tape Writes : Disabled
Current Default Map  : 'Auto Assigned'

1) Edit Initiator and Target Settings
2) Enable/Disable SCSI Discovery
3) Enable/Disable SCSI Reset on Boot
4) Set Discovery Delay Time
5) Set SCSI Termination Mode
6) Edit SCSI Target Override Settings
7) Enable/Disable Buffered Tape Writes
8) Change Default Map Value
X) Return to previous menu

Command, <enter> for next SCSI bus >

```

Figure 43: SCSI Configuration menu

Current settings for the selected SCSI bus are displayed.



Caution: If these configuration settings are incorrectly set, processing difficulties may occur. Before changing these settings, evaluate the need for the change and verify the desired setting. HP recommends backing up the router configuration to an external file before making changes to these settings.

SCSI Configuration Menu options:

- **1) Edit Initiator and Target Settings** changes the SCSI Initiator and Target settings.

The SCSI Initiator and Target Menu sub-screen is displayed, listing the following options:

- **1) Enable/Disable SCSI Initiator** enables or disables the SCSI Initiator. Options are **Enabled** and **Disabled**.
- **2) Select primary and select/enable alternate SCSI ID** sets the primary and alternate initiator SCSI IDs (defaults: primary = 7; alternate = none). These should be unique IDs on the bus.
- **3) Add Target ID** or
- **4) Remove Target ID** adds or removes a Target ID. This adds an ID for a Fibre Channel device that responds to operation requests from the SCSI initiator.

Note: Target IDs must be setup prior to mapping devices on the SCSI bus.

Note: Do not enable Target IDs unless a SCSI initiator on the bus wants to use Fibre Channel devices. This type of configuration is known as a Target Mode configuration.

- **2) Enable/Disable SCSI Discovery** enables or disables the Discovery Mode.
- **3) Enable/Disable SCSI Reset on Boot** enables or disables automatic bus resets after a reboot.

When enabled, the router will automatically reset SCSI buses during initial power ups and reboots.



Caution: If these configuration settings are incorrectly set, processing difficulties may occur. Before changing these settings, evaluate the need for the change and verify the desired setting. HP recommends backing up the router configuration to an external file before making changes to these settings.

- **4) Set Discovery Delay Time** sets the length of time the router waits after a power-up or reboot before discovering SCSI devices.

Note: This value should be set to no less than 250ms, according to the SCSI standard for Reset-to-Selection Time. HP recommends setting the value to at least 30 seconds to ensure all SCSI devices complete their individual POST.

- **5) Set SCSI Termination Mode** enables or disables the SCSI termination mode.
- **6) Edit SCSI Target Override Settings** changes the SCSI Target overrides.
SCSI Parameter Override Configuration Menu options:
 - **1) Toggle CDB Length Override:** enabled or disabled.
If enabled, the following configuration options are displayed:
 - CDB Group 6 Length Default** (default = 0) can be set to 0, 6, 10, or 12.
 - CDB Group 7 Length Default** (default = 0) can be set to 0, 6, 10, or 12.
 - **2) Toggle Wide Negotiation:** enabled or disabled.
 - **3) Toggle Synchronous Negotiation:** enabled or disabled.
If enabled, the following configuration options are displayed:
 - Synchronous Period** (default = 40) is the maximum number of seconds allowed for negotiation.
 - Synchronous Offset** (default =16) is the maximum variation in transfer rate that can be negotiated in MB/s.
 - **4) Toggle Synchronous Parameter Override:** enabled or disabled.
- **7) Enable/Disable Buffered Tape Writes** (default: Enabled) enables or disables Buffered Tape Writes.
Buffered Tape Writes return status on consecutive write commands before the tape device receives data, to enhance performance.
- **8) Change Default Map Value** sets the default map to use for the bus.
Mapping modes can be Auto-Assigned (default), Indexed, or SCC.
For more information about addressing methods, see Appendix C, "[Addressing Methods and Table Structures.](#)"
- **X) Return to previous menu** returns to previous menu.
- Command **<Enter>** scrolls to the next SCSI bus.

Device Mapping

Each physical port/bus on the router can have the following maps:

Table 8: Device Map Types

Map Type	System/User Generated	Fibre Channel or SCSI
Auto Assigned	System	Fibre Channel and SCSI
Indexed (default)	System	Fibre Channel and SCSI
Port <0> Device	System	Fibre Channel
SCC	System	Fibre Channel

Each map has a unique name and map ID; one of the maps must be identified as the “current” map for the router to use.

In the Configuration Menu, choose **5) Device Mapping** to manipulate maps and associate the selected hosts with a particular map. Maps are viewed, edited, and deleted, in the Device Mapping Menu.

[Figure 44](#) is an example of the Device Mapping Configuration Menu.

```

Device Mapping Main Menu
X.XX.XX .....XX.....-XXX_XXXXXXXXXXXXXXXXX
01/06/2003 09:01:15

Current Default Map for FCP Port 0 - Name ' Indexed'

1) Select Current Map
2) Display Current Map
3) Edit Current Map
4) Edit Host List for Current Map
5) Display Device List

X) Return to previous menu

Command, <enter> for next port/bus >

```

Figure 44: Device Mapping Configuration menu

Device Mapping Configuration Menu options:

- **1) Select Current Map** indicates which map is to be the current map.
- **2) Display Current Map** displays the current map.
- **3) Edit Current Map** changes current map settings.
- **4) Edit Host List for Current Map** changes the host information for the current map.
- **5) Display Device List** displays the device list.
- **X) Return to previous menu** returns to previous menu.
- **Command, <Enter> for next port/bus** to scroll to the next SCSI bus, press **Enter**.

Because each menu option includes a menu or sample screen display, each menu option is discussed in the following separate sections.

Selecting the Current Map

In the Device Mapping Configuration Menu, choose **1) Select Current Map** to select the current map for each port or bus.

When this option is selected, the Select Current Map screen is displayed. The current map assignment is displayed at the top of the screen. [Figure 45](#) is an illustration of the Select Current Map screen for a Fibre Channel port.

```

                                Select Current Map
                                X.XX.XX XXXXXX XXXXXX-XXX_XXXXXXXXXXXXXXXXXX
                                01/06/2003 08:57:36
+-----+-----+-----+-----+-----+
| MAP # | Protocol | Port |          Map Name          |
+-----+-----+-----+-----+-----+
|   1   | FCP      | 0   |          Indexed          |
|   2   | FCP      | 0   |        Auto Assigned      |
|   3   | FCP      | 0   |          SCC Map          |
+-----+-----+-----+-----+-----+
Page # 1 out of 1 pages.
Total Number of Maps = 3
Enter (N=Next, P=Prev, Number=Select, X=Exit) >

```

Figure 45: Select Current Map screen



Caution: If this configuration setting is incorrectly set, processing difficulties may occur. Before changing this setting, evaluate the need for the change and verify the desired setting. HP recommends backing up the router configuration to an external file before making changes to this setting.

To indicate which map is to be the current map, type the number that corresponds to the desired map.

Displaying the Current Map

In the Device Mapping Configuration Menu, choose **2) Display Current Map** to view the entries for the current Map.

The Current Map Display screen is displayed.

Depending on whether a Fibre Channel map or a SCSI map was selected, the screen display will differ.

[Figure 46](#) and [Figure 47](#) are illustrations of the different screen displays for Fibre Channel maps and SCSI maps.

```

Current Map Display
X.XX.XX XXXXXX XXXXXX-XXX_XXXXXXXXXXXXXXXXXX
01/06/2003 08:57:46

Port Map Display

Map: FCP Port 0: Name 'Indexed'
+-----+-----+-----+-----+-----+-----+-----+-----+
| LUN || Prtl | Port | TYPE | STAT | Protocol Specific Information |
+-----+-----+-----+-----+-----+-----+-----+-----+
|  0 || SCSI |   1 | TAPE |  UP  | Target= 3  Lun=  0           |
|  1 || SCSI |   1 | DISK |  UP  | Target= 4  Lun=  0           |
|  2 || SCSI |   1 | DISK |  UP  | Target= 5  Lun=  0           |
|  3 || SCSI |   1 | DISK |  UP  | Target= 6  Lun=  0           |
|  4 || SCSI |   5 | TAPE |  UP  | Target= 1  Lun=  0           |
+-----+-----+-----+-----+-----+-----+-----+-----+

Page # 1 out of 1 pages.
Number of entries in the Map = 5
Enter (N=Next, P=Prev, X=Exit) >

```

Figure 46: FCP Current Map Display screen

Note: The entire list may not fit on one screen. Press **N** or **P** to go back and forth between screens.

```

Current Map Display
X.XX.XX XXXXXX XXXXXX-XXX_XXXXXXXXXXXXXXXXX
01/06/2003 08:57:56

Port Map Display
Map: SCSI Port 7: Name 'Indexed'
-----+-----+-----+-----+-----+-----+-----+-----+-----+
| Trgt | LUN || Prtl | Port | TYPE | STAT | Protocol Specific Information |
-----+-----+-----+-----+-----+-----+-----+-----+
| 1 | 0 || FCP | 1 | DISK | UP | WWN=0x22000020374F9BB7 Lun= 0 |
| 1 | 1 || FCP | 1 | DISK | UP | WWN=0x500507650543E065 Lun= 0 |
| 1 | 2 || FCP | 1 | TAPE | UP | WWN=ox65225211224EAO25 Lun= 0 |
| 1 | 3 || FCP | 1 | DISK | UP | WWN=ox9545626EF2077025 Lun= 0 |
| 1 | 4 || FCP | 5 | TAPE | UP | WWN=ox25245641AA02EA29 Lun= 0 |
-----+-----+-----+-----+-----+-----+-----+-----+
Page # 1 out of 1 pages.
Number of entries in the Map = 5
Enter (N=Next, P=Prev, X=Exit) >

```

Figure 47: SCSI Current Map Display screen

Editing the Current Map

In the Device Mapping Configuration Menu, choose **5) Edit Current Map** to edit the current map.

The Map Edit Menu subscreen is displayed.

[Figure 48](#) is an illustration of the Map Edit Menu.

```

Map Edit Menu
X.XX.XX XXXXXX XXXXXX-XXX_XXXXXXXXXXXXXXXXX
01/06/2003 09:04:19

Current Map: FCP Port 0 - Name 'Indexed'

1) Edit Name
2) Edit Map Entries
3) Clear Map
4) Fill Map

X) Return to previous menu

Command >

```

Figure 48: Map Edit menu

Note: Auto-Assigned and SCC Maps cannot be edited.

Map Edit Menu options:

- 1) **Edit Name** changes the name of the current map.
- 2) **Edit Map Entries** changes the content of the current map.
- 3) **Clear Map** erases all entries from the current map.
- 4) **Fill Map** automatically completes the entries for the current map.

Each editing option is discussed in the following sections.

Changing the Name of the Current Map

To change the name of the current map, in the Map Edit Menu, select **1) Edit Name**. Enter the new name at the prompt.

Note: Only user-defined map names can be changed.

Editing the Map Entries of the Current Map

To edit the details of the current map, in the Map Edit Menu, choose **2) Edit Map Entries**. This editing screen allows the user to navigate up and down the map entries and create or remove entries. Device lists are also available to make it easier to identify the device to be mapped.

Note: Mapping a device to its native port/bus is not allowed. The information needed to create entries is protocol/port dependent.

Although the options are the same for editing Fibre Channel and SCSI maps, the screen displays differ.

[Figure 49](#) is an example screen display for Fibre Channel maps and [Figure 50](#) is an example screen display for a SCSI map.

```

                                Edit Map Entries
                                X.XX.XX XXXXXX XXXXXX-XXX_XXXXXXXXXXXXXXXXXX
                                01/06/2003 08:58:06

Port Map Edit Display

Map: FCP Port 0: Name 'Indexed'
+-----+-----+-----+-----+-----+-----+-----+-----+
| LUN || Prtl | Port | TYPE | STAT | Protocol Specific Information |
+-----+-----+-----+-----+-----+-----+-----+
|  0 || SCSI |   1 | TAPE | UP   | Target= 3  Lun=  0 |
|  1 || SCSI |   1 | DISK | UP   | Target= 4  Lun=  0 |
|  2 || SCSI |   1 | DISK | UP   | Target= 5  Lun=  0 |
|  3 || SCSI |   1 | DISK | UP   | Target= 6  Lun=  0 |
|  4 || SCSI |   5 | TAPE | UP   | Target= 1  Lun=  0 |
+-----+-----+-----+-----+-----+-----+-----+

Page # 1 out of 1 pages.
Number of entries in the Map = 5

Enter (N=Next,P=Prev,A=Add,C=Create,R=RemoveGaps,D=Delete,X=Exit) >

```

Figure 49: Edit Map Entries for a Fibre Channel map

```

                                Edit Map Entries
                                X.XX.XX XXXXXX XXXXXX-XXX_XXXXXXXXXXXXXXXXXX
                                01/06/2003 08:58:16

Port Map Edit Display

Map: SCSI Port 7: Name 'Indexed'
+-----+-----+-----+-----+-----+-----+-----+-----+
| Trgt | LUN || Prtl | Port | TYPE | STAT | Protocol Specific Information |
+-----+-----+-----+-----+-----+-----+-----+
|  1 |  0 || FCP |   1 | DISK | UP   | WWN=0x22000020374F9BB7 Lun=  0 |
|  1 |  1 || FCP |   1 | DISK | UP   | WWN=0x500507650543E065 Lun=  0 |
|  1 |  2 || FCP |   0 | TAPE | UP   | WWN=0x65225211224EA025 Lun=  0 |
|  1 |  3 || FCP |   0 | DISK | UP   | WWN=0x9545626EF2077025 Lun=  0 |
|  1 |  4 || FCP |   1 | TAPE | UP   | WWN=0x25245641AA02EA29 Lun=  0 |
+-----+-----+-----+-----+-----+-----+-----+

Page # 1 out of 1 pages.
Number of entries in the Map = 5

Enter (N=Next,P=Prev,A=Add,C=Create,R=RemoveGaps,D=Delete,X=Exit) >

```

Figure 50: Edit Map Entries for a SCSI map

Edit Map Entries options:

- **Next (N)** scrolls down the list of map entries.
- **Previous (P)** scrolls up the list of map entries.
- **Add (A)** adds new map entries.

- **Create (C)** creates a new map entry for a newly added device.
- **Remove Gaps (R)** removes gaps in the listed sequence of LUNs.
- **Delete (D)** deletes a map entry.
- **Exit (X)** returns to the previous menu.

Scrolling between Display Pages of the Edit Map Entries Screen

To scroll up and down the map entries, select **P** or **N**.

Adding a Map Entry to a Fibre Channel Map

To add a new entry to a Fibre Channel map:

1. In the Map Edit Entries screen, select **Add (A)**.
2. Enter the desired LUN ID.

If the selected LUN is already present in the map, a prompt is displayed that asks to either confirm the override or enter different address information.

A device selection list is automatically generated.

Note: Devices cannot be mapped to their native port.

3. To select the map entry to edit, enter the number from the left-hand column of the Port Map Edit Display screen.

A Device List is displayed.

```

                                Device List
                                X.XX.XX XXXXXX XXXXXX-XXX_XXXXXXXXXXXXXXXXXX
                                01/06/2003 08:58:26
FCP Port 1 Device List:
+-----+-----+-----+-----+-----+-----+
| Num | LUN | TYPE | State | Port WWN | Node WWN |
+-----+-----+-----+-----+-----+-----+
|  1  | -   | -   | -   | 0x22000020374F9BB7 | 0x20000020374F9BB7 |
|  2  | 0   | DISK | ACTIVE | 0x22000020374F9BB7 | 0x20000020374F9BB7 |
|  3  | -   | -   | -   | 0x500507650543E065 | 0x500507650503E065 |
|  4  | 0   | DISK | ACTIVE | 0x500507650543E065 | 0x500507650503E065 |
+-----+-----+-----+-----+-----+-----+
Page # 1 out of 1 pages.
Number of entries in the device table = 4

Enter (Number=Select, N=Next, P=Prev, X=Exit) >

```

Figure 51: Device List generated for a Fibre Channel port

4. In the Device List, to add a listed device to the map, enter the number from the “Num” column.

If the selected device is already mapped, an error message will appear, warning the user about adding a duplicate device.

Adding a Map Entry to a SCSI Map

To add a new entry to a SCSI map:

1. In the Edit Map Entries screen, select **Add (A)**.
2. Enter a Target/LUN ID combination.

If the selected Target/LUN is already present in the map, a prompt is displayed that asks to either confirm the override or enter different address information.

A device selection list is automatically generated.

Note: Devices cannot be mapped to their native port.

Note: A target ID must be defined in the SCSI Configuration to add devices.

3. In the Device List, to add a device to the map, enter the number from the “Num” column. If the selected device is already mapped, an error message will appear, warning about adding a duplicate device.

Note: If a device with LUN = “-” is selected, all LUNs for this Target will be added to the map.

Creating a Map Entry for a Fibre Channel Map

To pre-enter a map entry for devices that are not yet online, select **Create (C)**.

Note: All essential information about the device must be known.

A series of questions is displayed. The questions will vary based on the “current” map protocol. Required information includes the LUN address, protocol, port, device name, and device type.

Figure 52 is an example of the screen display when creating an entry for a Fibre Channel map.

```
Enter desired lun address > 1

Select Protocol (0 - SCSI, X=Cancel) > 0
Select SCSI Port: Port# = ? (0-7,X=Cancel) > 2
Enter desired Device Name (could be empty) >

DISK_DEVICE      - 0,  TAPE_DEVICE      - 1
PRINTER_DEVICE   - 2,  PROCESSOR_DEVICE - 3
WORM_DEVICE      - 4,  CDROM_DEVICE    - 5
SCANNER_DEVICE   - 6,  OPTICAL_DEVICE   - 7
MEDIUM_CHGR_DEVICE - 8,  COMM_DEVICE      - 9
ARRAY_CTLR_DEVICE - 12, ENCLOSURE_SRV_DEVICE - 13

Enter desired Device Type > 1

Enter device target id > 5

Enter device lun id > 0
```

Figure 52: Creating a map entry for a Fibre Channel map

Note: If the device being added is a SCSI device, the Target ID and LUN ID must be entered. The Target ID must already be defined in the SCSI configuration.

Creating an Entry for a SCSI Map

To pre-enter a map entry for devices that are not yet online, select **Create (C)**.

Note: All essential information about the device must be known.

A series of questions is displayed. The questions will vary based on the “Current” map protocol. Required information includes the Target ID and LUN address, protocol, port, device name, and device type must be entered.

Figure 53 is an example of the screen display when creating an entry for a SCSI map.

```
Choose desired Target SCSI ID from( 1 2 3 ) > 1

Enter desired lun address > 0

Select Protocol (0 - FCP, X=Cancel) > 0
Select FCP Port: Port# = ? (0-1,X=Cancel) > 0
Enter desired Device Name (could be empty) >

DISK_DEVICE      - 0, TAPE_DEVICE      - 1
PRINTER_DEVICE  - 2, PROCESSOR_DEVICE - 3
WORM_DEVICE     - 4, CDROM_DEVICE     - 5
SCANNER_DEVICE  - 6, OPTICAL_DEVICE   - 7
MEDIUM_CHGR_DEVICE - 8, COMM_DEVICE   - 9
ARRAY_CTLR_DEVICE - 12, ENCLOSURE_SRV_DEVICE - 13

Enter desired Device Type > 0

Enter Port WWN High > 12321232

Enter Port WWN Low > 02563265

Enter Node WWN High > 26589500

Enter Node WWN Low > 21548754

Enter device lun id > 0
```

Figure 53: Creating an entry for a SCSI map

Note: If the device being added is a Fibre Channel device, the Node WWN, Port WWN, and LUN ID must be entered.

Note: If this device is a duplicate of a device currently present in the device list, an error message will be displayed.

Removing Gaps in the Map

To remove any incremental gaps in the sequence of LUNs listed in the table, in the Edit Map Entries screen, select **Remove (R)**.

As the system removes any gaps from the table, the LUNs are renumbered in sequential order, starting with LUN 0.

Note: Some operating systems require gaps be removed in the mapping table in order to detect all devices.

Deleting a Map Entry

To delete an entry from a map, in the Edit Map Entries screen, select **Delete (D)**.

For Fibre Channel maps, at the prompt, either enter the LUN ID of the LUN to delete or enter **D** to delete multiple LUNs.

For SCSI maps, at the prompt, enter the Target ID and LUN ID of the LUN to delete or enter **D** to delete multiple LUNs.

Clearing the Entries from the Current Map

To remove all entries from the current map, in the Edit Map Entries screen, select **3) Clear Map**. A confirmation prompt is displayed.

Filling in the Current Map

To instruct the system to automatically fill in the current map, in the Edit Map Entries screen, select **4) Fill Map**.

All new devices are added to the end of the current map. After this operation is completed, the Edit Map Entries Menu is redisplayed.

Note: Devices marked DOWN are not mapped.

Editing the Host List for the Current Map

In the Device Mapping Configuration Menu, choose **7) Edit Host List for Current Map** to edit the host list for the current map.

The current map can be associated with hosts available in the host list on the same port where the map is defined. Initially all hosts are associated with an Auto Assigned map. These are built at runtime hosts and cannot be edited or deleted.

Although the options are the same for FCP maps and SCSI maps, the screen display differs. [Figure 54](#) and [Figure 55](#) are examples of the Host List Display screens for FCP and SCSI maps.

```

Host List Edit Display
X.XX.XX XXXXXX XXXXXX-XXX_XXXXXXXXXXXXXXXXXX
01/06/2003 08:58:38

Current Map: FCP Port 0 - Name 'Indexed'
FCP Port# 0 Host List:
+-----+-----+-----+-----+-----+
| N# | Port WWN | Node WWN | Host Name | Active Map Name |
+-----+-----+-----+-----+-----+
| 1 | Hi Ox210000E0 | Hi Ox200000E0 | (built at runtime) | Auto Assigned |
| | Lo Ox8B02C20E | Lo Ox8B02C20E | PortID = Ox0000EF | |
+-----+-----+-----+-----+-----+

Page # 1 out of 1 pages.
Total Number of Hosts = 1
Select Host Number(1 - 1) to associate host with the Current Map
Enter (N=Next, P=Prev, A=Add, D=Delete, E=Edit, X=Exit) >

```

Figure 54: Host List Display for Fibre Channel maps

```

Host List Edit Display
X.XX.XX XXXXXX XXXXXX-XXX_XXXXXXXXXXXXXXXXXX
01/06/2003 08:58:56

Current Map: SCSI Port 0 - Name 'Indexed'
SCSI Port# 0 Host List:
+-----+-----+-----+-----+-----+
| Num | Initiator ID | Host Name | Active Map Name |
+-----+-----+-----+-----+-----+
| 1 | 7 | Scsi Host | Default |
+-----+-----+-----+-----+-----+

Page # 1 out of 1 pages.
Total Number of Hosts = 1
Select Host Number(1 - 1) to associate host with the Current Map
Enter (N=Next, P=Prev, A=Add, D=Delete, E=Edit, X=Exit) >

```

Figure 55: Host List Display for SCSI maps

Host List Edit Display options:

- **Next (N)** scrolls down the Host List.
- **Previous (P)** scrolls up the Host List.
- **Add (A)** adds a new host to the Host List.
- **Delete (D)** deletes a host from the Host List.
- **Edit (E)** edits host information.
- **Exit (X)** returns to the previous menu.

Each of the options is discussed in the following paragraphs.

Scrolling between the Display Pages of the Host List Edit Screen

To scroll up and down the host entries, select **P** or **N**.

Selecting a Host

To select a host from the list, enter the number displayed in the “N#” or the “Num” column at the left of the screen.

Adding a Host to the Host List

To add a host to the Host List, select **Add (A)**.

If the host is an FCP host, the Host Name, Host ID, port WWN, and Node WWN for FCP host must be entered. (WWN values are hexadecimal.)

Figure 56 is an example of the screen display when adding a host to the Host List of an FCP host.

```
Enter desired Host Name > Fcp Host
Do you know Port ID of the Host?(y/n) > y

Enter Host ID of the host > 0000ef

Enter the new host's Port WWN High > 210000E0

Enter the new host's Port WWN Low > 8B02C20E

Enter the new host's Node WWN High > 200000E0

Enter the new host's Node WWN Low > 8B02C20E
Host was successfully added to the host list!!!
```

Figure 56: Adding a host to the host list - FCP host

If the host is a SCSI host, the host name and the initiator ID must be entered.

Deleting a Host from the Host List

To remove a host from the Host List, select **Delete (D)**. After entering the number of the host to delete, a confirmation prompt is displayed.

Editing Host information

To change host information, select **Edit (E)**.

Current host information is displayed on the screen. The system will display a series of prompts, allowing changes to be entered.

Note: To retain the current information for a prompt, press **Enter** at the prompt.

Figure 57 is an example of editing host information for a Fibre Channel port.

```

Host List Edit Display
X.XX.XX XXXXXX XXXXXX-XXX-XXXXXXXXXXXXXXXXX
01/06/2003 08:58:58

Current Map: FCP Port 0 - Name 'Indexed'
FCP Port# 0 Host List:
+-----+-----+-----+-----+-----+
| N# | Port WWN | Node WWN | Host Name | Active Map Name |
+-----+-----+-----+-----+-----+
| 1 | Hi Ox210000E0 | Hi Ox200000E0 | | Default |
| | Lo Ox8B02C20E | Lo Ox8B02C20E | PortID = Ox0000EF | |
+-----+-----+-----+-----+-----+

Page # 1 out of 1 pages.
Total Number of Hosts = 1
Select Host Number(1 - 1) to associate host with the Current Map
Enter (N=Next, P=Prev, A=Add, D=Delete, E=Edit, X=Exit) > e

Select Host to edit (X=Cancel) > 1
Old Host Name:
Enter desired new name (<enter> = use old name) > New FCP Host

Old host's Port WWN High: Ox210000E0
Enter desired Port WWN High(<enter> = use old Port WWN High) >

Old host's Port WWN Low: Ox8B02C20E
Enter desired Port WWN Low(<enter> = use old Port WWN Low) >

Old host's Node WWN High: Ox200000E0
Enter desired Node WWN High(<enter> = use old Node WWN High) >

Old host's Node WWN Low: Ox8B02C20E
Enter desired Node WWN Low(<enter> = use old Node WWN Low) >

```

Figure 57: Editing host information on a Fibre Channel port

Figure 58 is an example of editing host information for a SCSI bus.

```

Host List Edit Display
X.XX.XX XXXXXX XXXXXX-XXX_XXXXXXXXXXXXXXXXXX
01/06/2003 08:59:18

Current Map: SCSI Port 0 - Name 'Indexed'
SCSI Port# 0 Host List:
+-----+-----+-----+-----+
| Num | Initiator ID | Host Name | Active Map Name |
+-----+-----+-----+-----+
| 1 | 7 | Scsi Host | Default |
+-----+-----+-----+-----+

Page # 1 out of 1 pages.
Total Number of Hosts = 1
Select Host Number(1 - 1) to associate host with the Current Map
Enter (N=Next, P=Prev, A=Add, D=Delete, E=Edit, X=Exit) > e
Select Host to edit (X=Cancel) > 1
Old Host Name: Scsi Host
Enter desired new name (<enter> = use old name) > New Name

Old Initiator ID: 7
Enter desired Initiator ID(<enter> = use old Initiator ID) >

```

Figure 58: Editing host information for a SCSI bus

Displaying the Entire Device List

In the Device Mapping Configuration Menu, choose **8) Display Device List** to view the entire device list for all buses and ports.

The Entire Device List screen is displayed.

Figure 59 is an illustration of the Entire Device screen.

```

Entire Device List
X.XX.XX XXXXXX XXXXXX-XXX_XXXXXXXXXXXXXXXXXX
01/06/2003 08:59:28
-----+-----+-----+-----+-----+-----+-----+-----+-----+-----+
| N# || PrtI | Port | TYPE | STAT | Protocol Specific Information | Map Cnt |
-----+-----+-----+-----+-----+-----+-----+-----+-----+-----+
| 1 || SCSI | 1 | TAPE | UP | Target= 3 Lun= 0 | 2 |
| 2 || SCSI | 1 | DISK | UP | Target= 4 Lun= 0 | 2 |
| 3 || SCSI | 1 | DISK | UP | Target= 5 Lun= 0 | 2 |
| 4 || SCSI | 1 | DISK | UP | Target= 6 Lun= 0 | 2 |
| 5 || SCSI | 2 | TAPE | DOWN | Target= 5 Lun= 0 | 1 |
| 6 || SCSI | 5 | TAPE | UP | Target= 1 Lun= 0 | 2 |
| 7 || SCSI | 5 | DISK | UP | Target= 2 Lun= 0 | 2 |
| 8 || FCP | 0 | DISK | DOWN | WWN= 0x1545210015326500 Lun= 0 | 1 |
| 9 || FCP | 1 | DISK | UP | WWN= 0x22000020374F9BB7 Lun= 0 | 1 |
| 10 || FCP | 1 | DISK | UP | WWN= 0x500507650543E065 Lun= 0 | 1 |
-----+-----+-----+-----+-----+-----+-----+-----+-----+-----+
Page # 1 out of 1 pages.
Number of entries in the device table = 10

Enter (N=Next, P=Prev, X=Exit) >

```

Figure 59: Entire Device List screen

Note: The entire list of maps may not fit on one screen. Select **N** or **P** to go back and forth between screens displaying more maps. Select **X** to return to the previous menu.

Trace and Event Settings Configuration

In the Configuration Menu, choose **5) Trace and Event Settings Configuration** to view and change Trace and Event settings. When this option is selected, the following menu is displayed.

```

Utility Settings
X.XX.XX XXXXXX XXXXXX-XXX_XXXXXXXXXXXXXXXXXX
01/06/2003 08:59:38

1) Trace Settings Configuration
2) Event Settings Configuration

X) Return to previous menu

```

Figure 60: Utility Settings (trace settings) menu

Trace Settings Menu options:

- 1) **Trace Settings Configuration** configures the trace settings.
- 2) **Event Settings Configuration** configures the event settings.

Each of these options is discussed in the following sections.

Configuring Trace Settings

In the Utility Trace Settings Menu, **1) Trace Setting Configuration** is used to modify trace levels. Two pages of trace level settings are displayed.

[Figure 61](#) and [Figure 62](#) are illustrations of the two Trace Settings screens.

Note: Trace settings should not be modified in normal operation; performance degradation may result.

1. To change any of the settings in these screens, enter the number that corresponds to the option that needs to be changed.
The current setting is toggled to either **On** or **Off**.
2. Repeat Step 2 for each setting that needs to be changed in the page.
3. Before leaving the page, activate the new setting by entering **U) Update Current Operating Trace Levels**.

This option forces the currently displayed trace settings to become effective immediately, without requiring a reboot or power cycle.

```

                                Trace Settings
                                X.XX.XX XXXXXX XXXXXX-XXX_XXXXXXXXXXXXXXXXXX
                                01/06/2003 08:59:48

0) General Errors      : ON
1) FCP Driver         : OFF
2) FCP Transport      : OFF
3) FCP Management     : OFF
4) PS Transport       : OFF
5) PS Management      : OFF
6) PS Driver          : OFF

U) Update Current Operating Trace Levels
X) Return to previous menu

Enter the trace level index, <enter> for next page >

```

Figure 61: Trace Settings screen

4. Press **Enter** to display the second Trace Settings page.
Figure 62 is an illustration of the second Trace Settings page.
5. If needed, change the settings in the second Trace Settings page.

Note: Be sure to set the clock and date in the Real Time Clock Configuration Menu so that event logging is accurate.

```
Trace Settings
X.XX.XX XXXXXX XXXXXX-XXX_XXXXXXXXXXXXXXXXXX
01/06/2003 08:59:58

0) SG List           : OFF
1) Timing            : OFF
2) FCP/RMI          : OFF
3) AF                : OFF
4) INBAND           : OFF

U) Update Current Operating Trace Levels
X) Return to previous menu

Enter the trace level index, <enter> for next page >
```

Figure 62: Trace Settings screen, continued

Configuring Event Settings

In the Utility Trace Settings Menu, **2) Event Setting Configuration** is used to modify event filters:

The following Event Filter Settings screen is displayed.

```
Event Filter Settings
X.XX.XX XXXXXX XXXXXX-XXX_XXXXXXXXXXXXXXXXXX
01/06/2003 09:00:08

1) *Log All Events      2) Disable Event Logging
3) Error Events        4) Notify Events

U) Update Current Operating Trace Levels
X) Return to Previous Menu

Enter Event Threshold <1-4> >
```

Figure 63: Event Filter settings

Note: The asterisk in the screen display denotes the current setting.

1. To change any of the settings in this screen, enter the number of the desired setting (**1**, **2**, **3**, or **4**) that corresponds to the option that needs to be changed.

Settings include:

- **1) Log All Events** (default)
 - **2) Disable Event Logging**
 - **3) Error Events**
 - **4) Notify Events**
2. Before leaving the page, activate the new setting by entering **U) Update Current Operating Trace levels**.
 3. This option forces the currently displayed trace settings to become effective immediately, without requiring a reboot or power cycle.

Note: Set the clock and date in the Real Time Clock Configuration Menu so that event logging is accurate.

Real-Time Clock Configuration

In the Configuration Menu, choose **7) Real-time Clock Configuration** to change the system time and date.

[Figure 64](#) is an illustration of the System Clock Setup Menu.

```

System Clock Setup Menu
X.XX.XX XXXXXX XXXXXX-XX-XXXXXXXXXXXXXXXXX
      01/06/2003 09:00:18

TUESDAY, Date: 01/06/2003, Time: 09:00:18
1) Set clock
X) Return to previous menu

```

Figure 64: Clock Setup menu

1. To change the date or time, select **1) Set Clock**.
2. A series of prompts are displayed, allowing setup of:
 - 24-hour time
 - Current date
 - Current day of the week

Active Fabric Configuration

In the Configuration Menu, select **8) Active Fabric Configuration** to enter Active Fabric options.

[Figure 65](#) is an illustration of the Active Fabric Configuration Menu.

```
Active Fabric Configuration Menu
X.XX.XX XXXXXX XXXXXX-XXX_XXXXXXXXXXXXXXXX
01/06/2003 09:21:54

Current Active Fabric Configuration:

Server Free Backup Mode           : DISABLED
Number of Controller LUNS (0-4)   : 1

1) Change number of Controller LUNs

NOTE : FC DISCOVERY mode must be enabled
       when Server Free Backup Mode is ON
       to access Fibre Channel targets.

X) Return to previous menu
```

Figure 65: Active Fabric Configuration menu

Active Fabric Configuration Menu options:

- **1) Change the number of controller LUNs (default: 1) changes the number of controller LUNs.**

This setting is a number in the range of 0 through 4.

For more information on controller LUN commands, see Appendix B, "[Controller LUN Commands](#)."

Save Configuration

In the Configuration Menu, **A) Save Configuration** is used to save any configuration changes.

The current configuration state is saved in FLASH, which updates the previous configuration. This configuration is retained across future device resets or power cycles.

Restore Last Saved Configuration

In the Configuration Menu, **B) Restore Last Saved Configuration** is used to revert to the previous configuration. This can be useful when configuration changes have been made, and the user wishes to return to the previous configuration.

Reset and Save Configuration to Factory Defaults

In the Configuration Menu, choose **C) Reset and Save Configuration** to reset the router configuration to its initial settings (factory default).

System Utilities Menu

Accessed from the router Main Menu, the **System Utilities Menu** is primarily used to view system information.

To access the System Utilities Menu, in the router Main Menu, choose **2) System Utilities**.

Figure 66 is an illustration of the System Utility Menu.

```
System Utility Menu
X.XX.XX XXXXXX XXXXXX-XXX_XXXXXXXXXXXXXXXXXX
01/06/2003 09:00:31

1) System Statistics Menu
2) Event Log
3) Enter System Diagnostics Mode
4) Special Fibre Channel Link States

X) Return to main menu
```

Figure 66: System Utility menu

System Utility Menu options:

- **1) System Statistics Menu** displays a variety of system status information.
- **2) Event Log** displays the system Event Log.
- **3) Enter System Diagnostics Mode** performs Ethernet, SCSI, and Fibre Channel connection tests.

Note: This option is reserved for service personnel and is not documented.

- **4) Special Fibre Channel Link States** performs special diagnostics.

This option is reserved for service personnel and is not documented.

The System Statistics Menu and the Event Log options are discussed in the following separate sections.

System Statistics

In the System Utility Menu, select **1) System Statistics Menu** to view system status information.

[Figure 67](#) is an illustration of the System Status/Statistics Menu.

```
System Status/Statistics Menu
X.XX.XX XXXXXX XXXXXX-XXX_XXXXXXXXXXXXXXXXXX
01/06/2003 09:00:33

1) Display System Status
2) Display Fibre Channel Protocol Status
3) Display Parallel SCSI Protocol Status
X) Return to main menu
```

Figure 67: System Statistics menu

System Statistics Menu options:

- **1) Display System Status** displays router status information.
- **2) Display Fibre Channel Protocol Status** displays Fibre Channel status information.
- **3) Display Parallel SCSI Protocol Status** displays SCSI status information.

Because each option offers a variety of display screens, each of these menu options is discussed in the following separate subsections.

Viewing System Status Information

In the System Statistics Menu, choose **1) Display System Status** to view a variety of status information, including memory statistics, current active tasks, and stack usage.

The System Status Menu is displayed.

[Figure 68](#) is an illustration of the System Status Menu.

```
System Status Menu
X.XX.XX XXXXXX XXXXXX-XXX_XXXXXXXXXXXXXXXXXX
01/06/2003 09:00:36

1) Display memory statistics
2) Display active tasks
3) Display stack usage
4) Display SCSI Protocol Resources
X) Return to previous menu
```

Figure 68: System Status menu

System Status Menu options:

- **1) Display memory statistics** displays memory usage information
- **2) Display active tasks** displays a list of current tasks.
- **3) Display stack usage** displays current stack information.
- **4) Display SCSI Protocol Resources** displays SCSI protocol information.

Viewing Fibre Channel Status Information

To display Fibre Channel status information, in the System Statistics Menu, choose **2) Display Fibre Channel Protocol Status**. The Fibre Channel Status Menu is displayed. [Figure 69](#) is an illustration of the Fibre Channel Status Menu.

```
Fibre Channel Status Menu
X.XX.XX XXXXXX XXXXXX-XXX_XXXXXXXXXXXXXXXXXX
01/06/2003 09:00:39

1) Display Fibre Channel Link Status
2) Display Attached Fibre Channel Devices
3) Display FC Resource Status
4) Display FC Driver Resource Status
X) Return to main menu

Command >
```

Figure 69: Fibre Channel Status menu

The Fibre Channel Status Menu lists the following options:

- **1) Display Fibre Channel Link Status** displays Fibre Channel link information.

- **2) Display Attached Fibre Channel Devices** displays a list of devices attached to this Fibre Channel port.
- **3) Display Fibre Channel Resource Status** displays Fibre Channel resource transport information.
- **4) Display Fibre Channel Driver Resource Status** displays Fibre Channel driver information.

Each menu option and example screen displays are discussed in the following subsections.

Viewing Fibre Channel Link Information

To see link statistics for the Fibre Channel port:

- **1) In the Fibre Channel Status Menu, choose Display Fibre Channel Link Status.**

The following page is displayed.

See [Table 9](#) for a list of term definitions.

```

Fibre Channel Status & Statistics
X.XX.XX XXXXXX XXXXXX-XXX-XXXXXXXXXXXXXXXXX
01/06/2003 09:00:43

Current Fibre Channel Status - Port 0

LinkState      UP/LOOP      ALPA          x00000001    InDevDataSeqs x00000000
OutDevDataSeq  x00000000    InLnkDataSeqs x00000005    OutLnkDataSeq  x00000084
InP_BSYFrames  x00000000    OutP_BSYFrms  x00000000    InF_BSYFrames  x00000000
InP_RJTFrames  x00000000    OutP_RJTFrame x00000000    LinkDowns      x00000002
InABTSS        x00000000    OutABTSS      x00000000    LaserFaults    x00000000
SignalLosses   x00000000    SyncLosses    x00000000    BadRxChars     x00000000
LinkFailures   x00000001    BadCRCFrames  x00000000    ProtocolErrs   x00000000
BadSCSIframes  x00000000

A) Autorepeat
X) Return to previous menu

Command >

```

Figure 70: Fibre Channel Link Status screen

- **A) To refresh the screen display, select Autorepeat.**

Table 9: Link Status Definitions

Link Status Field	Definition
LinkState	Current Fibre Channel link status.
AL_PA	Arbitrated loop physical address. (not supported)
InDevDataSeqs	Number of Device Data sequences received by this port.
OutDevDataSeq	Number of Device Data sequences transmitted by this port.
InLnkDataSeqs	Number of Link Data frames received by this port.
InP_BSYFrames	Number of P_BSY frames received by this port.
OutP_BSYFrms	Number of P_BSY frames transmitted by this port.
InF_BSYFrames	Number of F_BSY frames received by this port.
InP_RJTFrames	Number of P_RJT frames received by this port.
OutP_RJTFrame	Number of P_RJT frames transmitted by this port.
LinkDowns	Number of Link Down conditions detected.
InABTSs	Number of ABTS frames received.
OutABTSs	Number of ABTS frames transmitted.
LaserFaults	Number of laser faults detected.
SignalLosses	Number of times Loss of Signal was detected.
SyncLosses	Number of times Loss of Sync was detected.
BadRxChars	Number of bad characters received.
LinkFailures	Number of Link Failure conditions.
BadCRCFrames	Number of frames received with a bad CRC.
ProtocolErrs	Number of protocol errors detected.
BadSCSIFrames	Number of BAD SCSI frames detected.

Viewing Attached Fibre Channel Devices

To view a list of the devices attached to this port:

1. In the Fibre Channel Status Menu, choose **2) Display Attached Fibre Channel Devices**.

The Fibre Channel Device Display page is displayed.

[Figure 71](#) is an illustration of the Fibre Channel Device Display page when it is first displayed.

```

Fibre Channel Device Display
X.XX.XX XXXXXX XXXXXX-XXX_XXXXXXXXXXXXXXXXX
01/06/2003 09:00:46

FC Port: 0 Port id: 0x000001

R) Refresh Device Display
D) Display Device Details
X) Return to previous menu

Command, <enter> for next FC Port > r
Port 0: Requesting discovery
Doing device discovery on port 0...
Completed discovery on port 0

Fibre Channel Device Display
Version X.X XXXX

FC Port: 0 Port id: 0x000001

Port 0: TARGET DEVICE (UP) Port id: 0x000010
SEAGATE ST39103FC Revision: 0003 ANSI SCSI Revision: 02 Type: Direct Access

R) Refresh Device Display
D) Display Device Details
X) Return to previous menu

```

Figure 71: Fibre Channel Device Display page

2. To refresh the display, select **R) Refresh Device Display**.

Note: In Router-to-Router (R2R) configurations, only the first device of all the attached devices will be shown. To see all of the devices in R2R configurations, use Visual Manage.

3. To view device details, select **D) Display Device Details**.

Viewing Fibre Channel Resource Transport Information

To view FCP transport information, in the Fibre Channel Status Menu, choose **3) Display Fibre Channel Resource Status**.

The FCP Transport Queues page is displayed.

The FCP Transport Queue page has no options. It is used only for viewing resource status.

[Figure 72](#) is an illustration of the FCP Transport Queue page.

```

FCP Transport Queues:
 fcpRcvEventQ  fcpCmpltEventQ  fcpSendReqQ  fcpCmdInProgressQ
      0              0              0              1

 fcpRcvRmiQ  fcpRmiXmitPendQ  free_fcp_req_q  free_fcp_cmd_q
      0              0              1023            511

 fcpFreeFcpIuBufsQ  fcpFreeQelmtsQ  fcpFreeSpoofControlQ
      2047              1              499

(Press any key to continue)

```

Figure 72: FCP Transport Queues screen

Viewing Fibre Channel Driver Status Information

To display Fibre Channel Driver Queue information, in the Fibre Channel Status Menu, select **4) Display Fibre Channel Driver Resource Status**.

The Fibre Channel Driver Queues page is displayed.

The Fibre Channel Driver Queues page has no options. It is used only for viewing Fibre Channel driver resources.

```

Port 0 FC Driver Queues:
 SFSBufsQ  TachHdrQ  ESGQ  QElemFreeList
      1024      1064      2048      537

 ERQWaitQ  SCSIWaitQ
      0      0

Port 0 FC-2 Layer Queues:
 FreeTxSbufQ  FreeIOCBQ  FreeLDBQ  FreeEDBQ
      256      1023      508      767

(Press any key to continue)

```

Figure 73: Fibre Channel Driver Queues screen

Viewing SCSI Status Information

To display SCSI status information, in the System Statistics Menu, choose **3) Display Parallel SCSI Protocol Status**.

The Parallel SCSI Protocol Status Menu is displayed.

[Figure 74](#) is an illustration of the SCSI Status Menu.

```
Parallel Scsi Protocol Status Menu
X.XX.XX XXXXXX XXXXXX-XXX_XXXXXXXXXXXXXXXXX
01/06/2003 09:01:46

1) Display SCSI Statistics
2) Display Attached SCSI Devices
3) Display SCSI Resource Status

X) Return to previous menu
```

Figure 74: SCSI Status menu

SCSI Status Menu options:

- **1) Display SCSI Statistics** displays SCSI statistics.
- **2) Display Attached SCSI Devices** displays attached SCSI devices.
- **3) Display SCSI Resource Status** displays SCSI resource status.

Each option is discussed in the following paragraphs.

Viewing SCSI Statistics

To view the SCSI status page, in the SCSI Status Menu, choose **1) Display SCSI Statistics**. There are no options in this display screen.

Viewing Attached SCSI Devices

To see a list of the devices attached to this SCSI bus in the SCSI Status Menu, choose **2) Display Attached SCSI Devices**.

The SCSI Device Display Menu is displayed.

Figure 75 is an illustration of the SCSI Device Display Menu.

```
SCSI Device Display Menu
X.XX.XX XXXXXX XXXXXX-XXX_XXXXXXXXXXXXXXXXX
01/06/2003 09:01:56

1) Issue discovery for all buses
2) Issue discovery for selected bus
3) Issue boot discovery(includes resets and delays)
4) Display all local devices
5) Display local devices on specified bus

X) Return to previous menu
```

Figure 75: SCSI Device Display menu

SCSI Device Display Menu options:

- **1) Issue discovery for all buses** issues a discovery command for *all* SCSI buses.
- **2) Issue discovery for selected bus** issues a discovery command for *the selected* bus.
- **3) Issue boot discovery** issues a boot discovery command.
- **4) Display all local devices** displays a list of local devices for *all* buses.
- **5) Display local devices on specified bus** displays a list of local devices for *the selected* bus.

Viewing SCSI Resource Information

To display SCSI resource information, in the SCSI Status Menu, choose **3) Display SCSI Resource Status**.

The SCSI Resource Display page is displayed. There are no options in the SCSI Resource Display. It is used only for viewing SCSI resource status.

Figure 76 is an illustration of the SCSI Resource Display page.

```

          SCSI Resource Display
    X.XX.XX XXXXXX XXXXXX-XXX_XXXXXXXXXXXXXXXXXX
          01/06/2003 09:02:06

psNotifyFreeQ  psPendingFreeQ  psTaskFreeQ  psCmdFreeQ
      16             2048             2045             0

psActiveInitiatorFreeQ  psLocalHostFreeQ  psLocalDeviceFreeQ
      1023                   16                   255

pEventQ  pEventQfree  psDoubleQelmtFreeQ
      0           1024           4096

(Please hit any key to continue)

```

Figure 76: SCSI Resource Display screen

Event Log

In the System Utilities Menu, **2) Event Log** is used to view and clear the system Event Log.

Figure 77 is an illustration of the Event Log Menu.

```

          Event Log Menu
    X.XX.XX XXXXXX XXXXXX-XXX_XXXXXXXXXXXXXXXXXX
          01/06/2003 09:02:16

1) Display event log
2) Clear event log

X) Return to previous menu

```

Figure 77: Event Log menu

Event Log Menu options:

- **1) Display event log** displays the Event Log.
- **2) Clear event log** deletes all entries from the Event Log.

Trace Dump Menu

In the router Main Menu, **3) Display Trace and Assertion History** is used to manage trace history information.

[Figure 78](#) is an illustration of the Trace Dump Menu.

```
Trace Dump Menu
X.XX.XX XXXXXX XXXXXX-XXX_XXXXXXXXXXXXXXXXXX
01/06/2003 09:02:26

1) Display trace for current boot cycle
2) Display trace from previous boot cycle
3) Display trace from last assertion failure
4) Clear current trace buffer
5) Clear (flash) assert trace buffer

X) Return to previous menu
```

Figure 78: Trace Dump menu

Trace Dump Menu options:

- **1) Display trace for current boot cycle** displays current boot cycle trace history information.
- **2) Display trace from previous boot cycle** displays previous boot cycle trace history information.
- **3) Display trace from the last assertion failure** displays trace history information from the last assertion failure.
- **4) Clear current trace buffer** clears the current trace buffer.
- **5) Clear (flash) assert trace buffer** clears the assertion failure trace buffer.
- X) Return to previous menu

Saving Copies of the Trace Buffers using FTP

Using an FTP session, the trace buffers from the router can be copied and saved.

1. Verify the router is connected to the Ethernet network.
2. Start an FTP session.
3. Enter the router IP address at the FTP prompt:

```
ftp <IP address>
```

Note: Initially, the factory default router IP address is 1.1.1.1. To view the current IP address, navigate to the Ethernet Configuration Menu and view the screen display. See the “Configuration Menu” section for information on viewing and changing the router IP address.

4. Specify the directory location on the computer or network where the FTP program will store the trace file.
5. Enter the user name and password.
The factory default user name is `root` and the default password is `password`.
6. Specify Bin mode:

```
bin
```
7. Enter the appropriate command to copy the current or previous trace buffer:
 - To copy the current trace buffer:

```
get curtrace.txt
```
 - The file will transfer from the router.
 - To copy the previous trace buffer:

```
get prvtrace.txt
```
 - The file will transfer from the router.

Reboot Option

To reboot the router, in the Main Menu, select **4) Reboot**.

After this option is selected, a confirmation prompt is displayed. If a positive response is given to the confirmation message, the router is restarted.

Note: Current router activities will be disrupted during a reboot.

Download New Firmware Option

To download a new version of the firmware:

1. Select **5) Download a New Revision of the Firmware** in the router Main Menu.
A confirmation prompt is displayed.
2. Respond to the confirmation prompt.
3. Select **Transfer, Send File** in the terminal emulator utility.
4. Select the location of the firmware.
If necessary, use **Browse** to search for the file.
5. Select XMODEM as the transfer protocol.
6. Press the **Send** button.

The firmware will begin downloading to the router.

When the download process is complete, the system verifies that the firmware image was successfully written to the FLASH memory and reboots. When the router is rebooted, it detects that there is a newly downloaded firmware image, copies that image to the boot sector of the FLASH, and boots using the new image.

Figure 79 is an illustration of the Download Firmware Menu after a new version of the firmware has been loaded.

```
Download Firmware Menu
X.XX.XX XXXXXX XXXXXX-XXX_XXXXXXXXXXXXXXXXX
01/06/2003 09:02:29

This will replace the current revision of the firmware.
A reboot will also be performed as part of this process.

Are you sure (y/n)? y

Please begin xmodem file transfer...
$$$$$$$$

D O W N L O A D   C O M P L E T E

*****

...* Start System Cold Reboot!!
```

Figure 79: Download Firmware menu

FTP User Interface



5

The following tasks can be managed through an FTP interface:

- [Access the FTP User Interface \(UI\)](#), page 146
- [Backup and Restore Configuration Settings](#), page 146
- [Copy Trace Buffers](#), page 149
- [Upgrade Firmware](#), page 150

Each of these procedures is discussed in this chapter.

Access the FTP User Interface (UI)

To access the router using an FTP UI:

1. Connect the router to the Ethernet network used by the host computer.
2. Start an FTP session using the router IP address:

```
ftp <IP address>
```

where *IP address* is the IP address of the router.

The default router IP address is 1 . 1 . 1 . 1.

Note: You may also need to specify the external directory location where your FTP utility will store the backup configuration file.

3. Enter the user name and password.

The default user name is `root` and the default password is `password`.

Backup and Restore Configuration Settings

The router supports the backup and restore of configuration settings over FTP. This allows multiple configuration files to be maintained in a location external to the router. When backing up a configuration, the settings are saved from the flash memory on the router to a binary file in an external location determined by the user.

Backing up the Router Configuration

To backup the router configuration settings:

1. Connect the router to the Ethernet network used by the host computer.
2. Start an FTP session using the router IP address:

```
ftp <IP address>
```

where *IP address* is the IP address of the router.

The default router IP address is 1 . 1 . 1 . 1.

Note: You will need to specify the external directory location where your FTP utility is to store the backup configuration file.

3. Enter the user name and password.

The default user name is `root` and the default password is `password`.

HP recommends that the user name and password be changed from the default values.

4. Specify binary mode:

```
bin
```

5. Specify the filename (with the extension `.cfg`) using the `get` command:

```
get filename.cfg
```

The file will transfer to the user-specified location.

Note: When backing up a configuration file, the World Wide Name (WWN) values and Ethernet physical address (MAC address) values are not saved in the configuration file. All other configuration settings are saved.

Restoring the Router Configuration

To restore a configuration to the router:

1. Connect the router to the Ethernet network used by the host computer.
2. Start an FTP session using the router IP address:

```
ftp <IP address>
```

where *IP address* is the address of the router.

The default IP address of the router is 1 . 1 . 1 . 1.

3. Enter the user name and password.

The default user name is `root` and the default password is `password`.

HP recommends that the user name and password be changed from the default values.

4. Specify binary mode:

```
bin
```

5. Specify the configuration's path and filename (with the filename extension `.cfg`) using the `put` command:

```
put <path:filename.cfg>
```

The file is transferred to the router. After the file transfer is complete, the router will automatically reboot. When the router completes the POST process, it will use the restored configuration.

Note: When restoring a configuration, World Wide Name (WWN) values and Ethernet physical address (MAC address) values revert to the factory default settings. User defined values for these settings are not retained and must be re-entered after the restoration of the configuration is complete.

Confirm the restored configuration by verifying that the settings are correct.

Copy Trace Buffers

Use the following procedure to save copies of the trace buffers:

1. Connect the router to the Ethernet network used by the host computer.
2. Start an FTP session using the router IP address:

```
ftp <IP address>
```

where *IP address* is the address of the router.

The default router IP address is 1 . 1 . 1 . 1.

Note: You will need to specify the directory location where your FTP utility will store the trace file.

3. Enter the user name and password.

The default user name is `root` and the default password is `password`.

HP recommends that the user name and password be changed from the default values.

4. Specify binary mode:

```
bin
```

5. Specify the filename (with the extension `.txt`) using the `get` command.

For the *current trace buffer*, use the following command:

```
get curtrace.txt
```

For the *previous trace buffer*, use the following command:

```
get prvtrace.txt
```

Upgrade Firmware

Use the following procedure for Windows-based systems to upgrade the router firmware.

Note: A JAVA applet-based FTP utility is also accessible from the UI.

1. Connect the router to the Ethernet network used by the host computer.
2. Start an FTP session using the router IP address:

```
ftp <IP address>
```

where *IP address* is the IP address of the router.

The default router IP address is 1 . 1 . 1 . 1.

3. Enter the user name and password.

The default user name is `root` and the default password is `password`.

HP recommends that the user name and password be changed from the default values.

4. Specify binary mode:

```
bin
```

5. Specify the path and filename (extension.dlx) of the firmware file to be transferred by using the `put` command as shown:

```
put <path:filename.dlx>
```

The firmware file will be transferred and the router automatically reboots. The firmware upgrade will be effective after POST process completes.

Note: Confirm the firmware level by checking the reboot messages through the serial interface.

Basic Troubleshooting

6

This chapter discusses some basic methods of identifying problems in the setup and configuration of the HP StorageWorks Network Storage Router.

Most problems occur during the initial installation of the router. Before proceeding with advanced troubleshooting techniques, verify all connections and review the configuration.

The following topics are discussed in this chapter:

- [LED Indicators](#), page 153
- [Basic Troubleshooting](#), page 155
 - Verifying SCSI bus configuration
 - Verifying Fibre Channel Port Connection
 - Verifying SCSI devices in Windows NT
 - Verifying the router configuration
 - Verifying mapping
 - Verifying devices
 - Verifying host configuration
 - Verifying HBA device driver information
 - Verifying serial port configuration
 - Verifying PRLI data

- [Introducing HP StorageWorks Library and Tape Tools](#), page 160
 - Software Features
 - Finding Additional Information
 - Getting Support

LED Indicators

The LED indicators on the router are useful for diagnosing various problems:

- The *Fibre Channel port* LEDs indicates Fibre Channel activity and link status. If one of these indicators does not light or stays continually lit without any corresponding SCSI bus activity, it may indicate a problem with the Fibre Channel link. Verify the Fibre Channel configuration.
- The *SCSI bus* LEDs indicates SCSI activity. These indicators are lit during power up, configuration, and when the unit is transferring data. If the SCSI indicator stays continually lit without any corresponding Fibre Channel LED activity, it may indicate a problem with the SCSI bus configuration. Verify the SCSI bus configuration.
- The *Ethernet* LEDs indicates activity and link status. If one of these indicators does not light or stays continuously lit, it may indicate a problem with the network connection. Verify the network connection. The port must be connected to a 10/100BaseT Ethernet network to function properly.

Additional information on the specific LEDs is available in Chapter 1, "[External Features Overview](#)."

For an illustration of the router components and LED locations, see [Figure 80](#).

Figure 80: Router illustration

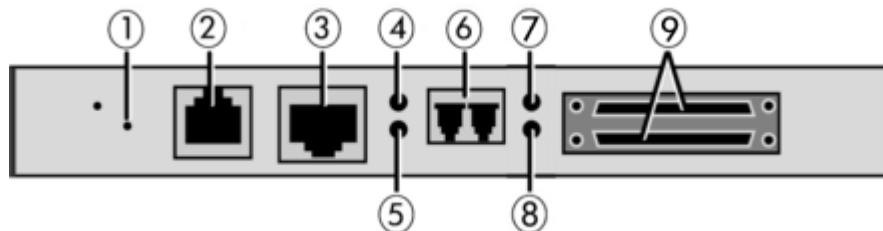

Table 10: Router illustration components

Item	Description
①	Power LED
②	Serial RJ-11 connector
③	Ethernet RJ-45 connector
④	Fibre Channel activity LED
⑤	Fibre Channel link LED
⑥	Fibre Channel Port

Table 10: Router illustration components

Item	Description
7	SCSI bus activity LED (on corresponding port)
8	SCSI bus activity LED (on corresponding port)
9	SCSI VHDCI connector (2)

Basic Troubleshooting

If possible, simplify the installation by reducing it to the most basic configuration. Then, add elements one at a time, verifying the operation after each step.

Basic troubleshooting includes verifying the setup and the connections, including:

- Verifying SCSI bus configuration
- Verifying Fibre Channel port connection
- Verifying SCSI devices in Windows NT
- Verifying the router configuration
- Verifying mapping
- Verifying devices
- Verifying host configuration
- Verifying HBS device driver information
- Verifying serial port configuration
- Verifying PRLI data

Each of these topics is discussed in the following sections.

Verifying SCSI Bus Configuration

Items to check include:

- **Termination** — Problems with termination can cause intermittent or hard failures. A SCSI bus must be terminated on both ends. Termination problems are common when both narrow and wide devices are on the same bus.
- **Bus Type** — On an LVD SCSI bus, SE and LVD devices can be connected to the same bus. However, if one SE device is detected during power up, communication to all devices will convert to SE mode.
- **Device ID** — Each device on a SCSI bus must have a unique ID. Verify configured IDs are not in use by other devices on the same SCSI bus.
- **Cabling** — Check SCSI cables to verify they are functional. SCSI rules for total length, distance between devices, and stub length must be followed. Connections should also be checked and reseated if necessary.
- **SCSI Devices** — Verify that the SCSI devices on a particular SCSI bus can be seen in the Configuration Menu of the router. If the router cannot see the devices, verify SCSI configuration, cabling, and termination.

Verifying Fibre Channel Port Connection

If SCSI devices are recognized on the SCSI buses, but do not appear to the Fibre Channel host, it may be that the Fibre Channel link is not properly established. Most hubs and switches have link indicators showing link status. When the router is connected and powered on, this link indicator should be solid. If it is not, check the cabling or connections.

One method of verifying link integrity when connected to a functional host, involves disconnecting and then reconnecting the Fibre Channel cable. This procedure should cause momentary activity of this indicator as the link reinitializes.

Additionally, verify that the cable type of the router and the attached hub, HBA, or switch is of corresponding types. When using optical media, verify that the attached device is using non-OFC type optical devices.

Note: By default, the Fibre Channel port speed is set to 2 Gb/s. Changes to the Fibre Channel port speed must be manually set, such as for 1 Gb/s. If set incorrectly and the router is plugged into a Loop or Fabric, the unit may receive framing errors, which can be found in the trace logs, and the fiber link light will be off because of the incorrect Fibre Channel link speed. For more information on manually setting the Fibre Channel port speed, see Chapter 3, "[Fibre Channel Port Configuration](#)."

Verifying SCSI Devices in Windows NT

If running Fibre Channel-to-SCSI mapping mode, verify the Fibre Channel and the SCSI devices are recognized by the router.

Sometimes Windows NT may need to be rebooted with all SCSI devices and the router powered up before recognizing the devices.

To verify the Fibre Channel and SCSI devices:

1. Navigate to the Windows NT Control Panel, and select SCSI Adapters.
2. Double click the Fibre Channel HBA.

The SCSI devices should be listed.

If no devices are listed, verify the router configuration, Fibre Channel HBA configuration, and cabling.

If devices are listed, verify the Fibre Channel HBA mapping mode or the AL_PA addresses.

Verifying the Router Configuration

If you are in doubt about the configuration or about the location of the error, restore the router to the factory default configuration and proceed to configure the unit one step at a time, verifying the functionality of the configuration after each change is made.



Caution: Restoring factory defaults overwrites user configurations. In the Serial/Telnet interface, use the save configuration option before resetting factory defaults to allow recovery of user configuration.

Verifying Mapping

If the router is working in Fibre Channel-to-SCSI Initiator mode and is using Indexed or SCC mapping, try changing to Auto-assigned mapping.

Verifying Devices

It may be useful to connect the SCSI target devices directly to a SCSI interface (for example, a host SCSI bus) to verify that the devices are functional.

Verifying the Host Configuration

In some cases, the Fibre Channel HBA or host device driver may not be working properly. Check the configuration of these elements.

It may be useful to check the release notes for the device driver to see if there are any specific issues or a required configuration. It may also be useful to ensure that the current version of the HBA driver is being used.

There are cases where older applications can have expectations about what constitutes a valid SCSI ID, and thus may not correctly handle certain mappings. This is not an issue for the operating system or most applications. However, some applications may exhibit difficulties addressing target IDs greater than 15 (16 and higher.) To resolve this situation, configure the router to use hard addressing and set the AL_PA to a value that the HBA will be able to map with an ID less than 16.

Verifying HBA Device Driver Information

Review the HBA device driver *Readme.txt* file for configuration specifics. An HBA may require a different configuration. HBAs typically come with utility programs to view or change their configurations.

Verifying Serial Port Configuration

If you are having problems connecting via the serial interface, verify the configuration of the terminal or terminal emulation program.

Table 11: Terminal Configuration Settings

BAUD Rate	Autobaud, 9600, 19200, 38400, 57600, 115200
Data Bits	8
Stop Bit	1
Parity	None
Flow Control	XON/XOFF

If problems persist, verify the cabling.

If a valid Ethernet IP address is configured, serial configuration settings can also be set via Telnet.

Verifying PRLI Data

The router returns the PRLI (preliminary login) response data as specified in [Table 12](#).

In the default configuration, the router returns PRLI Data (PRLI Accept Payload) with the Target bit SET and the Initiator bit CLEAR. However, some configurations require the Initiator bit be SET, such as in router-to-router configurations. See the Fibre Channel Overrides Menu for more information about changing the initiator bit.

Table 12: PRLI

Item	Value
PRLI Command Code	0x20
Page Length	0x10
Payload Length	0x10
Type Code	0x8
Type Code Extension	0x0
OPA	0x0
RPA	0x0
IPE	0x1
Response Code	0x1
Originator Process Associator	0x0
Responder Process Associator	0x0
Initiator Function	0x1
Target Function	0x1
Command/Data Mixed Allowed	0x0
Data/Response Mixed Allowed	0x0
Read XFER_RDY Disabled	0x1
Write XFER_RDY Disabled	0x0

Introducing HP StorageWorks Library and Tape Tools

To provide continued service to our customers, HP provides the HP StorageWorks Library and Tape Tools (L&TT) software application. L&TT is a diagnostic tool that is designed to aid in the installation and maintenance of both HP tape devices and tape libraries. L&TT includes several features designed for use by both HP storage customers and trained service personnel. The key features include:

- Diagnostic tools for tape drive and tape automation devices designed for simple troubleshooting.
- Multiple options for retrieving and updating both the latest firmware and the most current version of L&TT.

Frequent firmware image updates are released on the Internet. For optimal performance, HP recommends that you update your system periodically with the latest device firmware.

L&TT is available for download at no cost from the HP website at:

www.hp.com/support/tapetools

Software Features

L&TT offers the following features:

- **Installation Check**-L&TT guides the user through a basic installation check of your product. The software assists the user in choosing an appropriate HBA and SCSI ID(s), ensuring that the device is detected by the system, and verifying key device functionality. This feature is essentially HTML documentation that helps with the most common generic installation issues while also describing how to use L&TT to verify the device installation.
- **Device Identification**-L&TT clearly identifies the storage products connected to the system, along with key information on product configuration and status.
- **Troubleshooting Tests**-L&TT provides various tests to verify product functionality or to isolate product issues. Tests include device self-tests, read/write tests on drives, exerciser tests for autoloaders and libraries, and specific device utilities.

- **Firmware Upgrades**-L&TT provides a convenient way of updating product firmware, enabling users with an Internet connection to take advantage of ongoing enhancements. The software can be configured to check the Web automatically for firmware updates for connected devices, or you can manually check the Web for updates if the automatic update feature is not desired. If updated firmware is available, the program notifies the user, and the updates can easily be copied to the system. With libraries, users can upgrade the library and the embedded drive firmware in the same operation. Wherever possible, the embedded drives are updated in parallel to reduce time.
- **Support Ticket Generation**-If users experience a problem with a storage product, L&TT can generate a support ticket that includes essential information for troubleshooting the problem. As an alternative to phone support, users can E-mail the support ticket to a support center for assistance. This information streamlines the support process and enables the support staff to better serve the user if a support call is made later.
- **Device Analysis**-When you generate a support ticket for a device, L&TT performs a Device Analysis test on the device. The support ticket contains generic information about a device, as well as the results of the Device Analysis test. You can perform the Device Analysis test by itself, but HP recommends generating a support ticket because the resulting data is presented in a more useful format.
- **Automatic Notification of Web Updates**-If you have an Internet connection and web updates are enabled in the tool preferences, you are automatically informed of the following updates, if available, each time the program is started:
 - New versions of L&TT
 - New firmware files for connected devices
 - New device-specific functionality (such as new or updated tests) for connected devices

Finding Additional Information

The HP website provides the current version of L&TT for download, and general information about the tool. Access the website at:

<http://www.hp.com/support/tapetools>

Getting Support

E-mail support is available from lt_team@hp.com. You should expect a response within 24 hours (usually sooner) during a normal business week.

Use this address to obtain support for L&TT, to report bugs, to report any issues with the L&TT Website, or to provide enhancement suggestions. HP appreciates feedback on how to make improvements for future versions of L&TT.

Note: This address is intended to provide support for L&TT software. This address is NOT for assistance in troubleshooting hardware products. Refer to the documentation that comes with your hardware for support options for that product.

Serial and Ethernet Pin Assignments



This appendix provides details for:

- [RJ-11 Serial Pin Assignments](#), page 164
- [RJ-45 Ethernet Cable Pin Assignments](#), page 165

RJ-11 Serial Pin Assignments

The layout of the pin assignments for the serial receptacle on the router is illustrated in [Figure 81](#).

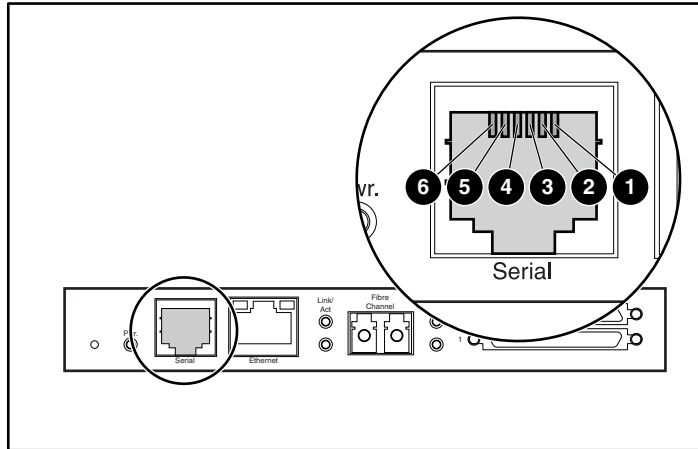

Figure 81: RJ-11 Serial pin assignments

The pin definitions listed in [Table 13](#) correspond to the pin assignments in [Figure 81](#).

Table 13: RJ-11 Serial Pin Assignments

Item	Description
①	No connection
②	Serial common (ground)
③	Transmit data
④	Receive data
⑤	CTS (clear to send)
⑥	RTS (request to send)

Note: To connect the router to a host system, use a RS-232 null modem cable.

RJ-45 Ethernet Cable Pin Assignments

The layout of the pin assignments for RJ-45 Ethernet receptacle is illustrated in [Figure 82](#).

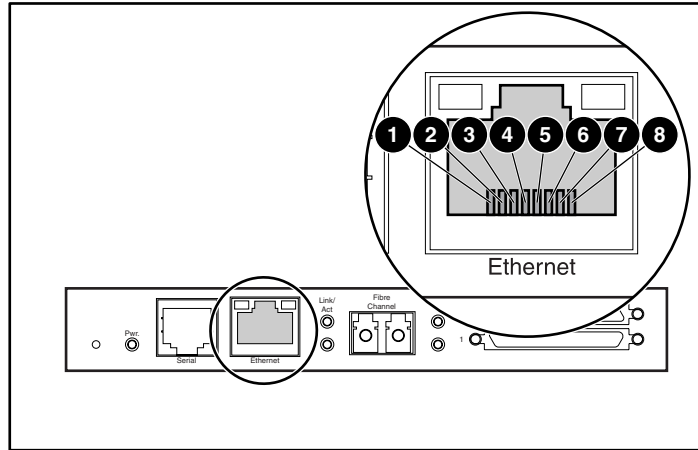

Figure 82: RJ-45 Ethernet pin assignments

The pin definitions listed in [Table 14](#) correspond to the pins assignments in [Figure 82](#).

The router Ethernet connection supports the IEEE specifications for 10BASE-T and 100BASE-TX Ethernet standards.

Table 14: RJ-45 Ethernet Pin Assignments

Item	Description
①	Transmit Out +
②	Transmit Out -
③	Receive in +
④	No Connection
⑤	No Connection
⑥	Receive in -
⑦	No Connection
⑧	No Connection

Controller LUN Commands



B

The HP StorageWorks Network Storage Router supports and executes the set of SCSI-3 commands listed in this Appendix. These commands can be received as FCP commands over the Fibre Channel bus and are supported by the Controller LUNs. This document refers to these commands as Controller LUN commands. Complete definitions of SCSI-3 commands can be found in the SCSI-3 standard available from the American National Standards Institute (ANSI).

This Appendix explains general Controller LUN commands.

To first determine which router LUNs are controller LUNs and which are device LUNs, the host software must use the Inquiry general command.

Controller LUNs are addressable in all addressing modes. In SCC mode, there is one controller LUN. In Auto-Assigned and Indexed modes, there can be up to four configurable controller LUNs.

Note: Controller LUNs are numbered in sequence following the last device LUN, without any gaps. A controller LUN may be placed anywhere in custom tables.

General Commands

- Report LUNs
- Inquiry

Each of these commands is discussed in the following paragraphs.

Report LUNs Command

The Report LUNs command returns a list of LUNs that can receive commands. The format of the Report LUNs command is shown in [Table 15](#).

Table 15: Format of Report LUNs Command

Bit/ Byte	7	6	5	4	3	2	1	0
0	Operation Code (Example: 0xA0)							
1	Reserved							
2	Reserved							
3	Reserved							
4	Reserved							
5	Reserved							
6	Most Significant Byte (MSB)							
7	Allocation Length							
8								
9	Least Significant Byte (LSB)							
10	Reserved							
11	Control Byte							

The router returns the LUN Parameters as defined in [Table 16](#).

Table 16: Report LUNs Data

Bit/ Byte	7	6	5	4	3	2	1	0
0	Most Significant Byte (MSB)							
1	LUNs Length List							
2								
3	Least Significant Byte (LSB)							
4	Reserved							
5	Reserved							
6	Reserved							
7	Reserved							

All LUNs are reported and will appear in the host map.

Note: In addition to the device LUNs, controller LUNs are also included in the report. Controller LUN values are displayed at the end of the list. Controller LUN Inquiries report peripheral device types as 0x0c.

Inquiry Command

The format of the Inquiry Command is shown in [Table 17](#).

Table 17: Format of LUN Inquiry Command

Bit/ Byte	7	6	5	4	3	2	1	0
0	Operation Code (Example: 0x12)							
1	Reserved							EVPD
2	Page Code or Operation Code							
3	Reserved							
4	Allocation Length							
5	Control							

EVPD Page 0x80

If the EVPD bit (bit 0 of byte 1) is set and the Page Code is 0x80, the *unit serial number page* is returned. The format of this page is shown in [Figure 18](#).

Table 18: Format of EVPD Page 0X80

Bit/ Byte	7	6	5	4	3	2	1	0
0	Device Type (Example: 0x0c)							
1	Page Code (80h)							
3	Reserved							
4	Page Length							
5	Serial Number							

The router returns the LUN Inquiry Data as defined in [Table 19](#)

Table 19: LUN Inquiry Data

Item	Value
Peripheral Qualifier	0x00
Peripheral Device Type	0x0C – Indicates Router/Router function
RMB	0x00
Device Type Qualifier	0x00
ISO Version	0x00
AENC	0x00
TrmIOP	0x00
Response Data Format	0x02 – SCSI-2 Inquiry Data Format
Additional Length	0x20
RelAdr	0x00
Wbus32	0x00
Sync	0x00
Linked	0x00
CmdQue	0x00
SftRe	0x00

Table 19: LUN Inquiry Data

Item	Value
Vendor ID	"HP"
Product ID	"router"
Revision Level	"XXXXXX"

The router will only reply to a SCSI Inquiry using 8-byte LUN field of 0x00.

Note: The Revision Level comes from the last four characters of the build string, which appears in the headings for most menu screens.

Addressing Methods and Table Structures



Fibre Channel and SCSI systems use different methods of addressing devices. The router has a method of translating device IDs so each SCSI device is mapped to the appropriate Fibre Channel LUN. The SCSI buses establish the bus connections between devices. Targets on a SCSI bus may internally address LUNs. The addressing of a specific SCSI device is represented by the BUS:TARGET:LUN triplet.

When a Fibre Channel Initiator initializes on a loop, the host must first determine what devices exist on the loop. Device discovery is performed and an FCP target device list is built. Each device is queried for FCP LUNs (the LUNs are the actual devices that the operating system will address.) The addressing used is the SCC Logical Unit Addressing and Peripheral Device Addressing method, shown in [Table 20](#) through [Table 23](#). First level addressing is supported, so only the first two bits of the 8-bit FCP LUN are used.

Table 20: Addressing Sequence

Bit/Byte	7	6	5	4	3	2	1	0
N	Address Method				Address Method Specific			
N+1	Address Method Specific							

Table 21: Address Method Definitions

Code	Description
00	Peripheral Device Addressing Method
01	Volume Set Addressing Method
10	Logical Unit Addressing Method
11	Reserved

Table 22: SCSI Logical Unit Addressing

Bit/Byte	7	6	5	4	3	2	1	0
N	1	0	Target					

Table 23: Peripheral Device Addressing

Bit/Byte	7	6	5	4	3	2	1	0
N	0	0	Bus					
N+1	Target/LUN							

Depending on the configuration, the router supports the Peripheral Device Addressing method and the Logical Unit Addressing method.

The data shown in [Table 24](#) comes from the Fibre Channel Configuration Menu. The administrator enters the node number (number to the left of the colon in [Table 24](#)) and the router translates the node number into the corresponding AL_PA value (number to the right of the colon in [Table 24](#)).

Table 24: Arbitrated Loop Node-Number to AL-PA Lookup Table

0:0x01	21:0x2E	42:0x52	63:0x74	84:0xA6	105:0xC9
1:0x02	22:0x31	43:0x53	64:0x75	85:0xA7	106:0xCA
2:0x04	23:0x32	44:0x54	65:0x76	86:0xA9	107:0xCB
3:0x08	24:0x33	45:0x55	66:0x79	87:0xAA	108:0xCC
4:0x0F	25:0x34	46:0x56	67:0x7A	88:0xAB	109:0xCD
5:0x10	26:0x35	47:0x59	68:0x7C	89:0xAC	110:0xCE
6:0x17	27:0x36	48:0x5A	69:0x80	90:0xAD	111:0xD1
7:0x18	28:0x39	49:0x5C	70:0x81	91:0xAE	112:0xD2
8:0x1B	29:0x3A	50:0x63	71:0x82	92:0xB1	113:0xD3
9:0x1D	30:0x3C	51:0x65	72:0x84	93:0xB2	114:0xD4
10:0x1E	31:0x43	52:0x66	73:0x88	94:0xB3	115:0xD5
11:0x1F	32:0x45	53:0x67	74:0x8F	95:0xB4	116:0xD6
12:0x23	33:0x46	54:0x69	75:0x90	96:0xB5	117:0xD9
13:0x25	34:0x47	55:0x6A	76:0x97	97:0xB6	118:0xDA
14:0x26	35:0x49	56:0x6B	77:0x98	98:0xB9	119:0xDC
15:0x27	36:0x4A	57:0x6C	78:0x9B	99:0xBA	120:0xE0
16:0x29	37:0x4B	58:0x6D	79:0x9D	100:0xBC	121:0xE1
17:0x2A	38:0x4C	59:0x6E	80:0x9E	101:0xC3	122:0xE2
18:0x2B	39:0x4D	60:0x71	81:0x9F	102:0xC5	123:0xE4
19:0x2C	40:0x4E	61:0x72	82:0xA3	103:0xC6	124:0xE8
20:0x2D	41:0x51	62:0x73	83:0xA5	104:0xC7	125:0xEF

SCC (SCSI Controller Command) Addressing Method

When a router is configured to use SCSI Controller Command addressing (SCC) and a command is received, the router either will respond as a controller device to the FCP Initiator or will route the FCP request to a specified BUS:TARGET:LUN. If a request using the Peripheral Device Addressing method is received (an FCP command with the LUN field bits 7 and 6 of byte 0 set to 0), the router routes the request to the internal processor, which acts on the command directly. If a request using the Logical Unit Addressing method is received (bits 7 and 6 set to 00x10), the request is routed to the BUS:TARGET:LUN as specified in the defined field

Host systems using SCC addressing will typically do initial device discovery using the Peripheral Device Addressing method. On issuing an Inquiry command to the router, the host will receive the router Inquiry data, indicating the device type as a controller device (Inquiry data indicates device type is 0xC). The host will then know that subsequent commands to router-attached devices will use the Logical Unit Addressing method.

The host can perform discovery by either progressing through the BUS:TARGET:LUN values, as would a standard SCSI driver, or by issuing a Report LUNs command. This command is sent to the router (using the Peripheral Device Addressing method). The router returns a table indicating the attached devices. The host can then perform actions on these devices directly without performing further discovery processing.

Auto Assigned Addressing Method

The Auto Assigned addressing method is created through SCSI device discovery on power up or reset. As the router performs device discovery on the SCSI bus, the index table FCP LUN values are filled with adjacent FCP LUN referencing each subsequent SCSI device. The index table generated by the Auto Assigned option cannot be manually edited.

When the Auto Assigned option is used, the host system will detect every attached SCSI device without voids, allowing full device access to the host. This method allows easy configuration in environments where SCSI device ordering is not important and where hot plugging of SCSI devices will not occur. For example, tape libraries are excellent candidates for using Auto Assigned Addressing. Configuration options provide for the SCSI discovery to be performed in order of bus, target, or LUN as desired for the specific environment.

Indexed Addressing Method

Indexed addressing allows for host bus adapter (HBA) drivers that use only Peripheral Device Addressing to access SCSI devices attached to the router. This addressing is done by use of a table, which is indexed by sequential LUN values, indicating the selected BUS:TARGET:LUN devices. In this mode, it is not possible to address the router as a controller unit directly.

The maximum size of the table is equal to the number of buses multiplied by the number of targets per bus less one Initiator ID per bus, multiplied by the number of LUNs per target. The index table can be manually edited. A method is also provided to perform SCSI device discovery and fill the index table.

See [Table 25](#) for the Indexed addressing table.

Table 25: Indexed Addressing Table

FCP LUN Value	SCSI BUS:TARGET:LUN
0	0:0:0
1	0:1:0
2	0:2:0
3	0:3:0
4	0:4:0
5	0:5:0
6	0:6:0
	(0:7:0 occupied by Initiator ID)
7	0:8:0
(...)	(...)
13	0:14:0
14	0:15:0
15	1:0:0
16	1:1:0
17	1:2:0
(...)	(...)

Regulatory Compliance Notices



Federal Communications Commission Notice

Part 15 of the Federal Communications Commission (FCC) Rules and Regulations has established Radio Frequency (RF) emission limits to provide an interference-free radio frequency spectrum. Many electronic devices, including computers, generate RF energy incidental to their intended function and are, therefore, covered by these rules. These rules place computers and related peripheral devices into two classes, A and B, depending upon their intended installation. Class A devices are those that may reasonably be expected to be installed in a business or commercial environment. Class B devices are those that may reasonably be expected to be installed in a residential environment (for example, personal computers). The FCC requires devices in both classes to bear a label indicating the interference potential of the device as well as additional operating instructions for the user.

The rating label on the device shows the classification (A or B) of the equipment. Class B devices have an FCC logo or FCC ID on the label. Class A devices do not have an FCC logo or FCC ID on the label. After the Class of the device is determined, refer to the corresponding statement in the following sections.

Class A Equipment

This equipment has been tested and found to comply with the limits for a Class A digital device, pursuant to Part 15 of the FCC Rules. These limits are designed to provide reasonable protection against harmful interference when the equipment is operated in a commercial environment. This equipment generates, uses, and can radiate radio frequency energy and, if not installed and used in accordance with the instructions, may cause harmful interference to radio communications. Operation of this equipment in a residential area is likely to cause harmful interference, in which case the user will be required to correct the interference at personal expense.

Class B Equipment

This equipment has been tested and found to comply with the limits for a Class B digital device, pursuant to Part 15 of the FCC Rules. These limits are designed to provide reasonable protection against harmful interference in a residential installation. This equipment generates, uses, and can radiate radio frequency energy and, if not installed and used in accordance with the instructions, may cause harmful interference to radio communications. However, there is no guarantee that interference will not occur in a particular installation. If this equipment does cause harmful interference to radio or television reception, which can be determined by turning the equipment off and on, the user is encouraged to try to correct the interference by one or more of the following measures:

- Reorient or relocate the receiving antenna
- Increase the separation between the equipment and receiver
- Connect the equipment into an outlet on a circuit that is different from that to which the receiver is connected
- Consult the dealer or an experienced radio or television technician for help

Designation Clarification

MSL libraries are Class A devices with the HP StorageWorks Network Storage Router e1200-160 installed.

Declaration of Conformity for Products Marked with the FCC Logo, United States Only

This device complies with Part 15 of the FCC Rules. Operation is subject to the following two conditions: (1) this device may not cause harmful interference, and (2) this device must accept any interference received, including interference that may cause undesired operation.

For questions regarding this FCC declaration, contact us by mail or telephone:

Hewlett-Packard Company
Network Storage Solutions - Automation Business Segment
Regulatory Engineering
825 14th Street S.W., Bldg. E, MS E200
Loveland, CO 80537

(970) 898-1738

To identify this product, refer to the part, series, or model number found on the product.

Canadian Notice (Avis Canadien)

Class A Equipment

This Class A digital apparatus meets all requirements of the Canadian Interference-Causing Equipment Regulations.

Cet appareil numérique de la classe A respecte toutes les exigences du Règlement sur le matériel brouilleur du Canada.

Class B Equipment

This Class B digital apparatus meets all requirements of the Canadian Interference-Causing Equipment Regulations.

Cet appareil numérique de la classe B respecte toutes les exigences du Règlement sur le matériel brouilleur du Canada.

European Union Notice

Products with the CE Marking comply with both the EMC Directive (89/336/EEC) and the Low Voltage Directive (73/23/EEC) issued by the Commission of the European Community.

Compliance with these directives implies conformity to the following European Norms (the equivalent international standards are in parenthesis):

- EN55022 (CISPR 22) – Electromagnetic Interference
- EN55024 (IEC61000-4-2, 3, 4, 5, 6, 8, 11) – Electromagnetic Immunity
- EN61000-3-2 (IEC61000-3-2) – Power Line Harmonics
- EN61000-3-3 (IEC61000-3-3) – Power Line Flicker
- EN60950 (IEC950) – Product Safety

Japanese Notice

ご使用になっている装置にVCCIマークが付いていましたら、次の説明文をお読み下さい。

この装置は、情報処理装置等電波障害自主規制協議会（VCCI）の基準に基づくクラスB情報技術装置です。この装置は、家庭環境で使用することを目的としていますが、この装置がラジオやテレビジョン受信機に近接して使用されると、受信障害を引き起こすことがあります。

取扱説明書に従って正しい取り扱いをして下さい。

VCCIマークが付いていない場合には、次の点にご注意下さい。

この装置は、情報処理装置等電波障害自主規制協議会（VCCI）の基準に基づくクラスA情報技術装置です。この装置を家庭環境で使用すると電波妨害を引き起こすことがあります。この場合には使用者が適切な対策を講ずるよう要求されることがあります。

BSMI Notice

警告使用者：

這是甲類的資訊產品，在居住的環境中使用時，可能會造成射頻干擾，在這種情況下，使用者會被要求採取某些適當的對策。

Laser Device

All HP systems equipped with a laser device comply with safety standards, including International Electrotechnical Commission (IEC) 825. With specific regard to the laser, the equipment complies with laser product performance standards set by government agencies as a Class 1 laser product. The product does not emit hazardous light; the beam is totally enclosed during all modes of customer operation and maintenance.

Laser Safety Warnings



WARNING: To reduce the risk of exposure to hazardous radiation:

- Do not try to open the laser device enclosure. There are no user-serviceable components inside.
 - Do not operate controls, make adjustments, or perform procedures to the laser device other than those specified herein.
 - Allow only HP authorized service technicians to repair the laser device.
-

Compliance with CDRH Regulations

The Center for Devices and Radiological Health (CDRH) of the U.S. Food and Drug Administration implemented regulations for laser products on August 2, 1976. These regulations apply to laser products manufactured from August 1, 1976. Compliance is mandatory for products marketed in the United States.

Compliance with International Regulations

All HP systems equipped with laser devices comply with appropriate safety standards including IEC 825.

Laser Product Label

A label is located on the surface of the HP supplied laser device.

Laser Information

Table 26: Laser Information

Feature	Description
Laser type	Semiconductor GaAlAs
Wave length	780 nm +/- 35 nm
Divergence angle	53.5 degrees +/- 0.5 degrees
Output power	Less than 0.2 mW or 10,869 W m ⁻² sr ⁻¹
Polarization	Circular 0.25
Numerical aperture	0.45 inches +/- 0.04 inches

Electrostatic Discharge



To avoid damaging equipment, be aware of the precautions you need to follow when setting up the system or handling parts. A discharge of static electricity from a finger or other conductor may damage system boards or other static-sensitive devices. This type of damage may reduce the life expectancy of the device.

To prevent electrostatic damage, observe the following precautions:

- Avoid hand contact by transporting and storing products in static-safe containers.
- Keep electrostatic-sensitive parts in their containers until they arrive at static-free workstations.
- Place parts on a grounded surface before removing them from their containers.
- Avoid touching pins, leads, or circuitry.
- Always be properly grounded when touching a static-sensitive component or assembly.

Grounding Methods

There are several methods for grounding. Use one or more of the following methods when handling or installing electrostatic-sensitive parts:

- Use a wrist strap connected by a ground cord to a grounded workstation or computer chassis. Wrist straps are flexible straps with a minimum of 1 megohm \pm 10 percent resistance in the ground cords. To provide proper ground, wear the strap snug against the skin.
- Use heel straps, toe straps, or boot straps at standing workstations. Wear the straps on both feet when standing on conductive floors or dissipating floor mats.
- Use conductive field service tools.
- Use a portable field service kit with a folding static-dissipating work mat.

If you do not have any of the suggested equipment for proper grounding, have a HP authorized reseller install the part.

Note: For more information on static electricity, or assistance with product installation, contact your HP authorized reseller.

A

- Active Fabric configuration
 - Serial/Telnet UI [128](#)
 - Visual Manager UI [50](#)
- addressing, defined [173](#)
- audience [10](#)
- authorized reseller, HP [15](#)
- auto-assigned addressing
 - described [176](#)
- auto-assigned maps, defined [32](#)

B

- backing up the configuration, FTP UI [147](#)
- backup and restore, LAN-free, illustrated [23](#)
- baud rate configuration
 - Serial/Telnet UI [97](#)
 - Visual Manager UI [46](#)
- buffered tape writes
 - Fibre Channel
 - Serial/Telnet UI [103](#)
 - Visual Manager UI [58](#)
 - overview of [33](#)
 - SCSI
 - Serial/Telnet UI [107](#)
 - Visual Manager UI [61](#)
- bus reset on boot
 - overview of [29](#)
 - Serial/Telnet UI [106](#)
 - Visual Manager UI [61](#)

C

- Center for Devices and Radiological Health See CDRH
- clock configuration
 - Serial/Telnet UI [127](#)
 - Visual Manager UI [52](#)
- configuration settings
 - backing up [147](#)
 - common [29](#)
 - restoring [148](#)
 - troubleshooting [157](#)
- configurations, Fibre Channel to SCSI, illustrated [20](#)
- controller LUN commands
 - general commands, listed [168](#)
- conventions
 - document [11](#)
 - equipment symbols [12](#)
 - text symbols [12](#)
- conversion process, FCP to SCSI protocol, illustrated [21](#)
- copying trace buffers, FTP UI [149](#)
- current map, default
 - Fibre Channel
 - Serial/Telnet UI [103](#)
 - Visual Manager UI [58](#)
 - SCSI
 - Serial/Telnet UI [107](#)
 - Visual Manager UI [62](#)

D

- date configuration

- Serial/Telnet UI [127](#)
- Visual Manager UI [52](#)
- DB-9 pin assignments [164](#)
- DB-9 pin layout [164](#)
- DB-9 serial pin assignments, illustrated [164](#)
- default settings, Ethernet [26](#)
- default settings, router [26](#)
- devices
 - supported [20](#)
 - troubleshooting [157](#)
- DHCP setup
 - Serial/Telnet UI [100](#)
 - Visual Manager UI [49](#)
- discovery mode
 - Fibre Channel
 - Serial/Telnet UI [102](#)
 - Visual Manager UI [57](#)
 - overview of [30](#)
 - SCSI
 - Serial/Telnet UI [106](#)
 - Visual Manager UI [61](#)
- document
 - conventions [11](#)
 - prerequisites [10](#)
 - related documentation [10](#)

E

- environmental requirements
 - operating [23](#)
 - shipping and storing [24](#)
- equipment symbols [12](#)
- ESD (electrostatic discharge)
 - obtaining additional information [188](#)
 - precautions [187](#)
 - preventing [187](#)
 - transporting products [187](#)
- Ethernet configuration
 - default settings [26](#)
 - Serial/Telnet UI [99](#)
 - Visual Manager UI [48](#)
- Ethernet port
 - LED indicators [19](#)

- location of [19](#)
- event log
 - clearing
 - Serial/Telnet UI [139](#)
 - Visual Manager UI [85](#)
 - configuration of
 - Serial/Telnet UI [127](#)
 - Visual Manager UI [83](#)
 - viewing
 - Serial/Telnet UI [139](#)
 - Visual Manager UI [84](#)
- external features, overview [18](#)

F

- factory settings, resetting
 - Serial/Telnet UI [129](#)
 - Visual Manager UI [53](#)
- FCC notices
 - Class A Equipment [180](#)
 - Class B Equipment [180](#)
 - classification label [179](#)
 - Declaration of Conformity [181](#)
- FCP to SCSI protocol conversion process, illustrated [21](#)
- features of router, external [18](#)
- Fibre Channel
 - LED indicators [19](#)
 - port configuration, overview [30](#)
- Fibre Channel connection, troubleshooting [156](#)
- Fibre Channel hosts
 - viewing and changing
 - Serial/Telnet UI [118](#)
 - Visual Manager UI [68](#)
- Fibre Channel maps
 - adding entries
 - Serial/Telnet UI [114](#)
 - Visual Manager UI [70](#)
 - clearing entries
 - Visual Manager UI [69](#)
 - creating entries
 - Serial/Telnet UI [115](#)
 - Visual Manager UI [70](#)

- deleting entries
 - Serial/Telnet UI [118](#)
 - Visual Manager UI [69](#)
 - editing entries
 - Serial/Telnet UI [112](#)
 - Visual Manager [69](#)
 - filling entries
 - Serial/Telnet UI [118](#)
 - Visual Manager UI [69](#)
 - removing gaps in
 - Serial/Telnet UI [117](#)
 - Visual Manager UI [69](#)
 - viewing and changing
 - Serial/Telnet UI [110](#)
 - Visual Manager UI [69](#)
 - Fibre Channel port
 - buffered tape writes
 - Serial/Telnet UI [103](#)
 - Visual Manager UI [58](#)
 - configuration
 - Serial/Telnet UI [101](#)
 - Visual Manager UI [56](#)
 - Configuration screen, illustrated [56](#)
 - default map
 - Serial/Telnet UI [103](#)
 - Visual Manager UI [58](#)
 - discovery mode
 - Serial/Telnet UI [102](#)
 - Visual Manager UI [57](#)
 - override settings
 - Serial/Telnet UI [103](#)
 - Visual Manager UI [59](#)
 - performance mode
 - Visual Manager UI [59](#)
 - port mode
 - Serial/Telnet UI [103](#)
 - Visual Manager UI [57](#)
 - port name
 - Serial/Telnet UI [102](#)
 - Visual Manager UI [56](#)
 - Fibre Channel to SCSI configurations, illustrated [20](#)
 - firmware versions, upgrading
 - FTP UI [150](#)
 - Serial/Telnet UI [142](#)
 - FTP UI
 - accessing [146](#)
 - Visual Manager UI [77](#)
 - configuration, backing up [147](#)
 - configuration, restoring [148](#)
 - firmware, upgrading [150](#)
 - overview of the UI [28](#)
 - tasks [145](#)
 - trace buffers, copying [149](#)
 - functional overview, of router [20](#)
- ## G
- getting help [14](#)
 - grounding methods [188](#)
 - grounding, suggested equipment for [188](#)
- ## H
- HBA device driver, troubleshooting [158](#)
 - heel straps, using [188](#)
 - help, obtaining [14](#)
 - host configuration, troubleshooting [158](#)
 - host lists
 - adding to
 - Serial/Telnet UI [120](#)
 - deleting from
 - Serial/Telnet UI [121](#)
 - editing, Fibre Channel
 - Serial/Telnet UI [120](#)
 - Visual Manager UI [68](#)
 - editing, SCSI
 - Serial/Telnet UI [121](#)
 - Visual Manager UI [71](#)
 - selecting a host for the current map
 - Serial/Telnet UI [120](#)
 - Visual Manager UI [66](#)
 - hostname
 - Serial/Telnet UI [99](#)
 - Visual Manager UI [47](#)

HP

- authorized reseller [15](#)
- storage website [14](#)
- technical support [14](#)

I

I/O configuration

- Visual Manager UI [54](#)

indexed addressing

- described [177](#)

indexed maps, defined [32](#)

initiator IDs, SCSI

- Serial/Telnet UI [106](#)
- Visual Manager UI [60](#)

interfaces

- user, listed [27](#)

internal termination, SCSI

- Visual Manager UI [61](#)

IP address

- Serial/Telnet UI [99](#)
- Visual Manager UI [49](#)

IP gateway

- Serial/Telnet UI [99](#)
- Visual Manager UI [49](#)

LLAN-free backup and restore, illustrated [23](#)

laser device

- product classification label [185](#)
- radiation warning [184](#)
- regulatory compliance notice [184](#)

LED indicators

- defined [153](#)
- Ethernet port [19](#)
- Fibre Channel [19](#)
- power supply [19](#)
- SCSI bus [19](#)
- types of [153](#)

Library and Tape Tools [160](#)Library and Tape Tools, Additional information [162](#)Library and Tape Tools, Getting support [162](#)Library and Tape Tools, Key features [160](#)Library and Tape Tools, Software features [160](#)

link status, Fibre Channel

- Serial/Telnet UI [133](#)
- Visual Manager UI [56](#)

LUN management

- overview [31](#)

M

mapping tasks, Fibre Channel

adding entries

- Serial/Telnet UI [114](#)
- Visual Manager [70](#)

changing the name of the host

- Visual Manager [68](#)

clearing entries

- Visual Manager [69](#)

creating entries

- Serial/Telnet UI [115](#)
- Visual Manager [70](#)

default current map

- Serial/Telnet UI [103](#)
- Visual Manager UI [58](#)

deleting entries

- Serial/Telnet UI [118](#)
- Visual Manager [69](#)

filling entries

- Serial/Telnet UI [118](#)
- Visual Manager [69](#)

removing gaps in

- Serial/Telnet UI [117](#)
- Visual Manager [69](#)

viewing and changing [108](#)

- Visual Manager UI [69](#)

mapping tasks, Fibre Channel and SCSI

adding (creating) a map

- Visual Manager UI [67](#)

adding a host to the host list

- Serial/Telnet UI [120](#)

changing the name of

- Serial/Telnet UI [112](#)

- deleting (removing) the current map
 - Visual Manager UI [67](#)
- deleting a host from the host list
 - Serial/Telnet UI [121](#)
 - Visual Manager UI [66](#)
- displaying the entire device list
 - Serial/Telnet UI [123](#)
- editing entries
 - Serial/Telnet UI [112](#)
- editing host information
 - Serial/Telnet UI [121](#)
- editing the current map
 - Serial/Telnet UI [111](#)
- editing the host list of the current map
 - Serial/Telnet UI [118](#)
- overview of
 - Visual Manager UI [65](#)
- selecting a host for the current map
 - Serial/Telnet UI [120](#)
 - Visual Manager UI [66](#)
- selecting the current map
 - Serial/Telnet UI [109](#)
 - Visual Manager UI [67](#)
- viewing and changing
 - Serial/Telnet UI [110](#)
 - Visual Manager UI [66](#)
- mapping tasks, SCSI
 - adding entries
 - Serial/Telnet UI [115](#)
 - Visual Manager UI [73](#)
 - clearing entries
 - Visual Manager UI [73](#)
 - creating entries
 - Serial/Telnet UI [116](#)
 - Visual Manager UI [73](#)
 - default current map
 - Serial/Telnet UI [107](#)
 - Visual Manager UI [62](#)
 - deleting entries
 - Serial/Telnet UI [118](#)
 - Visual Manager UI [73](#)
 - filling entries

- Serial/Telnet UI [118](#)
- Visual Manager UI [73](#)
- removing gaps in
 - Serial/Telnet UI [117](#)
 - Visual Manager UI [73](#)
- viewing and changing [108](#)
 - Visual Manager UI [72](#)
- maps
 - auto-assigned, defined [32](#)
 - indexed, defined [32](#)
 - overview [31](#)
 - predefined maps [32](#)
 - SCC, defined [32](#)
 - troubleshooting [157](#)

N

- network configuration
 - Serial/Telnet UI [98](#)
 - Visual Manager UI [47](#)

O

- override settings
 - Fibre Channel
 - Serial/Telnet UI [103](#)
 - Visual Manager UI [59](#)
 - SCSI
 - Serial/Telnet UI [107](#)
 - Visual Manager UI [62](#)

P

- parts
 - proper handling [187](#)
 - storing [187](#)
- performance mode, Fibre Channel
 - Visual Manager UI [59](#)
- pin assignments
 - DB-9 serial [164](#)
 - RJ-45 Ethernet [165](#)
- pin layout
 - DB-9 serial [164](#)
 - RJ-45 Ethernet [165](#)

- port configuration
 - Serial/Telnet UI [101](#)
- port mode, Fibre Channel
 - Serial/Telnet UI [103](#)
 - Visual Manager UI [57](#)
- port name, Fibre Channel
 - Serial/Telnet UI [102](#)
 - Visual Manager UI [56](#)
- power requirements, of router [24](#)
- power supply
 - LED indicators [19](#)
- power-up messages, illustrated [94](#)
- prerequisites [10](#)
- PRLI data, troubleshooting [159](#)
- process, converting Fibre Channel to SCSI, illustrated [21](#)
- process, converting SCSI to Fibre Channel, illustrated [22](#)

R

- rack stability, warning [13](#)
- rebooting
 - Serial/Telnet UI [142](#)
 - Visual Manager UI [87](#)
- regulatory compliance notices
 - Canadian [182](#)
 - European Union [182](#)
- related documentation [10](#)
- report option
 - Visual Manager UI [86](#)
- requirements of router, physical [23](#)
- resetting to factory settings
 - Serial/Telnet UI [129](#)
 - Visual Manager UI [53](#)
- restoring the configuration, FTP UI [148](#)
- RJ-45 Ethernet pin assignments [165](#)
- RJ-45 Ethernet pin layout [165](#)
- RJ-45 Ethernet pin layout, illustrated [165](#)
- router, illustrated [18](#), [153](#)

S

- SCC addressing, described [176](#)
- SCC maps, defined [32](#)
- SCSI bus
 - buffered tape writes
 - Serial/Telnet UI [107](#)
 - Visual Manager UI [61](#)
 - bus reset on boot
 - Serial/Telnet UI [106](#)
 - Visual Manager UI [61](#)
 - configuration of
 - Serial/Telnet UI [105](#)
 - Visual Manager UI [60](#)
 - configuration overview [29](#)
 - configuration, troubleshooting [155](#)
 - default map
 - Serial/Telnet UI [107](#)
 - Visual Manager UI [62](#)
 - discovery settings
 - Serial/Telnet UI [106](#)
 - Visual Manager UI [61](#)
 - Initiator and Target settings
 - Serial/Telnet UI [106](#)
 - Visual Manager UI [60](#)
 - LED indicators [19](#)
 - override settings [107](#)
 - Visual Manager UI [62](#)
 - termination mode
 - Visual Manager UI [61](#)
- SCSI devices, troubleshooting [157](#)
- SCSI hosts
 - viewing and changing
 - Serial/Telnet UI [118](#)
 - Visual Manager UI [71](#)
- SCSI maps
 - adding entries
 - Serial/Telnet UI [115](#)
 - Visual Manager UI [73](#)
 - clearing entries
 - Visual Manager UI [73](#)
 - creating entries

- Serial/Telnet UI [116](#)
- Visual Manager UI [73](#)
- deleting entries
 - Serial/Telnet UI [118](#)
 - Visual Manager UI [73](#)
- editing entries
 - Serial/Telnet UI [112](#)
 - Visual Manager [72](#)
- filling entries
 - Serial/Telnet UI [118](#)
 - Visual Manager UI [73](#)
- removing gaps in
 - Serial/Telnet UI [117](#)
 - Visual Manager UI [73](#)
- viewing and changing
 - Serial/Telnet UI [110](#)
 - Visual Manager UI [72](#)
- SCSI to Fibre Channel conversion process, illustrated [22](#)
- security configuration
 - Serial/Telnet UI [100](#)
 - Visual Manager UI [51](#)
- serial port
 - configuration, troubleshooting of [93](#), [158](#)
 - location of [19](#)
- Serial UI, accessing [92](#)
- Serial/Telnet main menu, illustrated [95](#)
- Serial/Telnet UI
 - accessing [92](#)
 - Active Fabric configuration [128](#)
 - baud rate, changing [97](#)
 - Configuration Menu, options, listed [96](#)
 - DHCP setup [100](#)
 - download new firmware option, described [142](#)
 - editing host information on a Fibre Channel port, illustrated [122](#)
 - Ethernet configuration [98](#)
 - DHCP [100](#)
 - Ethernet mode [99](#)
 - I/P address [99](#)
 - I/P gateway [99](#)
 - MAC address [99](#)
 - subnet mask [99](#)
 - event filter setting options, listed [127](#)
 - event log
 - clearing [139](#)
 - configuration of [126](#)
 - viewing [139](#)
 - event settings, configuration of [126](#)
 - factory settings, resetting [129](#)
 - Fibre Channel devices, viewing [135](#)
 - Fibre Channel driver status information, viewing [136](#)
 - Fibre Channel link information, viewing [133](#)
 - Fibre Channel port
 - buffered tape writes [103](#)
 - configuration of [101](#)
 - discovery mode [102](#)
 - override settings [103](#)
 - port mode [103](#)
 - port name [102](#)
 - Fibre Channel status information, viewing [132](#)
 - main menu, described [95](#)
 - mapping tasks, Fibre Channel
 - adding entries [114](#)
 - creating entries [115](#)
 - deleting entries [118](#)
 - filling entries in [118](#)
 - removing gaps in [117](#)
 - mapping tasks, Fibre Channel and SCSI
 - adding a host to the host list [120](#)
 - changing the name of the current map [112](#)
 - deleting a host from the host list [121](#)
 - displaying the entire device list [123](#)
 - editing entries of the current map [112](#)
 - editing host information [121](#)
 - editing options, listed [112](#)
 - editing the current map [111](#)
 - editing the entries of the current map, options, listed [113](#)
 - editing the host list of the current map [118](#)

- editing the host list of the current map, edit options, listed [119](#)
- initial access [108](#)
- listed [109](#)
- screen navigation [109](#)
- selecting the current map [109](#)
- selecting the host for the current map [120](#)
- viewing the current map [110](#)
- mapping tasks,SCSI
 - adding entries [115](#)
 - creating map entries [116](#)
 - deleting entries [118](#)
 - filling entries [118](#)
 - removing gaps in [117](#)
- overview of the UI [27](#)
- port configuration [101](#)
- reboot option, described [142](#)
- Reset and Save Configuration to Factory defaults option, described [129](#)
- Restore Last Saved Configuration option, described [129](#)
- Save Configuration option, described [128](#)
- SCSI attached devices [137](#)
- SCSI bus, configuration
 - buffered tape writes [107](#)
 - bus reset on boot [106](#)
 - discovery settings [106](#)
 - Initiator and Target settings [106](#)
 - Target override settings [107](#)
- SCSI resource information [138](#)
- SCSI statistics [137](#)
- SCSI status information [137](#)
- SCSI Status Menu, options, listed [137](#)
- system statistics information, described [131](#)
- System Statistics Menu, options, listed [131](#)
- system status information [131](#)
- System Utilities Menu, options, listed [130](#)
- System Utility Menu, described [130](#)
- trace and event settings configuration, described [124](#)
- trace buffers, saving copies [140](#)
- Trace Dump menu, described [140](#)
- trace settings, configuring [125](#)
- Serial/Telnet UI Active Fabric Configuration Menu, illustrated [128](#)
- Serial/Telnet UI adding a host to the host list - FCP host, illustrated [121](#)
- Serial/Telnet UI Baud Rate Configuration screen, illustrated [97](#)
- Serial/Telnet UI Configuration Menu, illustrated [96](#)
- Serial/Telnet UI creating an entry for a SCSI map, illustrated [117](#)
- Serial/Telnet UI creating a map entry for a Fibre Channel map, illustrated [116](#)
- Serial/Telnet UI device list generated for a Fibre Channel port, illustrated [114](#)
- Serial/Telnet UI Device Mapping Configuration Menu, illustrated [108](#)
- Serial/Telnet UI Download New Firmware Menu, illustrated [143](#)
- Serial/Telnet UI Edit Map Entries for a Fibre Channel Map, illustrated [113](#)
- Serial/Telnet UI Edit Map Entries for a SCSI Map, illustrated [113](#)
- Serial/Telnet UI editing host information on a SCSI bus, illustrated [123](#)
- Serial/Telnet UI entire device list, illustrated [124](#)
- Serial/Telnet UI event filter settings, illustrated [126](#)
- Serial/Telnet UI Event Log Menu, illustrated [139](#)
- Serial/Telnet UI FCP Current Map display, illustrated [110](#)
- Serial/Telnet UI Fibre Channel configuration screen, illustrated [101](#)
- Serial/Telnet UI Fibre Channel Devices Display page, illustrated [135](#)
- Serial/Telnet UI Fibre Channel Driver resource status screen, illustrated [136](#)
- Serial/Telnet UI Fibre Channel link status screen, illustrated [133](#)
- Serial/Telnet UI Fibre Channel Status Menu, illustrated [132](#)

Serial/Telnet UI Fibre Channel Transport Queues page, illustrated [136](#)
Serial/Telnet UI host list display for Fibre Channel maps, illustrated [119](#)
Serial/Telnet UI host list display for SCSI maps, illustrated [119](#)
Serial/Telnet UI RealTime Clock Configuration Menu, described [127](#)
Serial/Telnet UI SCSI bus configuration menu, illustrated [105](#)
Serial/Telnet UI SCSI Current Map display, illustrated [111](#)
Serial/Telnet UI SCSI Device Display Menu, illustrated [138](#)
Serial/Telnet UI SCSI Resource Display screen, illustrated [139](#)
Serial/Telnet UI SCSI Status Menu, illustrated [137](#)
Serial/Telnet UI Select Current Map screen, illustrated [109](#)
Serial/Telnet UI System Statistics Menu, illustrated [131](#)
Serial/Telnet UI System Status screen, illustrated [132](#)
Serial/Telnet UI Trace Dump menu, illustrated [140](#)
Serial/Telnet UI trace settings menu, illustrated [124](#)
Serial/Telnet UI trace settings screen, continued, illustrated [126](#)
settings, common configuration [29](#)
standby power button
 location of [19](#)
statistics information, viewing
 Serial/Telnet UI [131](#)
 Visual Manager UI [74](#)
subnet mask
 Serial/Telnet UI [99](#)
 Visual Manager UI [49](#)
symbols in text [12](#)
symbols on equipment [12](#)

T

tables
 peripheral device addressing [174](#)
 SCSI addressing sequence [174](#)
 SCSI logical unit addressing [174](#)
target override settings
 Serial/Telnet UI [107](#)
 Visual Manager [62](#)
technical support, HP [14](#)
Telnet UI, accessing [92](#)
text symbols [12](#)
tools
 conductive field service type [188](#)
traces
 clearing buffers
 Serial/Telnet UI [140](#)
 Visual Manager UI [82](#)
 configuration
 Serial/Telnet UI [140](#)
 configuration of
 Serial/Telnet UI [125](#)
 Visual Manager UI [79](#)
 copying buffers [149](#)
 viewing
 Serial/Telnet UI [140](#)
troubleshooting
 basic steps, listed [155](#)
 devices, verifying [157](#)
 Fibre Channel connection, verifying [156](#)
 HBA device driver, verifying [158](#)
 host configuration, verifying [158](#)
 mapping, verifying [157](#)
 PRLI data, verifying [159](#)
 router configuration, verifying [157](#)
 SCSI bus configuration [155](#)
 SCSI devices, verifying [157](#)
 serial port configuration, verifying [93](#), [158](#)

U

upgrading the firmware
 FTP UI [150](#)

- Serial/Telnet UI [142](#)
- user configuration
 - Serial/Telnet UI [100](#)
 - Visual Manager UI [51](#)
- user interfaces, listed [27](#)
- utilities configuration
 - Serial/Telnet UI [130](#)
 - Visual Manager UI [75](#)

V

- Visual Manager Clear Current Trace Buffer screen, illustrated [82](#)
- Visual Manager Current traces screen, illustrated [81](#)
- Visual Manager Discovery screen, illustrated [64](#)
- Visual Manager Ethernet Configuration dialog box, illustrated [48](#)
- Visual Manager Event Log settings screen, illustrated [83](#)
- Visual Manager FTP Utility screen, illustrated [77](#)
- Visual Manager Home page, illustrated [41](#)
- Visual Manager main menu, illustrated [41](#)
- Visual Manager Network screen, illustrated [47](#)
- Visual Manager Ports menu, illustrated [54](#)
- Visual Manager Reboot screen, illustrated [87](#)
- Visual Manager Report screen, illustrated [86](#)
- Visual Manager Reset to Factory Default screen, illustrated [53](#)
- Visual Manager router image, illustrated [42](#)
- Visual Manager SCSI bus configuration screen, illustrated [60](#)
- Visual Manager SCSI Host Name dialog box, illustrated [71](#)
- Visual Manager SCSI Map dialog box, illustrated [72](#)
- Visual Manager Serial screen, illustrated [46](#)
- Visual Manager Statistics menu, illustrated [74](#)
- Visual Manager System Menu, illustrated [44](#)
- Visual Manager Trace Settings screen, illustrated [79](#)
- Visual Manager UI
 - accessing [38](#)
 - Active Fabric configuration [50](#)
 - number of controller LUNs [50](#)
 - options [50](#)
 - baud rate configuration [46](#)
 - best practices [40](#)
 - clock configuration [52](#)
 - discovery [64](#)
 - Ethernet configuration [48](#)
 - DHCP [49](#)
 - Ethernet mode [48](#)
 - IP address [49](#)
 - IP gateway [49](#)
 - subnet mask [49](#)
 - event log
 - clearing [85](#)
 - configuration [83](#)
 - display [84](#)
 - factory settings, resetting [53](#)
 - Fibre Channel
 - buffered tape writes [58](#)
 - configuration of [56](#)
 - default map [58](#)
 - discovery mode [57](#)
 - hard AL_PA [57](#)
 - link status [56](#)
 - override settings [59](#)
 - performance mode [59](#)
 - port mode [57](#)
 - port name [56](#)
 - Fibre Channel hosts, viewing and changing [68](#)
 - FTP access [77](#)
 - home page [41](#)
 - host name, changing [47](#)
 - I/O configuration [54](#)
 - main menu [41](#)
 - mapping tasks [65](#)
 - overview of [65](#)
 - mapping tasks, Fibre Channel
 - adding entries [70](#)
 - clearing maps [69](#)
 - creating entries [70](#)

- deleting entries [69](#)
 - filling maps [69](#)
 - removing gaps in [69](#)
 - viewing and changing [69](#)
 - mapping tasks, Fibre Channel and SCSI
 - adding a new map [67](#)
 - deleting a host [66](#)
 - deleting a map [67](#)
 - selecting a host [66](#)
 - selecting a map [67](#)
 - mapping tasks, SCSI
 - adding entries [73](#)
 - clearing map entries [73](#)
 - creating entries [73](#)
 - deleting entries [73](#)
 - filling maps [73](#)
 - removing gaps in [73](#)
 - viewing and changing [72](#)
 - network configuration [47](#)
 - Network Menu options, listed [47](#)
 - overview of the UI [27](#)
 - reboot option [87](#)
 - report options [86](#)
 - resetting to factory settings [53](#)
 - SCSI
 - buffered tape writes [61](#)
 - bus reset on boot [61](#)
 - configuration of [60](#)
 - default map [62](#)
 - discovery mode [61](#)
 - initiator IDs [60](#)
 - internal termination [61](#)
 - override settings [62](#)
 - settings [60](#)
 - Target IDs [60](#)
 - SCSI hosts
 - viewing and changing [71](#)
 - serial configuration [46](#)
 - statistics information, viewing [74](#)
 - System Menu [44](#)
 - traces
 - clearing buffers [82](#)
 - configuration [79](#)
 - displays XE [81](#)
 - user configuration [51](#)
 - utilities configuration [75](#)
 - options [75](#)
 - Visual Manager Utilities menu, illustrated [75](#)
- ## W
- warning
 - rack stability [13](#)
 - symbols on equipment [12](#)
 - websites
 - HP storage [14](#)
 - wrist straps
 - using [188](#)

