

# invasor

1. Usa papel carta (8.5" x 11").
2. Comienza con el papel doblado a la mitad.
3. Dobra los puntos rojos hacia los puntos naranjas.
4. Trata de hacer tus dobleces lo más preciso posible.
5. Marca y dobla sobre las líneas punteadas.
6. Asegúrate de presionar bien los dobleces.

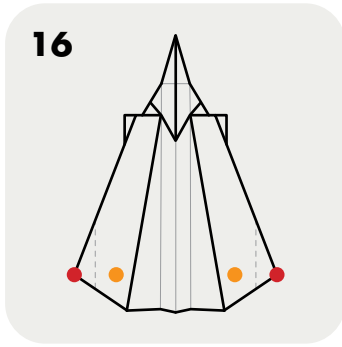

invent

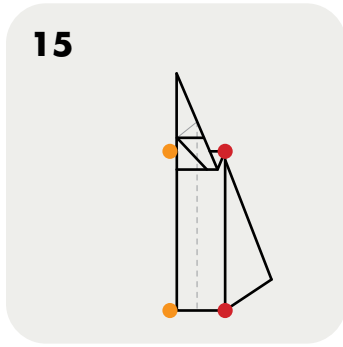
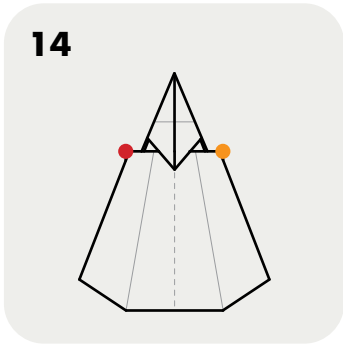
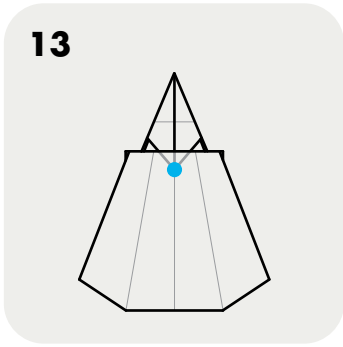
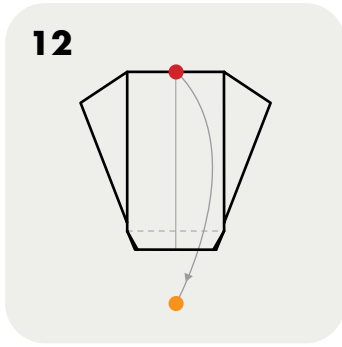
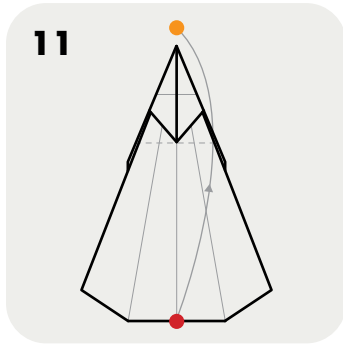
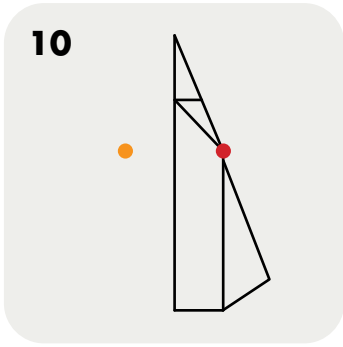
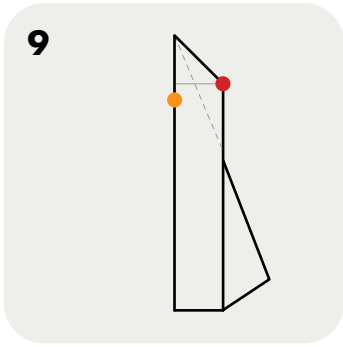
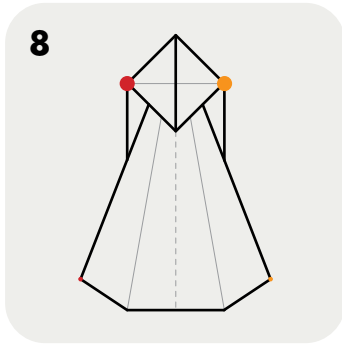
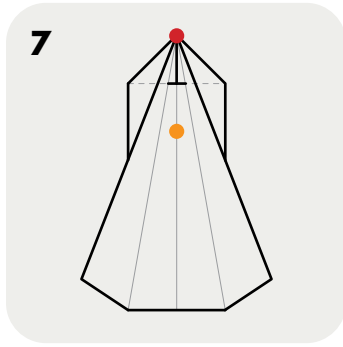
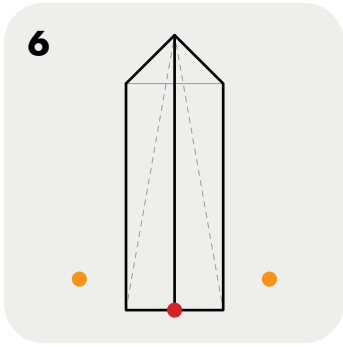
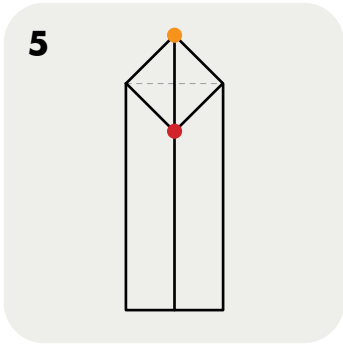
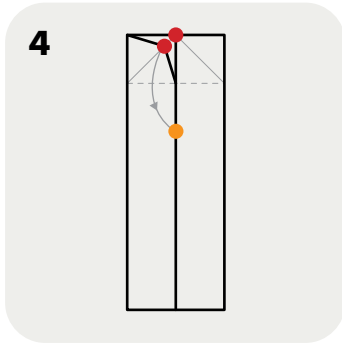
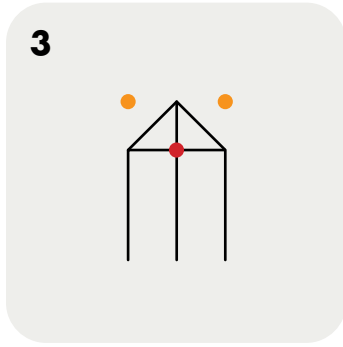
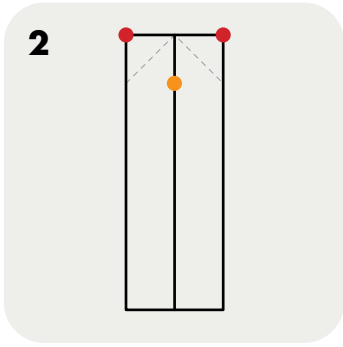
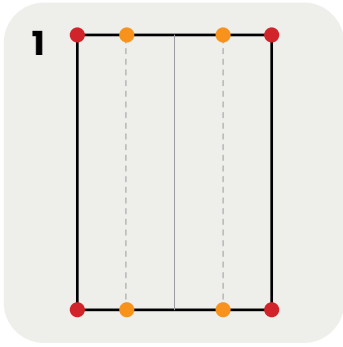

**INVASOR**

