

PERKIN-ELMER
Wangco Division

**INTERFACE
SPECIFICATION
FOR
MODEL 76S
DISKETTE DRIVE**

620312 - 001

WANGCO INC.
INTERFACE MANUAL
ORBIS MODEL 76S DISKETTE DRIVE

Wangco Part No.
620312-001 A

MODEL 76S DISKETTE DRIVE

TABLE OF CONTENTS

	SECTION/PAGE
1.0 Introduction	1 - 1
1.1 General	1 - 1
1.2 Performance Specification Model 76S	1 - 3
1.2.1 Features	1 - 3
1.2.2 Power Requirements	1 - 3
1.2.3 Power Dissipation Maximum	1 - 3
1.2.4 Operating Environment	1 - 3
1.2.5 Dimensions	1 - 3
2.0 Product Description	2 - 4
2.1 General	2 - 4
2.2 Operation - Model 76S	2 - 4
2.2.1 Diskette Drive Mechanism	2 - 4
2.2.2 Head Positioning Mechanism	2 - 4
2.2.3 Head Load Actuator	2 - 7
2.2.4 Control Electronics	2 - 7
2.2.5 Read/Write Head	2 - 7
2.2.6 Positive Operator Interlock	2 - 7
3.0 Interface Description - Model 76S	3 - 8
3.1 Daisy Chain Interface	3 - 8
3.2 Input Lines	3 - 10
3.2.1 Input Line Termination (Socket RN 2)	3 - 10
3.2.2 Drive Select 1-4 (Pins 26,28,30 & 32 & Trace S1)	3 - 11

3.2.3	Direction Select (Pin 34)	3	-	11
3.2.4	Step (Pin 36)	3	-	11
3.2.5	Write Gate (Pin 40)	3	-	12
3.2.6	Write Data (Pin 38)	3	-	12
3.2.7	Head Load (Optional Input Trace HL)	3	-	12
3.2.8	Status Indicators (J2-31 thru J2-34)	3	-	12
3.3	Output Lines	3	-	12
3.3.1	Track 00 (Pin 42)	3	-	14
3.3.2	Index (Pin 20)	3	-	14
3.3.3	Sector (Pin 24)	3	-	14
3.3.4	Ready (Pin 22 & Traces R)	3	-	14
3.3.5	Read Data (Pin 46)	3	-	14
3.3.6	Separate Data, Separate Clock (Pin 48, Pin 50)	3	-	14
3.3.7	Write Protect (Optional Feature)	3	-	16
3.4	Enhanced Interface	3	-	17
3.5	Alternate I/O	3	-	18
3.6	Power Interface	3	-	18
3.6.1	AC Power	3	-	18
3.6.2	DC Power	3	-	19
4.0	Modes of Operation	4	-	20
4.1	Introduction	4	-	20
4.2	Power Up Mode	4	-	20
4.3	Drive Selection	4	-	20
4.4	Seek Mode	4	-	21
4.5	Write Mode	4	-	21
4.6	Read Mode	4	-	21
4.7	Power Down Mode	4	-	21

5.0 Physical Interface	
5.1 General	5 - 22
5.2 Primary Signal Interface Connector (SJ1)	5 - 22
5.3 DC Power Connector (SJ5)	5 - 26
5.4 AC Power Connector (J8)	5 - 26
5.5 Enhanced Interface Connector (J5)	5 - 27
6.0 Ancillary Products	6 - 28
6.1 Orbis 93 Storage Element	6 - 28
6.2 Orbis 94 Storage Element	6 - 28
6.3 Power Supplies	6 - 28
6.4 Systems	6 - 28
7.0 Options	7 - 30
7.1 Customer Installable Options	7 - 30
7.1.1 Select Drive Without Loading Head	7 - 30
7.1.2 Radial Head Load	7 - 33
7.1.3 Radial Ready	7 - 33
7.1.4 Radial Index Sensor	7 - 34
7.1.5 Drive Select - One to Eight Drives	7 - 35
7.1.6 Stepper Power Control Option	7 - 37
7.1.7 File Unsafe Logic	7 - 41
7.1.8 Option Board J4	7 - 41
7.2 Factory Installable Options	7 - 45
7.2.1 Write Protect	7 - 45
7.2.2 Write Enable	7 - 45
7.2.3 Status Indicators	7 - 45

7.2.4	Electronic Sector	7 - 48
7.2.5	Chassis Slide	7 - 48
7.2.6	Inhibit Stepping Further In Than Track 77	7 - 48
8.0	Recording Format	8 - 52
8.1	IBM	8 - 52
8.2	Index	8 - 52
8.3	Sector	8 - 52
9.0	Operation Procedures	
9.1	Introduction	9 - 56
9.2	Diskette Loading	9 - 56
9.3	Diskette Unloading	9 - 56
9.4	Diskette Handling	9 - 57
9.5	Error Detection and Correction	9 - 57
10.0	Maintenance and Reliability	
10.1	Design Life	10 - 59
10.2	Mean Time Between Failures	10 - 59
10.3	Mean Time To Repair	10 - 59
10.4	Recoverable Read Error Rate	10 - 59
10.5	Non Recoverable Read Error Rate	10 - 60
10.6	Access Positioning Error Rate	10 - 60
10.7	Interchangeability	10 - 60

LIST OF FIGURES

<u>FIGURE</u>	<u>TITLE</u>	<u>PAGE</u>
1	System Interconnection	1 - 2
2	Block Diagram	2 - 5
3	Head/Diskette Load Assembly	2 - 6
4	Interface Signals	3 - 9
5	Direction & Step Timing	3 - 13
6	Write Timing	3 - 13
7	32-Sector/Index Timing	3 - 15
8	Read Timing	3 - 15
9	Read Data	3 - 16
10	SJ1 Connector Dimensions	5 - 22
11	Interface Connector Locations	5 - 23
12	Physical Dimensions	5 - 24
13	Interface Connections	5 - 25
14	SJ5 Connector	5 - 26
15	J8 AC Power Connector	5 - 26
16	Enhanced Interface	5 - 27
17	Diskette Dimensions	6 - 29
18	Standard Drive Configuration	7 - 31
19	Select Drive Without HL	7 - 32
20	Radial HL Option	7 - 33
21	Radial Ready Option	7 - 34
22	Radial Index/Sector Option	7 - 34
23	One of 8 Drive Selection Option	7 - 36
24	Stepper Power Control Option	7 - 38
25	Stepper Power Control with Select	7 - 39
26	Stepper Power Control Alt. I/O	7 - 40
27	File Unsafe Logic Option	7 - 42
28	Option Board for J4	7 - 44
29	Write Enable Switch	7 - 46
30	Optional Indicators (LED)	7 - 47
31	32-Sector/Index Timing	7 - 49
32	Slide Mount Dimensions	7 - 50
33	Track 77 Switch Option	7 - 51
34	IBM Track Format (3740)	7 - 53
35	Index Format	7 - 54
36	32-Sector Format	7 - 55

1.0 INTRODUCTION

1.1 GENERAL

The ORBIS Model 76S Diskette Drive provides a highly reliable compact solution to the problems of low cost data storage. Each drive utilizes industry standard diskettes which provide 3.2 million bits of data with a data rate of 250,000 bits/second double frequency encoding (unformatted).

The ORBIS Model 76S provides a host interface via a .100 inch centers PWB edge connector with an industry compatible pinout for both dc power and signal/control. Additionally, a customer-installed jumper option allows the drive to be used in a number of different modes.

Employing the ORBIS Diskette Drive Family, the user can achieve 12.8 Mbits of data storage by interfacing four 76S Diskette Drives onto the user system in a daisy chain configuration (see Figure 1). It is a full capability unit containing electronics for interface, read, write, control, step and direction, data separation and sector generation.

The unit is fully IBM compatible and offers an unformatted data capacity of 3.2 Mbits per disk, 250 kbps data transfer rate and 6 mS access time track-to-track. It accepts unaltered standard media in all configurations and a positive operator interlock feature assures gentle handling of the media at all times. Overlay seek and rotational position sensing are available on the ORBIS 76S.

Increased capacity on each diskette may be effected by use of alternate and/or proprietary encoding techniques. For example, the information packing density may be doubled by use of MFM or Group-Coded recording (GCR). See Model 86 Data Encoder description (620224-001).

SYSTEM INTERCONNECTIONS 76S DISKETTE DRIVES

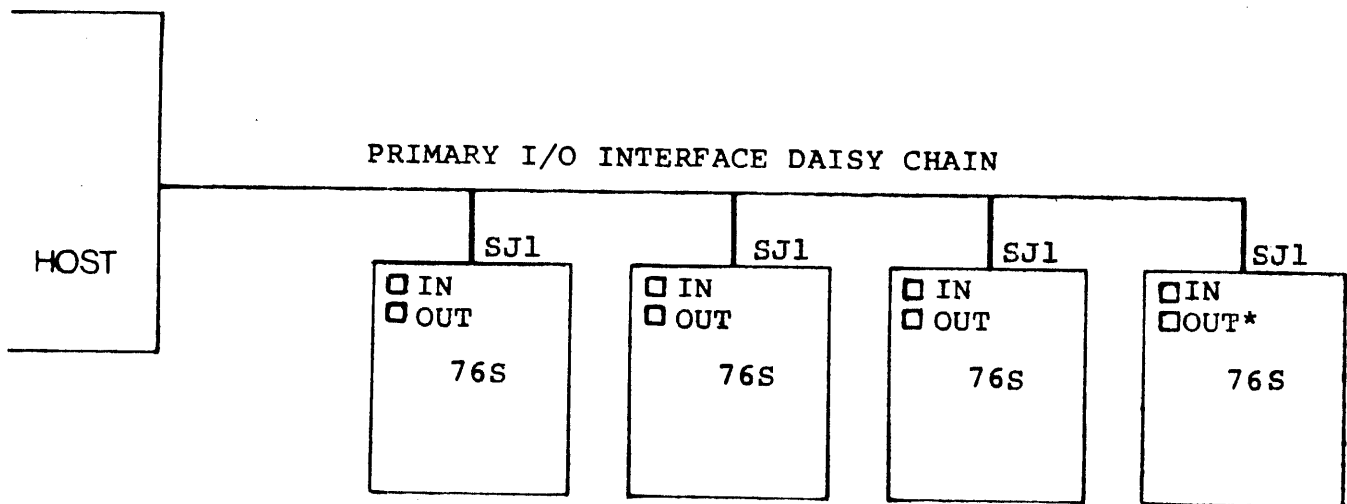

* For Primary I/O Cables longer than 20 feet install OUTPUT TERMINATOR as shown.

FIGURE 1
SYSTEMS INTERCONNECTIONS 76S DISKETTE DRIVES

1.2 PERFORMANCE SPECIFICATIONS, MODEL 76S

1.2.1 Features

Number of Disks	1
Capacity	
per disk	3.2 million bits unformatted
per track	41666 bits unformatted
Coding Technique	Double frequency (standard)
Head	Common read/write with tunnel erase
Transfer Rate	250 Kilobits/sec
Bit Density (Inner Track)	3268 BPI
Rotational Speed	360 RPM \pm 3%
Access Time	6 msec track to track may be concurrent
Head Load Time	16 msec
Head Settle Time	14 msec (additive to Access or Head Load Time)
Storage Element	IBM Diskette, ORBIS Model 93 or 33-hole media ORBIS Model 94
Recording surfaces	1
Number of tracks/Surface	77
Track spacing	48 track/inch
Index	1 per diskette
Sectors	32 (with 33-hole media)
UL Approval	UL recognized component

1.2.2 Power Requirements

100/115 VAC \pm 10%	50/60 Hz \pm .5 Hz	0.6 amps
208/230 VAC \pm 10%	50/60 Hz \pm .5 Hz	0.3 amps*
+5V DC \pm 5%	1.0 A	
+24V DC \pm 10%	1.2 A	

1.2.3 Power Dissipation Maximum

DC	40 watts
AC	40 watts

1.2.4 Operating Environment

Temperature Range	50 ^o - 100 ^o F
Relative Humidity Range	8% - 80% (No condensation)

1.2.5 Dimensions

Height	4.53 inches max.
Width	9.01 inches max.
Depth	14.124 inches max.
Weight	13 pounds

* 208/230V option (40099-001)

2.0 PRODUCT DESCRIPTION - MODEL 76S

2.1 GENERAL

The ORBIS Model 76S Diskette Drive is designed as a peripheral device to be attached to or made a part of a host system. Its functional characteristics are the ability to read or write on a standard diskette upon order for track and sector positioning, and to provide output signals as to unit status. This section describes the general operation of the units; subsequent sections provide detailed descriptions of 76S unit, performance and design criteria intended for use by the systems designer.

2.2 OPERATION - MODEL 76S

The 76S consists of a Diskette Drive Mechanism, Head Positioning Mechanism, Head Load Actuator and Read/Write Head, Safety Control, Interface and Read/Write electronics (see Block Diagram, Figure 2).

2.2.1 Diskette Drive Mechanism

The diskette drive motor rotates the storage element spindle at 360 rpm through a belt drive system. A registration hub centered on the face of the spindle positions the diskette. A self aligning clutch that moves in conjunction with the door fixes the diskette to the registration spindle.

2.2.2 Head Positioning Mechanism

An electrical stepping motor and lead screw position the read/write head. The stepping motor rotates the lead screw clockwise or counterclockwise in increments, each increment moves the read/write head one track position. The host system provides the direction of movement and step pulses corresponding to the number of tracks to be traversed.

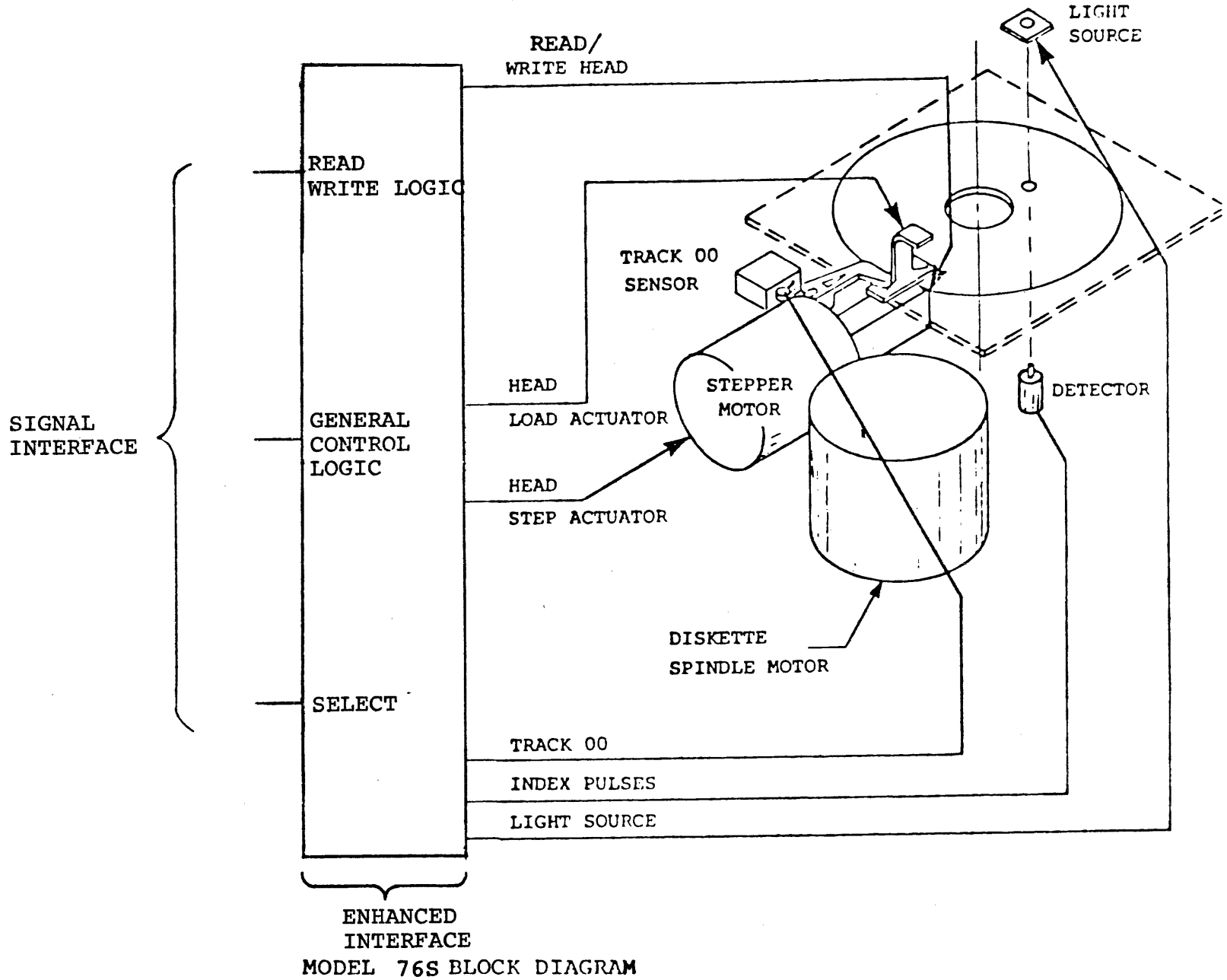

FIGURE 2

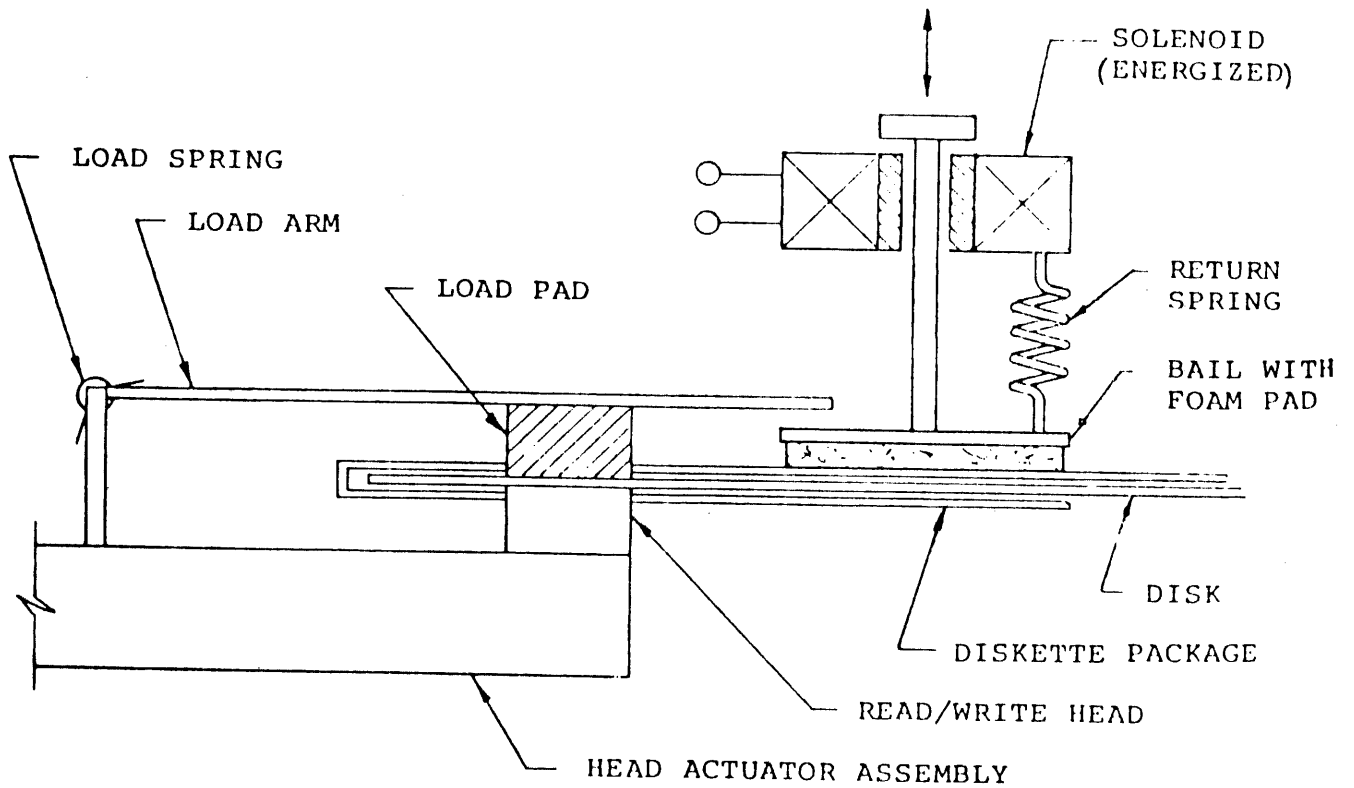

FIGURE 3

HEAD AND DISKETTE LOAD ACTUATOR ASSEMBLY

2.2.3 Head Load Actuator

The read/write head is mounted on a carriage which is driven by the track traversing lead screw. The diskette is precisely held in a plane perpendicular to the read/write by reference surfaces located on the base casting. The diskette is loaded in close proximity to the head with a load pad actuated by the head load solenoid (see Figure 3).

2.2.4 Control Electronics

The standard electronics are packaged on one printed wiring board. All input and output controls for reading and writing are generated or transmitted through this PWB. There are 8 input signals to the 76S including Drive Select (4), Direction Select, Step Write Gate, Write Data, and Load Head*. There are seven output signals from the 76S: Ready*, Index*, Track 00, Sector, Read Data, Separate Clock, and Separate Data (plus optional Write Protect).

2.2.5 Read/Write Head

The ORBIS Model 76S head comprises a single write/read gap followed by a tunnel erase structure whose function is to trim the inter-track spaces and eliminate signals in those regions. Thus, normal tolerance between media and drives will not degrade the signal-to-noise ratio and diskette interchangeability is insured. The ORBIS 76S read/write head with tunnel erase is designed to insure IBM compatibility.

2.2.6 Positive Operator Interlock

Two mechanical features are provided in the Model 76S Diskette Drive to protect the media and data base against loss. The first feature, the Operator Interlock, will not allow the clutch to engage the disk unless the diskette package is correctly positioned in the drive. This feature also gently ejects the diskette during unload.

The second feature protects the data written on the diskette against corruption by locking the front door closed during all read/write operations. Thus, the diskette can only be unloading when not in use.

*These signals are available on J5 for Enhanced Interface Operation.

3.0 INTERFACE DESCRIPTION - MODEL 76S

3.1 DAISY CHAIN INTERFACE

The signal and dc interface used by the Model 76S is of the "bus" or "daisy chain" type and allows an electrical hook-up as shown in Figure 4. Only one 76S is logically connected to the interface at any given time.

The maximum length of the daisy chain is twenty feet.*

The sole connector used for the interconnection is a 50-wire ribbon type. This, apart from taking minimum space, also provides the facility of requiring only one connector for each drive on the daisy chain.

Signals across the interface utilize standard TTL levels and are defined as follows:

Active	+0V to +0.4V
Inactive	+2.5V to +5.5V

The impedance of the signal lines (130 ohms) should be terminated at the receiving end by the network shown in Figure 4. This is achieved in the 76S itself by means of a plug-in terminating network which is inserted only into the drive which is physically connected to the end of the primary interface.

Addressing of the drive is determined by the address switches on the electronics board. This means that a drive's physical position on the interface does not determine its logical address.

Interface lines on the daisy chain are categorized into three types: Input Signals (to the 76S), Output Signals (from the 76S), and dc power (to the 76S).

* When daisy chaining SJ5 must be used to distribute dc power.

FIGURE 4

INTERFACE SIGNALS

HOST TO MODEL 76S SIGNALS

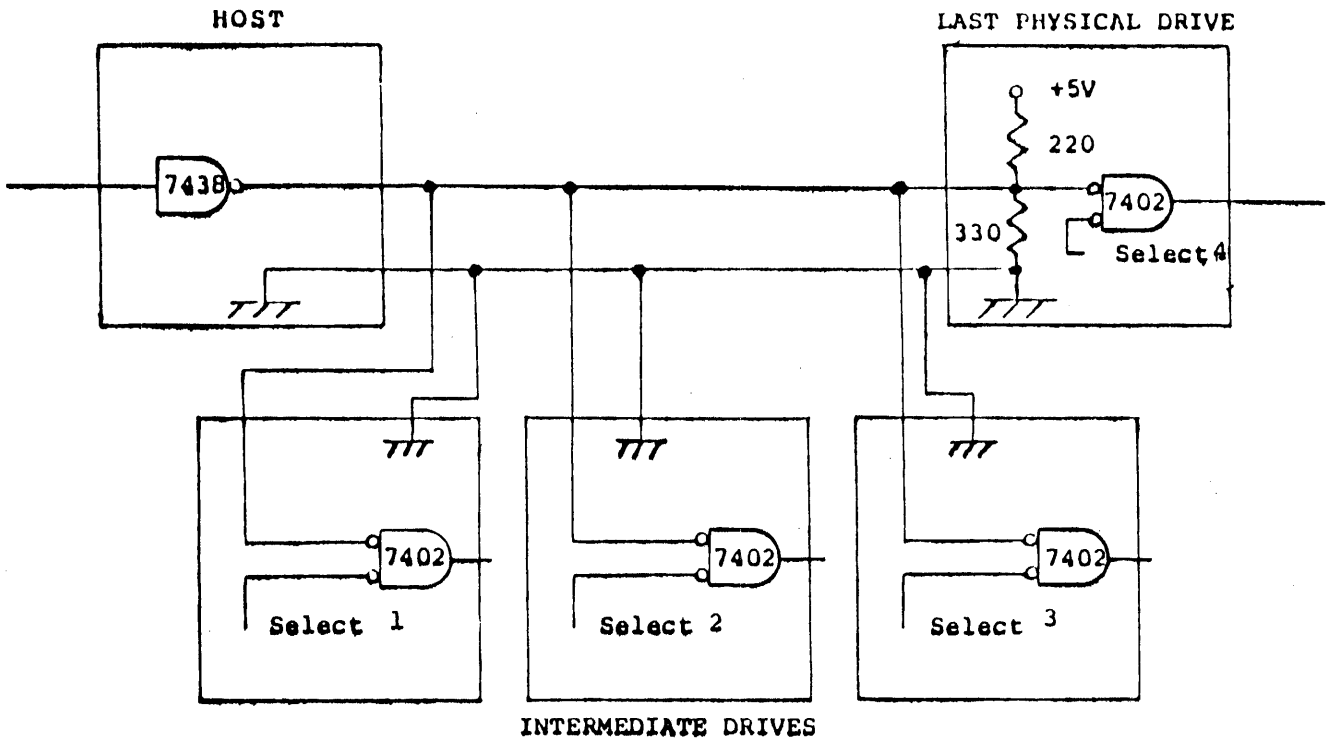

MODEL 76S TO HOST SIGNALS

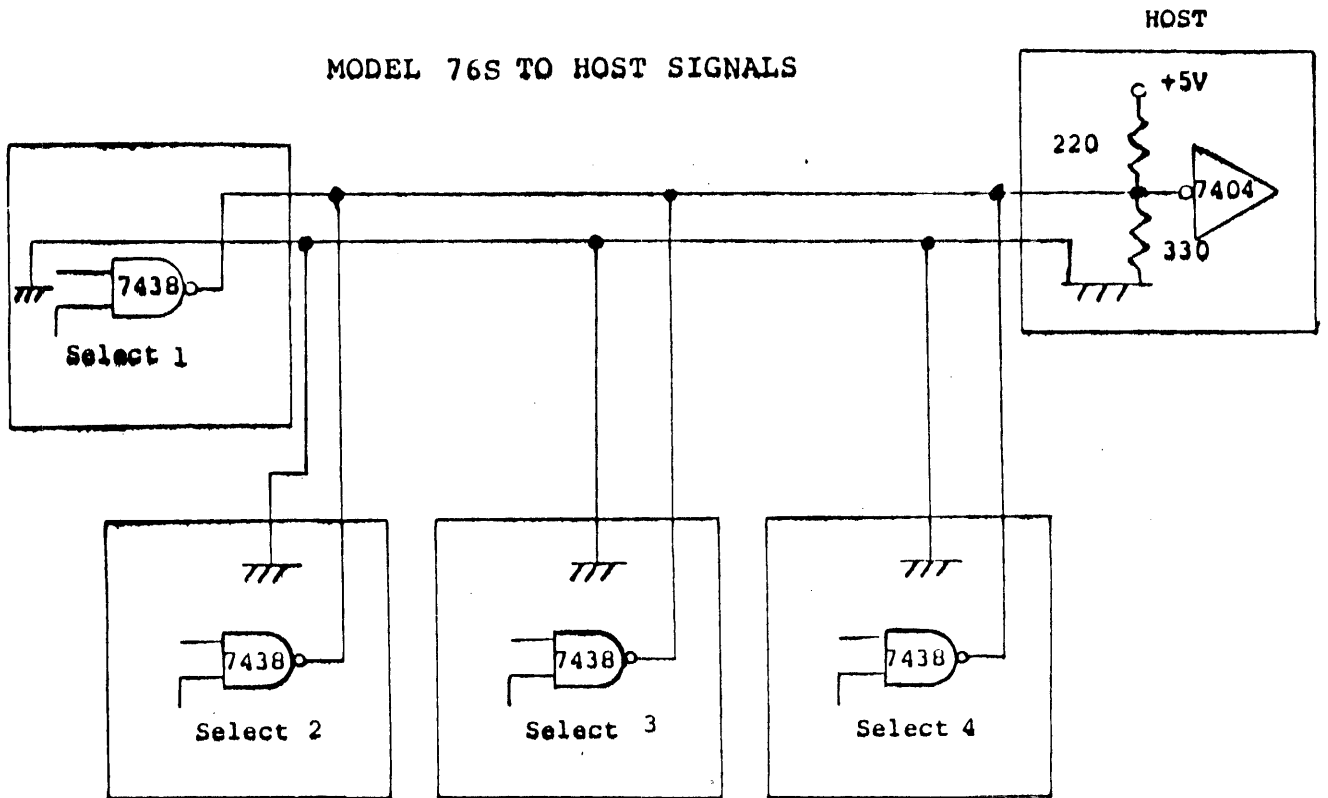

INTERFACE INTERCONNECT CIRCUIT SCHEME

3.2 INPUT LINES

There are ten (10) signal input line; eight (8) are standard and two (2) are user installable options (described later).

The input signals are of two types: those intended to be multiplexed in a multiple drive system and those which will perform the multiplexing. The input signals to be multiplexed are:

Direction Select

Step

Write Data

Write Gate

The input signals which are intended to do the multiplexing are:

Drive Select 1

Drive Select 2

Drive Select 3

Drive Select 4

The input lines have the following electrical specifications. Reference Figure 4 for the recommended circuit.

True = Logical zero = $V_{in} + 0.0V$ to $+0.4V$
@ $I_{in} = 40$ ma (max)

False = Logical one = $V_{in} + 2.5V$ to $+5.25V$
@ $I_{in} = 0$ ma (open)

3.2.1 Input Line Termination (Socket RN2)

The ORBIS 76S has been provided with the capability of terminating the input lines. This is accomplished by installing the input termination (RN2) in the socket in location 6A on the PWB of the last physical drive on a daisy chain.

3.2.2 Drive Select 1-4 (Pins 26,28,30 and 32 and Trace SI)

Drive Select when activated to a logical zero level, activates the multiplexed I/O lines and loads the R/W head. In this mode of operation only the drive with this line active will respond to the input lines and gate the output lines.

Four separate input lines, Drive Select 1, Drive Select 2, Drive Select 3 and Drive Select 4, are provided so that up to four drives may be multiplexed together in a system and have separate Drive Select lines. Traces "DS1", "DS2", "DS3", and "DS4" have been provided to select which Drive Select line will activate the interface signals for a unique drive. As shipped from the factory, a jumper from "S1" is installed on "DS1". To select another Drive Select line, this jumper should be moved to the appropriate "DS" pin. For additional methods of selecting drives, see section 7.

3.2.3 Direction Select (Pin 34)

This interface line is a control signal which defines direction of motion the R/W head will take when the Step line is pulsed. An open circuit or logical one defines the direction as "out" and if a pulse is applied to the Step line the R/W head will move away from the center of the disk. Conversely, if this input is shorted to ground or a logical zero level, the direction of motion is defined as "in" and if a pulse is applied to the step line, the R/W head will move towards the center of the disk.

3.2.4 Step (Pin 36)

This interface line is a control signal which causes the R/W head to move with the direction of motion as defined by the Direction Select line.

A low active transition (10 μ s minimum) on this line will cause the R/W head to move one track. The state of direction line is sampled 1 μ s after the leading edge of step pulse, thus allowing simultaneous transition of direction select and step lines. Refer to Figure 5 for the access timing relationships.

3.2.5 Write Gate (Pin 40)

The active state of this signal, or logical zero, enables Write Data to be written on the diskette. The inactive state, or logical one, enables the read data logic (Separated Data, Separated Clock, and Read Data). Refer to Figure 6 for timings.

3.2.6 Write Data (Pin 38)

This interface line provides the data to be written on the diskette. Each transition from a logical one level to a logical zero level will cause the current through the R/W head to be reversed, thereby writing a data bit. This line is enabled by Write Gate being active. Refer to Figure 6 for timings.

3.2.7 Head Load (Optional input trace HL)

This customer installable option, when activated to a logical zero level and the drive is READY AND SELECTED, will load the R/W head load pad against the diskette. Refer to section 7 for uses and method of installation.

3.2.8 Status Indicators (J2-31 through J2-34)

This option provides two front panel indicators for READY and SELECT. The indicators may be made to indicate the status of other terms. See section 7 for further details.

3.3 OUTPUT LINES

There are seven (7) output lines from the Model 76S. The output signals are driven with an open collector output stage capable of sinking a maximum of 40 ma at a logical zero level or true state with a maximum voltage of 0.4V measured at the driver. When the line driver is in a logical one or false state the driver is off and the collector current is a maximum of 250 microamperes. Refer to Figure 4 for the recommended circuit.

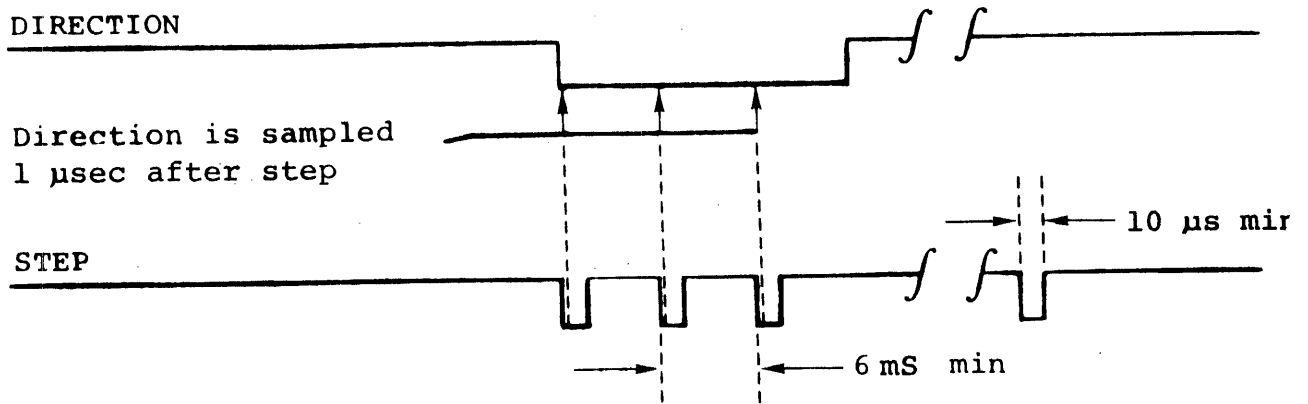

DIRECTION AND STEP TIMING

FIGURE 5

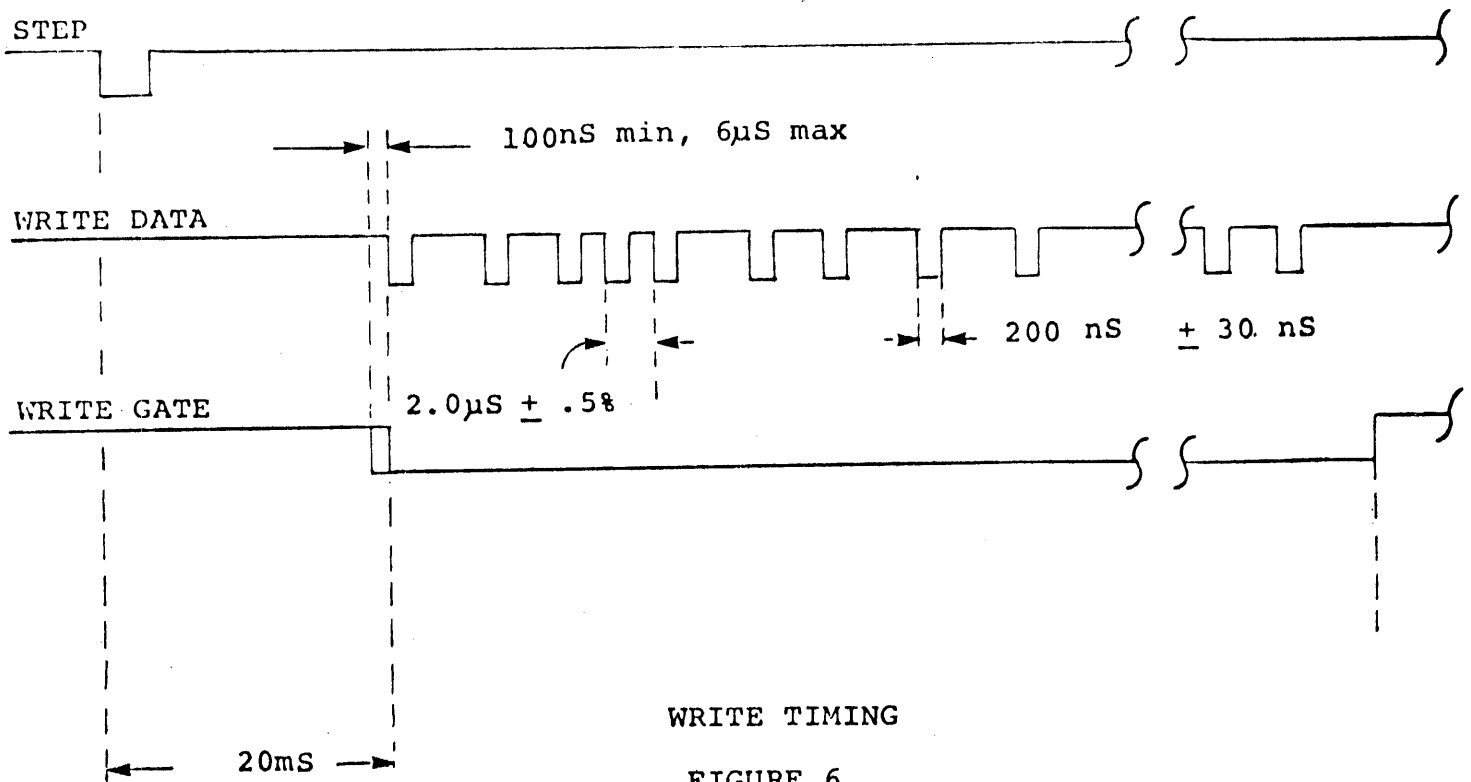

3.3.1 Track 00 (Pin 42)

A low active level on this line indicates that the read/write head of the selected drive is positioned at Track 00.

3.3.2 Index* (Pin 20)

This interface signal is provided by the selected diskette drive once each revolution (166.7ms) to indicate the beginning of the track. This signal makes a transition to a low active level for a period of $.45 \pm .2$ ms. The selected drive will always correctly output the index pulse. (Refer to Figure 7).

3.3.3 Sector* (Pin 24)

The index and sector are separated for a 33-hole media. Sector pulses are available on Pin 24 and Index on Pin 20. The Sector pulse width is 0.45 ± 0.2 ms. Figure 7 shows the timing of the SECTOR signal and its relationship to INDEX.

3.3.4 Ready* (Pin 22 and Traces R)

A low active level on this line indicates that a diskette is correctly loaded and rotating in the selected drive and that the front door is closed. A 1.3 second delay insures that the diskette has come up to speed.

3.3.5 Read Data (Pin 46)

Data from the selected drive is output to the host system in the same form as write data from the host system. Each flux reversal sensed on the storage element will result in a transition to a low active level for a 200 ns period on this line (See Figure 8).

3.3.6 Separate Data, Separate Clock (Pin 48, Pin 50)

This circuit splits the read data from the storage element into two categories: clock information (which appears on pin 50 of the interface SJ1) and "ones" data (which appears on pin 48 of the interface SJ1). The composite read data, as read from the

* These signals are also available on J5 continuously to provide for Enhanced Interface Operation. However, in the case of Index and Sector these signals are combined at the output.

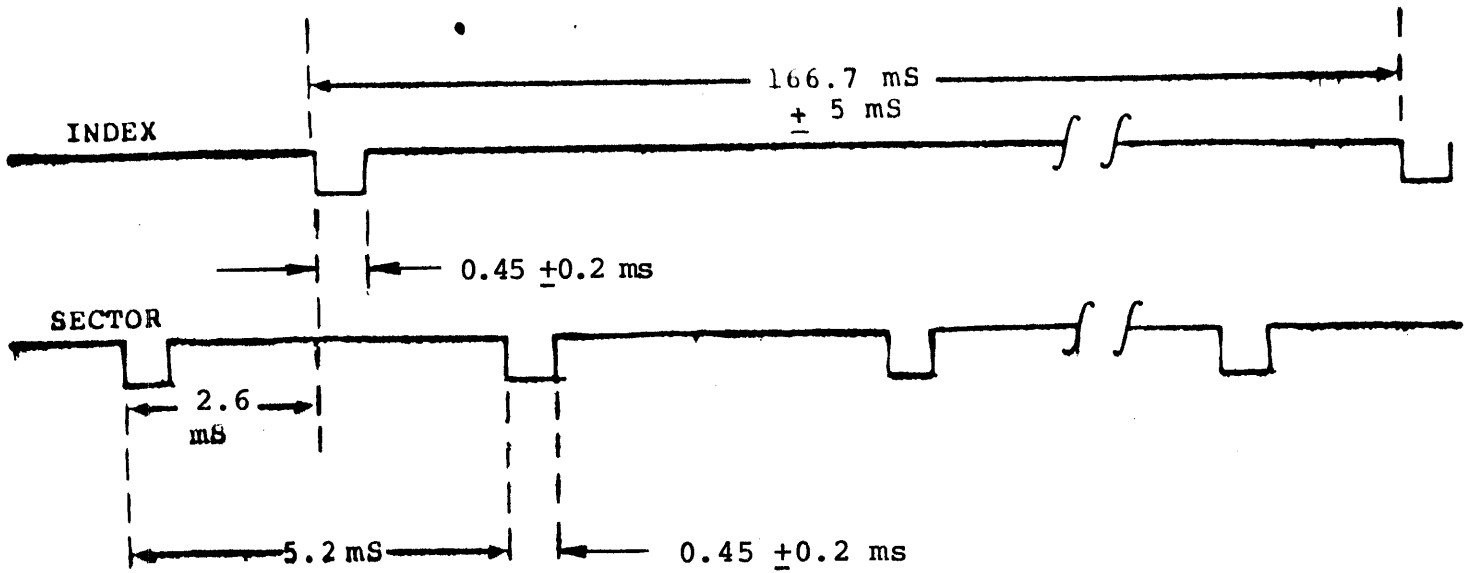

32 SECTOR/INDEX TIMING

FIGURE 7

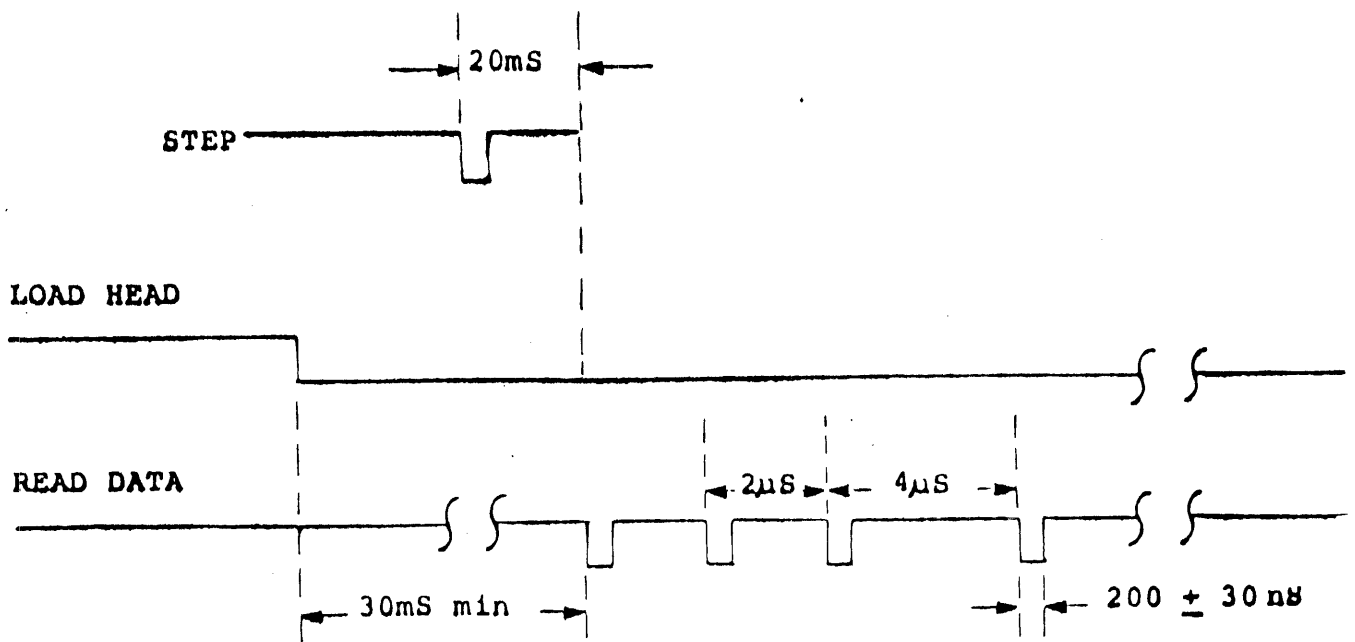

READ TIMING

FIGURE 8

diskette, is decoded and separated into two output lines called Separate Data and Separate Clock, as illustrated in Figure 9. The decoder automatically detects the clock pulses from the composite data and logically connects these to the Separate Clock line.

Special provision has been made to detect up to three missing clocks used in IBM sync codes. This simplifies the controller design. After pre-amble detection, normally a few bytes of "0", the user's system needs only to detect the missing clocks on the Separate Clock line to sync up.

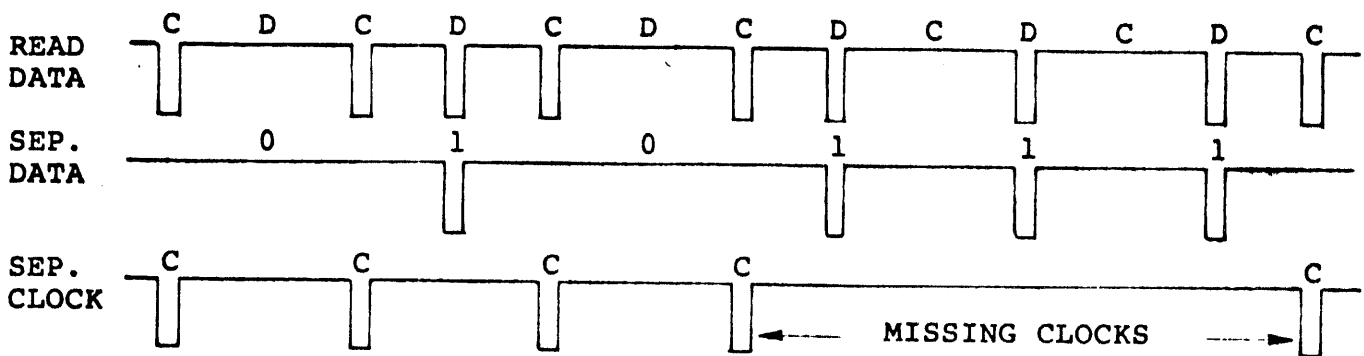

READ DATA

FIGURE 9

3.3.7 Write Protect (Optional Feature)

This interface signal is provided by the drive to give the user an indication when a Write Protected Diskette is installed. The signal is logical zero level when it is protected. Under normal operation the drive will inhibit writing with a protected diskette installed in addition to notifying the interface.

For other methods of using Write Protect, refer to Section 7.

3.4 ENHANCED INTERFACE

The Model 76S interface is designed to be as flexible as possible and from this point of view has been designed to allow for daisy chain operations. For maximum performance for a multiple Model 76S system a star connection is normally preferred. However, in order to achieve many of the characteristics of the star system and yet maintain by and large a daisy chain system structure, four signals are supplied on a separate connector (J5). These signals are Index/Sector, Head Load, Ready, and stepper power control; they are also available to alternate I/O pins.

With certain hard sectored formats and multiple drives it is necessary to keep track of the sector count (rotational position sensing - RPS) at all times even though no transfers are taking place. If this is not done, then the average latency time per record is increased to one full revolution which can have a significant effect on throughput. A basic daisy chain operation precludes RPS and, in order to provide this facility, optional signals resulting from physical holes on the medium (whether they represent index holes or sector holes) are made available continuously.

In the event that a significant amount of drive switching and transfers are required (for instance, in an "update and copy" operation) to wait until the selected drive has time to load its head is wasteful. By providing Head Load separately, this overhead time can be eliminated, and yet the head can be unloaded appropriately to increase media life further.

A fourth signal, Stepper Power Control, is optionally available at J5 to reduce power consumption of the 24-volt power supply. By its use DC power to the stepper circuit may be controlled externally. Power must be left on for a minimum of 20 ms after the last step command to ensure proper head positioning. Normally, Stepper Power Control is tied to Ready on the PWB.

The functions described above are available for connection to the alternate I/O pins via customer installed jumpers. Designations for these functions are as follows:

<u>Trace</u>	<u>Function</u>	<u>J5 Pin No.</u>
RR	Enhanced (Radial) Ready	1
RI	(Radial) Index/Sector Enhanced	3
RHL	(Radial) Head Load Enhanced	5
SP	Stepper Power Control	7

If specified by a customer, the factory will connect Stepper Power Control to operate in any one of the modes specified in Section 7.

3.5 ALTERNATE I/O

These interface pins have been provided for use with customer installable options. Refer to section 7 for methods of use.

3.6 POWER INTERFACE

The drive requires both ac and dc power for operation. The ac power is used for the spindle drive motor and the dc power is used for the electronics and the stepper motor.

3.6.1 AC power

The ac power to the drive is via the connector J8 located to the rear of the drive and adjacent to the ac motor. The J8 pin designations are outlined below for standard as well as optional ac power.

P8 PIN	60 Hz		50 Hz	
	110 V (Standard)	208/230 V	110 V	220 V
1	90-127 VAC	187-253 VAC	90-127 VAC	187-253 VAC
2	Frame Gnd	Frame Gnd	Frame Gnd	Frame Gnd
3	90-127 V Rtn	187-253 V Rtn	90-127 V Rtn	187-253 V Rtn
MAX CURRENT	0.5 Amps	0.3 Amps	0.6 Amps	0.4 Amps
FREQ TOLER- ANCE	± 0.5 Hz		± 0.5 Hz	

3.6.2 DC Power

DC power to the drive is via connector SJ5 located on component side of PWB adjacent to the motor pulley. The two dc voltages and their specifications along with their P5 pin designators are outlined below.

P5 PIN	DC VOLTAGE	TOLERANCE	CURRENT	MAX RIPPLE (p to p)
1	+24 VDC	± 2.4 VDC	1.2 A Max* 0.9 A Typ	25 mv
2	+24 V Return			
3	NOT USED			
4	NOT USED			
5	+ 5 VDC	± 0.25 VDC	1.0 A Max 0.8 A Typ	5 mv
6	+ 5 V Return**			

* By using stepper power control line the current requirements in daisy chain can be reduced to 0.1 A in the unselected drives.

** +5V Return is connected to logic ground (0V) and to +24V Return on the PWB.

4.0 MODES OF OPERATION

4.1 INTRODUCTION

The Model 76S operated in five modes. They are:

Power Up Mode	- Sequence after power is applied
Seek Mode	- Position read/write head to desired track
Write Mode	- Record data onto storage element
Read Mode	- Retrieve data from storage element
Power Down Mode	- Sequence as power goes down

4.2 POWER UP MODE

Applying ac and dc power to the drive can be done in any sequence; however, once ac power has been applied, a two second delay must be allowed before any Read or Write operation is attempted. This delay is for stabilization of the diskette rotational speed. When dc power is applied a 10 msec power on reset automatically resets the electronics and inhibits inadvertent writing or erasing on the diskettes. Thus, the drive is ready for operation two seconds after application of ac power and 20 msec after application of dc power. Also, initial position of the R/W head with respect to data tracks is indeterminate immediately after application of dc power. In order to assure proper positioning of the R/W head prior to any read/write operation, a Step Out operation for each drive should be performed until the Track 00 indicator becomes active.

4.3 DRIVE SELECTION

Drive selection occurs when a drive's Drive Select line is activated. Only the drive with this line active will respond to input lines. Under normal operation, the Drive Select line will load the R/W head, enable the input lines and activate the output lines. Optional modes of operation are available to the user by cutting or connecting traces. Reference section 7 for these user installable features.

4.4 SEEK MODE

The Seek Mode positions the read/write head to the desired track for recording or retrieving data. Seeking is accomplished by activating the interface Direction line appropriately and pulsing the interface Step line once for each track to be traversed. See Figure 5 for track seek timing. Seeking should not take place while writing.

4.5 WRITE MODE

The Write Mode records data on the storage element in the form of flux reversals. In order to record data onto the storage element, certain timing relationships must be assured. These relationships are required to avoid erasure of data due to hardware failure, head position not stabilized, or improper write current (see Figure 6).

4.6 READ MODE

The Read Mode retrieves data previously recorded on the storage element. This is accomplished by the read winding sensing flux reversals on the diskette. The Read Mode is entered if a diskette is present and the door is closed and by deactivating the Write Gate line. Certain timing relationships are required to assure that the read/write head has stabilized. These timing relationships are defined by Figure 8.

4.7 POWER DOWN MODE

During dc power down, when +5 volts drops below +3.7 volts, all write circuitry is deactivated to prevent inadvertent writing or erasing on the diskettes.

5.0 PHYSICAL INTERFACE

5.1 GENERAL

The basic signal, dc and ac interfaces between the Model 76S and host system are shown in Figure 11 and the physical dimensions of the drive are given in Figure 12. Two alternative and enhancement connectors are also supplied.

5.2 PRIMARY SIGNAL INTERFACE CONNECTOR (SJ1)

Connection to SJ1 is through a 50 pin PCB edge card connector. The dimensions for this connector are shown below. The pins are numbered 1 through 50 with the even numbered pins on the component side of the PCB and the odd numbered pins on the non-component side. Pin 2 is located on the end of the PCB connector closest to the ac spindle motor and is labeled 2. A key slot is provided between pins 4 and 6 for optional connector keying.

Figure 13 shows the interface connection pin assignments. The recommended connectors for P1 are tabulated below.

TYPE OF CABLE	MANUFACTURER	CONNECTOR P/N	CONTACT P/N
Twisted pair, #26 (crimp or solder)	AMP	1-583717-1	583616-5 (crimp) 583854-3 (solder)
Twisted pair, #26 (solder term.)	VIKING	3VH25/1JN-5	NA
Flat Cable	3M "Scotchflex"	3415-0001	NA

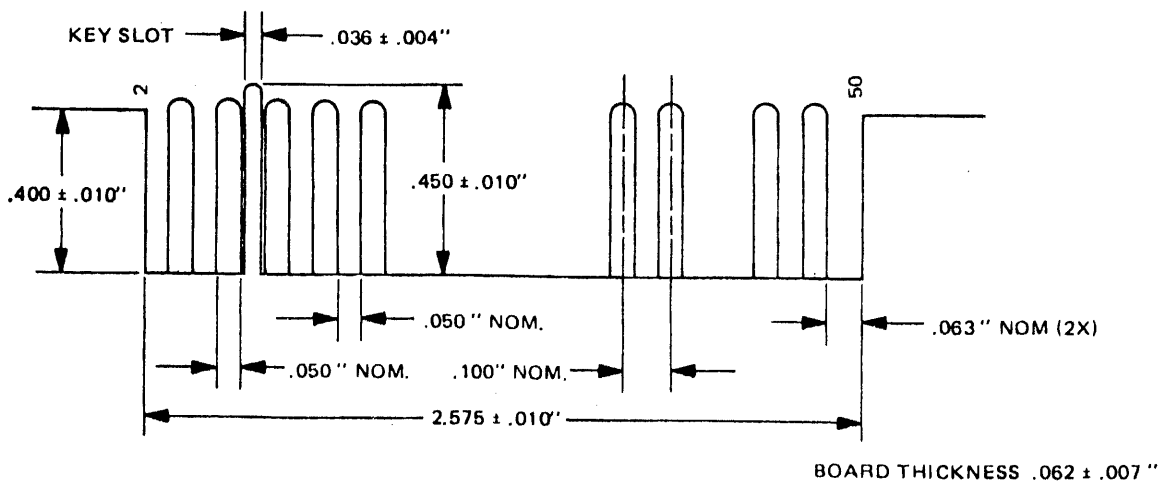
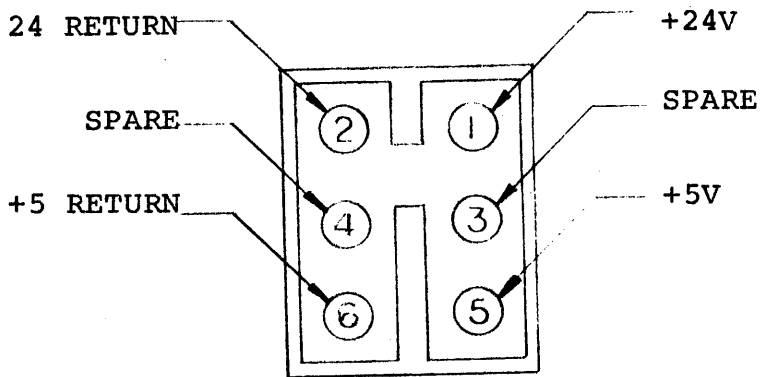
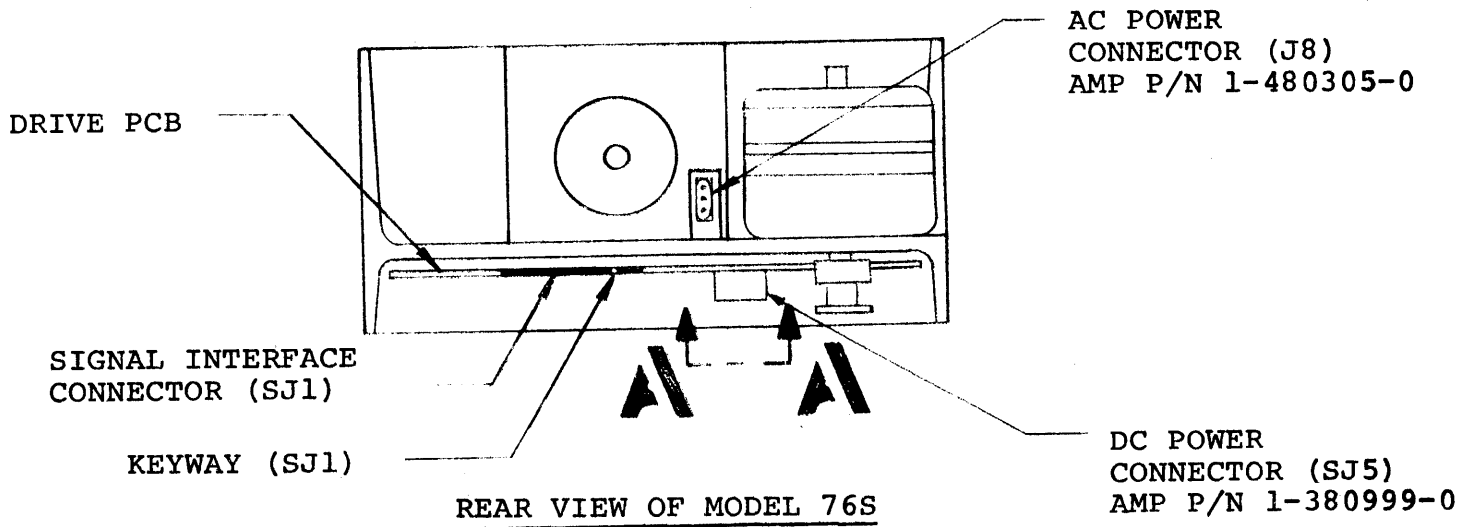

FIGURE 10

SJ1 CONNECTOR DIMENSIONS

FIGURE 11

INTERFACE CONNECTORS-PHYSICAL LOCATION DIAGRAM



VIEW



DC PWR CONNECTOR
(SJ5) REF

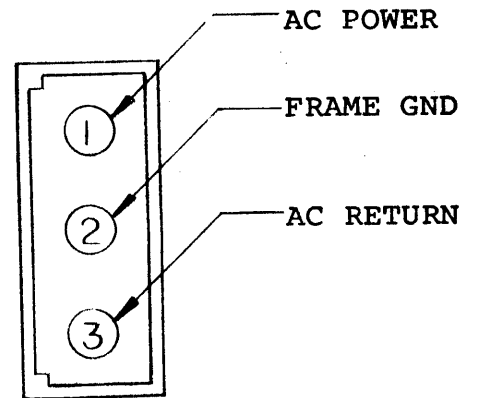

AC PWR CONNECTOR
(J8) REF



SIGNAL INTERFACE CONNECTOR
(P1)

FLAT CABLE: 3M P/N 3415-0001
TWISTED PAIR: AMP P/N 1-583717-1
VIKING P/N 3VH25/1JN-5

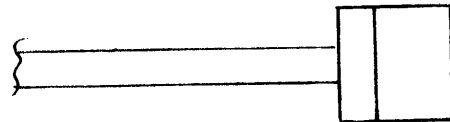

AC POWER CONNECTOR
(P8)

AMP P/N 1-480303-0
or
1-480304-0

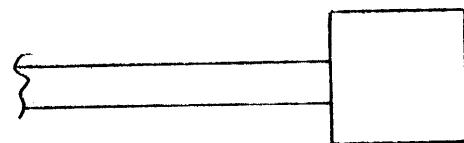

DC POWER CONNECTOR
(SP5)

AMP P/N 1-480270-0

MODEL 76S PHYSICAL DIMENSIONS

FIGURE 12

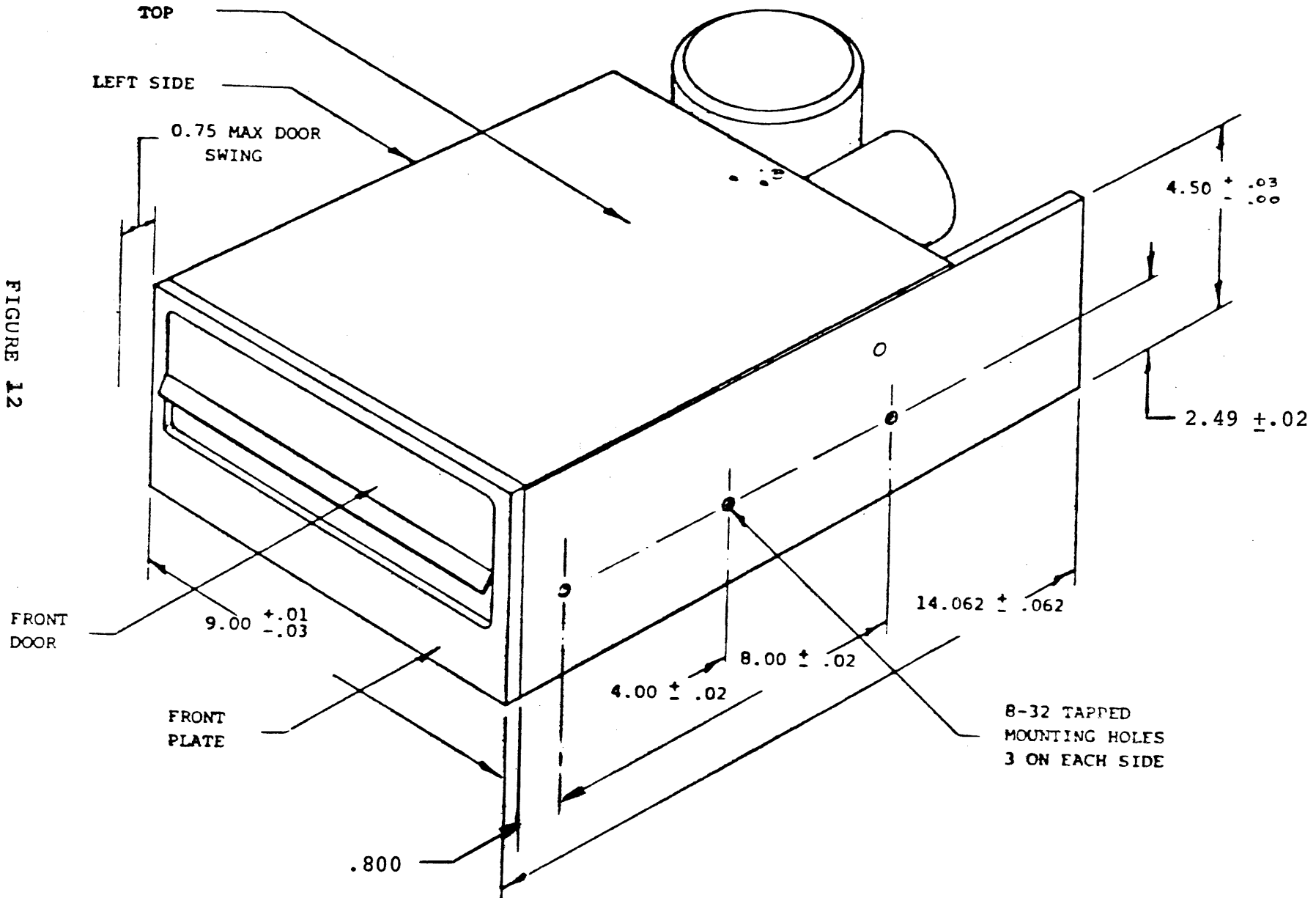

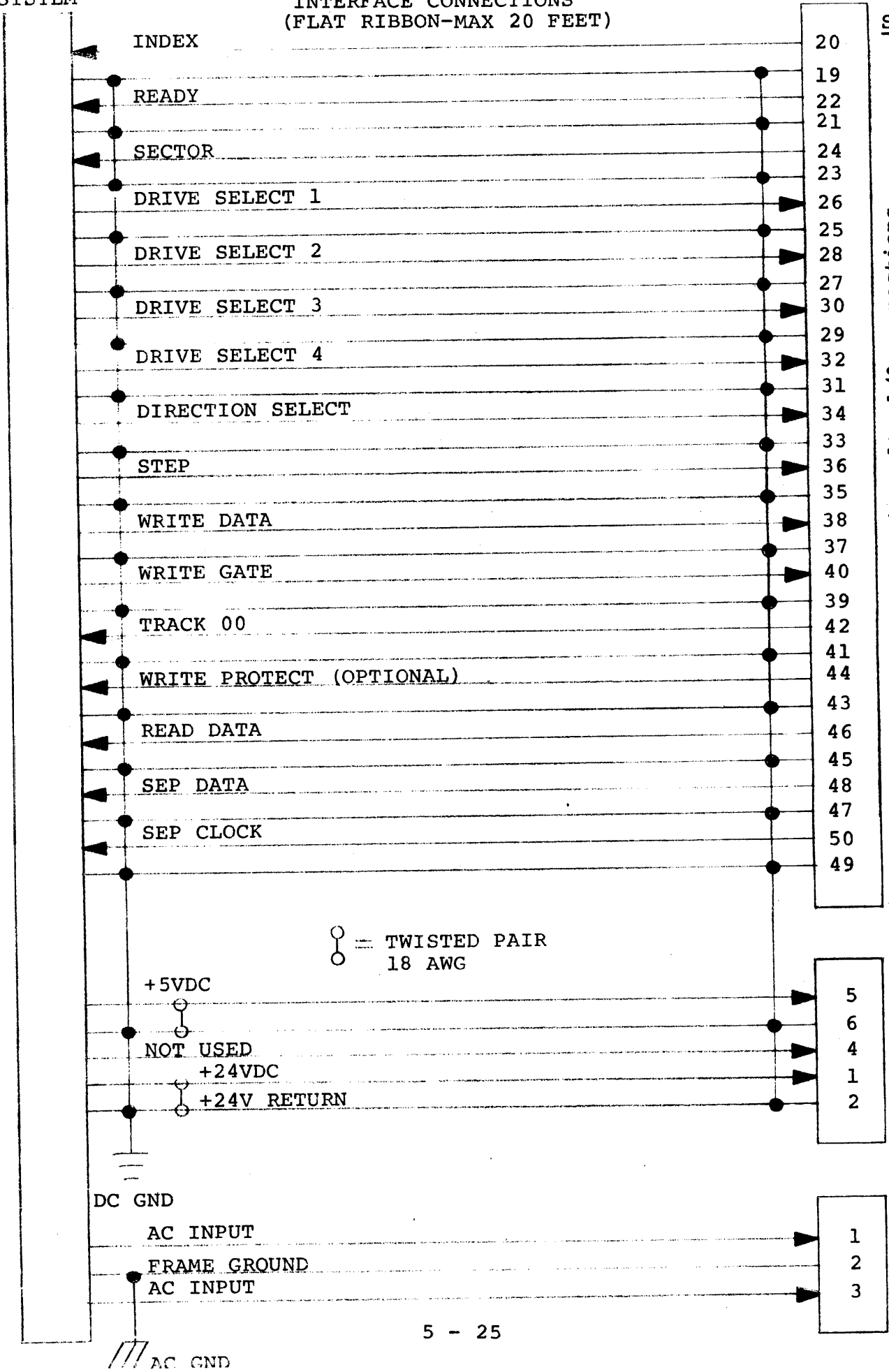

SJ1
NOTE: Not shown are the nine alt. I/O connections

SJ5

SJ8

5.3 DC POWER CONNECTOR (SJ5)

The dc power connector SJ5 is mounted on the component side of the PWB and is located next to the ac motor. SJ5 is a 6 pin AMP Mate-N-Lok connector P/N 1-380999-0. The recommended mating connector (P5) is AMP P/N 1-480270-0 utilizing AMP pins P/N 60619-1. J5 pins are labeled on J1/P1. Figure 14 illustrates J5 connector as seen on the drive PCB from component side.

SJ5 CONNECTOR

FIGURE 14

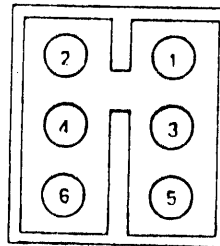

5.4 AC POWER CONNECTOR (J8)

The ac power connector J8 is mounted adjacent to the ac spindle motor at the rear of the drive. J8 connector is a 3 pin connector AMP P/N 1-480305-0 with pins P/N 60620-1. The recommended mating connector (P4) is AMP P/N 1-480303-0 or 1-480304-0, both utilizing pins P/N 60619-1. Figure 15 illustrates J8 connector as seen from the rear of the drive.

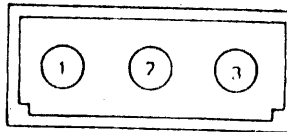

J8 AC POWER CONNECTOR

FIGURE 15

5.5 ENHANCED INTERFACE CONNECTOR (J5)

In order to provide for optional features another interface connector, J5, is provided. The function of the Enhanced Interface is described in section 3. Figure 16 shows the signal locations on J5. The connector which will mate with J5 is as follows:

Connector	- 1 ea	3M P/N 3421-3000
Cable	- A/R	3M P/N 3365-20
Key	- 1 ea	3M P/N 3535-0000

ORBIS Systems Inc. can supply these parts.

HOST SYSTEM	MODEL 76 S	J5
← READY		1
		2
← INDEX/SECTOR		3
		4
	→ HEAD LOAD	5
		6
	→ STEPPER POWER CONTROL	7
		8
		9
		10

ENHANCED INTERFACE PIN ASSIGNMENTS

FIGURE 16

6.0 ANCILLARY PRODUCTS

6.1 ORBIS 93 STORAGE ELEMENT

The ORBIS 93 Storage Element (see Figure 17) used in all ORBIS 76S Diskette Drives is a ferromagnetic coated flexible disk enclosed within a protective plastic jacket. The interior of the jacket is lined with a wiping material to clean the disk of contaminative matter. The storage element (diskette) is always kept in a storage and traveling envelope to further protect it from dust and contamination. The characteristics of the storage element are as follows:

Disk Diameter	- 7.875 inches
Envelope Size	- 8 inches x 8 inches

The diskette within the Model 76S has a rotational speed of 360 RPM + 3% with a rotational period of 166.67 ms + 5 ms and a bit density (inside track) of 3268 bpi. The ORBIS 93 Storage Element is IBM compatible and is equivalent to IBM Diskette Part Number 2305830.

6.2 ORBIS 94 STORAGE ELEMENT

ORBIS also provides 33-hole media (Model 94) for electronic hard sectoring and can provide media with the write protect notch in the jacket to allow the use of the optical write protect feature.

6.3 POWER SUPPLIES

Power supplies for the Model 76S are available from ORBIS for single and multiple diskette drive systems.

6.4 SYSTEMS

ORBIS offers a wide range of system products including:

1. Model 84 Formatter/Controller
2. Model 86 Double Density Encoder/Decoder
3. Multiple Drive Rack Mounting Systems

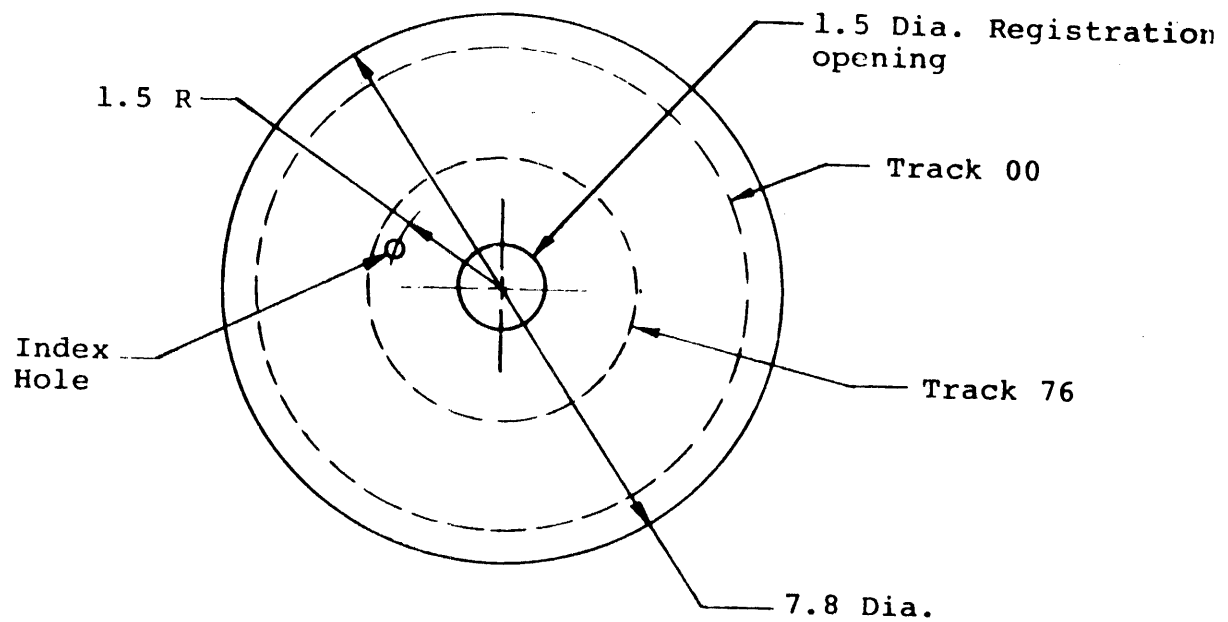
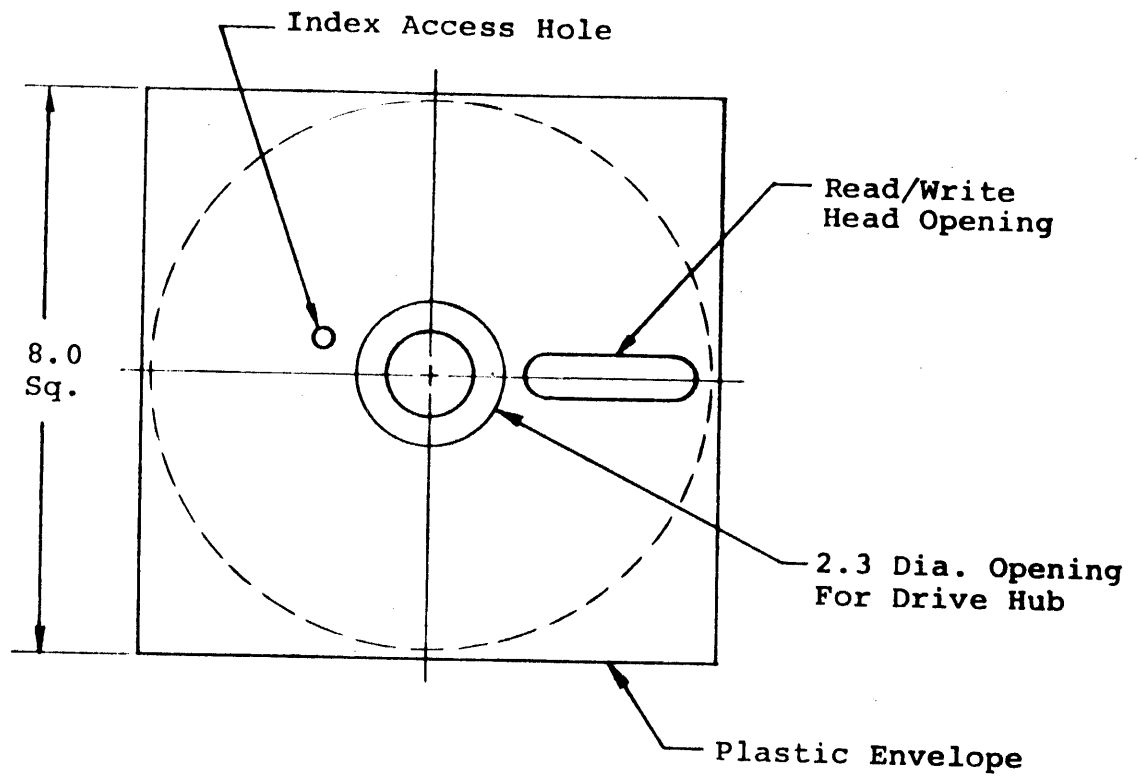

ORBIS 93 STORAGE ELEMENT PHYSICAL DIMENSIONS
 FIGURE 17

7.0 OPTIONS

7.1 CUSTOMER INSTALLABLE OPTIONS

The Model 76S can be modified by the user to function differently than the standard method as outlined in sections 4 and 5. These modifications can be implemented by adding or deleting traces and by use of the Alternate I/O pins. This section will discuss a few examples of modifications and how to install them. The examples are:

Select drive without loading head

Radial head load (load head without selecting drive)

Radial Ready

Radial index/sector

Drive select one to eight drives

Stepper power control option

- . enable power with head load
- . enable stepper power with Select Ready
- . enable stepper power with alternate I/O pin

File Unsafe logic

Option Connector J4

The standard drive configuration is listed in figure 18.

7.1.1 Select Drive Without Loading Head

This option is advantageous to the user, requiring the drive to be selected most of the time. Head is loaded via one of the alternate I/O lines only when Read or Write function is performed. After the Head Load line is activated a 30 ms delay is required before Write Gate and Write Data are applied or before Read Data is valid. See figure 19. This option extends the head and media life. To install the option on a standard drive the following should be added or deleted:

- a. Remove jumper from HL to S1
- b. Add a jumper from one of the alternate I/O pins to HL

TRACE DESIGNATOR	DESCRIPTION	SHIPPED FROM FACTORY	
		OPEN	SHORT
RN2-2	Terminator for multiplexed inputs	X	
RN2-1	Termination for drive select inputs	X	
S1	Select		DS1
HL	Head Load		S1
RHL	Radial Head Load	X	
RR	Radial Ready	X	
RI	Radial Index/Sector	X	
SP	Stepper Power from Radial Ready (RR)		X
S	Sectors 32		X
2,4,6,8, 10,12,14, 16,18	Nine alternate I/O pins	X	

Figure 18

Standard Drive Configuration

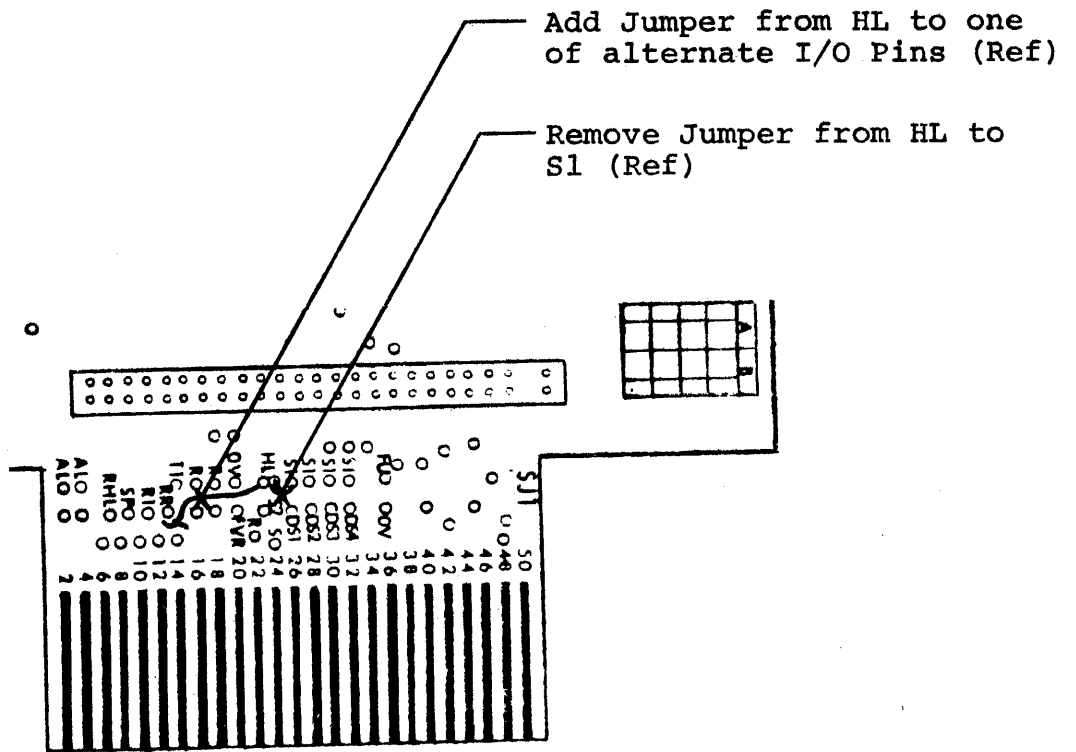

FIGURE 19

SELECT DRIVE WITHOUT H.L.

7.1.2 Radial Head Load

This option allows the head to be loaded without selecting the drive. It allows the user to keep the head loaded all the time like in diskette-to-diskette copy operation, which eliminates the 30 ms head load time. Alternate I/O pin is used for head load.

To install this option on a standard drive the following should be added. (See Figure 20)

- a. Connect a jumper from one of the alternate I/O pins (2,4,6,8,10,12,14,16,18) to pad RHL.

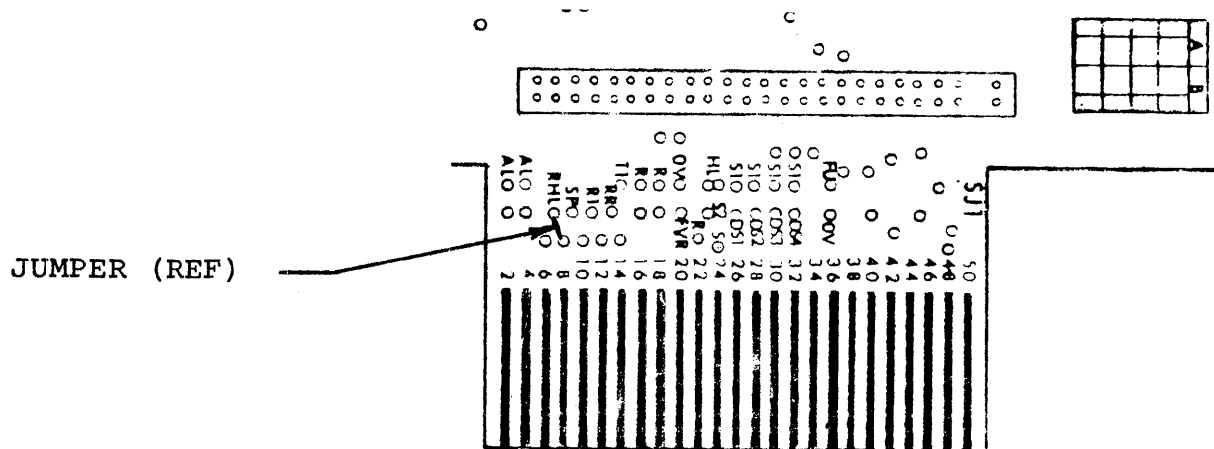

FIGURE 20

RADIAL HL OPTION

7.1.3 Radial Ready

This option allows user to monitor the Ready line on each drive interface. This is useful in detecting when an operator has removed or installed a diskette in any drive. The normal Ready line (SJ1-22) is added with Select function.

To install this on a standard drive the following should be added. (See Figure 21)

- a. Add a jumper from pad RR to one of the alternate I/O pins.

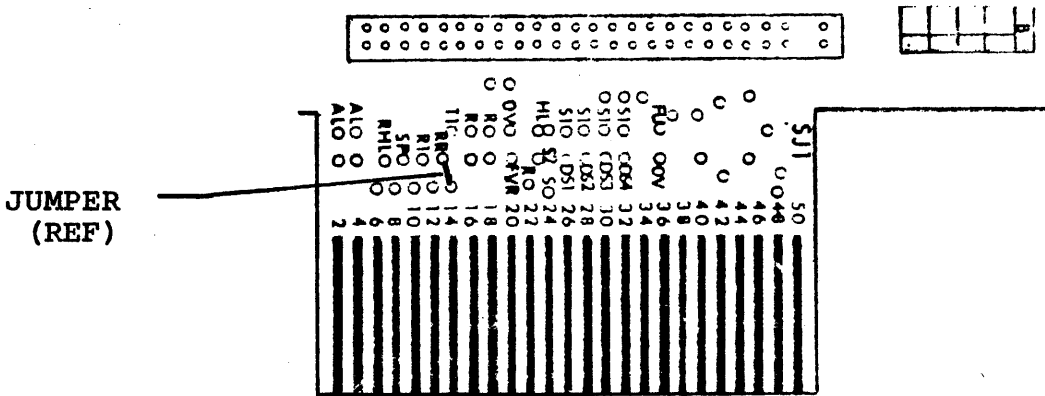

FIGURE 21

RADIAL READY OPTION

7.1.4 Radial Index/Sector

This option enables the user to monitor the Index and Sector lines at all times so that the drive may be selected just prior to the sector that is to be processed. This option can be used to reduce average latency.

To install this option on a standard drive the following should be added: (See Figure 22)

- a. Add a wire from track RI to one of the Alternate I/O pins.

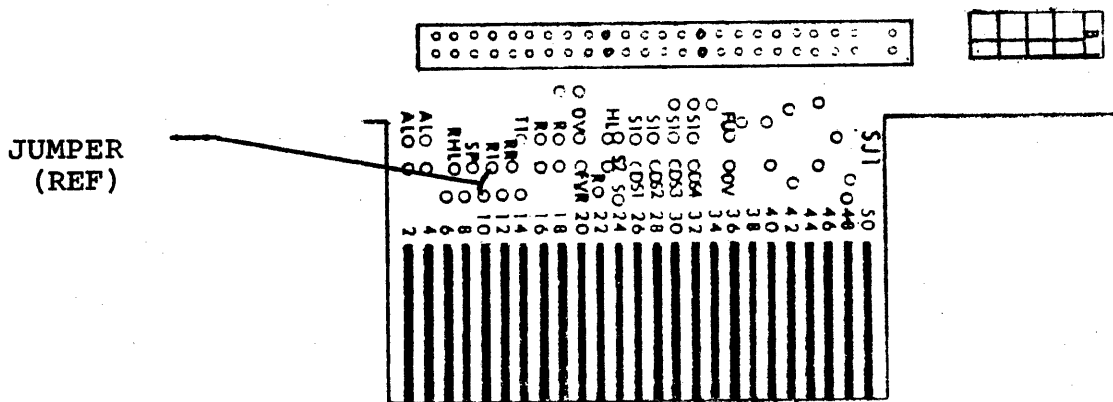

FIGURE 22

RADIAL INDEX/SECTOR OPTION

7.1.5 Drive Select - One to Eight Drives

This option enables the user to multiplex up to eight drives on the same daisy chain. One through 4 drives are selected by jumpering S1 to any of DS1, DS2, DS3, DS4 pins, the same as in a standard drive. An additional line, S2, connected to any one of the alternate I/O pins controls (binary) selection of either of the four-drive groups as given in the table below. An inactive "0" level on S2 selects the drives 0 through 3 and an active "1" level selects the drives 4 through 7, as outlined in the table below.

To install this option (no additional logic is required) on a standard drive, the following should be deleted or added: (See Figure 23)

- a. Add a jumper from S2 to one of the alternate I/O pins.
- b. For drive numbers 4 through 7:
 - . delete jumper from SW1-3 to 6
 - . add jumper from SW1-4 to 5

DRIVE SELECT 0 THROUGH 7

DRIVE NO.	S2	DS1	DS2	DS3	DS4
0	0	1	0	0	0
1	0	0	1	0	0
2	0	0	0	1	0
3	0	0	0	0	1
4	1	1	0	0	0
5	1	0	1	0	0
6	1	0	0	1	0
7	1	0	0	0	1
NONE	X	0	0	0	0

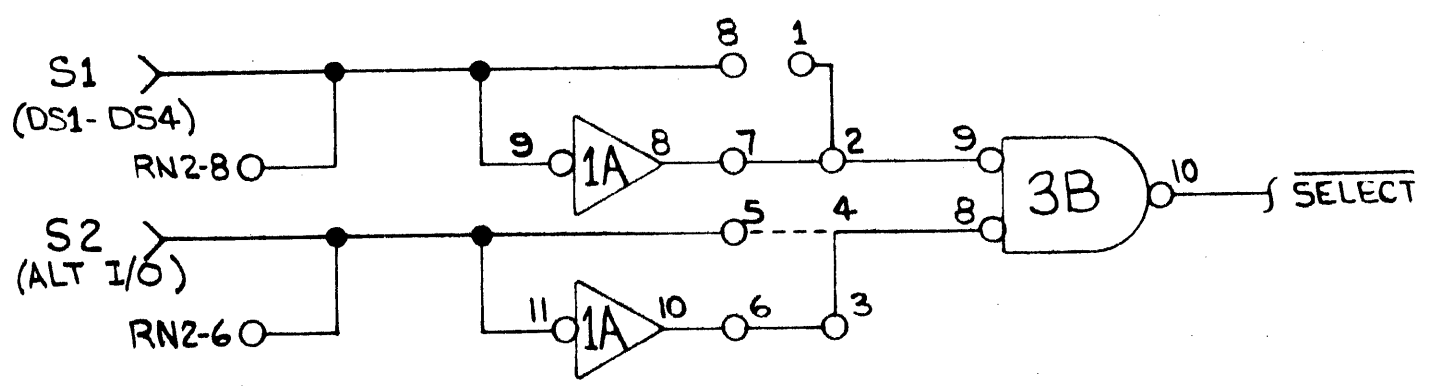
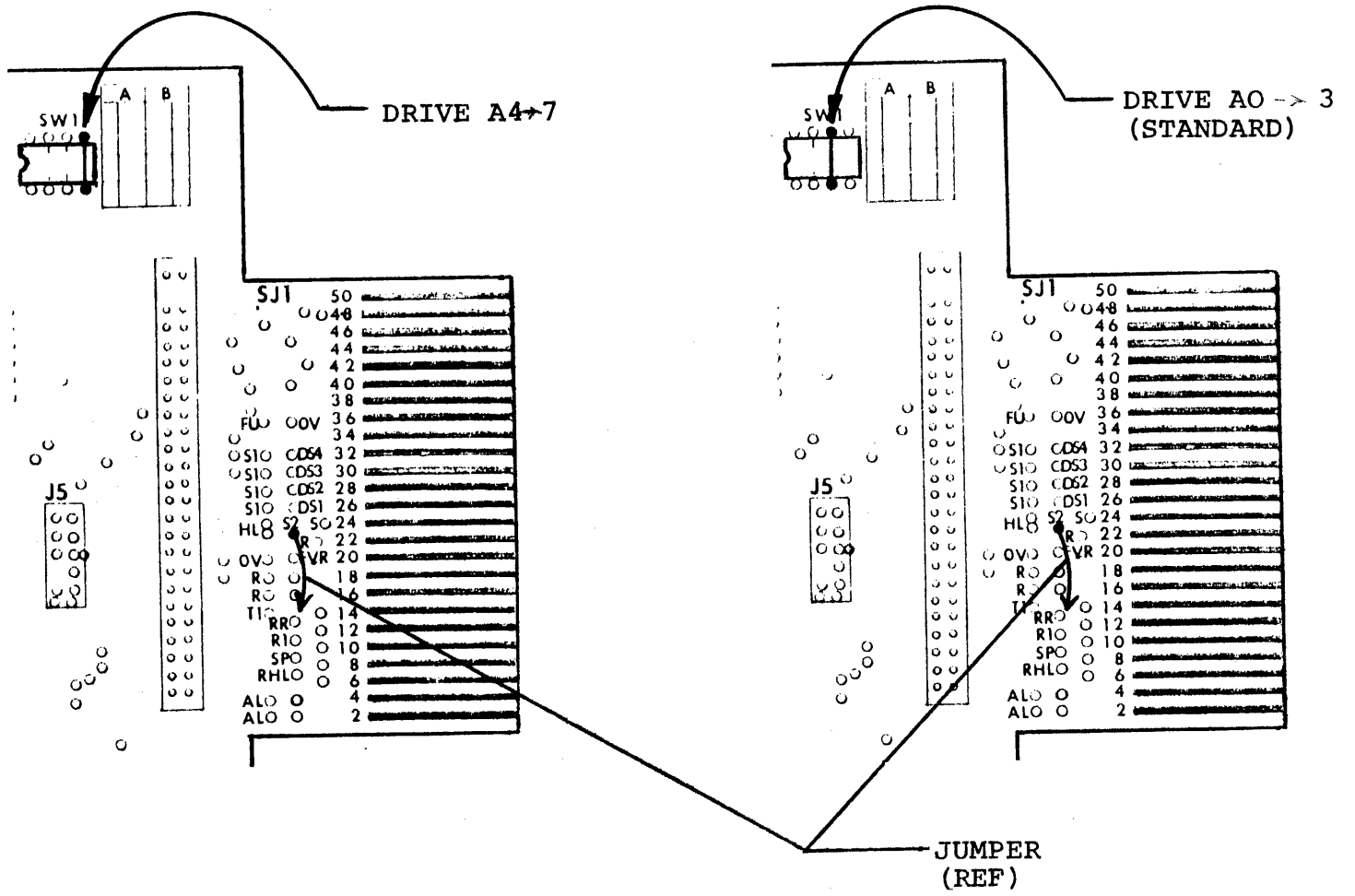

FIGURE 23

ONE OUT OF 8 DRIVE SELECTION OPTION

For Drive A0-3 use the standard drive (that is, leave the jumper at SW1-3 to 6). For Drive A4-7 delete jumper SW1-3 to 6 and add jumper SW1-4 to 5.

7.1.6 Stepper Power Control Option

This option enables the user to reduce dc power dissipation of +24V by 25 watts. The power to the stepper circuitry could be controlled by Head Load, Select or one of the alternate I/O pins. In standard drives the stepper power is controlled by Ready. Power must be left on for a minimum of 20 ms after the last step command to insure proper head positioning. The following options can be installed to save power dissipation:

a. Enable power with Head Load

To install this option on a standard drive, the following should be cut and added: (See Figure 24)

- i. Cut the Ready trace as shown on solder side.
- ii. Add a jumper from SP to IIL.

b. Enable power with Select

To install this option on a standard drive following should be cut and added: (See Figure 25)

- i. Cut the Ready trace as shown on solder side
- ii. Add a Jumper from SP to S1

c. Enable power with alternate I/O pin

To install this option on a standard drive the following should be cut and added: (See Figure 26)

- i. Cut the Ready trace as shown on solder side
- ii. Add a Jumper from SP to one of the alternate I/O pins

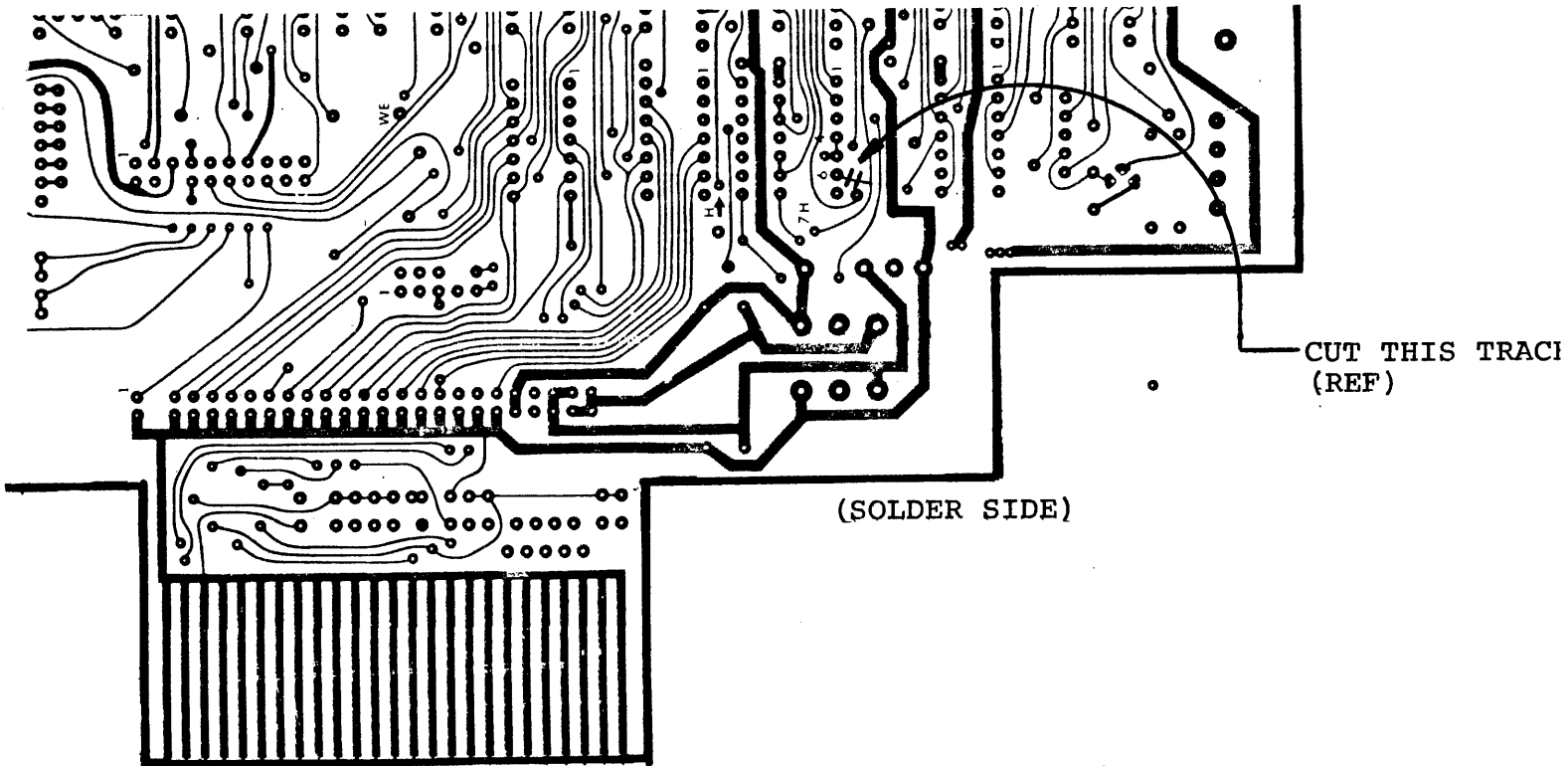
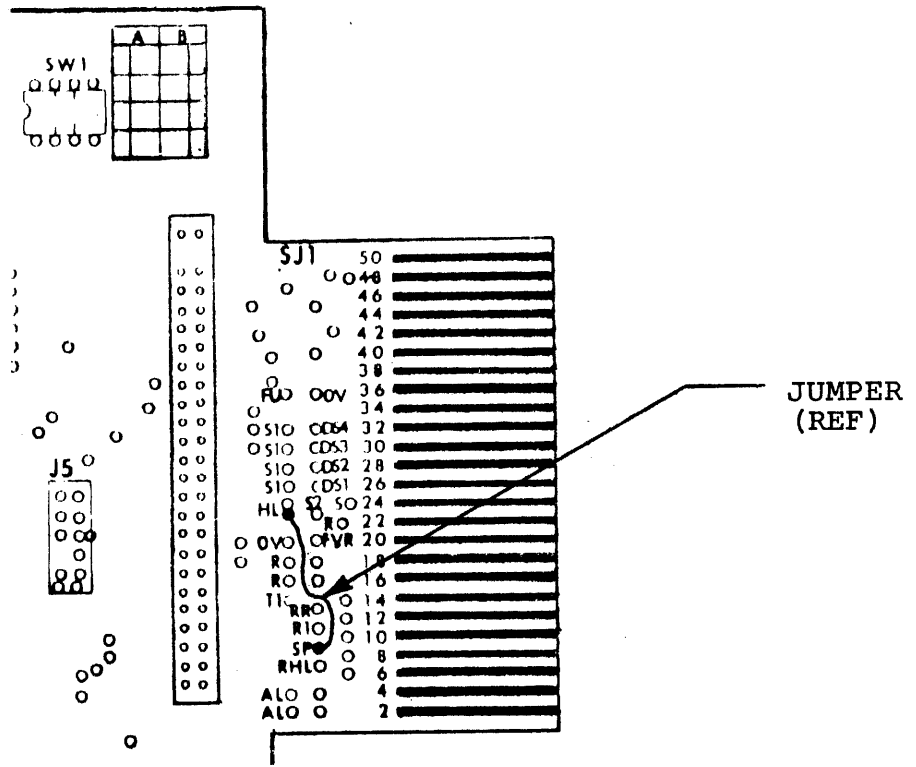

FIGURE 24

STEPPER POWER CONTROL WITH H.L. OPTION
7 - 38

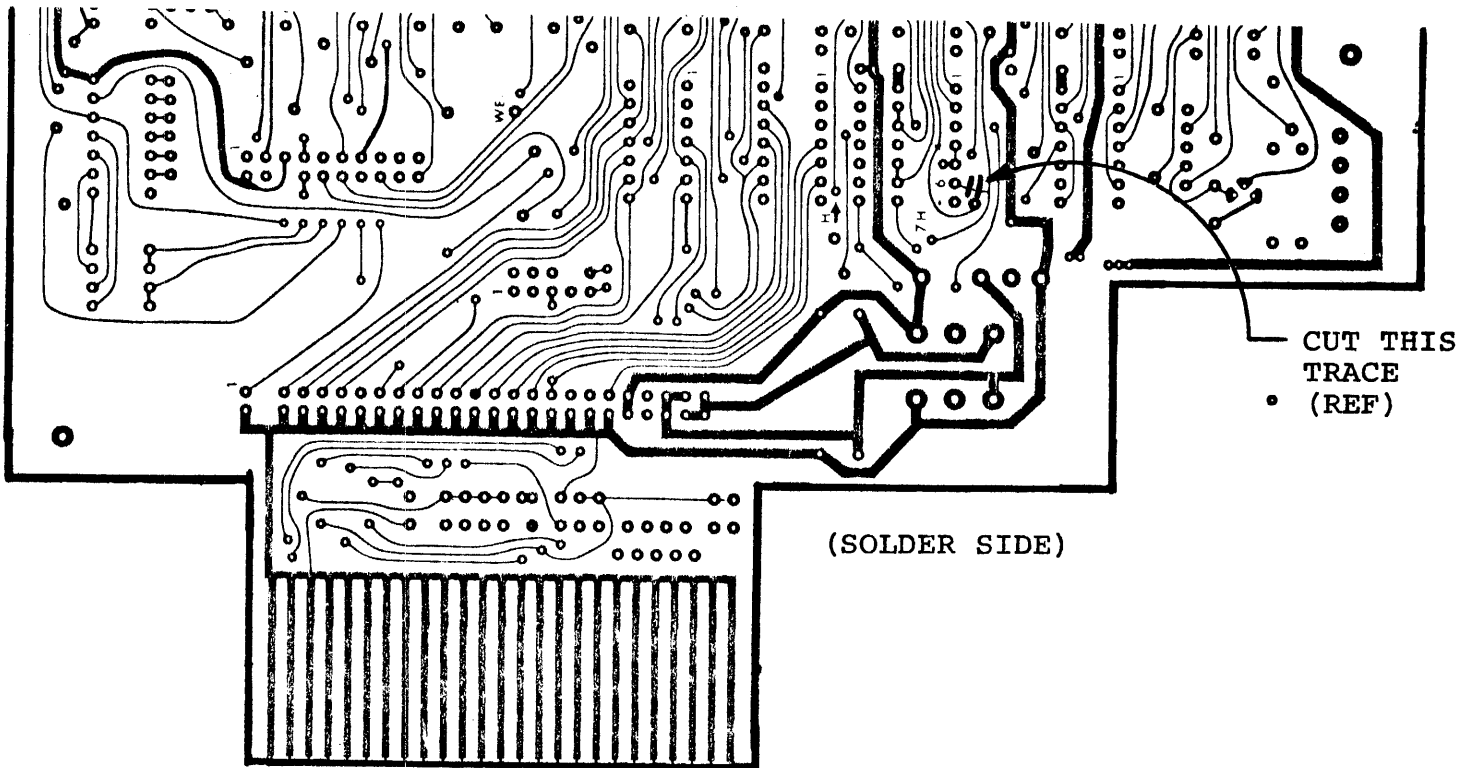
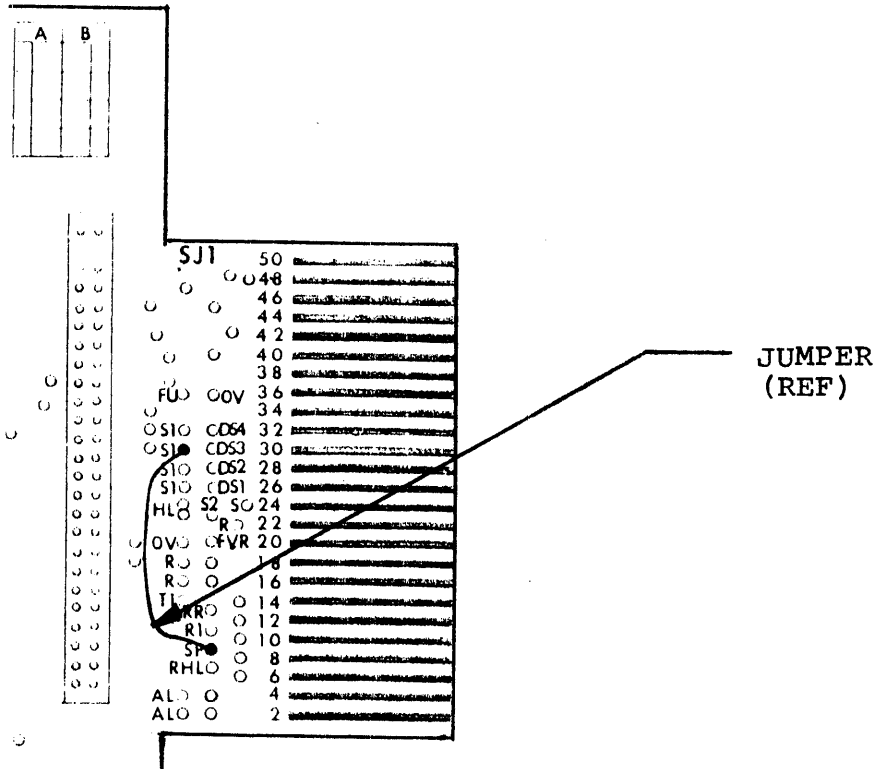

FIGURE 25

STEPPER POWER CONTROL WITH SELECT

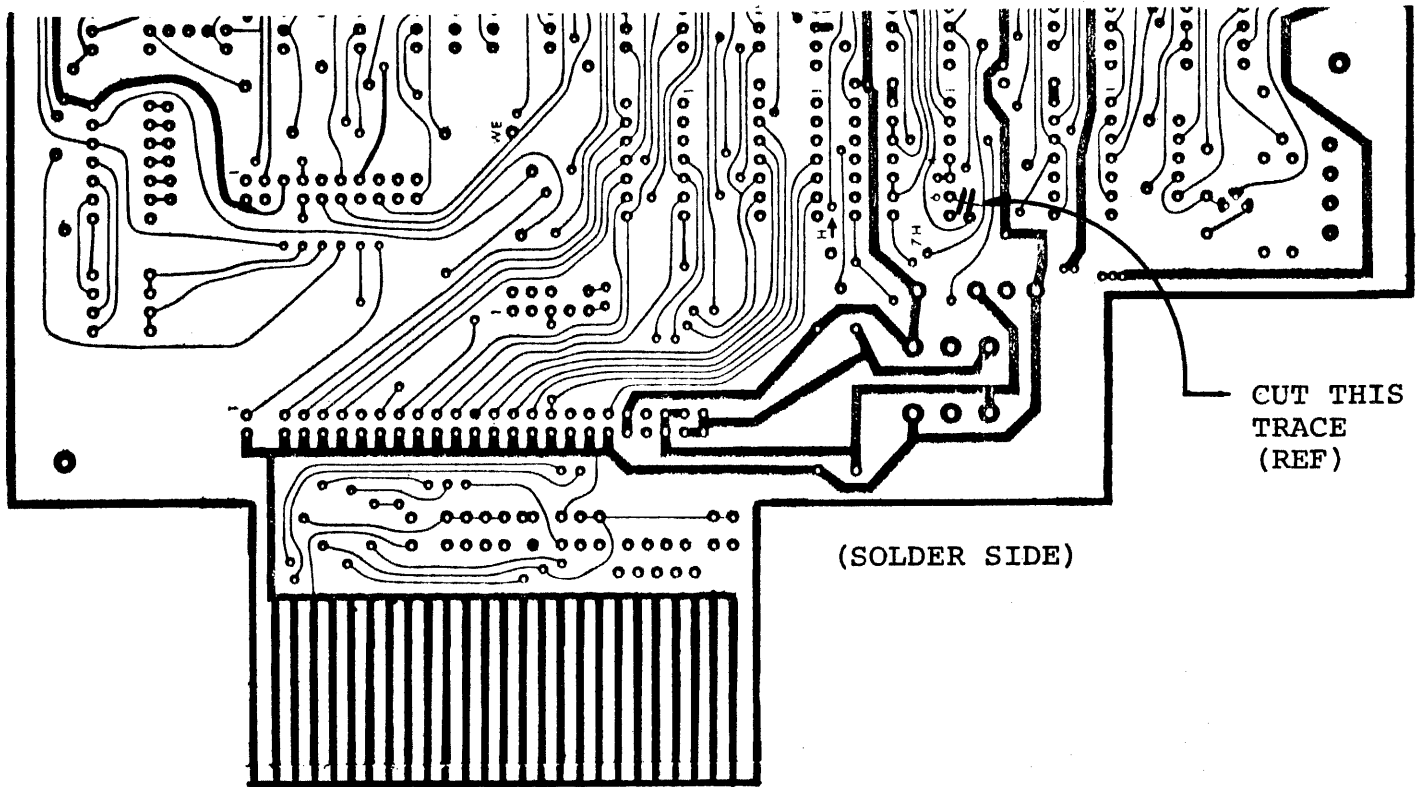
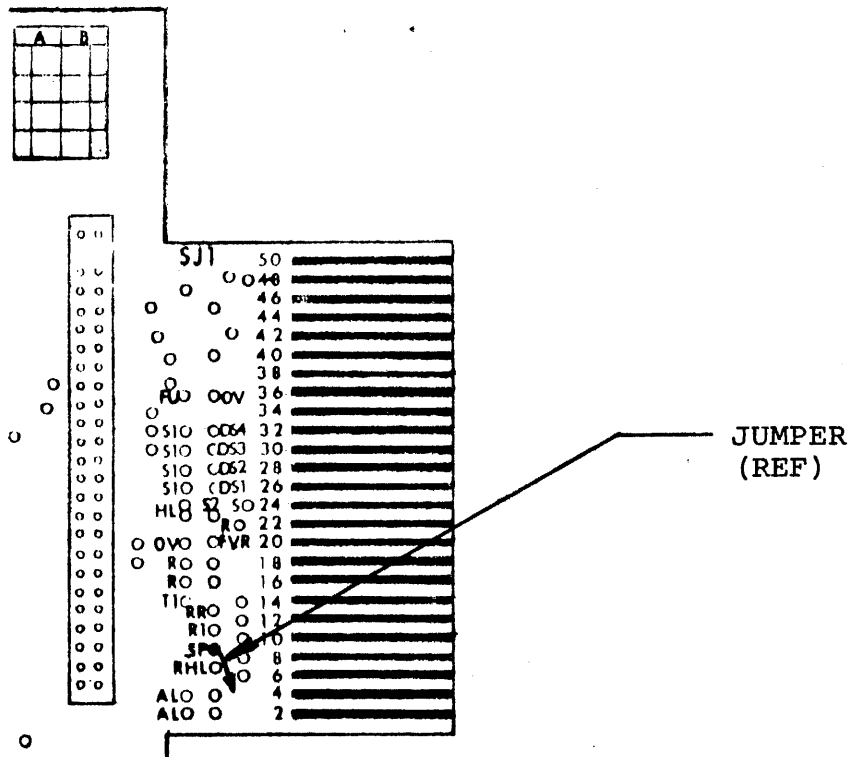

FIGURE 26

7.1.7 File Unsafe Logic

This option enables the user to detect the condition which may jeopardize data integrity on a selected drive has occurred. Write safety circuits insure that hardware failure or operator interference does not cause loss of data. If write safety circuit detects an unsafe condition within the drive, a latch is set, writing is inhibited and the host system could be notified by connecting the File Unsafe (F.U.) line to one of the alternate I/O pines. File Unsafe conditions are defined as follows:

- i. Write gate and no write data
- ii. Write gate and write protect (option)
- iii. Write gate and step
- iv. Write gate and head not loaded

Time delays are used to prevent setting of File Unsafe for normal timing relationship of the above signals (See Figure 6).

The File Unsafe Reset signal is used to clear an Unsafe Condition. A low active level (200 ns minimum) on this line (FUR) resets the selected File Unsafe latch, providing the capability of a write retry operation without operator intervention.

The logic for detecting file unsafe conditions is a part of the standard drive but is disabled and to install this option on a standard drive, delete or add the following: (See Figure 27)

- i. Remove jumper on component side.
- ii. Install jumper from F.U. to one of the alternate I/O pins
- iii. Install jumper from F.U.R. to one of the alternate I/O pins.

7.1.8 Option Board

This option enables the user to plug in an extra electronics board into the main PWB within the confines of the drive. Two holes are provided to mount the board to the main casting. DC voltages of +5V and +24V are available along with Index and Data signal as defined in the Table below. This extra logic add-on capability provides the user with a wide variety of options, such as:

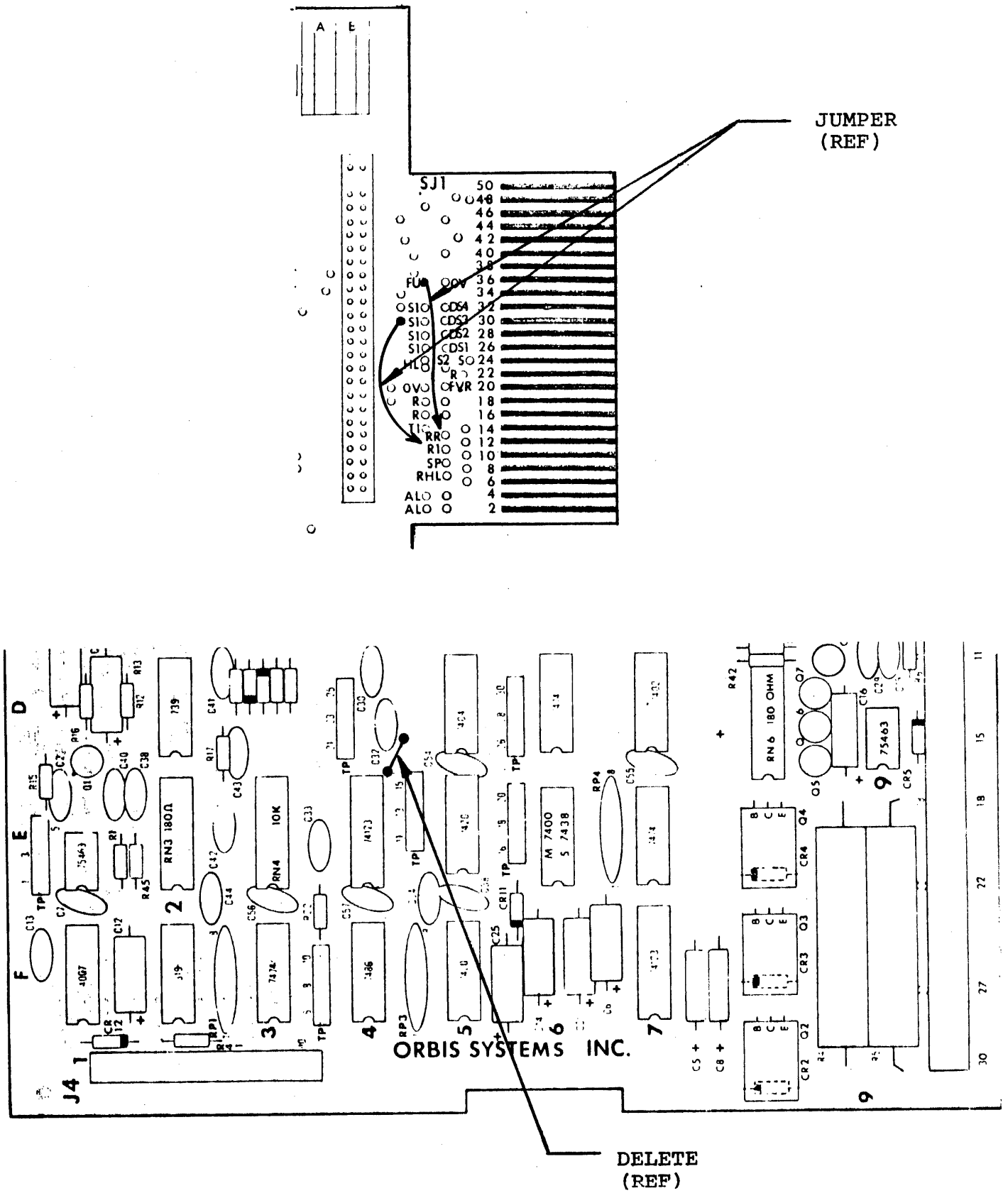

FIGURE 27

FILE UNSAFE LOGIC OPTION

- i. Index counting
- ii. Timing delays
- iii. Phase-locked loop for Read data separation
- iv. Data formatting and sync functions

A control line, D/C J4-6, disables the Read data decoder on the main pwb and enables two lines (J4-1,4 to SJ1-48,50 interface) for output to the host system.

OPTION PWB INTERFACE J4

PIN NO.	SIGNAL NAME
1	SEP DATA (S/D)
2	SECTOR (OPTION)
3	IND/SECT
4	SEP CLK (S/C)
5	KEY
6	DATA SEP CTRL (D/C)
7	OV
8	READ DATA (R/D)
9	+24V
10	+5V

The blank PWB (Part No. 20204-001) is available from ORBIS. The connector mounted on this option PWB is a 10-pin connector, Molex 09-52-3101 (ORBIS Part No. 16638-010). The mounting location in the diskette drive is shown in Figure 28.

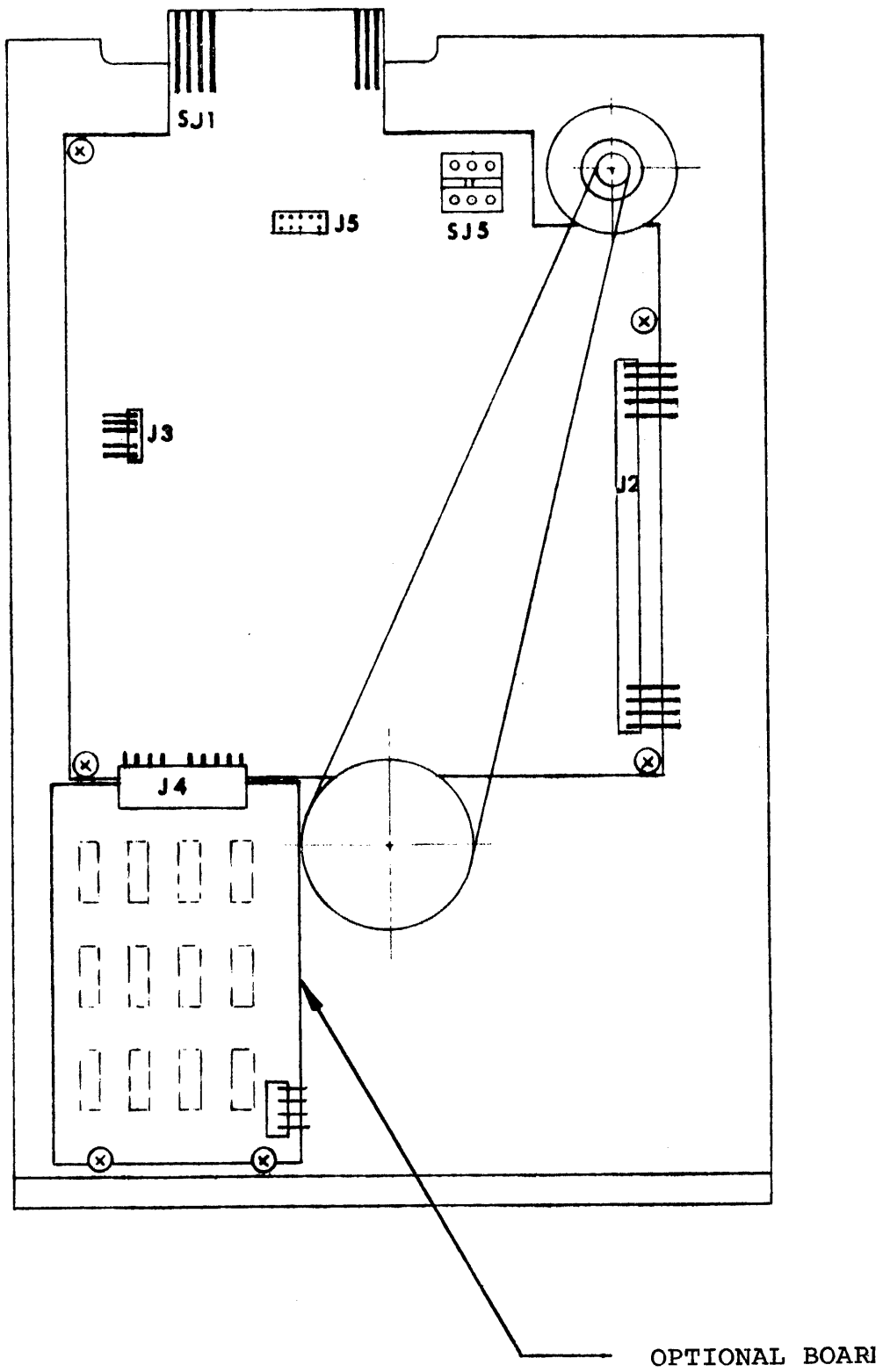

FIGURE 28

OPTIONAL BOARD FOR J4

7.2 FACTORY INSTALLED OPTIONS

7.2.1 Write Protect

This option (ORBIS part #20231-001) when installed detects the notch in the diskette package. The signal (write protect) at the main interface SJ1-44 becomes active when a notched diskette is installed. In a standard drive it will not inhibit writing on notched diskette, however if file unsafe logic option (see Section 7.1.7) is enabled by the customer then writing is inhibited. This option can also be used for identifying special use diskettes.

7.2.2 Write Enable

This option (ORBIS part #30012-001) when installed on the drive, changes the write protect signal to active (low) level on the main interface SJ1-44. The level indicates that write enable switch located in the upper left mouth of the drive has not been engaged by the diskette (see Figure 29). In order to change the write protect signal to inactive level it is necessary to activate this switch. This is achieved by the action of inserting the diskette such a way as to lift the switch lever away from normal position. When the diskette is removed the drive automatically reverts to an active level on write protect signal (SJ1-44). This option thus enables the use of a standard diskette without any alterations to its package.

7.7.3 Status Indicators

This option (ORBIS part #20232-XXX) provides two front panel lamps which indicate 'ready' (green) and 'selected' (red) conditions of the drive. The indicators could also be connected to show head load, write protect, or host controlled function via an alternate I/O pin. The following three options are available.

- a. 20232-001: Standard drive with red and green indicators.
- b. 20232-002: Drive with oversize front bezel option with red and green indicators.
- c. 20232-003: Standard drive with single red indicator.

See Figure 30 for the location of the indicator lights option.

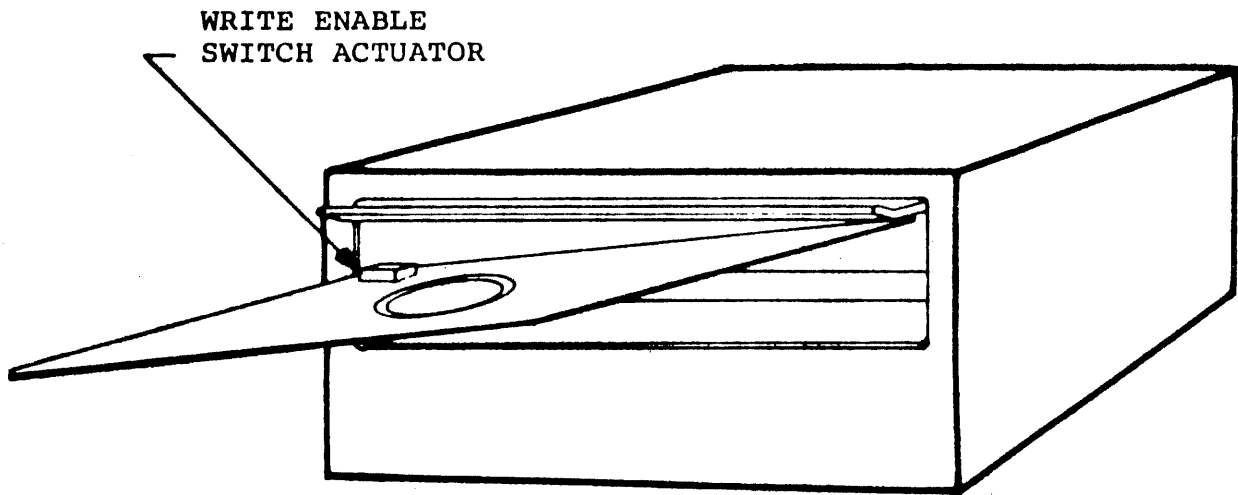

On insertion, the corner of the diskette is placed under the write enable switch actuator and the normal load operation follows. The diskette is now available for writing.

On removal of the diskette, the drive reverts to its "write protect" mode.

Figure 29. WRITE ENABLE SWITCH

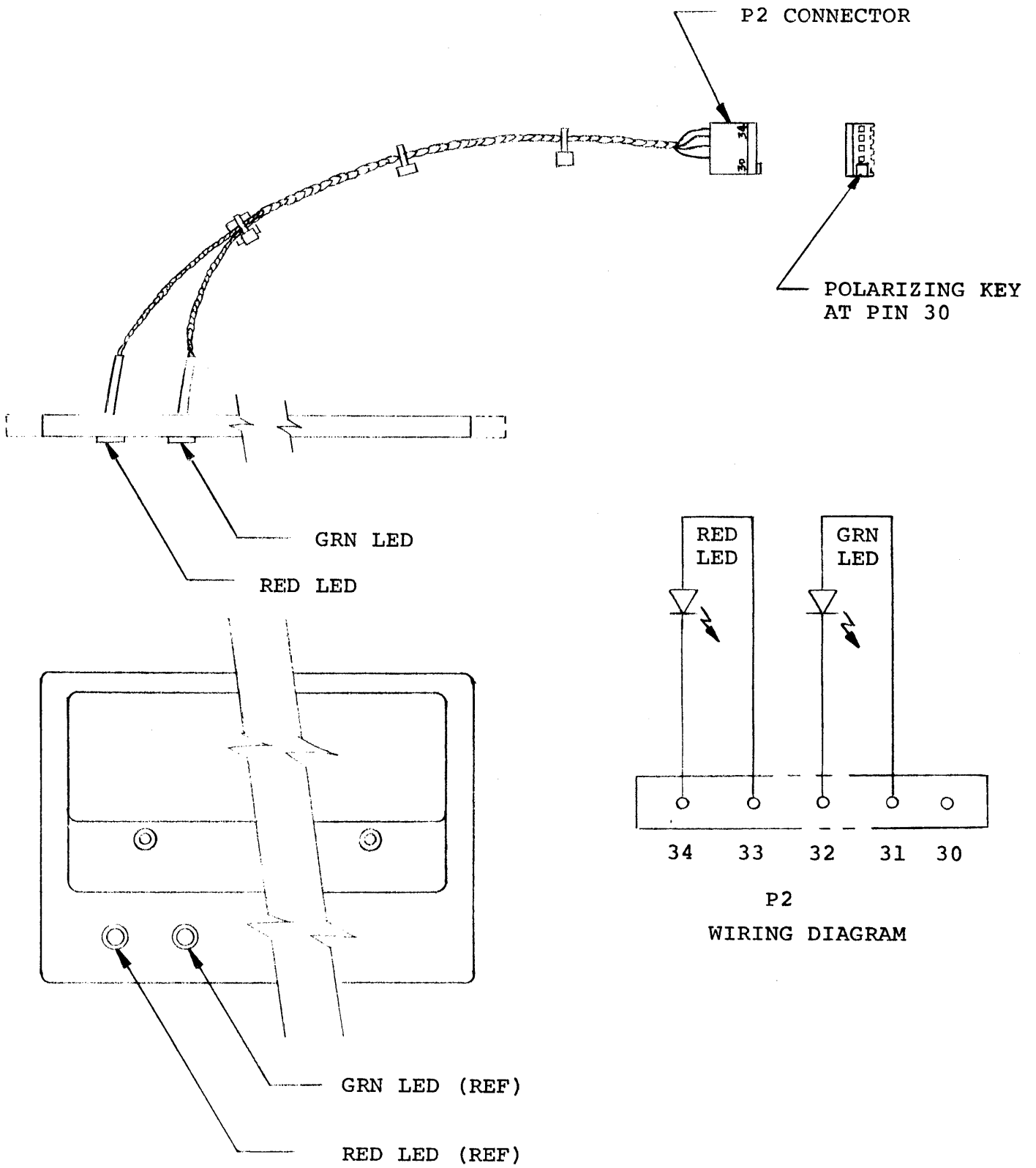

FIGURE 30
 OPTIONAL INDICATORS (LED)

7.2.4 Electronic Sector

This option (ORBIS part #40070-001) allows the user to use IBM media in hard sector data format mode. No alteration to IBM media is or package is required. The Sector option provides to the host system 32 output signals per revolution of the diskette, which enables the user the ability to divide the recording track into 1, 2, 4, 8, 16, or 32 sectors. The sector pulses are related to the index pulse as shown in Figure 31.

Sector pulses track the rotational speed of the drive and provide storage element position information. Figure 36 shows a recording format for 2, 4, 8, 16 and 32 sectors/track using the electronic sector option.

7.2.5 Chassis Slides

The dimensions of the optional chassis slides for the Models 76/S are shown in Figure 32.

7.2.6 Inhibit Stepping Further In Than Track 77

This option (ORBIS part #630253-001) enables the user to control stepping of the drive further in than Track 77. A switch is installed to detect the head after Track 77 and stepper logic is disabled for further stepping in. However, the step-out function performs normally. The switch is shown in Figure 33.

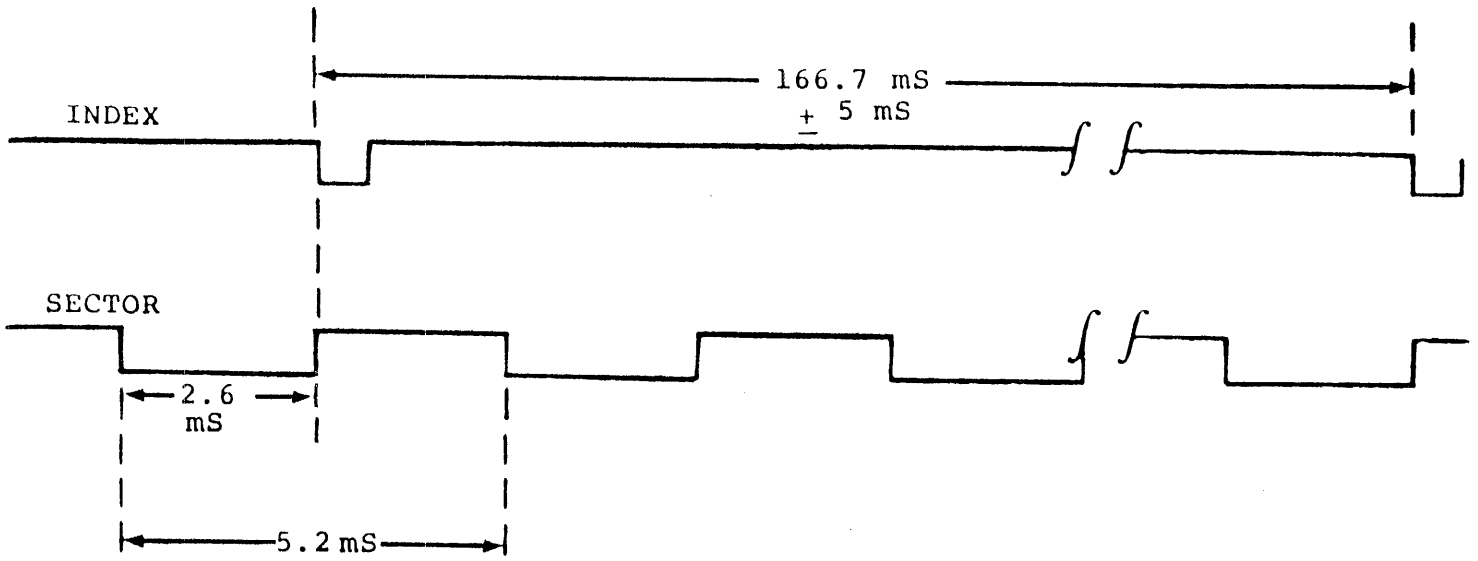
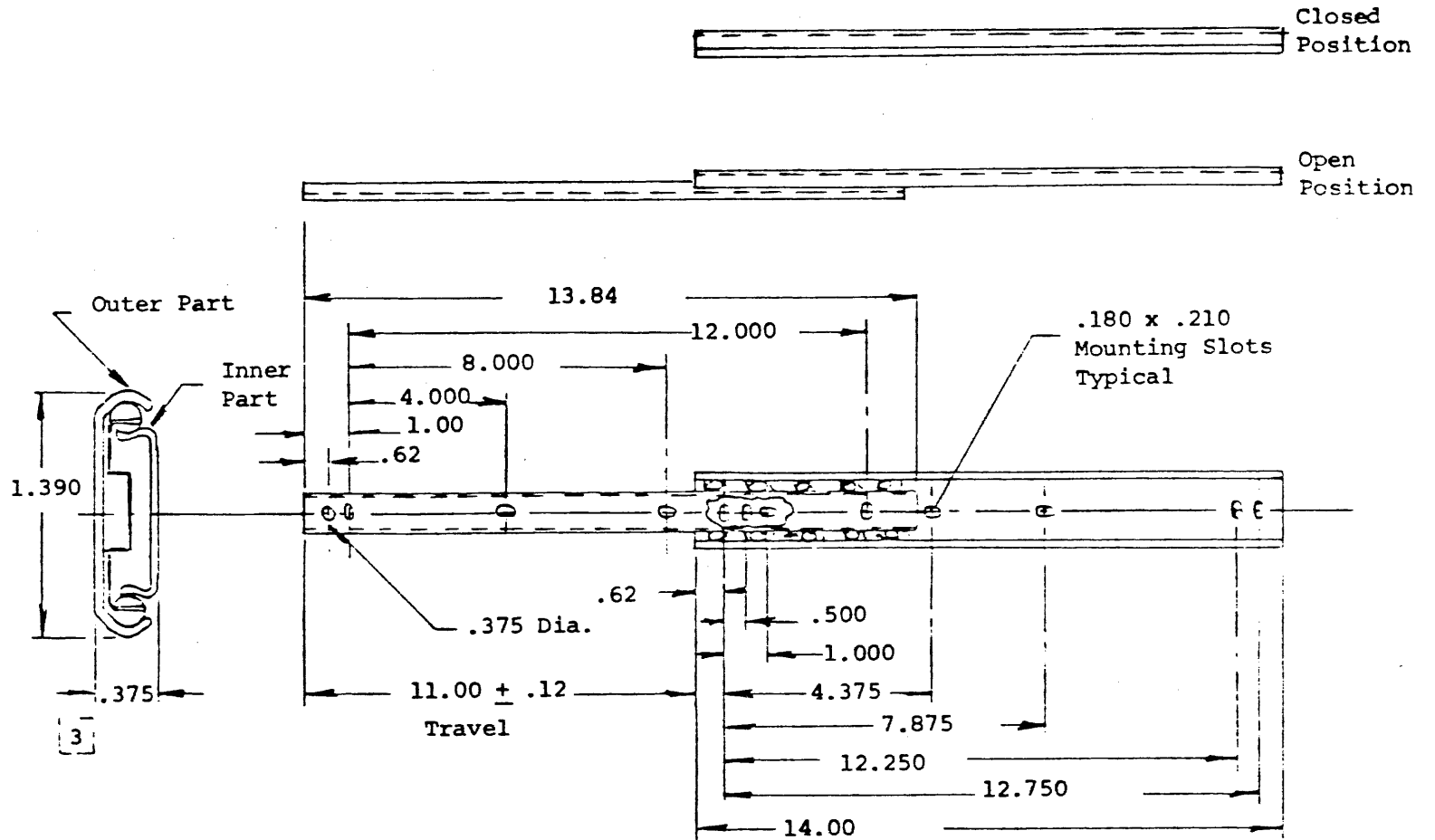

FIGURE 31

32-SECTOR/INDEX TIMING

Figure 32. SLIDE MOUNT DIMENSIONS



5. Use only #8 slotted pan head, slotted binding head, or phillips recessed binding head screws for mounting.
4. Drawing not to scale.
- [3]. End view different scale.
2. Slides to have friction stop.
1. Tolerances: .xx = ± .030, ± 1°
 .xxx = ± .010, holes ± .006

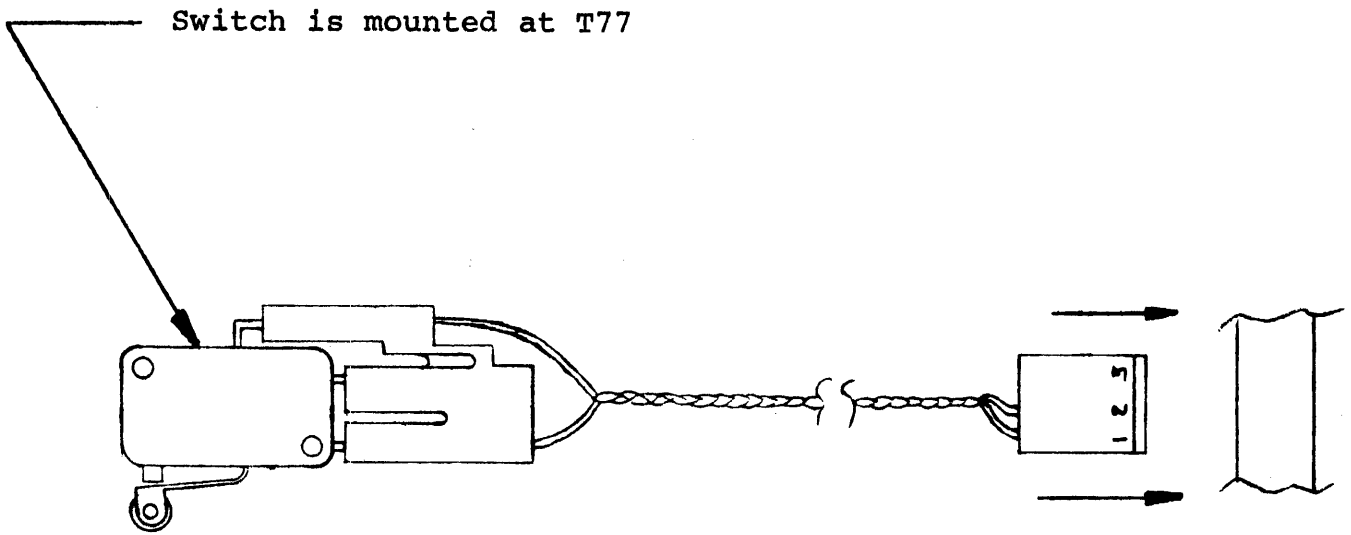

FIGURE 33
INHIBIT STEPPING FURTHER IN THAN TK 77

8.0 RECORDING FORMAT

The format of the data recorded on the diskette is totally a function of the host system and can be designed to the user's application to best take advantage of the total available bits that can be written on any one track.

8.1 IBM TRACK FORMAT

Figure 34 shows an example of IBM Track Format.

8.2 INDEX FORMAT

Figure 35 illustrates a format using index recording.

8.3 32-SECTOR FORMAT

Figure 36 shows a 32-Sector Format which may be used with hard-sector media or with ORBIS' Electronic Sector Option.

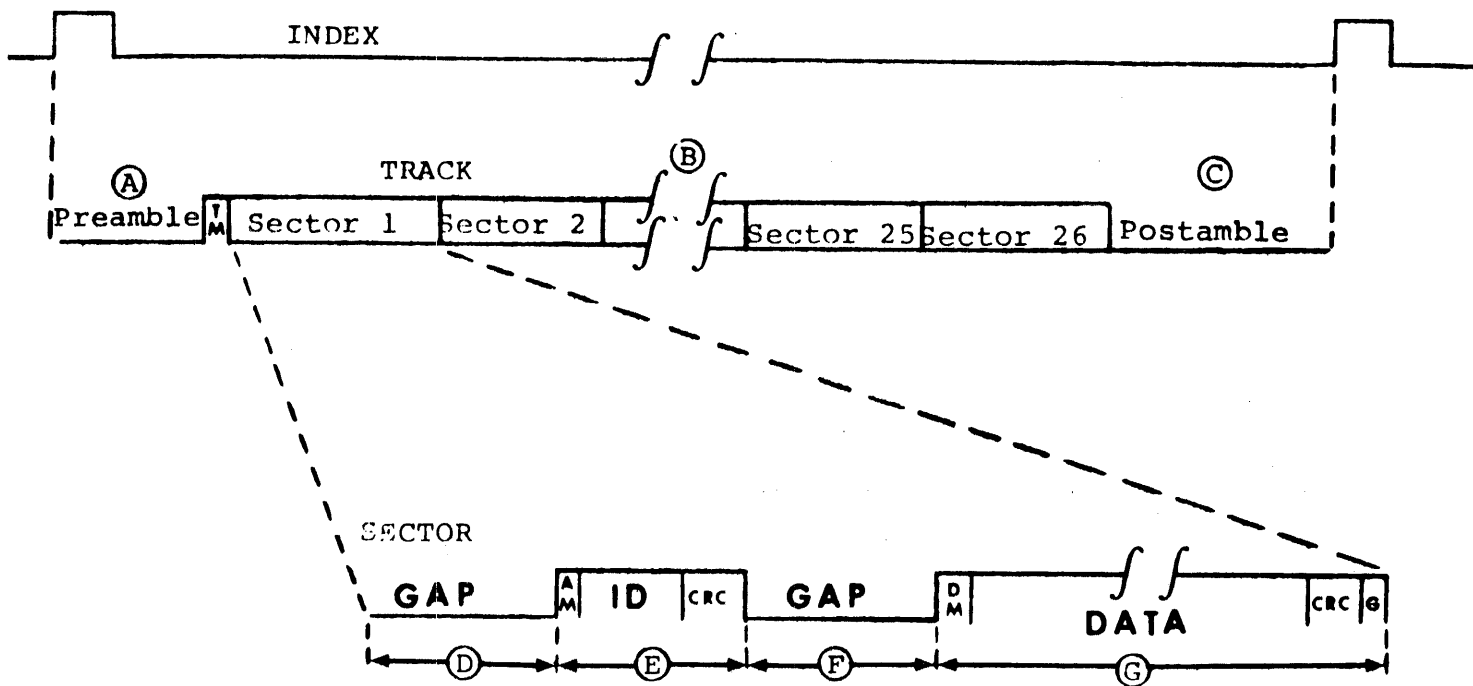

TRACK

Preamble (Gap)
 1. Gap = 46 Bytes
 2. TM = 1 Byte

26 Sectors
 @ 188 Bytes

Postamble (Gap)
 273 Bytes ±

SECTOR

Gap 1
 @ 32 Bytes

Sector ID
 1. AM = 1 Byte
 2. ID = 4 Bytes
 3. CRC = 2 Bytes

Gap 2
 @ 17 Bytes

Data
 1. DM = 1 Byte
 2. Data = 128 Bytes
 3. CRC = 2 Bytes
 4. G = 1 Byte

FIGURE 34.

IBM TRACK FORMAT (3740)

INDEX

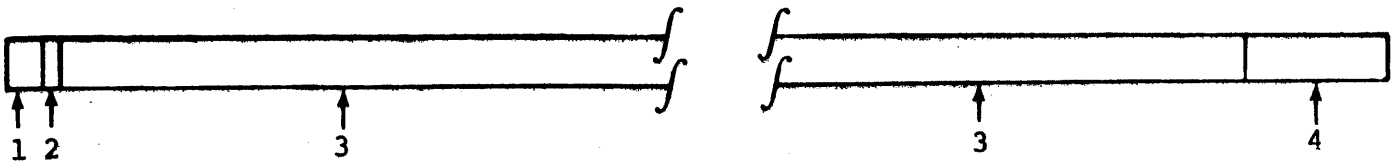
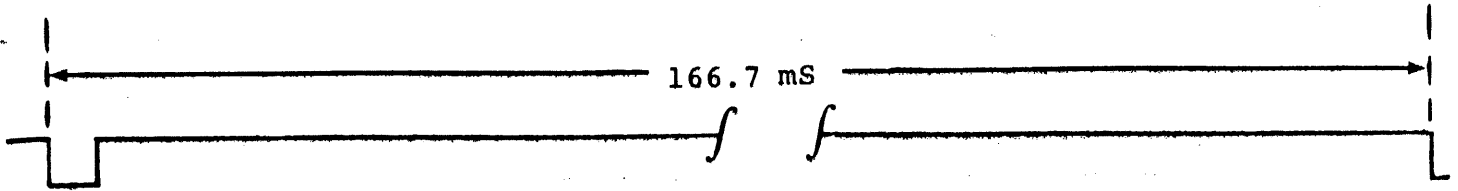

- 1 Preamble = 175 Bits
- 2 Data Mark = 1 Byte
- 3 Data = 40,441 Bits
- 4 Postamble = 331 Bits

INDEX FORMAT

FIGURE 35

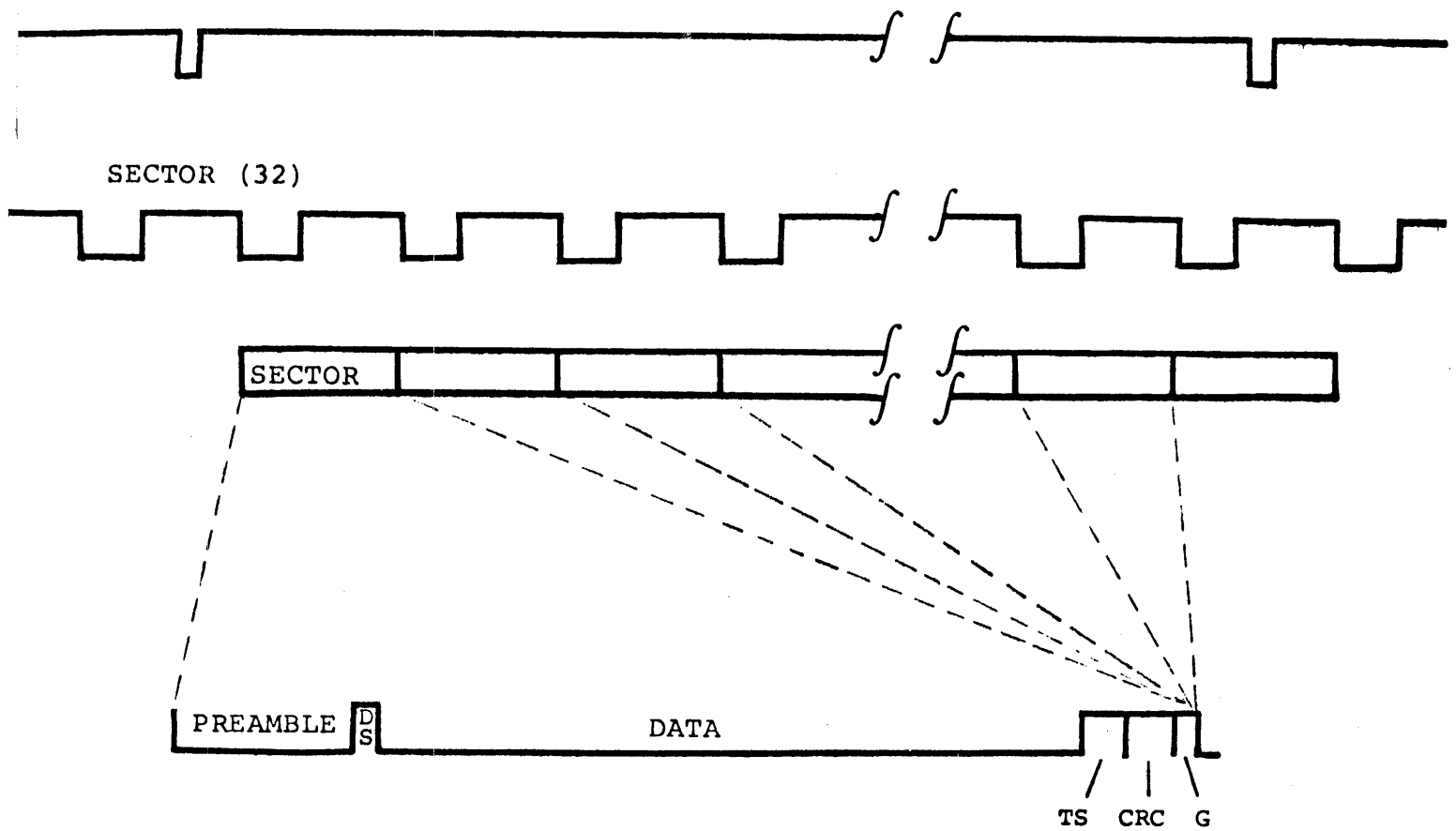

SECTOR CONTENTS

Preamble = 16 Bytes '00'
 Data Sync = 1 Byte
 Data = N Bytes
 Track & Sector = 2 Bytes
 CRC = 2 Bytes
 Guard = 1 Byte

32 Sector Data N = 128 Bytes
 16 Sector Data N = 286 Bytes
 8 Sector Data N = 602 Bytes
 4 Sector Data N = 1234 Bytes
 2 Sector Data N = 2498 Bytes

RECORDS/ TRACK	BITS/ RECORD	BITS/ TRACK	BITS/ DISC (77)
32	1,024	32,768	2,523,136
16	2,228	36,608	2,818,816
8	4,816	38,528	2,966,656
4	9,872	39,488	3,040,576
2	19,984	39,968	3,077,536

32 SECTOR FORMAT

FIGURE 36

9.0 OPERATION PROCEDURES

9.1 INTRODUCTION

The ORBIS Diskette Drive is designed for ease of operator use to facilitate a wide range of operator oriented applications. There are no complicated controls and indicators on the drive. The following section outlines procedures necessary for insertion of the diskette into the drive and for diskette handling. Also included are some suggested software procedures for handling error conditions which might occur during writing or reading operations.

9.2 DISKETTE LOADING

The diskette consists of the flexible disk encased in a plastic jacket. When not in use the diskette is always stored in a protective envelope. An analogy of this protective storage envelope would be that of the envelope used to store phonograph records used in your home. The storage envelope affords the same protection from dust and contaminants.

Load as follows:

1. Remove the diskette from its storage envelope.
2. Open the drive door.
3. Insert the diskette (properly oriented).
4. Close the drive door while gently holding the diskette in.

The diskette is loaded with all power on and the spindle motor rotating to allow optimum registration in the drive.

9.3 DISKETTE UNLOADING

1. Open the door; the diskette will gently eject.
2. Remove the diskette.

3. Return the diskette to its protective storage envelope. The diskette may be unloaded with the spindle stationary or rotating.

9.4 DISKETTE HANDLING

To protect the diskette, the same care and handling procedures specified for computer magnetic tape apply. These precautionary procedures are as follows:

1. Return the diskette to its storage envelope whenever it is removed from the drive.
2. Store diskettes vertically.
3. Keep diskettes away from magnetic fields and from ferromagnetic materials which might become magnetized. Strong magnetic fields can distort recorded data on the disk.
4. Replace storage envelopes when they become worn, cracked or distorted. Envelopes are designed to protect the diskette.
5. Do not write on the diskette with a lead pencil or ball-point pen. Use a felt tip pen.
6. Do not smoke while handling the diskette. Head and contamination from a carelessly dropped ash can damage the disk.
7. Do not expose diskettes to heat or sunlight. The read/write head on the drive cannot properly track a warped disk.
8. Do not touch or attempt to clean the disk surface. Abrasions may cause loss of stored data.

9.5 ERROR DETECTION AND CORRECTION

9.5.1 Write Errors

If an error occurs during a write operation, it will be detected on the next revolution by doing a read operation commonly called a "write check". To correct the error, another write and write check operation must be done. If the write operation is not successful after ten attempts have been made, error correction should be attempted on another track. If the error still persists, the diskette should be considered defective and discarded or re-initialized.

9.5.2 Read Errors

Most errors that occur will be "soft" errors; that is, by performing an error recovery procedure the data will be recovered.

Soft errors are usually caused by:

- a. Airborne contaminants that pass between the read/write head and the disk. These contaminants will generally be removed by the cartridge self-cleaning wiper.
- b. Random electrical noise which usually lasts for a few microseconds.
- c. Small defects in the written data and/or track not detected during the write operation which may cause a soft error during a read.

9.5.3 Error Recovery Procedure

The following procedures are recommended to recover from the above mentioned soft errors:

- a. Reread the track ten times or until such time as the data is recovered.
- b. If data is not recovered after using Step a, access the head to the adjacent track in the same direction previously moved, then return to the desired track.
- c. Repeat Step a.
- d. If data is not recovered, the error is not recoverable.

10.0 MAINTENANCE AND RELIABILITY

10.1 DESIGN LIFE

The ORBIS Diskette Drive is designed and constructed to provide a useful life of five years or 15,000 hours, whichever occurs first, before a factory overhaul or replacement is required. Repair or replacement parts will be permitted during the lifetime.

10.2 MEAN TIME BETWEEN FAILURES (MTBF)

Following an initial period of 200 hours, MTBF shall exceed 5,000 hours. The following expression defines MTBF:

$$\text{MTBF} = \frac{\text{Operating Hours}}{\text{No. of Equipment Failures}}$$

Operating hours mean total "power on" hours less any maintenance time. Equipment failures mean any stoppage or substandard performance of the equipment because of equipment malfunction. Equipment failure shall exclude down time or substandard performance caused by operator error, adverse environment, power failure, controller failure, cable failure or other failure not caused by the disk drive. To establish a meaningful MTBF, operating hours must be greater than 2,500 hours and shall include all sites where the disk drives are used.

10.3 MEAN TIME TO REPAIR (MTTR)

Mean time to repair shall be less than .5 hour, and is defined as the time for an adequately trained and competent serviceman to diagnose and correct a malfunction.

10.4 RECOVERABLE READ ERROR RATE

Less than one error in 10^{10} bits.

10.5 NON-RECOVERABLE READ ERROR RATE

Less than one error in 10^{12} bits read. A read error is defined as non-recoverable after ten successive read attempts of same data fail.

Errors attributed to the diskette will not be included in determining the non-recoverable read error rate.

10.6 ACCESS POSITIONING ERROR RATE

Less than one error per 10^6 seek executions.

10.7 INTERCHANGEABILITY

The ORBIS Model 76S Diskette Drives are designed to be media interchangeable with all other ORBIS Model 74, 76 and 77 Diskette Drives and the IBM 3741, 3742, 3747, 3540, 3600 and System 32.