

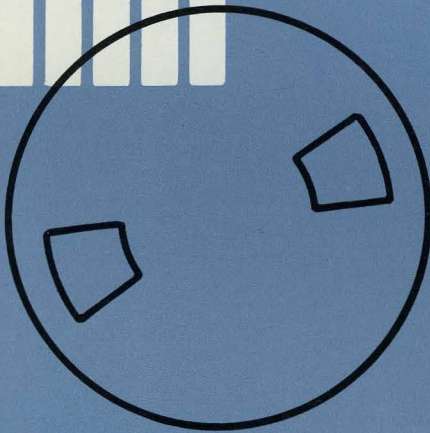

UNIVAC[®]
1540/1541
Magnetic
Tape
Units



TECHNICAL DESCRIPTION



V. L. SANDUSKY

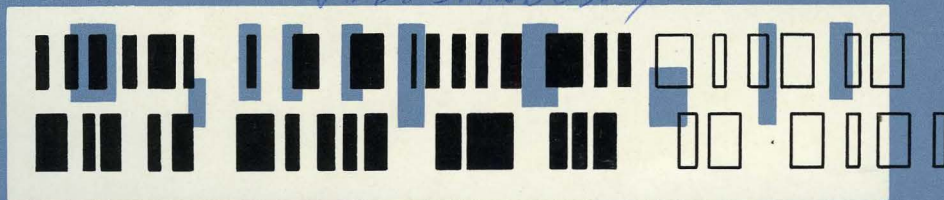

3 Transp. 4 mod. unit

UNIVAC
1540 AND 1541
MAGNETIC TAPE UNITS

Technical Description

TABLE OF CONTENTS

Title	Page
General Information	1
Modularity	1
Specifications and Standards	3
Electronics	6
Maintenance	6
Tape Unit Characteristics	6
Power and Cooling Requirements	7
Magnetic Tape to Computer Characteristics	7
Magnetic Tape Unit – High-Speed Printer Off-Line Capability	24

LIST OF TABLES

Table	Title	Page
1	Word Assembly Time (Microseconds)	13
2	Chart Showing the Effects of Various UNIVAC Computers Operating with the UNIVAC 1540 or 1541 Magnetic Tape Subsystems	19
3	Operation Codes	20
4	Type Symbols and Codes	26

ILLUSTRATIONS

Figure	Title	Page
1	UNIVAC 1540 Magnetic Tape Unit	IV
2	UNIVAC 1541 Magnetic Tape Unit	IV
3a	UNIVAC 1540 Magnetic Tape Units and Computer Configuration	2
3b	UNIVAC 1541 Magnetic Tape Units and Computer Configuration	3
4	Dimensional Data for 1540 Basic Magnetic Tape Unit (Air-Cooled)	4
5	Dimensional Data for 1541 Basic Magnetic Tape Unit (Air-Cooled)	5
6	Magnetic Tape Unit – Computer Interface	8
7	Type 1540 Magnetic Tape System (Maximum Configuration)	9
8	Type 1541 Magnetic Tape System (Maximum Configuration)	9
9	Tape Format	10
10	Magnetic Tape Unit – Status Word Format	11
11	External Function Word Format	15
12	Bi-octal Tape Format	16
13	Octal Tape Format	17
14	Magnetic Tape Unit – Tape File	24
15	Transmit-Extra Computer Word Format	25
16	Magnetic Tape – Printer Interface	27

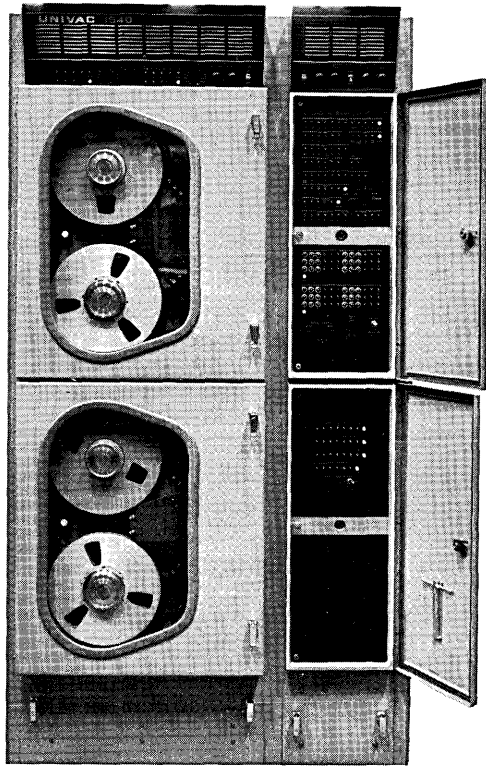

PHYSICAL CHARACTERISTICS

Type	Equipment	Height (inches)	Width (inches)	Depth (inches)	Weight (pounds)
1540	Basic Unit	72	38	30	1700
1540	Add-On	72	26	30	1300

Figure 1. UNIVAC 1540 Magnetic Tape Unit

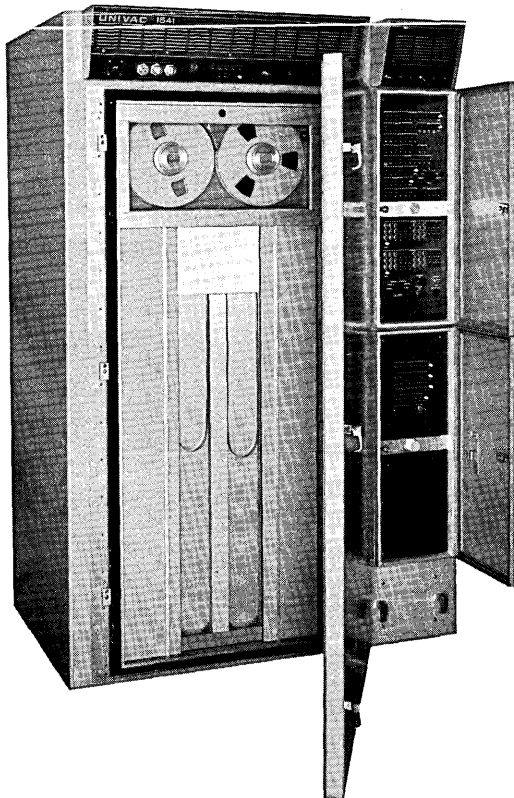

Type	Equipment	Height (inches)	Width (inches)	Depth (inches)	Weight (pounds)
1541	Basic Unit	72	48	31	1500
1541	Add-On	72	35	31	1100

Figure 2. UNIVAC 1541 Magnetic Tape Unit

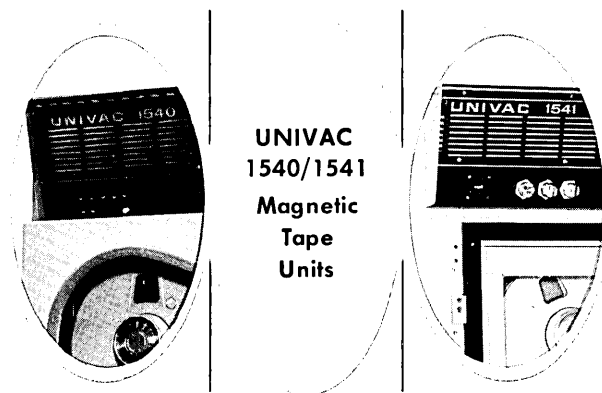

GENERAL INFORMATION

The militarized UNIVAC 1540 and 1541 Magnetic Tape Units (see Figures 1 and 2) provide large capacity auxiliary storage devices for computing systems operating under severe environmental conditions. UNIVAC tape system engineers, through their experience in designing shipboard and land-based equipment to meet military system requirements, have designed and built the rugged, reliable and responsive, medium-speed, digital data magnetic tape storage units to exacting military standards. At the same time, these units incorporate improvements and advances in the state-of-the-art. The rugged design of cabinetry and packaging of components permit use of the magnetic tape unit in vans, ships, air-transportable helihuts or other enclosures of computer equipment designed to "go where the action is".

The UNIVAC 1540 Magnetic Tape Unit employs a pinch-roller type of tape transport and the 1541 Unit is equipped with a single capstan vacuum loop transport. The units are functionally identical, however, the 1541 has a higher data transfer rate. The UNIVAC 1540/1541 Magnetic Tape Units may be operated on-line under complete computer program control as an input/output storage device or with a high-speed printer for off-line printing of tape recorded information. A flexible format allows recording and reading of four moduli (18-, 24-, 30-, or 36-bit computer words) and three densities, and

provides recording of magnetic tapes which is compatible in all respects with industry-accepted tape systems. Either even or odd frame parity may be utilized and for added reliability, the redundant octal format is provided. A Read-after-Write feature checks each frame for parity immediately after recording. Longitudinal parity recording and checking are automatic. A duplexing capability is provided so that two computers communicating with the same magnetic tape unit may share its facilities under program control. In this way, data or programs stored on one tape are available to both computers. Further savings in the facilities are enhanced by the ability of the 1540/1541 Magnetic Tape Units to read information in either the forward or backward motion of the tape.

Records of data may be of variable lengths and are separated by 3/4-inch interrecord gaps (IRG) unless otherwise extended by suitable programming. Records may be lengthened if suitable interrecord gaps were provided in previous recordings.

Either the UNIVAC 1540 or 1541 Magnetic Tape Unit is compatible with all UNIVAC Military Computers and may be supplied with an 18-, 24-, 30-, or 36-bit parallel input/output interface with either of two sets of signal levels. Compatibility both in tape format and computer programs with the UNIVAC 1240 Magnetic Tape Unit is provided through a manual switch selection on the 1540 or 1541 Basic Unit. This feature gives the functional characteristics that are identical with those of the 1240 subsystem and permits the use of software packages designed for earlier systems.

MODULARITY

Each UNIVAC 1540/1541 Magnetic Tape Unit (MTU) is designed to provide a flexible, yet expandable storage subsystem to meet varied requirements. The Basic Unit, attached to any computer channel, contains the interface and logic circuitry required for a minimum system as well as for a maximum configuration. The 1540 Magnetic Tape Unit consists of from one to four individual cabinets each containing two pinch roller type tape handlers (see Figure 3a). The 1541 Magnetic Tape Unit consists of from one to eight individual cabinets each containing one vacuum type tape handler (see Figure 3b). The 1540 Basic Unit contains two tape handlers

with associated read/write electronics and one Magnetic Tape Control (MTC). Each 1540 Add-On Unit contains two tape handlers and associated read/write electronics. The 1541 Basic Unit contains one tape handler with associated read/write electronics and one Magnetic Tape Control. Each 1541 Add-On

Unit contains one tape handler and associated read/write electronics. The Magnetic Tape Control provides the necessary interface and control logic for one computer channel and for up to eight tape handlers.

1540
MINIMUM CONFIGURATION

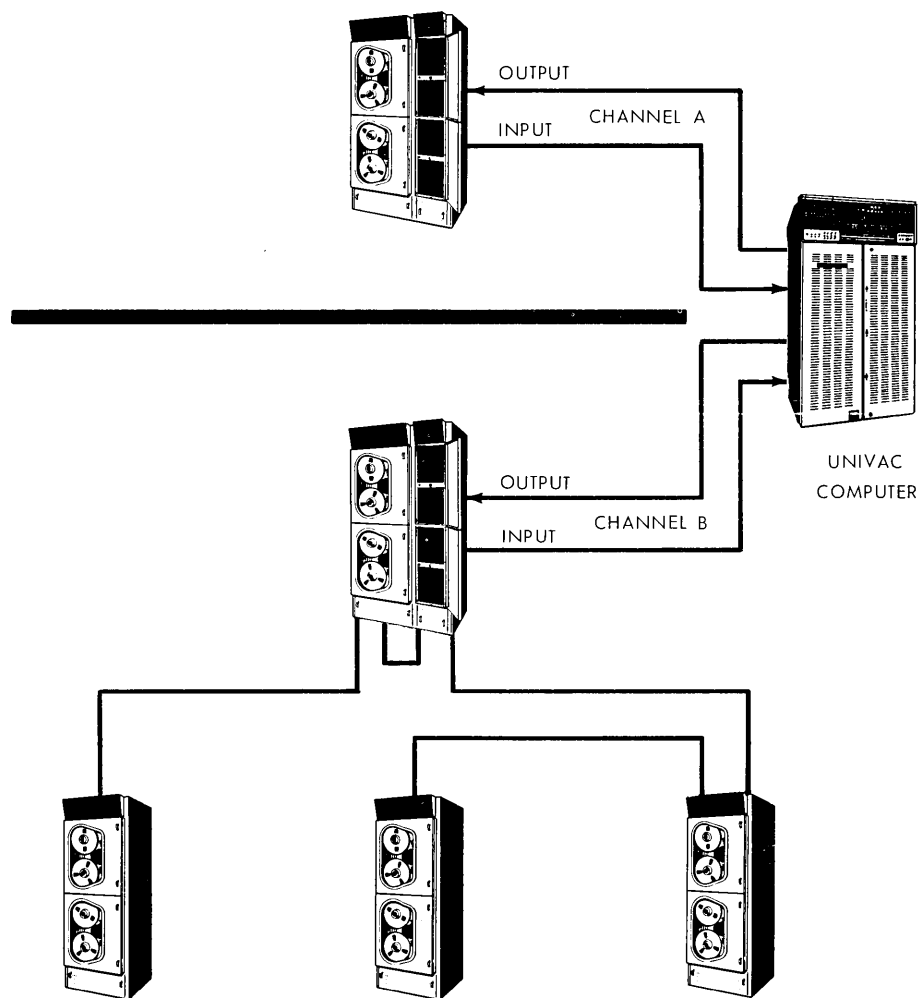

1540
MAXIMUM CONFIGURATION

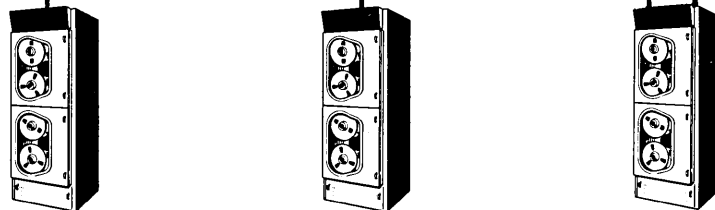

Figure 3a. UNIVAC 1540 Magnetic Tape Units and Computer Configuration

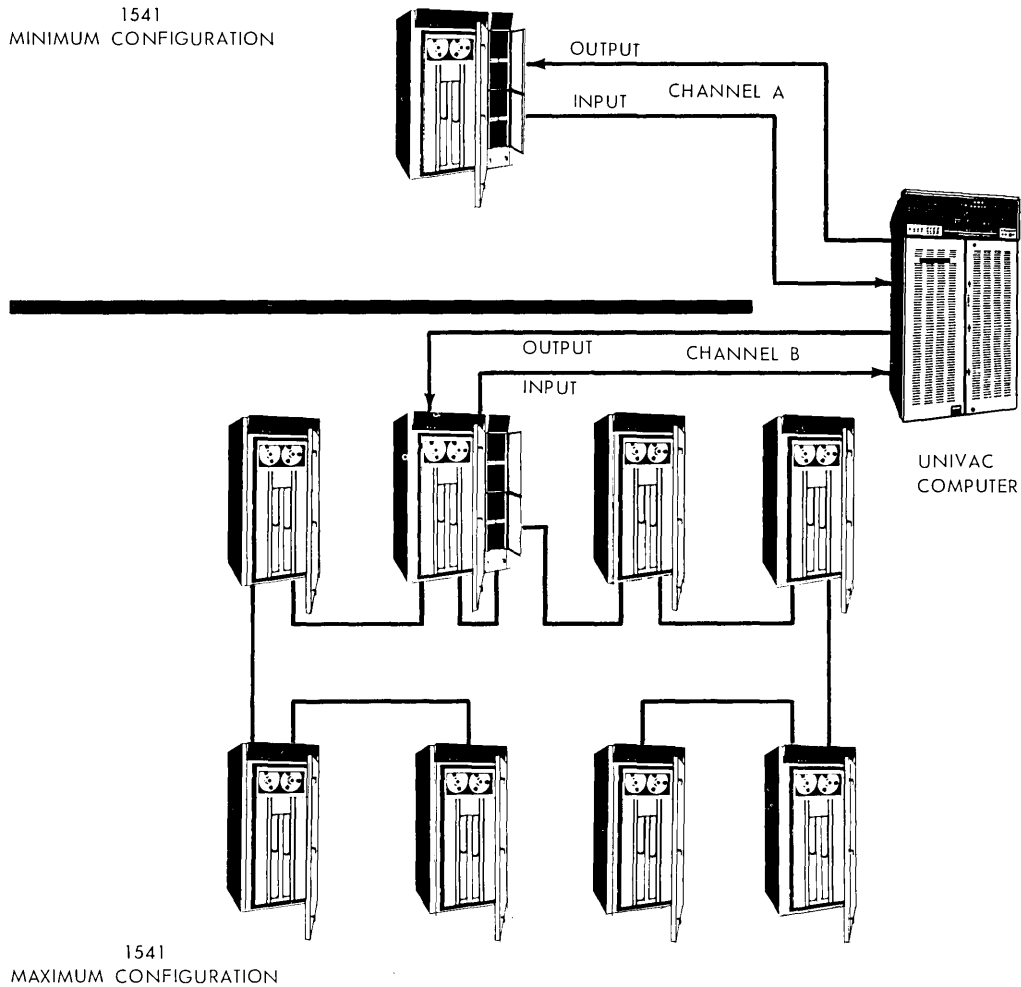

Figure 3b. UNIVAC 1541 Magnetic Tape Units and Computer Configuration

SPECIFICATIONS AND STANDARDS

The UNIVAC 1540/1541 Magnetic Tape Units were designed to meet military specifications and standards in the following respects:

Temperature:	MIL-E-16400, Class 4 (0° to 50° operating, -62° to + 75° non-operating)	Salt Spray:	Federal Test Method STD 151, Method 811
Humidity:	MIL-E-16400 (to 95 percent including condensation)	External Radiation:	MIL-E-16910 (1 volt per meter over 14 KC-1000 MC)
Enclosure:	MIL-STD-108	Shock:	MIL-S-901, Class II (deck mounted)
		Vibration:	MIL-STD-167, Type I
		Inclination:	MIL-E-16400

Outline and dimensional data for the 1540 and the 1541 Basic Units are shown in Figures 4 and 5, respectively.

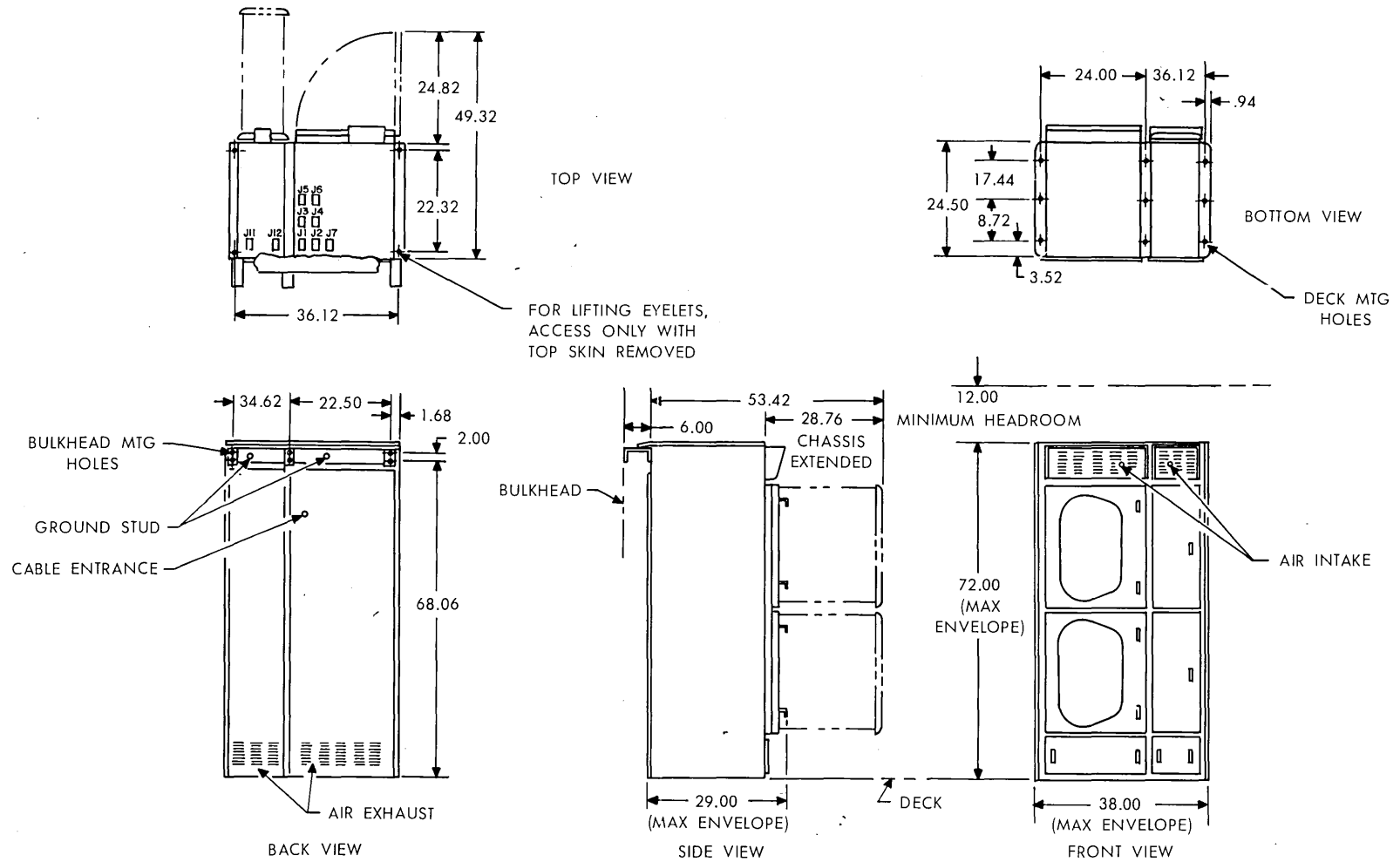

Figure 4. Dimensional Data for 1540 Basic Magnetic Tape Unit (Air-Cooled)

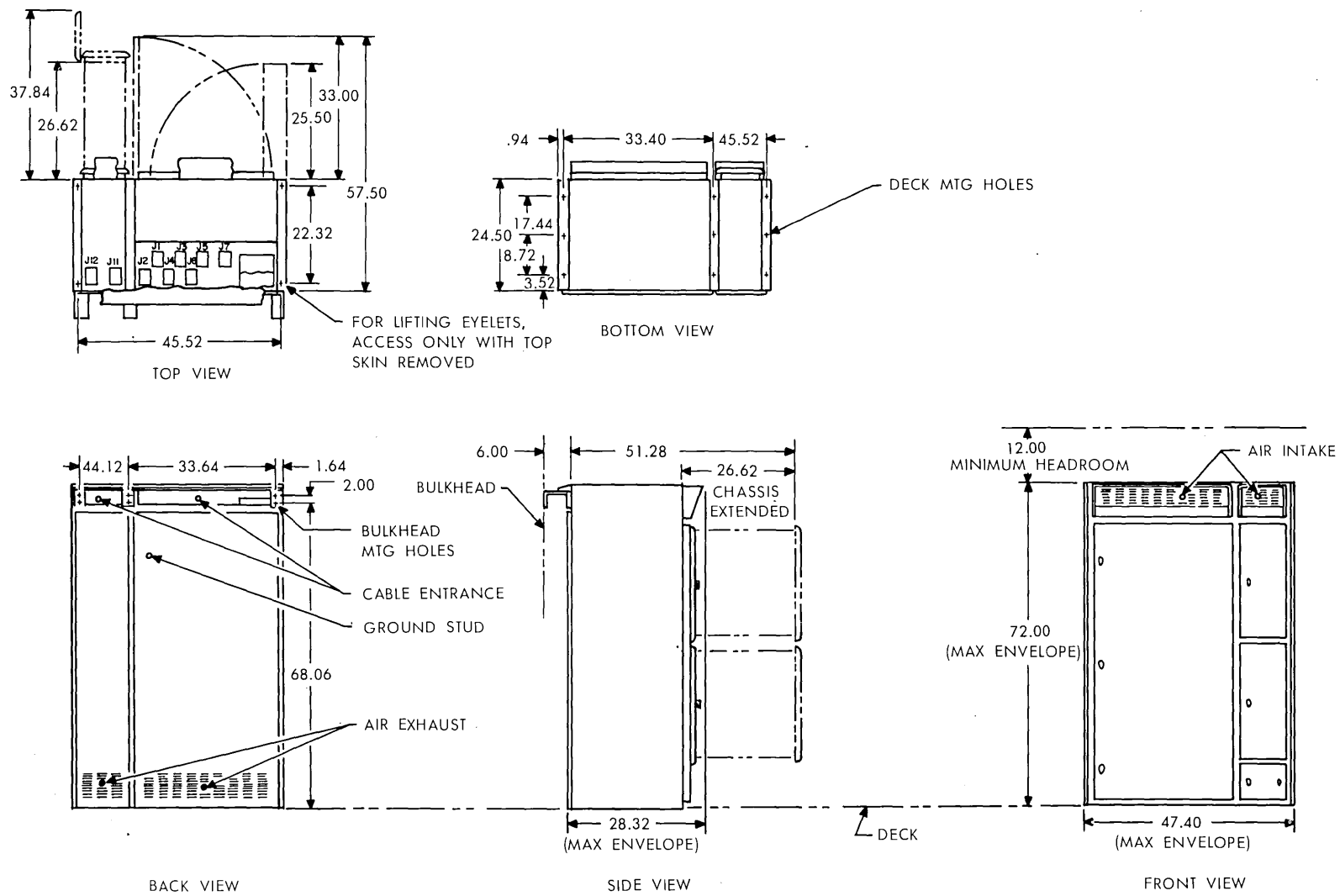
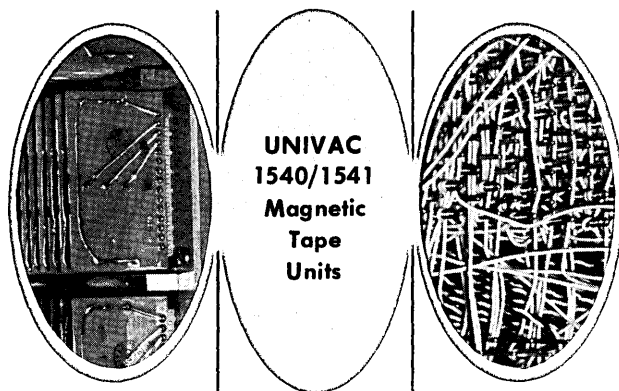

Figure 5. Dimensional Data for 1541 Basic Magnetic Tape Unit (Air-Cooled)



ELECTRONICS

Both the UNIVAC 1540/1541 Units are completely solid-state machines. The components are mounted on small, plug-in, printed-circuit cards which are assembled in a modular form for compactness. This building block technique and the circuit cards utilized in the 1540/1541 have a field-proven record of reliability in UNIVAC computers and peripheral equipment. The modular chassis use wire-wrapped circuitry for improved reliability.

MAINTENANCE

The solid-state, plug-in modules, in conjunction with the manual controls and register and logic indicators, make maintenance of the UNIVAC 1540/1541 fast and easy, keeping repair time to a minimum. Manual controls permit off-line maintenance of one tape unit during on-line operation of other units in the system. The tape transports and all electronics are easily accessible from the front of the unit. Preventive maintenance procedures and adjustments have been simplified by several mechanical and electrical improvements.

TAPE UNIT CHARACTERISTICS

Tape

Width - 1/2 inch
 Type - "A" wound (oxide coating on inside of tape) - metallic base
 Length - 3600 feet maximum
 Reels - 10-1/2 inch, compatible hub type
 Tape Markers - Load Point and End of Tape reflection markers
 Method of Tape Movement - Tension Arm

and Pinch Rollers (1540), Vacuum Loop and Capstan (1541)
 Reading Methods-Forward or Backward(High, medium, or low bias)
 Tape Supply Detectors - Mechanical (1540), Photo-electric (1541)

Tape Speed

	1540	1541
Read/ Write	120 ips	150 ips
Rewind	240 ips	225 ips
Start/ Stop Time	3/1.5 ms	3.25 ms

Recording Techniques

Nonreturn to Zero (change-on-one)
 Seven tracks - Six data bits, one parity bit
 Density - 200, 555.5, or 800 frames per inch (Program Controlled)
 Interrecord Gap - 3/4 inch
 Extended Interrecord Gap - 3-1/2 inches
 Record Length - Variable
 Parity - Lateral and Longitudinal
 Tape Mark - End of File (Program Controlled)
 Write Lockout - Standard Type, upper reel (1540) or right reel (1541)

Transfer Rate

	1540	1541
Characters per second - High Density	96,000	120,000
Characters per second - Medium Density	66,700	83,300
Characters per second - Low Density	24,000	30,000

Format (Program Controlled)

Moduli - 3, 4, 5, or 6
 Frame Character - Biocctal or Redundant Octal
 Parity - Odd or Even

Tape Compatibility

Transport to transport
 Other compatible systems

POWER & COOLING REQUIREMENTS

	Basic Unit		Add-On Unit	
	1540	1541	1540	1541
Power – Air Cooled Units				
115V ± 10% 1 Phase 60 CPS ± 5%	1.8 kva	1.5 kva	1.7 kva	1.4 kva
115V ± 5% 3 Phase 400 CPS ± 5%	0.6 kva	0.6 kva	0.1 kva	0.1 kva
Air Supply – 70 °F	600 cfm	600 cfm	400 cfm	400 cfm
Power – Water Cooled Units				
115V ± 10% 1 Phase 60 CPS ± 5%	1.6 kva	1.3 kva	1.6 kva	1.3 kva
115V ± 5% 3 Phase 400 CPS ± 5%	1.0 kva	1.0 kva	0.4 kva	0.4 kva
Water Supply – 70 °F	4 gal/min	4 gal/min	4 gal/min	4 gal/min

MAGNETIC TAPE TO COMPUTER CHARACTERISTICS

Performance of Function

Either the 1540 or 1541 Magnetic Tape Unit communicates with the computer in the Request-Acknowledge mode (see Figure 6). The computer issues commands to the Magnetic Tape Unit by means of the External Function signal and Function Words. Computers with an 18-bit word structure (e.g., the UNIVAC 1218 and 1219) can use the 1540/1541 Tape Units as well as computers with longer word lengths. When the Magnetic Tape Control inspects the function word it selects the specified tape transport and performs the specified operation. Each Tape Transport Cabinet contains a 16-position Address Switch for each tape transport so that each can be assigned a logical number (1 through 16). UNIVAC 1540/1541 programs use positions 1 through 8 only. The additional positions (9 through 16) are used to provide compatibility with UNIVAC 1240 programs. The address selection bits of the Instruction Word are interpreted by the Magnetic Tape Control according to the physical position of these switches. No two transports may be assigned the same logical number (i.e., to allow identical function on both units). If duplication does exist, priority is allocated to the transport at the most remote position to the left of the basic unit (the top transport having priority over the bottom unit in the 1540) regressing toward the basic unit, then those connected to the right side beginning at the remote position. The operator

must determine the logical addresses required by each program and set the switches accordingly. (See Figures 7 and 8 for order of priority scheme.)

The Instruction Word will contain the code for one of six basic operations – Duplex Selection, Read, Search, Write, Space File, and Rewind – or a combination of two basic operations. To accept an External Function Command, the Magnetic Tape Unit must be in the READY state (i.e., operable but not performing a specific operation). The completion of an operation or a Master Clear places the Magnetic Tape Unit in the READY state.

The general sequence of events for on-line operation with a computer (the Magnetic Tape Control in Automatic mode and in the READY state) is as follows:

- Computer issues an Instruction Word via the External Function command;
- Magnetic Tape Control samples the Instruction Word and becomes BUSY;
- Magnetic Tape Control selects the addressed tape transport;
- Operations stated in the Instruction Word are initiated and carried to completion;
- Magnetic Tape Control sets a Status Word on the input lines as described in subsequent paragraphs;
- Magnetic Tape Control interrupts the Computer with External Interrupt Signal after completion of the operation;

- Magnetic Tape Control issues STOP command to transport;
- Computer samples Status Word and acknowledges Interrupt whereby the Magnetic Tape Unit becomes IDLE.

(The latter two items may be interchanged, or may take place simultaneously.)

Status Words and Input Data are transferred on the Input Lines with identifying signals on the External Interrupt Line and the Input Request Line, respectively. The computer acknowledges receipt of these transfers via the Input Acknowledge Line.

Function Words and Output Data are transferred on the Output Lines with identifying signals on the External Function Line and the Output Acknowledge Lines, respectively. The Output Request Line notifies the computer of the Magnetic Tape Unit ability to accept Output Data.

Duplexing

Either of two computers with compatible interface can exercise control over the Magnetic Tape Unit when the duplexing capability is utilized. The following duplex control functions are provided via the Instruction Word:

- Demand Duplex Control (Master Clear)
- Request Duplex Control
- Release Duplex Control

To complete the communication, the Status Word with Interrupt provides Duplex Control status to the computers as follows:

- Not in Duplex Control
- In Duplex Control

Through these messages, each computer has control of the switching functions of the duplexer and each is informed of the operational status of the Magnetic Tape Units it shares with the other.

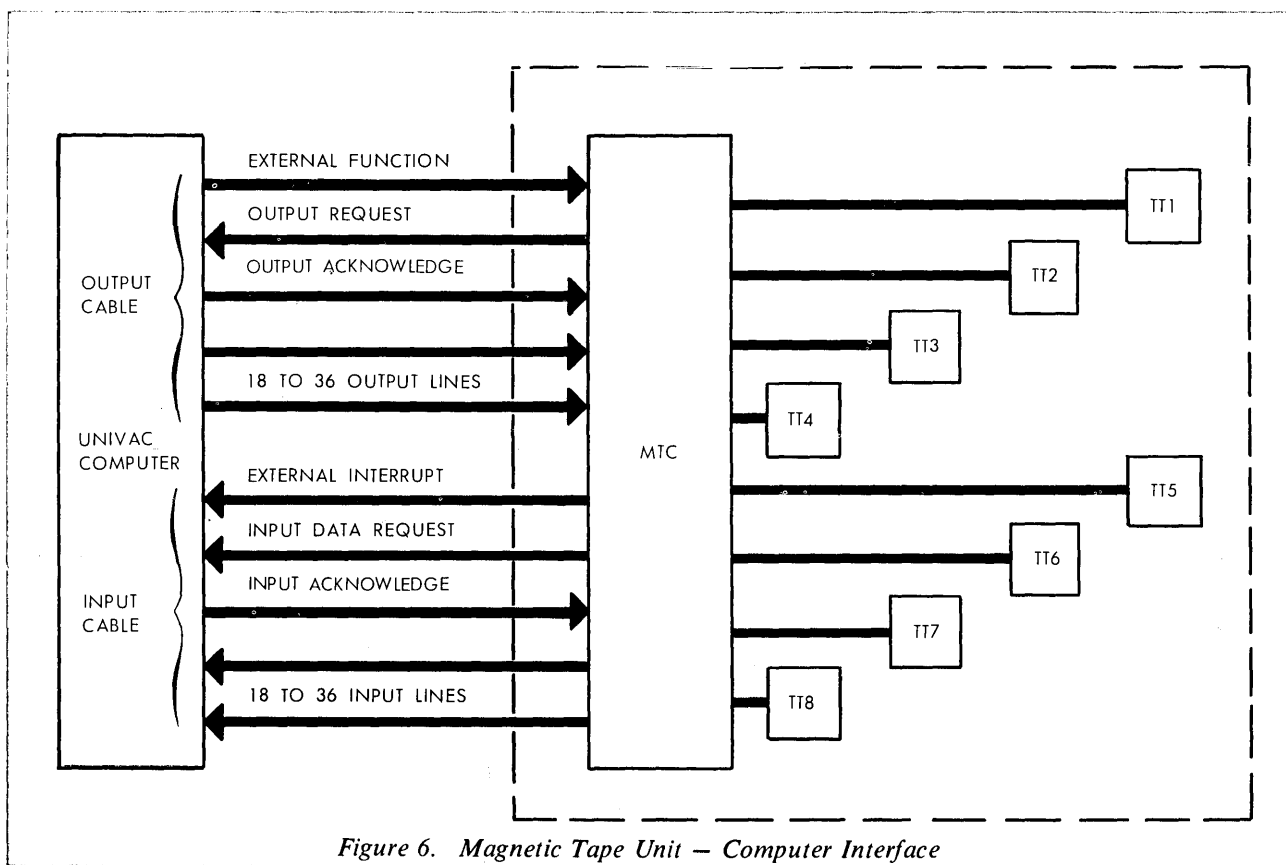
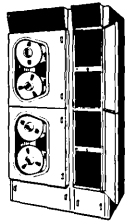
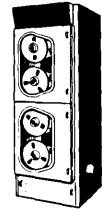

Figure 6. Magnetic Tape Unit - Computer Interface



BASIC MAGNETIC TAPE UNIT



ADD-ON UNIT

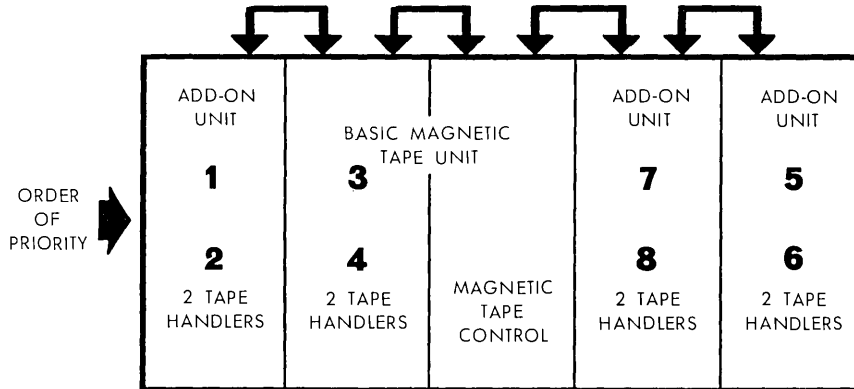
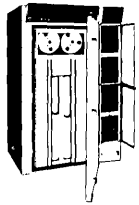
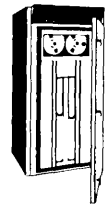

Figure 7. Type 1540 Magnetic Tape System (Maximum Configuration)



BASIC MAGNETIC TAPE UNIT



ADD-ON UNIT

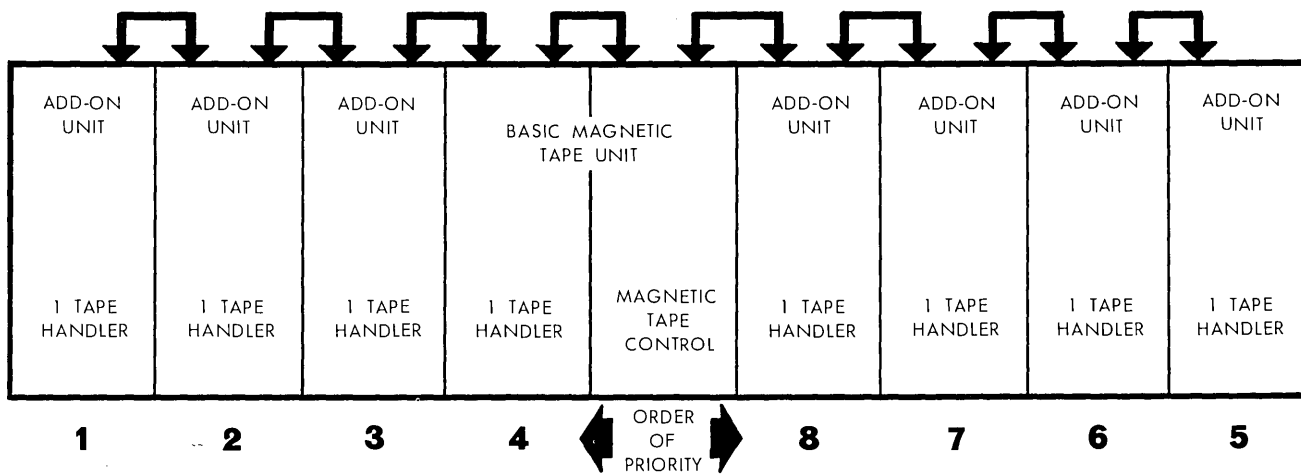

Figure 8. Type 1541 Magnetic Tape System (Maximum Configuration)

Tape Markers

The Load Point and End of Tape markers are adhesive-coated strips of aluminum one inch by 3/16 inch, placed on the base (uncoated) side of the tape with the one-inch dimension parallel to the tape edge. (See Figure 9 for Tape Format.) The Load Point marker is placed 1/32 inch from track "0" or outside edge of the tape and at least ten feet from the beginning of the tape. The End of Tape marker is placed 1/32 inch from track "6" or inside of the tape and at least 14 feet from the end of the tape. The markers are detected by reflective photoelectric sensors.

Status Word and Interrupt (Status Interrupt)

The computer program is interrupted after completion of every operation performed by the Magnetic Tape Control, except Master Clear and Transport Address Selection. The Magnetic Tape Control places a Status Word on the channel input lines and a signal on the channel External Interrupt line. The bit structure of the Status Word (see Figure 10)

enables the computer program to determine the status of the Magnetic Tape Unit and whether or not the requested operation was completed successfully. Errors encountered during a requested operation, as well as the physical status of the Magnetic Tape Unit, are indicated in the Status Word. The term "Status Interrupt" is used to express this philosophy since the computer program is interrupted and the status of the Magnetic Tape Unit and the encountered errors are designated in the Status Word. Any such Interrupt sent to the computer must be acknowledged by the computer before another External Function with an Instruction Word will be recognized by the Magnetic Tape Control. Successful completion of an operation will contain no error indications, but other indications of tape status may be present.

The Status Word requires a word of at least 15 bits. If the computer accepts words larger than 15 bits, the information in the next higher order bits beginning at bit 15 is not interpreted. The following paragraphs present the detailed explanation of each bit of the Status Word.

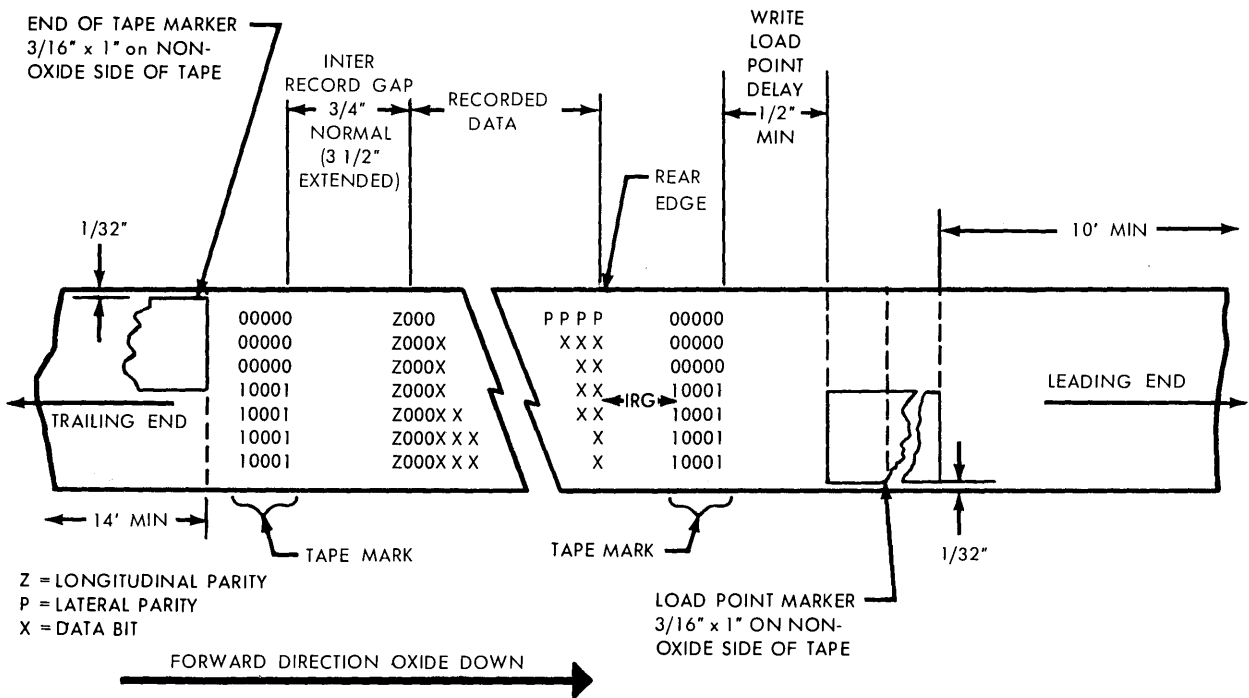

Figure 9. Tape Format

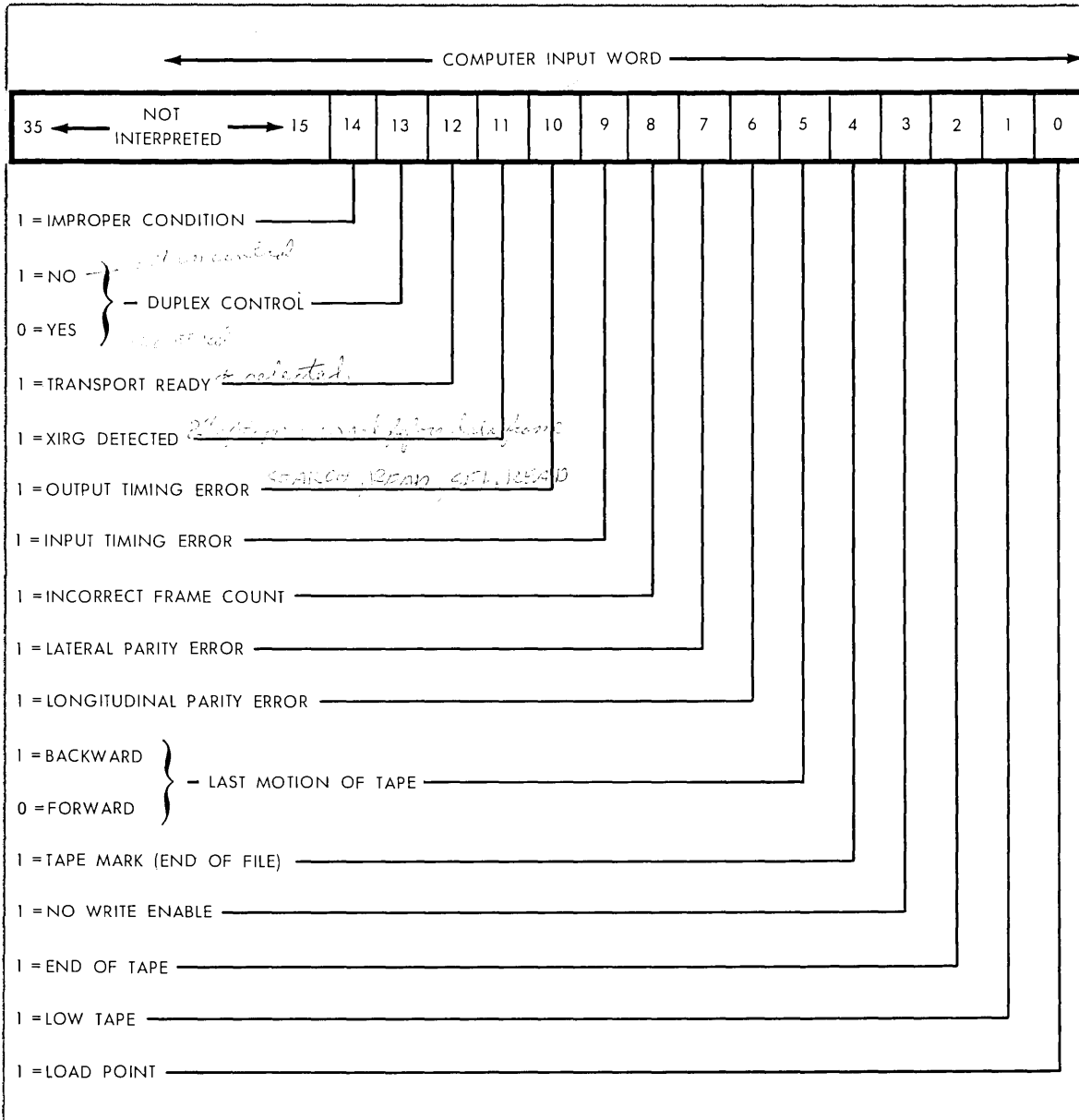
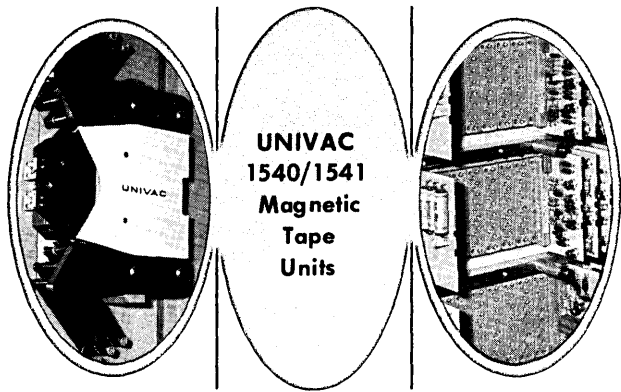

Figure 10. Magnetic Tape Unit — Status Word Format



IMPROPER CONDITION (Bit 14 = 1)

An Improper Condition will occur whenever:

- Selected tape transport is not in automatic condition. A tape transport not in automatic condition implies one of the following situations:
 - Tape transport was manually removed from automatic.
 - Tape transport not in ready condition for one of the following reasons:
 - Power off
 - Tape broken
 - Lamp burnout
 - Tape load was not accomplished when tape was mounted.
- (This situation also causes the Transport Ready Bit in the Status Word to be cleared.)
- No tape transport is selected when one is required.
- A forward command is sent to a tape transport whose tape is positioned at End of Tape.
- A reverse command, other than a Rewind Operation, is sent to a tape transport whose tape is positioned at Load Point.
- A WRITE instruction is issued to a tape transport that has NO Write Enable. (This situation also causes the No Write Enable bit in the Status Word to be set.) When the computer has been notified of an Improper Condition, the computer program may then refrain from issuing further External Function commands to the tape system to allow visual inspection of the trouble and operator interven-

tion to overcome the difficulty, or it may issue another External Function command. An incoming External Function command to the tape system clears the Improper Condition indication.

DUPLEX CONTROL (Bit 13; 0 = In Control, 1 = Not In Control)

- The status of the duplexer is indicated by bit 13 of the Status Word and is sent to one of the two computers depending on the action initiated.
- The condition Not In Control (bit 13 = 1) is sent to the issuing computer when a word is transmitted by that computer while the duplexer is not in the proper position.
- The condition Not In Control (bit 13 = 1) is sent to the nonissuing computer when that computer loses control as a result of a Demand Duplex Control issued by the other computer.
- The condition In Control (bit 13 = 0) is sent to the issuing computer when a Request Duplex Control is issued and the duplexer is transferred to the control of that computer.

TRANSPORT READY (Bit 12 = 1)

The Transport Ready bit indicates that the last-addressed tape transport is in a ready condition as follows:

- Power is on
- Magnetic tape reel is mounted and tape is properly loaded
- Tape marker detector lamp is operating.

XIRG DETECTED (Bit 11 = 1)

The XIRG Detected bit indicates that an Extended Interrecord Gap (3-1/2 inches between records) has been sensed during tape read. Tape movement continues until the next record is read.

OUTPUT TIMING ERROR (Bit 10 = 1)

If the computer issued a Write Instruction to the Magnetic Tape Control and did not transfer the

first output data word, or transferred a requested data word too late to be written in its proper place and before the Interrupt is sent to the computer following End of Record, an Output Timing Error occurs. This word transfer time is related to Format and Density as shown in Table 1. An Output Timing Error can occur during search or selective read operations if the Magnetic Tape Control does not receive a Search Key or Selective Read Code before assembling the first word. The time requirement may be as short as 2-1/2 milliseconds from the time the Instruction Word is received by the Magnetic Tape Control until the Search Key, Selective Read Code, or the first data word must be received.

INPUT TIMING ERROR (Bit 09 = 1)

If the computer issued a Read Instruction and failed to accept a word placed on the input cable by the Magnetic Tape Control before the next word was to be placed on the input cable, an Input Timing Error occurs. This error indicates that the computer lost one or more words of the last record since data transmission to the computer ceases for the remainder of the record. The tape continues to

move to the End of Record at which time the Magnetic Tape Control sends the Status Word indicating the error with an Interrupt to the computer.

INCORRECT FRAME COUNT (Bit 08 = 1)

An improper modulus specified or some frames lost causes an Incorrect Frame Count Error. This may be caused by one or more of the following:

- There were not enough frames in the record to complete an integral number of computer words;
- One or more characters were not properly read or recorded;
- Bad spots on the tape caused characters to be lost;
- Reading the record with the wrong Format (for example, Reading Mod 4 with a tape record in Mod 5).

Longitudinal Parity Error can be expected with Incorrect Frame Count Error except during reading with the wrong modulus.

TABLE 1. WORD ASSEMBLY TIME (Microseconds)

FORMAT		UNIVAC 1540			UNIVAC 1541		
MODULUS	CHARACTER	200 fpi	556 fpi	800 fpi*	200 fpi	556 fpi	800 fpi*
3	Biocidal	125	45	31.2	100	36	25
4	Biocidal	167	60	41.6	133.3	48	33.3
5	Biocidal	208	75	52.0	166.6	59.9	41.6
6	Biocidal	250	90	62.4	200	72	50
3	Octal	250	90	62.4	200	72	50
4	Octal	334	120	83.2	266.6	96	66.6
5	Octal	416	150	104.0	333.2	119.8	83.2
6	Octal	500	180	124.8	400	144	100

*Refer to individual computer technical description brochures for interface compatibility definition.

LATERAL PARITY ERROR (Bit 07 = 1)

During a writing process, a parity bit is added to each six-bit character according to a format specified and the seven bits are recorded as one frame. If the Magnetic Tape Control detects a frame whose Lateral Parity does not agree with that specified by the Format, during any read type operation or during the post-write check of the recording operation, a Lateral Parity Error occurs.

LONGITUDINAL PARITY ERROR (Bit 06 = 1)

During a writing process, a longitudinal even parity bit is generated by the Magnetic Tape Control for each tape channel and recorded after the last frame of the record. If the Magnetic Tape Control detects an error in this parity during any read type operation or during the post-write check of the recording operation, a Longitudinal Parity Error occurs. If a Frame Count Error ever occurs, the Longitudinal Parity Error usually occurs. Both would be indicated in the Status Word.

LAST TAPE MOTION (Bit 05; 1 = Backward, 0 = Forward)

Any Status Word with Interrupt sent to the computer at the completion of an operation will indicate the direction of the last tape motion. The program can determine whether the tape is positioned at the beginning or the end of the record.

TAPE MARK (Bit 04 = 1)

A recorded Tape Mark (refer to Write Tape Mark) separates Files of information on the tape. Any Read, Space File, Search File or Back Read operation that is limited to a File and the post-write check of the Write Tape Mark operation, will indicate a Tape Mark in the Status Word.

NO WRITE ENABLE (Bit 03 = 1)

When a Write operation is attempted on a selected transport that has its Write Enable cleared or the Write Enable Ring is not inserted in the tape reel, the No Write Enable is indicated in the Status Word.

END OF TAPE (Bit 02 = 1)

When the End of Tape reflective marker is sensed by the Magnetic Tape Unit, a 1/2 second "Time-Out" begins after which no forward movement of tape is possible. Reverse direction tape motion past the tape marker is possible. The End of Tape indication will appear in the Status Word. If forward tape motion is reinitiated, the marker is sensed again and after the 1/2 second "Time-Out" the forward tape motion is stopped.

LOW TAPE (Bit 01 = 1)

A tape supply detector has sensed less than 100 feet of tape remaining on the selected transport reel. The Magnetic Tape Control will indicate a Low Tape any time a Status Word is sent to the computer with the tape positioned within 100 feet of End of Tape.

LOAD POINT (Bit 00 = 1)

Recording on a tape begins at Load Point (a reflective tape marker placed at least ten feet from the physical beginning of the tape). The Write-Load Point delay allows for a gap of at least 1/2-inch beyond the Load Point marker (in the forward direction) before the first record may be written. The Magnetic Tape Control will indicate Load Point in the Status Word whenever an operation requesting backward motion of tape is attempted with the selected tape positioned at Load Point.

**EXTERNAL FUNCTION COMMANDS —
FUNCTION WORDS****MASTER CLEAR**

Operations and tape selections are requested by Function Words being sent to the Magnetic Tape Unit with an External Function from the computer. A Master Clear of the Magnetic Tape Unit is performed when a Demand Duplex Control Command is sensed by the Magnetic Tape Control. It differs from the other operations in these three respects:

- It may be performed at any time, even when Magnetic Tape Unit is BUSY;

- It has priority over all other operations in the Instruction Word; (see Figure 11)
- It does not result in a Status Interrupt to the issuing computer.

The Master Clear stops all tape motion (except a rewinding tape) and sets the Magnetic Tape Unit in the READY state. At any time after a Master Clear, the Magnetic Tape Control will accept another External Function. Since this function is not considered a normal operation, its use should be restricted to times when the Magnetic Tape Unit is believed to be in an illogical state or when its state cannot be determined. The Master Clear does not clear the Write Enable which is set manually. To clear the Write Enable, a form of "Clear Write Enable" instruction must be used.

INSTRUCTION WORD

Individual operations are performed by the Magnetic Tape Unit under direction of an Instruction Word. When the computer output word is transmitted with an External Function signal, it is sensed at the Magnetic Tape Control as a command. The operation to be performed, format and density, if required, and the transport selection address or reading bias are defined in the Instruction Word. The format for the Instruction Word is shown in Figure 11. The individual tape transport is selected by bits 05-00 of the Instruction Word. The Magnetic Tape Unit consists of a maximum of eight tape transports each of which must be assigned a logical number by the operator on the transport selection switch provided for each tape handler.

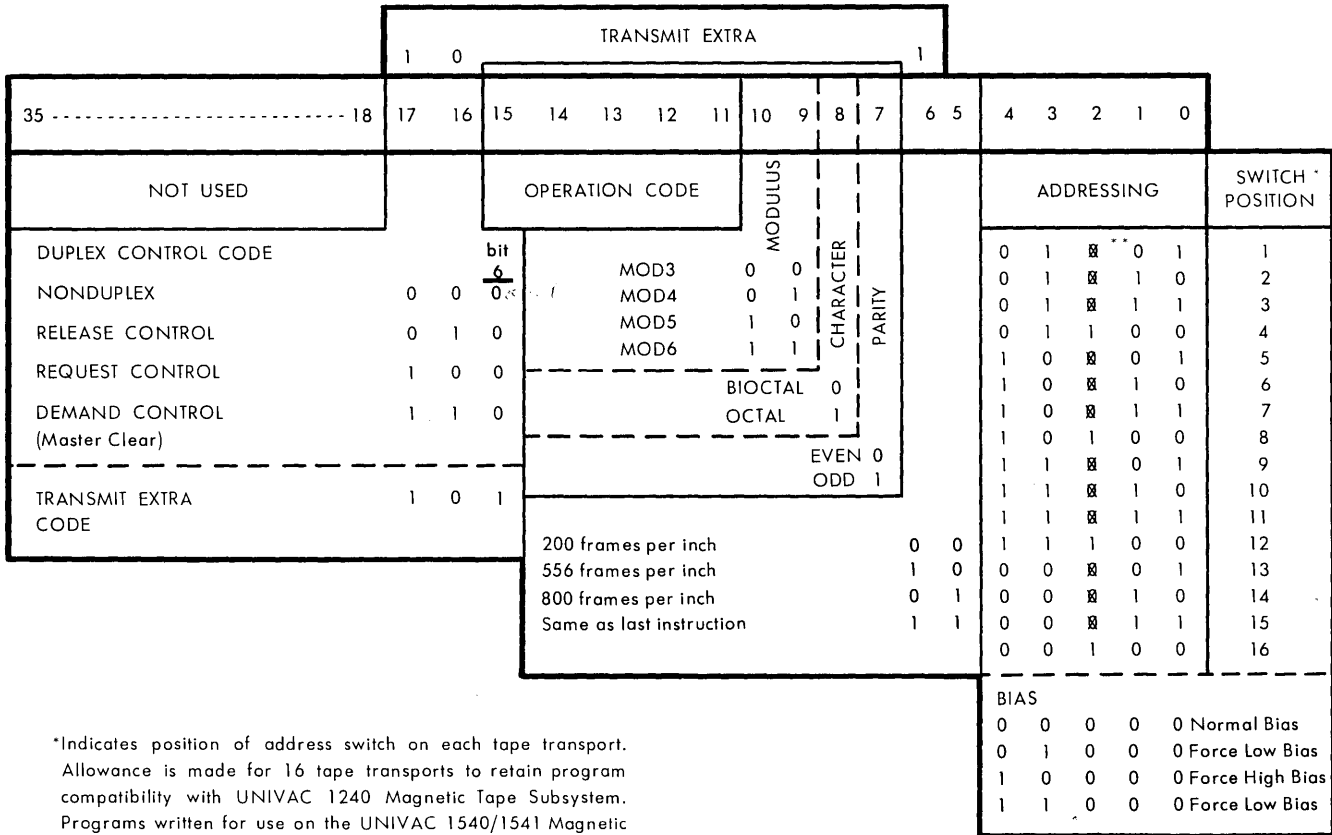

*Indicates position of address switch on each tape transport. Allowance is made for 16 tape transports to retain program compatibility with UNIVAC 1240 Magnetic Tape Subsystem. Programs written for use on the UNIVAC 1540/1541 Magnetic Tape Subsystems address only tape transport positions 1 through 8.

**X = zero or one.

Figure 11. External Function Word Format

Format (Bits 10-7)

The Format portion of the Instruction Word contains Modulus, Character, and Parity designators. A complete Format selection must be included in all Instruction Words which request a reading or recording operation with the exception that Modulus may be ignored in the Write Tape Mark Instruction. The Modulus designator and the Character designator direct the Magnetic Tape Control in the assembly and disassembly of computer words from or to tape frames.

Character Designator (Bit 8), 1 Selects Octal; 0 Selects Bi-octal

Bi-octal or octal (redundant) format is specified in operations requiring reading or writing. The bi-octal

format disassembles 18-, 24-, 30-, or 36-bit computer words into 3, 4, 5, or 6 six-bit-plus-parity tape frames, respectively, during recording (vice versa for reading). (See Figure 12.) The octal format disassembles 18-, 24-, 30-, or 36-bit computer words into 6, 8, 10, or 12 tape frames, respectively, during recording (vice versa for reading). Tape Channels 3, 4, and 5 contain the same information as Channels 0, 1, and 2, respectively, in each frame, except when Channels 0, 1, and 2 contain zeros, Channels 3, 4, and 5 contain ones. Odd parity is selected by the Magnetic Tape Control when writing or reading Octal Characters. The redundant recording in octal format adds to the reliability (see Figure 13). For compatible tapes, data must be recorded in Bi-octal format.

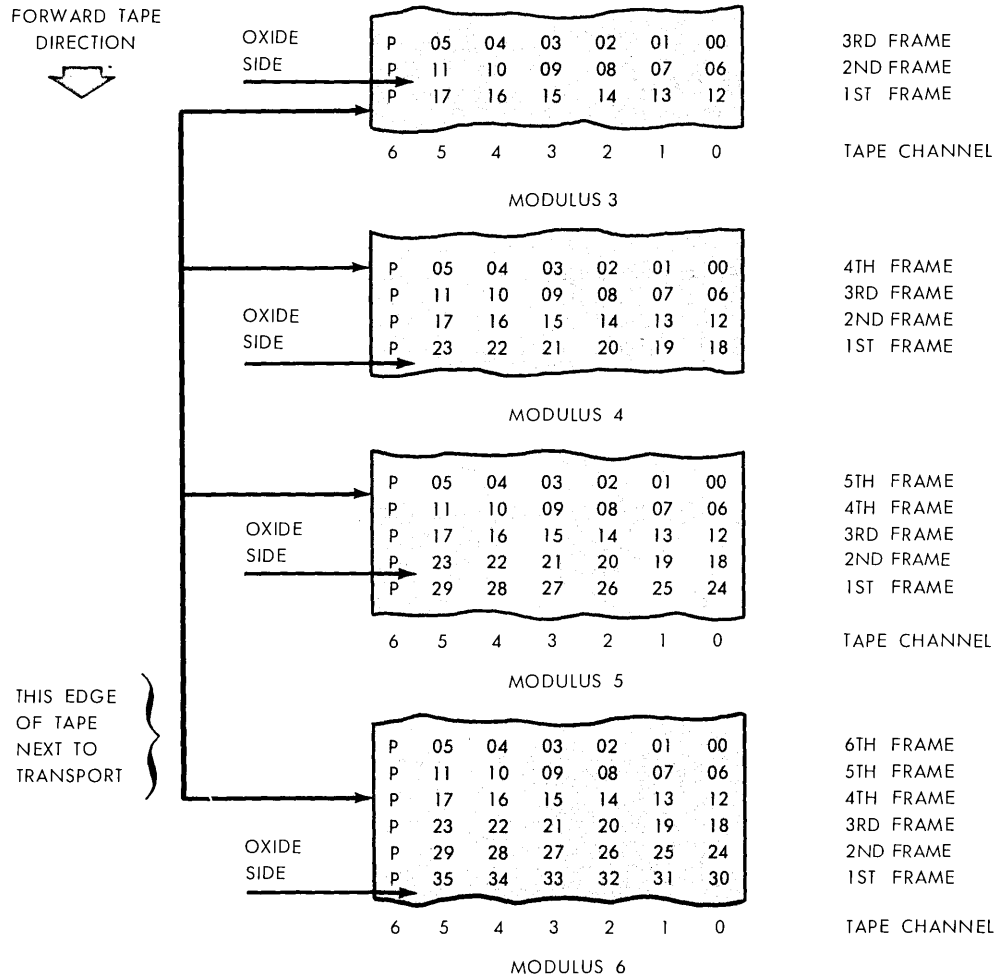

Figure 12. Bi-octal Tape Format

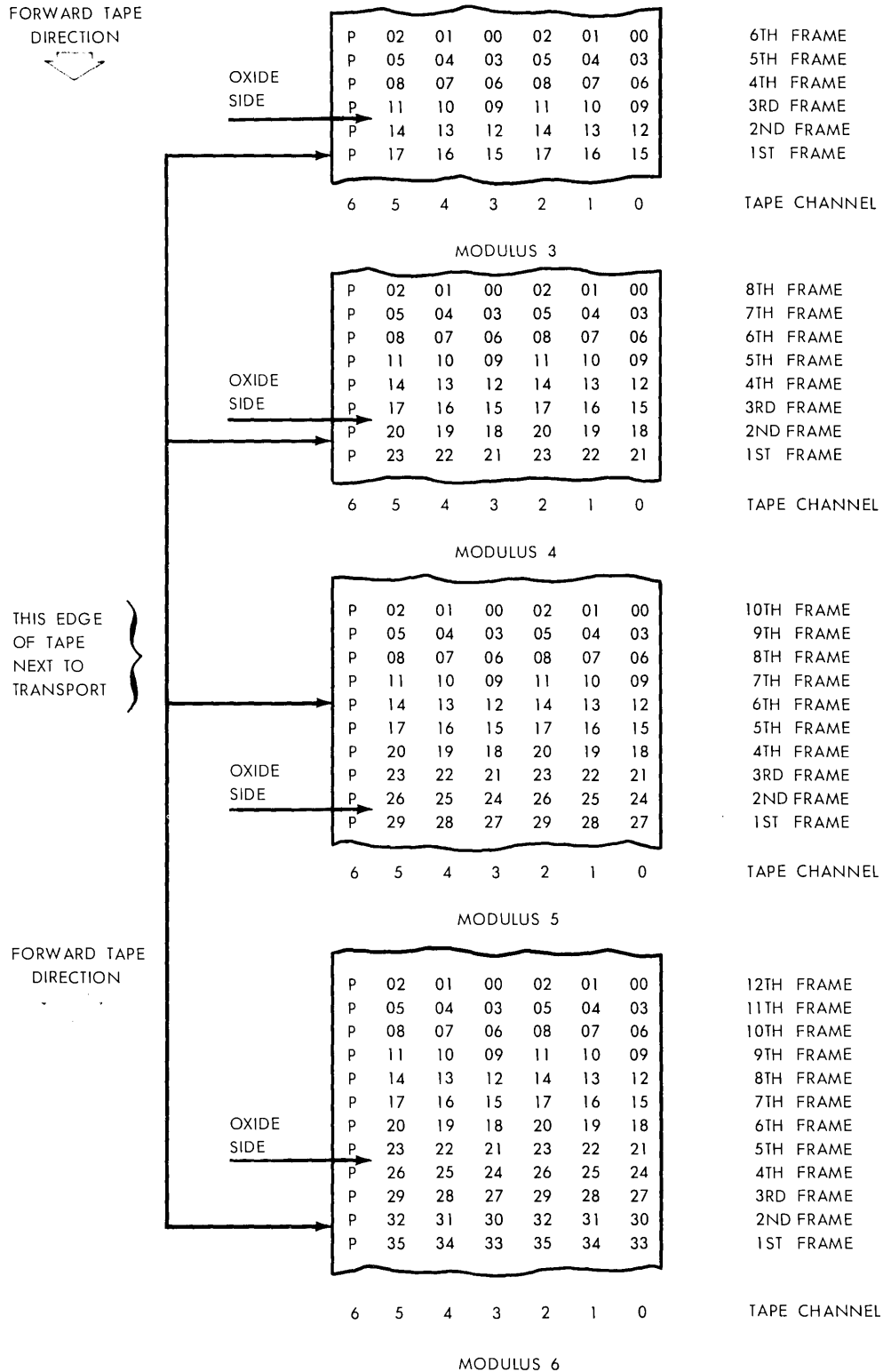

Figure 13. Octal Tape Format

The Modulus Specifies the Length of the Computer Word To Be Recorded on Tape or Read from the Tape (Refer to Table 2)

Modulus 3 (designator bits 10 and 09 = 00) – An 18-bit computer word is disassembled and recorded as three tape frames of Bi-octal Character format or six tape frames of Octal Character format. If a computer delivers a word larger than 18 bits for recording, the Magnetic Tape Control will record the lower order 18 bits of the word on the tape and discard the remaining high order bits. During Mod 3 reading operations, three tape frames are assembled as an 18-bit computer word for Bi-octal Character format, or six tape frames are assembled as an 18-bit computer word in Octal Character format. If the computer word size is larger than 18 bits, the frames are assembled in the lower order 18 bits and zeros are placed in remaining high order bits (see Figures 12 and 13).

Modulus 4 (designator bits 10 and 09 = 01) – A 24-bit computer word is disassembled and recorded as four tape frames of Bi-octal Character format or eight tape frames of Octal Character format. If a computer delivers a word larger than 24 bits for recording, the Magnetic Tape Control will record the lower order 24 bits of the word on the tape and discard the remaining high order bits. During Mod 4 reading operations, four tape frames are assembled as a 24-bit computer word for Bi-octal Character format or eight tape frames are assembled as a 24-bit computer word for Octal Character format. If the computer word size is larger than 24 bits, the frames are assembled in the lower order 24 bits and zeros are placed in remaining high order bits (see Figures 12 and 13).

Modulus 5 (designator bits 10 and 09 = 10) – A 30-bit computer word is disassembled and recorded as five tape frames of Bi-octal Character format or ten tape frames of Octal Character format. If a computer delivers a word larger than 30 bits for recording, the Magnetic Tape Control will record the lower order 30 bits of the word on the tape and discard the remaining high order bits. During Mod 5 reading operations, five tape frames are assembled as a 30-bit computer word for Bi-octal Character format or ten tape frames are assembled as a 30-bit computer word for Octal Character format. If the computer word size is larger than 30 bits, the frames are assembled in the lower order 30 bits and zeros

are placed in remaining high order bits (see Figures 12 and 13).

Modulus 6 (designator bits 10 and 09 = 11) – A 36-bit computer word is disassembled and recorded as six tape frames of Bi-octal Character format or twelve tape frames of Octal Character format. During Mod 6 reading operations, six tape frames are assembled as a 36-bit computer word for Bi-octal Character format or twelve tape frames are assembled as a 36-bit computer word for Octal Character format. (See Figures 12 and 13.)

Parity Designator (Bit 7), 1 Selects Odd; 0 Selects Even

Either Odd (the total number of ones in a frame is odd) or Even (the total number of ones in a frame is even) Lateral Parity may be specified in the Instruction Word for Bi-octal Character writing and reading operations; however, Odd Parity is selected by the Magnetic Tape Control for the Octal Character writing and reading operations. For compatible tapes, Odd Parity is chosen for Binary data coded and Even Parity is chosen for Binary Coded Decimal (BCD) data.

Density Designator (Bits 6 and 5)

00 Selects 200 fpi; 10 selects 555 fpi; 01 selects 800 fpi; and 11 selects same density as last instruction
At low density, data are recorded at 200 frames per inch, at medium density 555.5 frames per inch, and at high density 800 frames per inch. Density must be specified in Instruction Words requesting reading or writing operations. Refer to Table 1 for word assembly and disassembly time.

Operation Code

The Operation Code is located in Bits 15-11 of the Instruction Word. Legal operation codes exist for the six basic operations and for combinations of these operations. The six basic operations are Duplex Selection, Read, Search, Write, Space File, and Rewind. Operation Codes using any basic operation (except Rewind) must be supplemented by Format and Density codes placed in bits 10-07 and bits 06 and 05 respectively, of the Instruction Word. Table 3 is a listing of the Operation codes and Figure 11 shows the structure of the entire instruction word.

Read Operations

The selected transport moves tape at 120 inches per

TABLE 2 CHART SHOWING THE EFFECTS OF VARIOUS UNIVAC COMPUTERS OPERATING WITH THE UNIVAC 1540 OR 1541 MAGNETIC TAPE SUBSYSTEMS

	MOD 3 BCD WRITE	MOD 4 BCD WRITE	MOD 5 BCD WRITE	MOD 6 BCD WRITE
UNIVAC 1218 and 1219 Single Channel (One 18-Bit Word Is Output/Request)	For each 18-bit word received, the 1540 or 1541 writes 3 frames on the tape. Mod 3 is recommended for single channel operation.	For each 18-bit word received, the 1540 or 1541 writes 4 frames on the tape: 1 frame of zeros followed by 3 data frames.	For each 18-bit word received, the 1540 or 1541 writes 5 frames on the tape: 2 frames of zeros followed by 3 data frames.	For each 18-bit word received, the 1540 or 1541 writes 6 frames on the tape: 3 frames of zeros followed by 3 data frames.
UNIVAC 1218 and 1219 Dual Channel (One 36-Bit Word Is Output/Request)	For each 36-bit word received, the 1540 or 1541 writes 3 frames on the tape. Since only the 18 LSB are written the 18 MSB are "lost".	For each 36-bit word received, the 1540 or 1541 writes 4 frames on the tape. Since only the 24 LSB are written the 12 MSB are "lost".	For each 36-bit word received, the 1540 or 1541 writes 5 frames on the tape. Since only the 30 LSB are written the 6 MSB are "lost". Mod 5 is commonly used when preparing tapes for the 30-bit computers (CP-642B, UNIVAC 1206 or 1230).	For each 36-bit word received, the 1540 or 1541 writes 6 frames on the tape. Mod 6 is recommended for dual channel operation.
UNIVAC 1206, 1212, CP-642B, or 1230 (One 30-Bit Word Is Output/Request)	For each 30-bit word received, the 1540 or 1541 writes 3 frames on the tape. Since only the 18 LSB are written the 12 MSB are "lost".	For each 30-bit word received, the 1540 or 1541 writes 4 frames on the tape. Since only the 24 LSB are written the 6 MSB are "lost".	For each 30-bit word received, the 1540 or 1541 writes 5 frames on the tape. Mod 5 is recommended for operation with CP-642B, 1206, or 1230 Computers.	For each 30-bit word received, the 1540 or 1541 writes 6 frames on the tape: 1 frame of zeros followed by 5 data frames. Mod 6 is commonly used when preparing tapes for 36-bit computers.

LSB — Least Significant Bits

MSB— Most Significant Bits

second (by the 1540) or 150 inches per second (by the 1541) in either direction and transfers seven bit frames (read from tape) to the Magnetic Tape Control. Parity, even or odd, as specified in the Format is checked for each frame of the record. The six data bits are assembled into 18-, 24-, 30-, or 36-bit computer words according to the Modulus and Character designator of the Format. The assembled computer word is placed on the data lines of the computer input cable and the Input Request (IR) line is set. The computer samples the data lines at its convenience and sets the Input Acknowledge line to the Magnetic Tape Control. The tape continues to move and new words are being assembled until the End of Record (Interrecord Gap) is reached.

The computer must sample the input lines and acknowledge each IR within a specified time (governed by Density, Character, and Modulus - Table 1) to prevent loss of one or more words in the record. If the computer fails to sample the input lines and acknowledge the IR within the allotted time during any type of Read Operation, an Input Timing Error will occur and the Magnetic Tape Control will cease to transfer data to the computer for the remainder of the record. Following the detection of the End of Record the Magnetic Tape Control will set an Input Timing Error Status Word on the input lines and interrupt the computer program by setting the External Interrupt (EI) line on that channel. When the computer acknowledges the

Interrupt, the Magnetic Tape Unit becomes READY.

In all types of Read Operations, Format and Density selections must be made in each instruction.

Read-Forward

The selected transport will read one record according to the Format stated and check each frame for

parity. If a parity error is detected, the Magnetic Tape Control will continue to transfer data to the computer for the remainder of that record. After sensing the End of Record, the Magnetic Tape Control will send a Status Word to the computer with a signal on the External Interrupt line. This Status Word will contain Magnetic Tape Unit status and any or all error indications encountered during the reading of the record.

TABLE 3. OPERATION CODES

OPERATION CODE	OPERATION
00000	Read (Read Forward) <i>(ignore error halt)</i>
00001	Read: Selective (Selective Read-Forward)
00010	Read: Modified Stop <i>(ignore error halt)</i>
00011	Space File
00100	Search Type I
00101	Search Type II
00110	Search File Type I
00111	Search File Type II
01000	Write
01001	Write XIRG
01010	Write Ignore Error Halt
01011	Write XIRG, Ignore Error Halt
01100	Write Modified Stop
01101	Write Edit
01110	Write Tape Mark <i>— always write 173</i>
01111	Write Tape Mark, XIRG <i>" " "</i>
10000	Backread (Read Backward) <i>(ignore error halt) (always write)</i>
10001	Backread Selective (Selective Read-Backward)
10010	Backread Modified Stop <i>(ignore error halt) (stop write in)</i>
10011	Backspace File
10100	Backsearch Type I
10101	Backsearch Type II
10110	Backsearch File Type I
10111	Backsearch File Type II
11000	Rewind
11001	Rewind, Clear Write Enable
11010	Rewind
11011	Rewind, Clear Write Enable
11100	Rewind-Read
11101	Rewind-Read, Clear Write Enable
11110	Rewind-Read
11111	Request Transport-Status

may use same search key as for forward read. if both words is same request word

Bits 17, 16 and 6 = 1, 0 and 1, respectively, Transmit Extra

Read-Backward

The selected transport will read one record backward to the next Interrecord Gap (back one record) according to Format and Density stated in the Instruction Word. Lateral and longitudinal parity will be checked while reading. If an error is detected during backward motion, the reading operation will continue and the Status Word, upon detection of Interrecord Gap, will contain the Magnetic Tape Unit status and the error indication. Characters will be assembled in each computer word in the same position as in a forward read. Computer words, however, will be transmitted in reverse order.

Read-Modified Stop

The selected transport will read one record according to the Format stated and will check each frame for parity. At the completion of the read, the magnetic tape will be stopped farther in the IRG. The Status Word sent to the computer after detection of End of Record will contain Magnetic Tape Unit status and any or all error indications including parity error.

Selective Read-Forward/Backward

The selected transport will read one record according to the Format stated and check each frame for parity. Words are read and assembled as in a Read-Forward/Backward. A Selective Read Code, contained in the least significant six bits (05-00) of a computer word, is sent by a single word output buffer to the tape unit before it can read and assemble one word. Should this word be formed before the Selective Read Code is transmitted, an Output Timing Error is detected. The Magnetic Tape Control will compare the least significant six bits (05-00) of each assembled computer word with the Selective Read Code. If the comparison is negative, the word will be discarded and the reading continued. A positive comparison causes the word to be transmitted to the computer. However, if a parity error is detected in either case, further transfer of data ceases for the remainder of the record. The Status Word sent to the computer after detection of End of Record will contain Magnetic Tape Unit status and any or all error indications.

Write Operation – General Information

When the Magnetic Tape Control senses a WRITE function, the selected transport moves the tape forward and records the Interrecord Gap. A signal

is placed on the computer Output Request (OR) line. The computer, at its convenience, responds with a word on the data lines and places a signal on the channel Output Acknowledge (OA) line. The Magnetic Tape Control recognizes the OA, samples the data lines and removes the Output Request. The word is transferred to the disassembly register and another Output Request is issued. The Magnetic Tape Control disassembles each word according to the modulus selected in the Write Function Word, generates frame parity, and transfers the seven bits to the transport for recording on tape according to the density selected. As the recording frame passes over the read head it is checked for parity. If a parity error is detected, the Magnetic Tape Control stops the Write operation and the tape motion. A Status Word, indicating an error in recording, is placed on the channel input lines with a signal on the External Interrupt line. If no error occurs during recording, the process continues until the computer no longer acknowledges the Output Request within the time allotted for another word to be disassembled and written. This time is dependent on Format and Density (refer to Table 1). When the computer does not respond within the allotted time, the End of Write is assumed by the Magnetic Tape Control. Longitudinal parity is written and the recording process is terminated. Tape motion is stopped after a portion of the Interrecord Gap is written on the tape. The Magnetic Tape Control removes the Output Request and places a Status Word, indicating successful completion of the Write, on the input lines and sets the External Interrupt line. When the computer acknowledges the Interrupt, the Magnetic Tape Subsystem becomes IDLE. If the computer acknowledges the Output Request after the allotted time but before the interrupt is sent, the Magnetic Tape Control interprets the action as an Output Timing Error and notifies the computer in the Status Word.

NOTE: The normal Interrecord Gap is approximately 3/4 inch in length and the Extended Interrecord Gap is approximately 3-1/2 inches in length.

Write

The selected transport will write on the tape according to the Format and Density stated in the Function Word. If no recording error is detected the normal operation continues until the computer no

longer transfers data, at which time longitudinal parity is written and the Status Word with Interrupt is sent to the computer.

Write-Ignore Error Halt

The selected transport will write on the tape according to the Format and Density stated in the Function Word, but the Magnetic Tape Control will not stop the writing process if lateral parity errors are detected as the recorded frames pass over the read head. The Status Word sent to the computer with Interrupt after completion will contain Magnetic Tape Unit Status and any or all errors encountered.

Write-Extended Interrecord Gap (XIRG)

The selected transport will record an Extended Interrecord Gap of 3-1/2 inches instead of the normal 3/4 inch IRG preceding a normal Write portion of the operation. If no data are transferred from the computer for recording, the Extended Interrecord Gap will be present on the tape and an Output Timing Error will occur. The Status Word sent to the computer after completion will contain Magnetic Tape Unit status and any or all error indications detected as in a normal Write operation.

NOTE: Special Length Interrecord Gap.

Under program control, Interrecord Gaps other than the fixed 3/4 inch and 3-1/2 inch lengths may be written. Successive 3/4 or 3-1/2 inch gaps may be written by issuing the appropriate Write functions without initiating output buffers at the computer. The program must be prepared to handle the Output Timing Error that will be indicated in the Interrupt Status Word following each Write operation performed in this manner.

Write Tape Mark

The selected transport will write a fixed format Tape Mark. The Tape Mark is a special record having ones in only the 0-, 1-, 2-, and 3-bit positions of the first frame, followed by three frames of zeros and one frame of longitudinal parity. The entire record is written by the Magnetic Tape Control upon receiving the Instruction Word. Format selection can be ignored. To be compatible with other tape systems, the Tape Mark must be exactly as specified above. A Status Word with Interrupt is sent to the computer after completion of the Write Tape Mark operation.

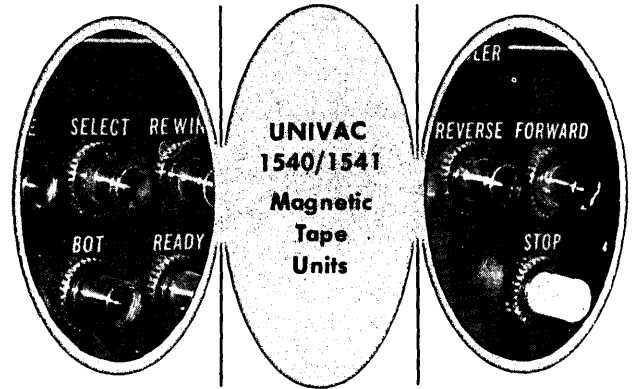

Space File-Forward/Backward

The selected transport will move the tape in the selected direction to the IRG (beyond the next tape mark). The tape is properly positioned in the IRG for reading or writing. Format and Density must be stated in the Instruction Word since parity will be checked during the tape motion. Any error detected and Magnetic Tape Unit status will be indicated in the Status Word sent to the computer with Interrupt after completion. If the tape is at Load Point at the time the Back Space or at End of Tape at the time the Space File instruction is given, an Improper Condition exists and will be noted in the Status Word.

Rewind

The selected transport will rewind the tape backward to the Load Point at rewind speed. The Status Word with Interrupt is sent to the computer after the Magnetic Tape Control initiates the Rewind and not at the completion of the Rewind. If the tape is at Load Point when the instruction is received, no tape motion or Improper Condition will result, but the Status Word will indicate Load Point. This provides a method of testing for completion of the Rewind operation.

Multifunction Operations (General Information)

Multifunction Operations consist of combinations of basic operations of the Magnetic Tape Unit, and can be performed in response to the one Instruction Word from the computer. Examples are the Search operations which combine the features of a Read with the ability to do a search on the first word of records, compare these words against an Identifier (Search Key) Word, and read on a "Find". Other Multifunction Operations combine a Read with a Rewind operation. Combinations of

functions such as these save on computer instructions, and provide some capabilities that cannot be achieved by using the basic operations one at a time.

Search (Type I and Type II – Forward/Backward)

The Search Operation combines the features of Read Forward/Backward and a Search. The selected tape transport will read records from the tape either forward or backward and compare the first word* of each tape record with a Search Key (Identifier Word) which is transmitted from the computer to the Magnetic Tape Unit by an output buffer of one word. When a compare is affirmative, that "FIND" record is transmitted to the computer as in a Read Forward/Backward.

Tape motion is started upon receipt of the Instruction Word. If the Magnetic Tape Unit does not receive the Search Key from the computer before it starts reading the record, an Output Timing Error will occur. This reading start time may be as short as two and one-half milliseconds. The Search operation will be terminated by the Magnetic Tape Unit when this timing error is detected by the Magnetic Tape Control. The Status Word containing Magnetic Tape Unit status and any or all error indications will be sent to the computer upon detecting the end of the record in which the error occurred. When the tape motion is stopped due to an error, the tape will be positioned in the Interrecord Gap before the record in which the error occurred if the motion is backward, and after the record if the motion is forward. A parity error can result from a faulty parity check on any frame of the tape being searched.

The ONES (Type I) compare is a bit by bit "greater-than-or-equal" compare. If the first word of the record is greater than or equal to the Search Key Identifier word, a "Find" is made. A six-bit example is shown below.

Search Key or Identifier Word	001101
FIND; if first word is	011101
FIND; if first word is	001101
NO FIND; if first word is	010101
NO FIND; if first word is	001100

The IDENTICAL (Type II) compare is an exact equal compare. The first word of the record must be exactly equal to the Search Key Identifier word to define the "FIND" record.

*In a forward Search, the first word encountered in each record is the first word of the record. In a backward Search, the first word encountered in each record is the last word of the record.

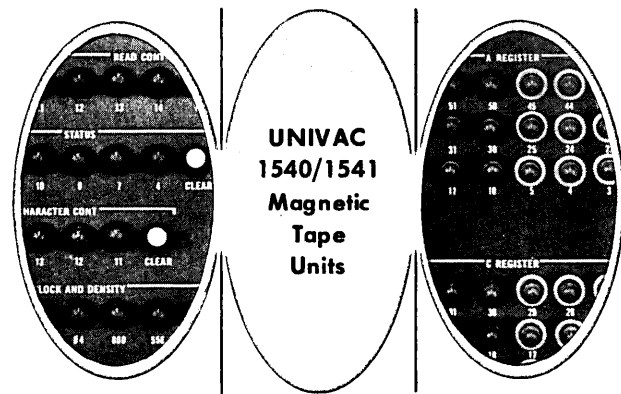

Search File Forward/Backward*

The Magnetic Tape Control will perform a Search Forward/Backward Type I or Type II as directed by operation code, on the selected tape transport, until it detects a "Find" or a "Tape Mark"**. If a Tape Mark is detected before a "Find", the Search File operation will be terminated and the Tape Mark Status Code will be present in the Status Word sent to the computer after detecting End of Record.

Space File Forward/Backward

The Magnetic Tape Control will cause the selected transport to move the tape in the specified direction to the Interrecord Gap beyond the next Tape Mark and will indicate Tape Mark in the Status Word sent to the computer detecting the End of Record (see Figure 14). Space File Forward will position a tape at A upon completion; Space File Backward will position the tape at B.

Rewind-Read

The selected transport will Rewind the tape to the Load Point at rewind speed and then perform a Normal Read of the first record according to the Format and Density stated in the Instruction Word. A Status Word containing Magnetic Tape Unit status and any or all errors will be sent to the computer with Interrupt after detecting the End of Record.

Rewind-Clear Write Enable

The selected transport will perform a normal Rewind of the tape to Load Point and will clear the Write Enable. This selected transport will no longer perform a Write function without manual intervention. The Status Interrupt will be presented upon initiation of the Rewind and not upon completion.

*A File is defined as one or more records separated by Tape Marks (see Figure 14).

**A Tape Mark is a special record on a tape placed there by the operation "Write Tape Mark" (see Figure 9).

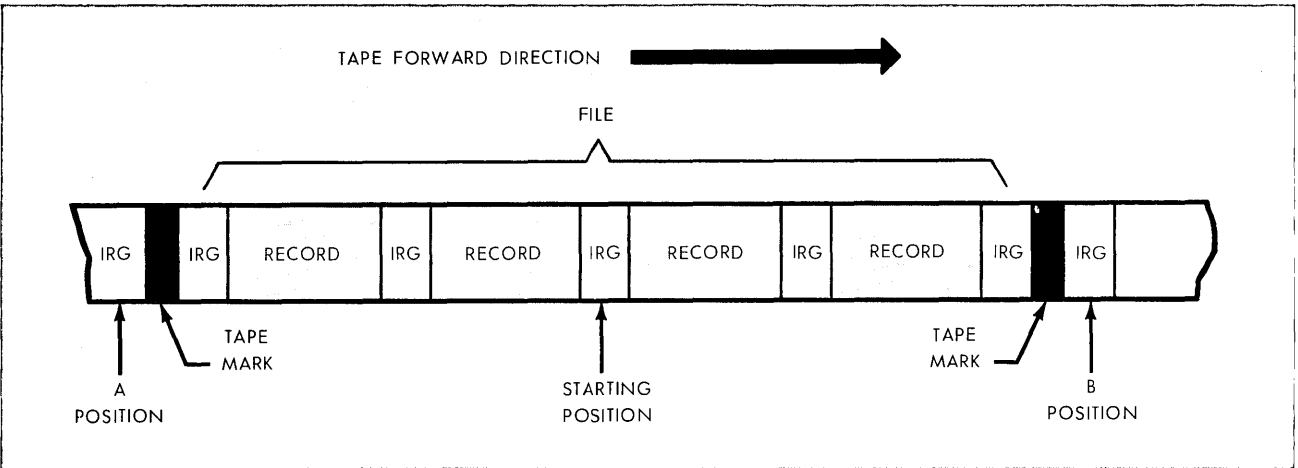

Figure 14. Magnetic Tape Unit – Tape File

Rewind-Read-Clear Write Enable

The selected transport will perform a Rewind-Clear Write Enable and then a Normal Read of the first record in the forward direction according to the Format stated in the Instruction Word. A Status Word containing Magnetic Tape Unit status and any or all errors will be sent to the computer with Interrupt after detecting the End of Record.

Request Transport Status

No tape operation is performed. The Magnetic Tape Unit sends a Status Word reflecting the status of the selected tape transport to the computer with Interrupt. However, when the "Not Ready" indication is obtained, the remainder of the Status Word may not be valid as it may have been derived from other handlers.

Transmit Extra (Bits 17, 16, and 6 = 1, 0, and 1, respectively)

The Transmit Extra Instruction Word is sent under program control in response to an Interrupt indicating a Frame Count Error at the end of a Read operation. All bits other than 17, 16, and 6 of the Instruction Word are ignored.

The Transmit Extra provides data recovery capabilities by the transmission of a single data word containing the extra characters of an incomplete computer word (6 bits per character) and denoting those character positions void of data. The extra characters will appear in the most significant character positions consistent with the specified modulus. Each bit of the least significant six will refer

to a character position in the word originating in the Magnetic Tape Control assembly register. All bits beyond the modulus limits will contain 0's. Whenever a bit in the least significant character is 1, the corresponding character in the assembly register is invalid; when a bit is 0, the corresponding character is valid (see Figure 15).

In the redundant format, the lack of one frame (character) would not allow the last frame to enter the assembly register and the frame would be lost. However, this would be a valid Improper Frame Count and would be accompanied by a Longitudinal Parity Error.

MAGNETIC TAPE UNIT — HIGH-SPEED PRINTER OFF-LINE CAPABILITY

Either Magnetic Tape Unit is capable of communicating directly with the UNIVAC 1469 High-Speed Printer for OFF-LINE operation. The Magnetic Tape Unit communicates with the High-Speed Printer Unit in the Request-Acknowledge mode. (The Magnetic Tape-Printer Interface is shown in Figure 16.)

Using terms based on Computer-Magnetic Tape Unit communication and Computer-High-Speed Printer communication in this discussion, the Output to the High-Speed Printer interface is connected to the Input from the Magnetic Tape Unit interface, i.e., the High-Speed Printer Output Request line is connected to the Magnetic Tape Unit Input

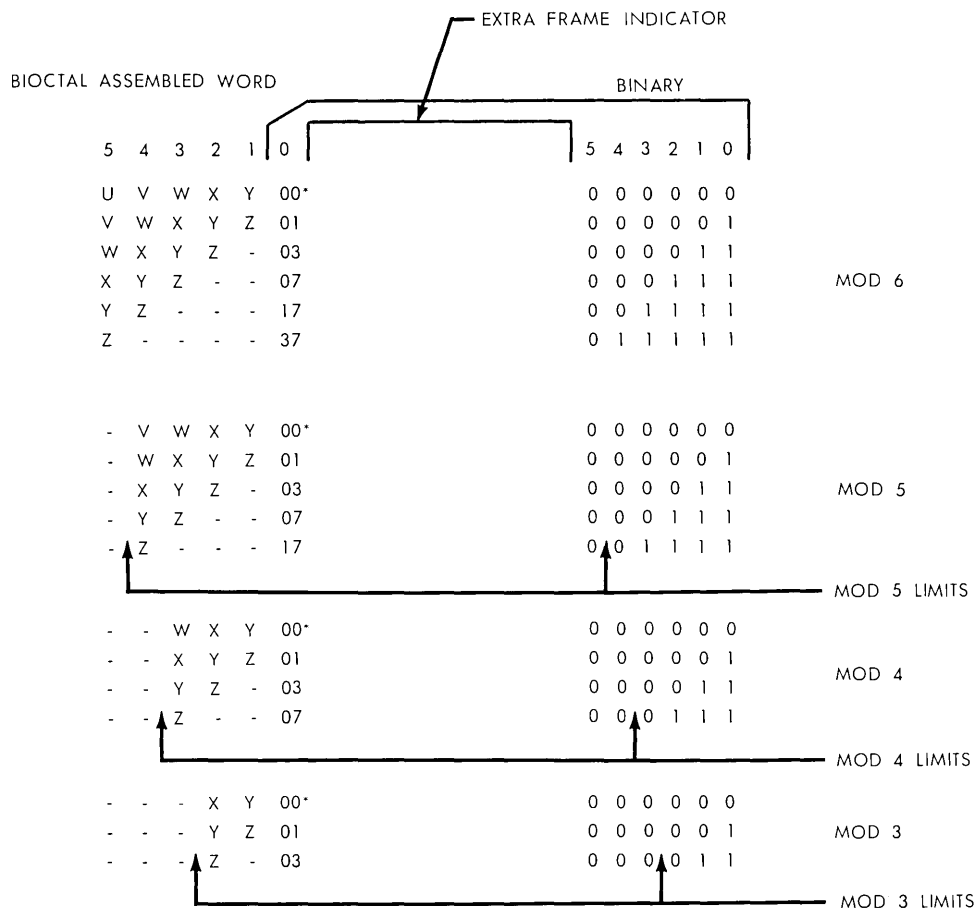

NOTE: Z denotes last frame, Y denotes second last frame, etc. A "0" in the extra frames indicator denotes a valid frame of data in the corresponding portion of the computer word within the modulus limits.

Figure 15. Transmit-Extra Computer Word Format

Acknowledge line; the Magnetic Tape Unit Input Request line is connected to the High-Speed Printer Output Acknowledge line; the Magnetic Tape Unit Interrupt line is connected to the High-Speed Printer External Function line; the Magnetic Tape Unit data lines are connected to the High-Speed Printer data lines.

The High-Speed Printer exercises control of the OFF-LINE system after the Magnetic Tape Unit is switched to Printer Mode, the desired tape transport is selected, and the tape is positioned at Load Point. The High-Speed Printer will initiate the operation when it is placed in OFF-LINE position.

*The word is identical with the last (normally transmitted) word except that Z₀ has been destroyed, no extra frames are present, and the transmit extra command should not have been used.

TABLE 4. TYPE SYMBOLS AND CODES

Octal Code	Binary Code	Character	Octal Code	Binary Code	Character
00	000 000	Absolute Value	40	100 000)
01	000 001	↑ Arrow (Up)	41	100 001	-
02	000 010	8 Subscript Eight	42	100 010	+
03	000 011	[Bracket (Open)	43	100 011	<
04	000 100] Bracket (Close)	44	100 100	=
05	000 101	Space (Undercut)	45	100 101	>
06	000 110	A	46	100 110	≤ Equal to or Less Than
07	000 111	B	47	100 111	{ Left-Hand Brace
10	001 000	C	50	101 000	★ Star
11	001 001	D	51	101 001	(
12	001 010	E	52	101 010	≥ Equal to or Greater Than
13	001 011	F	53	101 011	'
14	001 100	G	54	101 100	} Right-Hand Brace
15	001 101	H	55	101 101	∨ (Or)
16	001 110	I	56	101 110	∴
17	001 111	J	57	101 111	≠
20	010 000	K	60	110 000	0
21	010 001	L	61	110 001	1
22	010 010	M	62	110 010	2
23	010 011	N	63	110 011	3
24	010 100	O	64	110 100	4
25	010 101	P	65	110 101	5
26	010 110	Q	66	110 110	6
27	010 111	R	67	110 111	7
30	011 000	S	70	111 000	8
31	011 001	T	71	111 001	9
32	011 010	U	72	111 010	∧ And
33	011 011	V	73	111 011	;
34	011 100	W	74	111 100	/
35	011 101	X	75	111 101	.
36	011 110	Y	76	111 110	→ Arrow Right
37	011 111	Z	77	111 111	x Multiply Sign

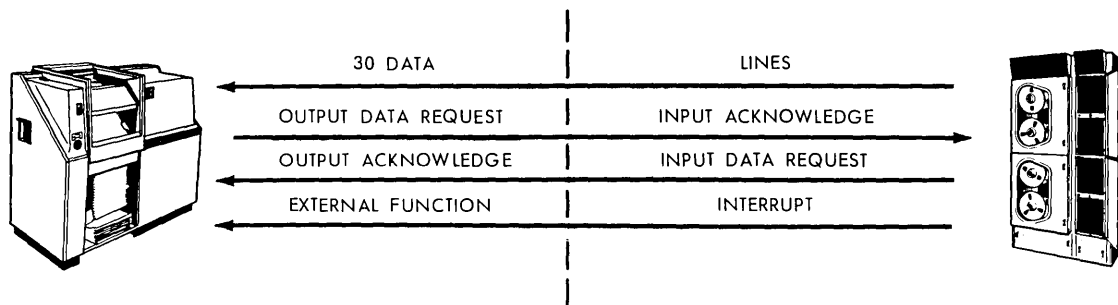

Figure 16. Magnetic Tape - Printer Interface

The data on magnetic tape to be printed OFF-LINE must be recorded in 120 Fielddata character record lengths (120 characters per line on High-Speed Printer). As each record is read from the tape and transmitted to the High-Speed Printer, the 120 characters are printed as one line and the paper is advanced to the next line position. Each 30-bit word delivered to the High-Speed Printer must contain five Fielddata Code characters (refer to Table 4). These are in turn disassembled into six-bit characters and stored in the character core memory of the High-Speed Printer Control Unit. One word can be stored each 54 microseconds. (Refer to Table 1 for recording density limitations.) When the core memory character counter indicates 120 characters, the print cycle is initiated and the line is printed. A record of less than 24 thirty-bit words will indicate to the High-Speed Printer to stop the print operation. A record of five space codes (05) will stop the print operation without printing a line.

Operating Instructions

To prepare the OFF-LINE Magnetic Tape Unit-High-Speed Printer system for operation the operator must select:

- Character, parity, and density of the recorded tape at the Magnetic Tape Unit cabinet;
- Switch the Magnetic Tape Unit to Printer Mode;
- Select the desired tape transport;
- Load and position the tape at Load Point;
- Place the High-Speed Printer in OFF-LINE position.

Sequence of Events

The normal sequence of events for transfer of data to the High-Speed Printer is as follows:

- High-Speed Printer sets its Output Data Request;
- Magnetic Tape Subsystem, in the READY state, recognizes the first Output Data Request as a command to start the read operation;
- The Magnetic Tape Unit places a word on the data lines and sets its Input Data Request;
- High-Speed Printer recognizes this Input Data Request as an Output Acknowledge;
- High-Speed Printer samples the data lines and clears its Output Data Request;
- Magnetic Tape Unit recognizes the clearing of the Output Data Request as an Input Acknowledge.

The latter four steps are repeated until the complete record is transferred, at which time the line is printed, the paper is advanced, and the cycle is reinitiated. The process continues until the End of File Tape Mark is read. The High-Speed Printer recognizes the Tape Mark as a command to position the paper at Top of Form on the next page. The Interrupt line of the Magnetic Tape Unit being connected to the External Function line of the High-Speed Printer permits the End of Record and the Tape Mark Codes to be sent to the High-Speed Printer as commands to move paper one line space or Top of Form respectively.

UNIVAC

DIVISION OF SPERRY RAND CORPORATION
DEFENSE MARKETING
UNIVAC PARK, ST. PAUL, MINN. 55116
AREA CODE 612, 698-2451

UNIVAC Regional Offices—WASHINGTON, D. C., 20007, 2121 Wisconsin Avenue, 338-8510 • WALTHAM, MASS., 02154, 69 Hickory Drive, 899-4110 • COCOA BEACH, FLORIDA, 32931, Suite 176, Holiday Office Center, 1325 No. Atlantic Avenue, 783-8461 • HOUSTON, TEXAS, 77058, Suite 122, Alpha Building, 16811 El Camino Real, HU 8-2240 • DAYTON, OHIO, 45431, 5160 Springfield Street, 253-8157 • LOS ANGELES, CALIFORNIA, 90045, Suite 232, 6151 W. Century Blvd., 776-6171 • SAN BERNARDINO, CALIFORNIA, 92410, Suite 219, 808 East Mill Street, 889-1096 • SAN DIEGO, CALIFORNIA, 92110, 3045 Rosecrans, 224-3333

PX3662