

OCT 22 1990

**3.5" HIGH CAPACITY
FLOPPY DISK DRIVE
(FD1335H)
PRODUCT DESCRIPTION
806-521212-0**

PRELIMINARY

NEC Corporation
TOKYO, JAPAN

FD1335H

3.5" HIGH CAPACITY FLOPPY DISK DRIVE

PRODUCT DESCRIPTION

806-521212-0

PRELIMINARY

NEC Corporation

REV.	COMP.	Revision Record
1	0	April 1990 First edition

PRELIMINARY

CONTENTS

	Page
INTRODUCTION	
1. GENERAL	00
Notes on The Use of This FDD	00
Major Differences Between FD1137H and FD1335H	00
2. GENERAL SPECIFICATIONS	00
2.1 Device Specifications	00
2.2 Device Structure	00
2.3 Drive Operation	00
2.4 Media Specifications	00
2.5 Medium Structure	00
3. INTERFACE	00
3.1 Outline	00
3.2 Physical Specifications	00
3.2.1 Signal Types and Pin Assignment	00
3.2.2 Power Types, Pin Assignment, and Termination Condition ...	00
3.2.3 Connector Models	00
3.3 Electrical Specifications	00
3.3.1 Signal Level	00
3.3.2 Driver/Receiver Circuits	00
3.4 Input Signal Description	00
3.4.1 Drive Select 0-1 (DS0 to 1)	00
3.4.2 Density Control 1, 2 (DEN 1, 2)	00
3.4.3 Motor on (MON)	00
3.4.4 Side Select (SL)	00
3.4.5 Write Gate (WGT)	00
3.4.6 Write Data (WDT)	00
3.4.7 Step (STEP)	00
3.4.8 Direction Select (DIR)	00
3.5 Output Signal Description	00
3.5.1 Index (IDX)	00
3.5.2 Track 0 (TRK0)	00
3.5.3 Ready (RDY) (Internal Signal)	00
3.5.4 Disk Change (DCG)	00
3.5.5 Write Protect (WPRT)	00
3.5.6 Read Data (RDT)	00
3.6 Interface Signal Timing	00

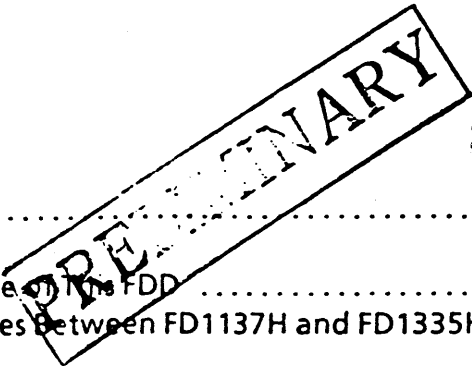

PRELIMINARY

3.6.1	Access Invalid Time	00
3.6.2	Seek Timing	00
3.6.3	Track 0 Timing	00
3.6.4	Recalibrate Timing	00
3.6.5	Side Select Timing	00
3.6.6	Read/Write Timing	00
3.7	Power Interface	00
3.7.1	Input Power Specifications	00
4.	OPERATING PROCEDURE	00
4.1	Mounting a Medium	00
4.2	Removing a Medium	00
4.3	Display Lamp	00
5.	APPEARANCE AND INSTALLATION	00
5.1	Appearance and Mounting Hole Positions	00
5.2	Installation	00
6.	PACKING AND TRANSPORTATION	00

INTRODUCTION

NEC has developed a practical 3.5" high capacity floppy disk drive (FDD) capable of reading and writing 13.3 MB high capacity media as well as conventional 1 MB and 2 MB media. This high capacity FDD offers formatted capacity of 10.2M bytes, about ten times the conventional capacity. The new FDD supports wider personal file applications such as an image file, system disk distribution, and hard disk backup file besides the applications provided by the conventional FDD.

PRELIMINARY

1. GENERAL

The FD1335H 3.5" floppy disk drive supports the metal media of 13.3M bytes (unformatted; 10.2B bytes formatted) at 431TPI (tracks per inch) as well as the conventional 2DD and 2HD media.

In the lower-end compatibility mode (1M/2M mode), the FD1335H can read and write the conventional 3.5" 135-TPI single-/double-sided floppy disks.

In the 13 MB mode, a closed loop servosystem technology is used in head positioning. This servosystem is called a sector servosystem where servo information is obtained from each sector, which ensures high positioning accuracy and reliability against media temperature and humidity change.

The FD1335H uses a linear pulse motor which has been developed exclusively by NEC and has had a proven record with the conventional models (FD1X37 series). A full attention has been paid to noise reduction.

The FD1335H 3.5" floppy disk drive is denoted as FDD in this manual.

Notes on The Use of This FDD

(1) Media in the 13 MB mode

Use NEC-specified dedicated media. The media case has a mark "TD" printed.

Be sure to use these media when making read/write access to 13.3M-byte floppy disks (FD).

The media come with prerecorded servo information giving them high track density, which fixes the per-sector capacity to 512 bytes.

Accordingly, physical formatting in the 13 MB mode is prohibited.

(2) Interfacing the host system

This FDD provides the conventional 3.5" FDD standard interface plus another density control signal.

The FDD uses this signal to read/write 13.3 MB media, besides the conventional interface for reading/writing 2HD/2DD media.

The details will be given later.

(3) Building a system

A controller μ PD72069 is recommended for building a system. For details, refer to the Application Manual.

Major Differences Between FD1137H and FD1335H

No.	Item	FD1335H	FD1335H (lower-end R/W function)	Unit
1	Device environment (operating)			
1-1	Shock allowance	5 (3)	3	G
2	I/F circuit			
2-1	Output driver sink capacity	40	12	mA
2-2	Signal level	TTL level	TTL and CMOS common level	
2-3	Density control	Can output FDD to FDC.	Cannot output FDD to FDC.	
3	Source voltage	+5 V <u>+5%</u>	+5 V <u>+5%</u> +12 V <u>+10%</u>	
4	DC power requirement	Omitted	Omitted	
5	Appearance	Omitted	Omitted	
6	Head load option	Provided	Not provided	
7	Access inhibit time	None	100 ms after power-on	
8	LED lamp color	Red	Green	

2. GENERAL SPECIFICATIONS

2.1 Device Specifications

[13 MB mode]

No.	Item		Specification	Unit
1	Capacity (MFM)	Unformatted	13.3	MB
		Formatted (2 sides x 255 CYL)	* 10.18 (512B, 39 sec fixed)	MB
2	Data transfer rate (MFM)		1.25	M-bit/S
3	Average rotational speed		360	rpm
4	Number of tracks		510 (255 CYL x 2 Side)	
5	Track density		431	TP1
6	Maximum bit density		36595	BP1
7	Recording mode		MFM	
8	Seek time (on one track)		3	mS
9	Settling time		100 (TYP)	mS
10	Recommended write preshift		50 (200 CYL and over)	nS
			0 (less than 200 CYL)	nS

* Bad sectors (up to 10) are included.

[2.0 MB mode]

No.	Item		Specification	Unit
1	Capacity (MFM)	Unformatted	2.0	MB
		Formatted	1.47 (512, 15 Sec)	MB
2	Data transfer rate (MFM)		500	k-bit/S
3	Average rotational speed		300	rpm
4	Number of tracks		160 (80 Trac x 2 Side)	
5	Track density		135	TPI
6	Maximum bit density		17432	BPI
7	Recording mode		MFM/FM	
8	Seek time (on one track) *1		3	mS
9	Settling time		15	mS
10	Recommended write preshift		0	nS

[1.0 MB mode]

No.	Item		Specification	Unit
1	Capacity (MFM)	Unformatted	1.0	MB
		Formatted	737 (512, 9 Sec)	MB
2	Data transfer rate (MFM)		250	k-bit/S
3	Average rotational speed		300	rpm
4	Number of tracks		160 (80 Trac x 2 Side)	
5	Track density		135	TPI
6	Maximum bit density		8717	BPI
7	Recording mode		MFM/FM	
8	Seek time (on one track) (*1)		3	mS
9	Settling time		15	mS
10	Recommended write preshift		0	nS

*1 See Section 3.6.2.

[Common specifications]

No.	Item		Specification			Unit
10	Start time (*1)		500			mS
11	Standard overall dimensions (*2)	Thickness	25.4			mm
		Width	101.6 (104 Max)			
		Depth	130			
12	Weight					g
13	Power supply	Voltage (V)	Motor OFF	Startup current	Steady-state current (*3)	mA
		+12		520	300	
		+5		300	260	
14	Power dissipation (*3)		6			W
15	Heat output (*3)		5.2			Kcal/S
16	Reliability	MTBF	12000			POH
		MTR	0.5			H
		Device life (*4)	15000 POH or 5 years (design life)			
		Retriable error rate	10 ⁻⁹ (not counting first and second retries)			Times/bit
		Unretrieable error rate	10 ⁻¹²			Times/bit
		Seek error rate	10 ⁻⁶			Times/bit
17	Floppy disk life	Number of passes/track	3.0 x 10 ⁶			
18	Media	13 MB mode	3.5" double sided metal floppy disk (2TD) with servo information			
		2.0 MB mode	3.5" double sided high density floppy disk (2HD)			
		1.0 MB mode	3.5" double sided double density floppy disk (2DD)			

No.	Item		Specification		Unit
19	Environ- mental condi- tion	Device environment	Operating	Transporting (packing)	
		Temperature	4 ~ 46 (*5)	-40 ~ 65	°C
		Relative humidity	20 ~ 80	5 ~ 95	%RH
		Maximum wet bulb temperature	29 (no condensation)	45	
		Maximum temperature gradient	20	30	°C/H
		Vibration allowance (except at resonance point)	0.5 (10 ~ 100 Hz)	2 (10 ~ 100 Hz)	G
		Shock allowance (not more than 10 ms)	3	40	G

- *1 The time for the unit to get READY after MOTOR ON.
- *2 The figures in parentheses include the front panel size.
- *3 Values during READ operation of FDD. A terminating resistor of 1 kΩ for controller interface is assumed.
- *4 Standard operating conditions
 - (1) Device service (POH): 8 H/day
 - (2) Motor operating hours (R/W time): 2 H/day
 - (3) Number of media insertions/ejections: 25 times/day
 - (4) Number of motor ONs/OFFs: 300 times/day
- *5 The environment assumes absence of forced air cooling.

2.2 Device Structure

The functions of major components of FDD are:

- (1) Motor module
Incorporates two magnetic heads, a linear pulse motor, and spindle motor.
- (2) Case and cover
Protects the device, providing dust-proofing and shielding effect.
- (3) Index sensor
Senses one index for each rotation of the spindle motor.
- (4) Track 0 sensor
Senses that the magnetic head is on track 0.
- (5) Write protect sensor
Senses the open/close state of the write protect hole on a medium.
- (6) Eject mechanism
Inserts/ejects a medium and opens/closes the shutter automatically.
- (7) PWB assembly
Mounts an electronic circuit that controls magnetic head positioning, read/write operation, etc.
- (8) Display lamp
An LED indicating the FDD status.
- (9) Front panel
A dress panel fitted to the device front.

2.3 Drive Operation

After supplying dc power to the FDD, insert a medium into the drive. Then the medium starts rotation and is chucked. The FDD becomes ready when the medium rotational speed reaches a defined value after the motor has turned ON, enabling a read/write operation.

The controller sends density control 1, 2 signals to the FDD to set up a capacity mode (1 MB, 2 MB, 13 MB).

When the capacity mode changes from 13 MB mode to 1 or 2 MB mode, or vice versa, the controller lets the FDD perform calibration and return the magnetic head to track 0.

After this, on receiving a step pulse from the controller, the FDD moves the magnetic head in the direction specified by a direction signal in 135 TPI (track-per-inch) steps in the case of 1 or 2 MB mode.

In the 13 MB mode, the FDD similarly moves the magnetic head in 431 TPI steps and, on completion of this motion, positions the magnetic heads accurately to a desired track based on the medium-recorded servo information.

Then the controller performs a read/write operation after selecting a desired magnetic head by a side select signal.

In the write operation, the FDD converts a bit-serial WRITE DATA signal sent from the controller into a magnetic pattern and records it on the medium. In the read operation, the FDD senses a magnetic pattern recorded on the medium, converts it to serial data, and sends the data to the controller as a READ DATA signal.

Since this FDD does not mount a VFO, it sends raw read data.

This drive can read and write a servo-attached 3.5" double sided metal floppy disk, 3.5" double sided high density floppy disk, and 3.5" double sided double density floppy disk. The mode must be switched with density control signals 1, 3 to match the medium used. The switching is instructed by the FDD controller to the FDD.

2.4 Media Specifications

[13 MB mode]

No.	Item		Specification
1	Media type		Servo-attached 3.5" double sided metal floppy disk (NEC-specified media)
2	Product name (NEC mnemonic)		Microfloppy 2TD (EMC2TD)
3	Number of disks		1
4	Number of recording surfaces		2
5	Number of tracks/medium	Total number	510
6	Disk cartridge size		90 x 94 mm
7	Operating environment condition (*1)	Temperature	10 ~ 51.5°C
		Humidity	20 ~ 80% RH
		Wet bulb temperature	Not more than 29°C
		Temperature gradient	Not more than 20°C/H
		External magnetic field	Not more than 4000 A/m (50 oersted)
		Standing time	Leave the drive acclimatized to the operating environment for at least 30 minutes before use.

*1 Measure the temperature and humidity in the air near the media. For an external magnetic field, use the value on the medium surface which would include the effect of concentration of magnetic flux due to the head.

[2.0 MB mode]

No.	Item		Specification
1	Media type		3.5" double. sided high density floppy disk (NEC-specified media or equivalent)
2	Product name		Microfloppy 2HD (MC2HD)
3	Number of disks		1
4	Number of recording surfaces		2
5	Number of tracks/medium	Total number	160
6	Disk cartridge size		90 x 94 mm
7	Operating environment condition (*1)	Temperature	10 ~ 51.5°C
		Humidity	20 ~ 80% RH
		Wet bulb temperature	Not more than 29°C
		Temperature gradient	Not more than 20°C/H
		External magnetic field	Not more than 4000 A/m (50 oersted)
		Standing time	Leave the drive acclimatized to the operating environment for at least 30 minutes before use.

*1 Measure the temperature and humidity in the air near the media. For external magnetic field, use the value on the medium surface which would include the effect of concentration of magnetic flux due to the head.

[1.0 MB mode]

No.	Item		Specification
1	Media type		3.5" double sided double density floppy disk (NEC-specified media)
2	Product name		(NEC mnemonic) Microfloppy 2DD (MC2DD)
3	Number of disks		1
4	Number of recording surfaces		2
5	Number of tracks/medium	Total number	160
6	Disk cartridge size		90 x 94 mm
7	Operating environment condition (*1)	Temperature	10 ~ 31.5°C
		Humidity	20 ~ 80% RH
		Wet bulb temperature	Not more than 29°C
		Temperature gradient	Not more than 20°C/H
		External magnetic field	Not more than 4000 A/m (50 oersted)
		Standing time	Leave the drive acclimatized to the operating environment for at least 30 minutes before use.

*1 Measure the temperature and humidity in the air near the media. For external magnetic field, use the value on the medium surface which would include the effect of concentration of magnetic flux due to the head.

2.5 Medium Structure

A medium comes with a disk sealed in a hard case. There is a protective sheet liner on the inside of the hard case. The disk consists of a polyethylene terephthalate and other base to which is coated magnetic material. The liner is made of material like unwoven cloth which can remove dust without scratching the medium. The hard case is made of ABS resin.

The disk is provided with a metal hub for chucking the medium to the spindle. The hard case has a write protect hole and an automatic shutter.

The medium structure depends on its type. This is illustrated in Figures 2.1, 2.2, and 2.3.

The write protect hole has a sliding tab which can be opened or closed with a finger tip.

The write protect hole, when open, inhibits write to the medium, protecting the data from destruction through overwriting.

Figure 2.1 1 MB Medium (2DD)

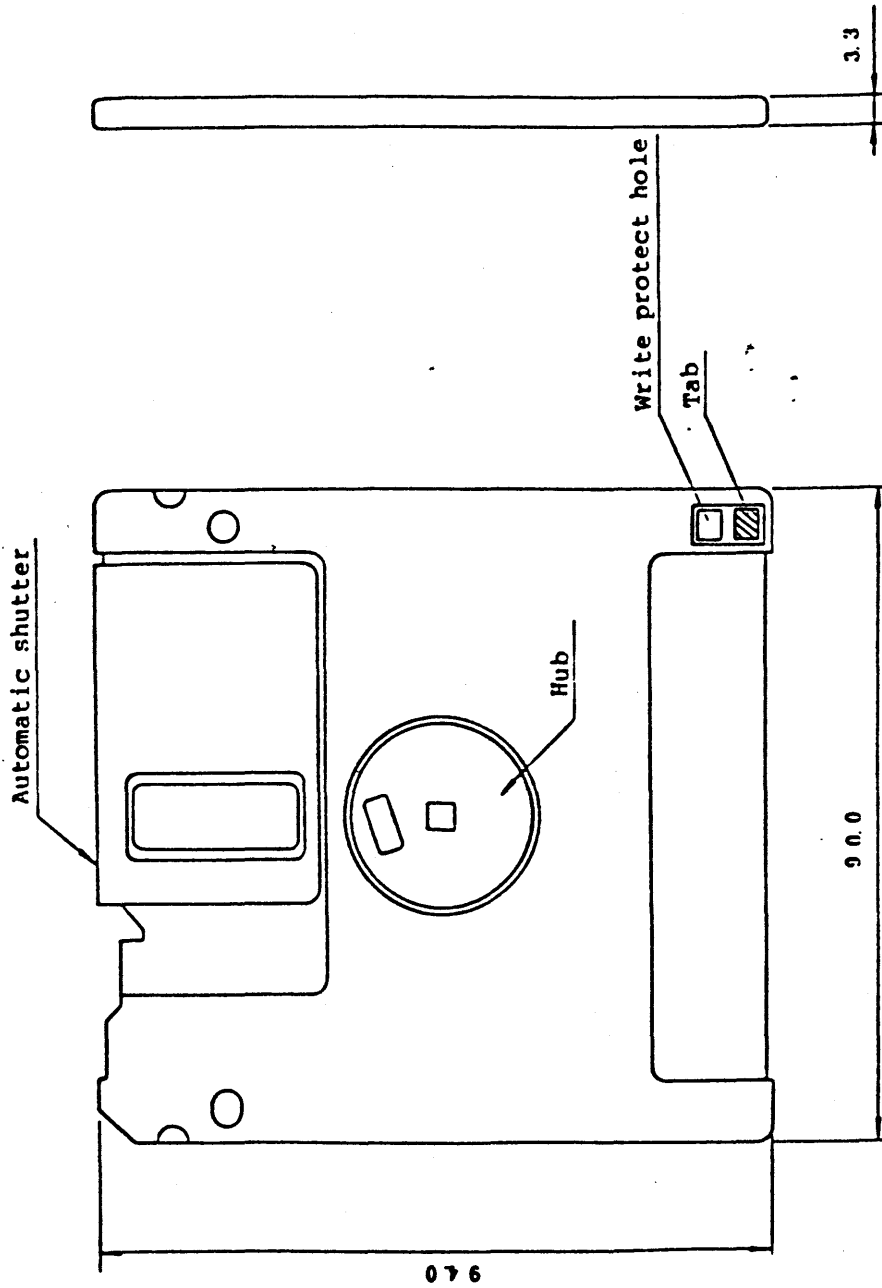
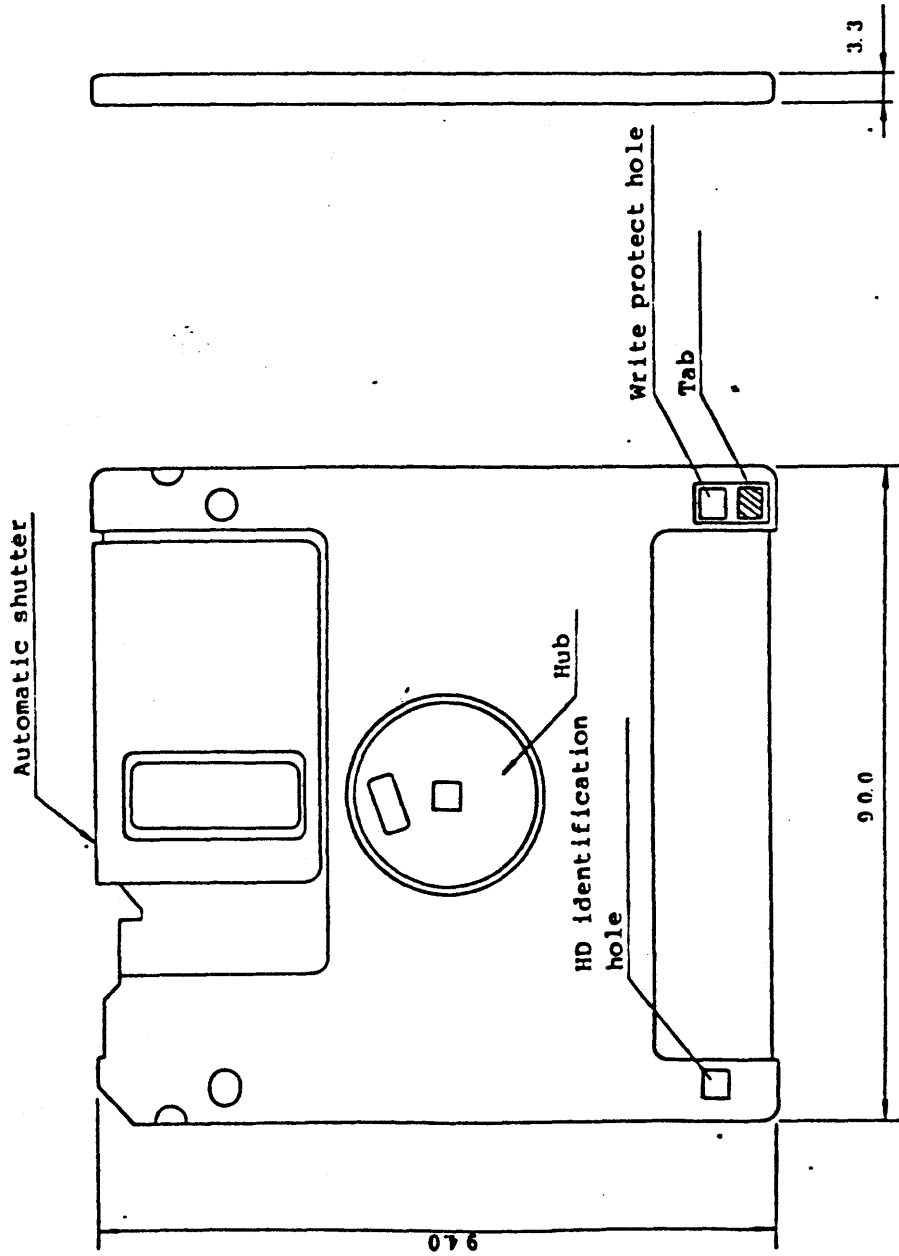

Figure 2.2 2 MB Medium



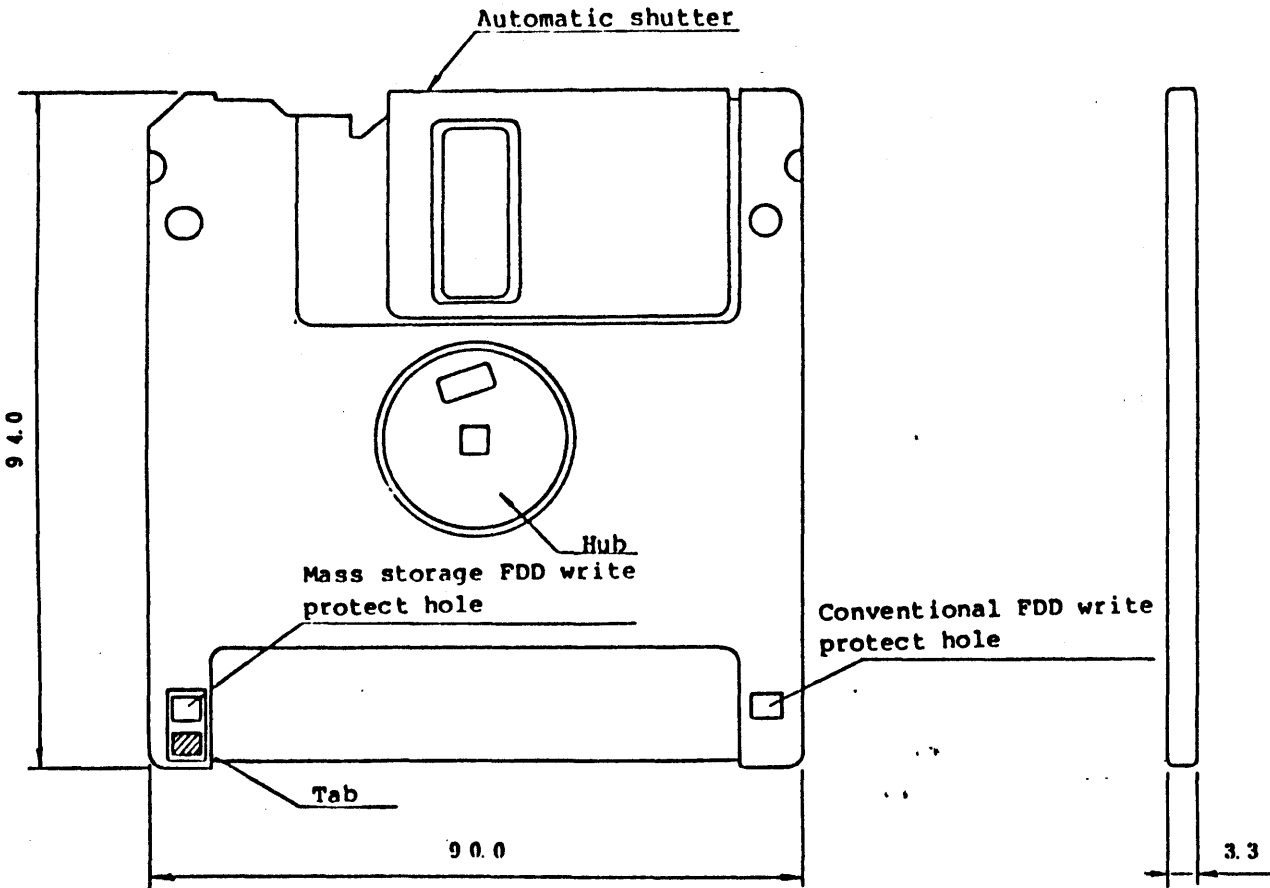

Figure 2.3 13 MB Medium

3. INTERFACE

3.1 Outline

FDD can be connected to the disk controller in a parallel or daisy chain connection mode. The number of FDDs that can be connected to a controller depends on the processing system and the controller function. Up to two FDD can be connected in a daisy chain configuration.

In the daisy chain connection, power must be supplied to all FDD connected for normal FDD operation.

A terminating resistor for cable termination is installed for each FDD.

Figure 3.1 shows the basic connection of FDD and the controller.

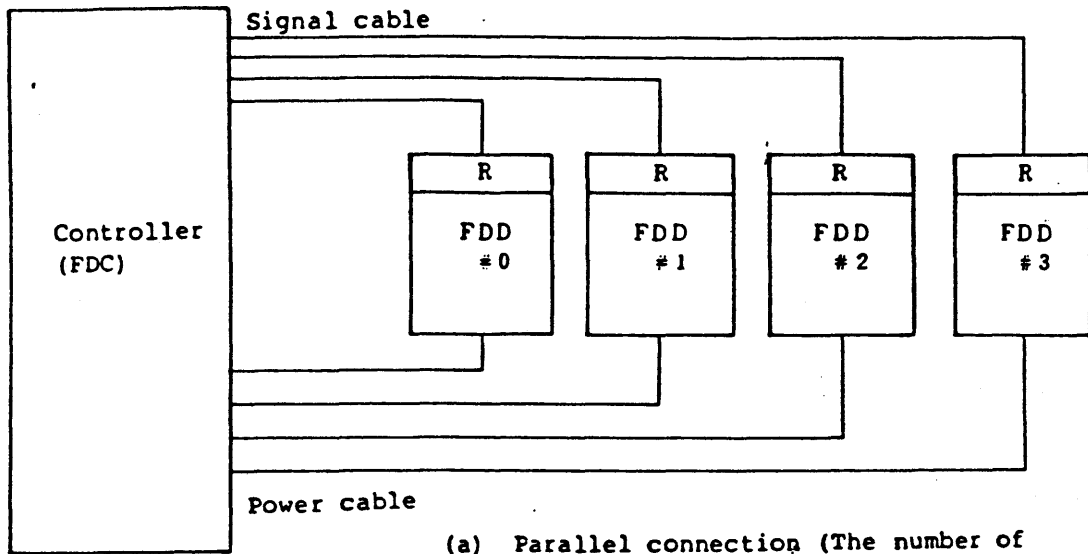

(a) Parallel connection (The number of connectable FDD depends on the system and the controller.)
 R: terminating resistor

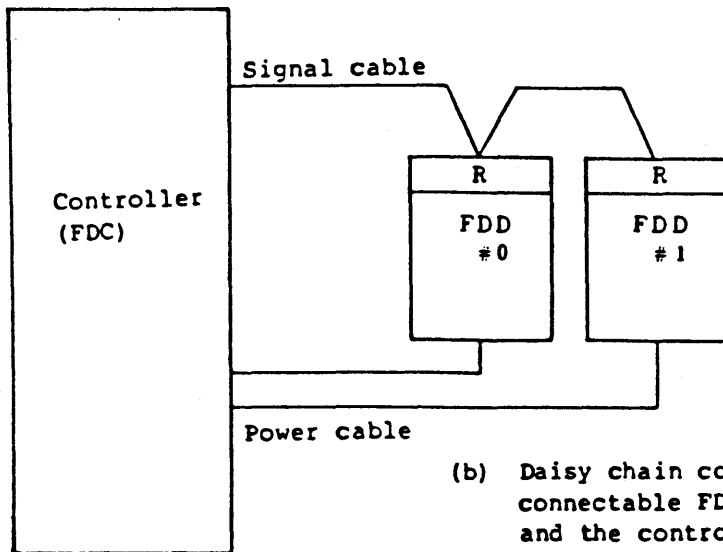

(b) Daisy chain connection (The number of connectable FDD depends on the system and the controller, but does not exceed 2.)
 R: terminating resistor

Figure 3.1 Basic Connection Mode

3.2 Physical Specifications

The FDD and the controller are connected via a "signal connector" transferring control and data signals and a "power connector" supplying dc power.

Figure 3.2 outlines the connector locations.

Figure 3.5 shows recommended models.

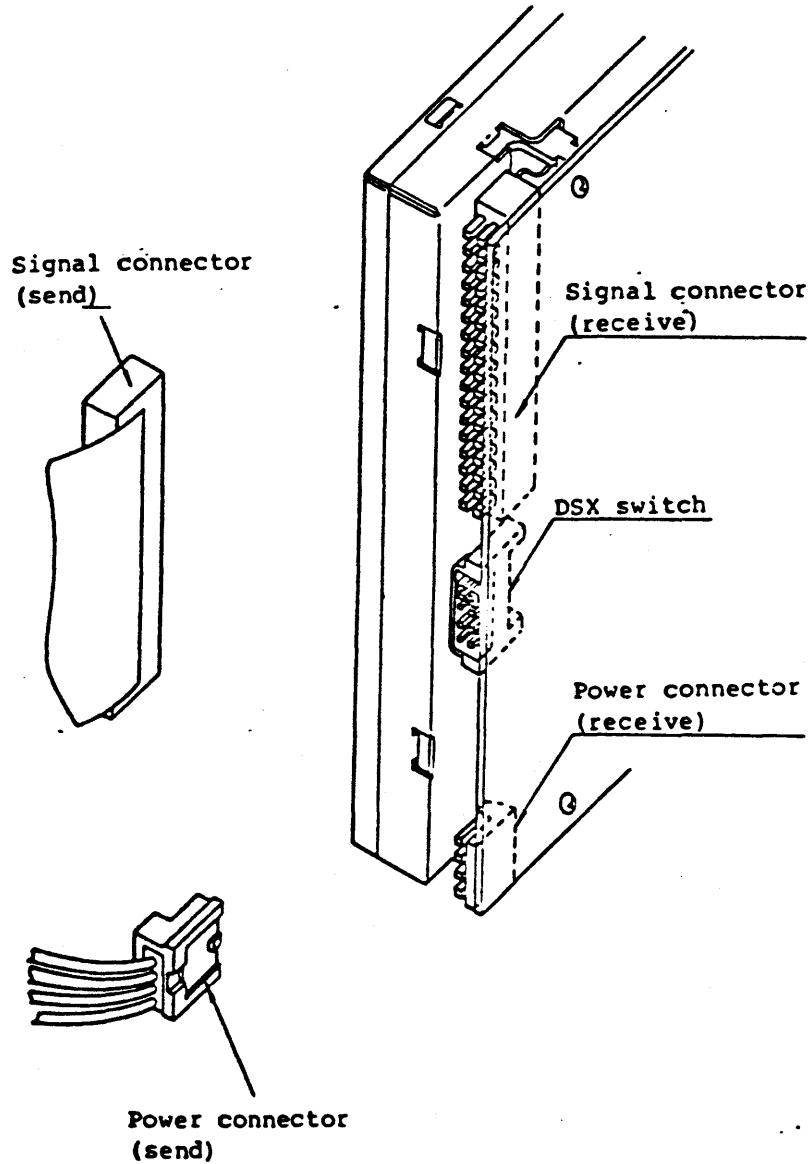

Figure 3.2

3.2.1 Signal Types and Pin Assignment

The following shows the FD1335 signal connector physical pin numbers and signal pin assignment.

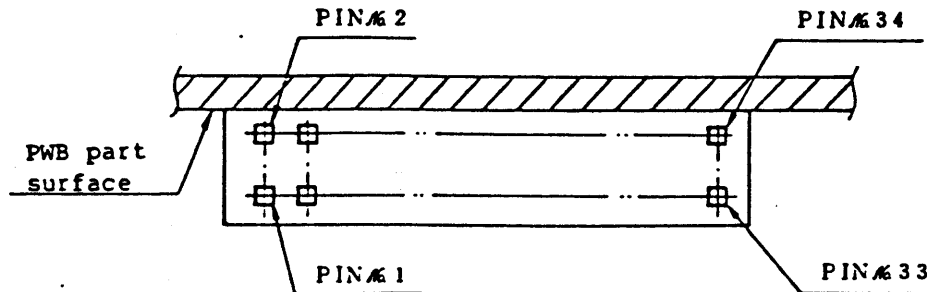

Figure 3.3 Pin Assignment

Table 3.1 Signal Connector Pin Assignment

Signal name	I/O	PIN No.	PIN No.	I/O	Signal name
DENSITY CONTROL 2	I	2	1		GND
IN USE	I	4	3	OPEN	RESERVED
RESERVED *3	OPEN	6	5		GND
INDEX	O	8	7	OPEN	RESERVED
DRIVE SELECT 0	I	10	9		GND
DRIVE SELECT 1	I	12	11	OPEN	RESERVED
RESERVED	OPEN	14	13		GND
MOTOR ON	I	16	15	I	DENSITY CONTROL *1
DIRECTION SELECT	I	18	17		GND
STEP	I	20	19		GND
WRITE DATA	I	22	21		GND
WRITE GATE	I	24	23		GND
TRACK 000	O	26	25		GND
WRITE PROTECT	O	28	27	I	DENSITY CONTROL *1
READ DATA	O	30	29		GND
SIDE SELECT	I	32	31		GND
READY/DISK CHANCE *4	O	34	33		GND

I: Input signal (from controller to FDD)

OPEN: Unconnected to FDD

O: Output signal (from FDD to controller)

*1 Select either pin 15 or 27.
If not shared, assign pin 15 to drive 0.

*2 This may be connected to drive select 2.

*3 This may be connected to drive select 3.

*4 This can be switched by factory option.

3.2.2 Power Types, Pin Assignment, and Termination Condition

The following shows the power connector physical pin numbers and power pin assignment.

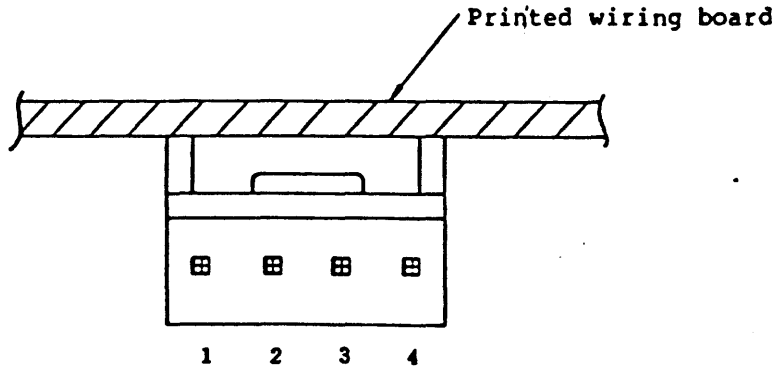

Figure 3.4 Power Connector Physical Pin Numbers

Table 3.2 Power Assignment

Pin number	Power
1	+5 VDC
2	GND
3	GND
4	+12 VDC

The following shows the terminating condition of this FDD at the time of factory shipment:

SG, FG are shorted.

3.2.3 Connector Models

The following shows recommended models. Equivalents may also be used.

Signal connector,
Sumitomo 3M (Corp.)
7934-6000
(daisy chain type)
3414-6000
(daisy chain type)
7934-6000
(closed end type)
3414-6000
(closed end type)

Cable,
Sumitomo 3M (Corp.)
3365-34 or
equivalent

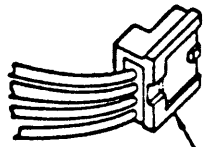
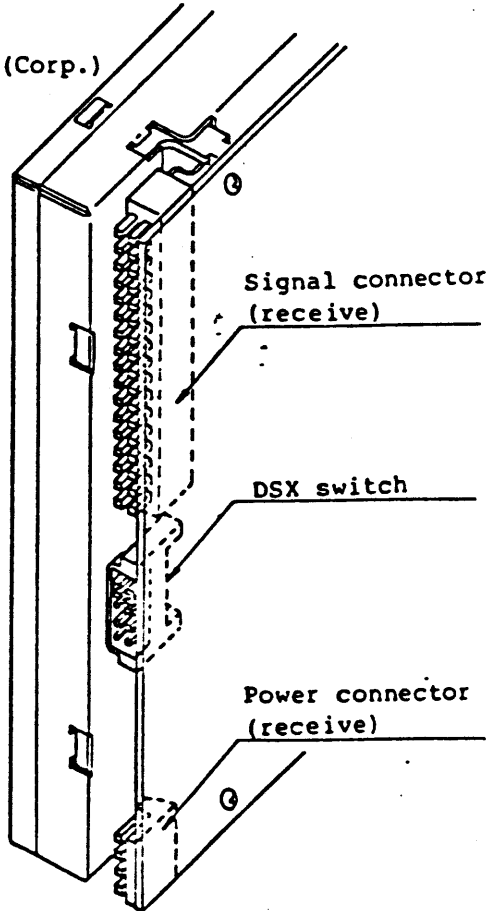
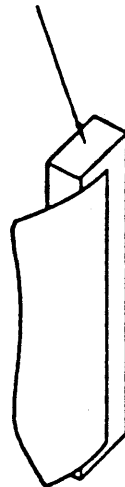

Power connector,
Nihon AMP connector
Housing 171822-4
Pin 170262-1 or
equivalent

Figure 3.5 Connector Locations and Recommended Models

3.3 Electrical Specifications

3.3.1 Signal Level

All input/output signals are at the TTL and CMOS common level and have the following electrical characteristics:

TRUE = logic "0" (LOW level): 0 ~ +0.4 V

FALSE = logic "1" (HIGH level): +4.0 ~ +5.25 V (*1)

*1 This must not exceed the operating source voltage.

The voltage level is a value at the FDD connector.

3.3.2 Driver/Receiver Circuits

The driver circuit sending a signal from the FDD to the controller is an open drain output circuit which produces a sink current of maximum 12 mA at the LOW level. The receiver getting a signal from the controller to the FDD is a Schmitt trigger gate terminating with 1 kΩ.

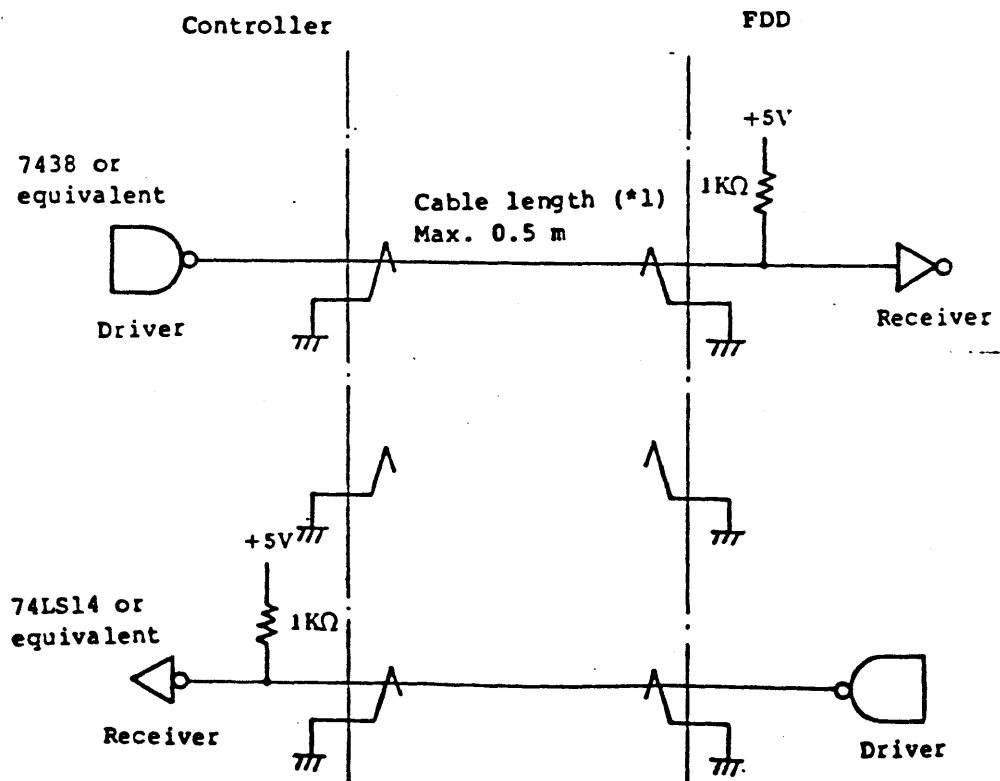

*1 Max. 1 m if more than one FDD is connected to a single controller in a daisy chain configuration.

Figure 3.6 Driver/Receiver Circuit Example

3.4 Input Signal Description

All timing values are defined at the FDD connector.

3.4.1 Drive Select 0~1 (DS0 to 1)

DRIVE SELECT 0~1

Setting either of these signals to logic 0 selects a drive.

The drive number is set with the DSX switch. The switch is factory-set to 0.

In the following explanation, the drive select signal may be abbreviated as DSX.

The in-use, direction select, step, write data, write gate, and side select signals become valid when the drive is selected.

The density control 1 and 2 and motor-on signals are valid even when the drive is not selected.

3.4.2 Density Control 1, 2 (DEN 1, 2)

DENSITY CONTROL 1, 2

Setting the density control 1 and 2 signal levels appropriately allows you to select the 13 MB, 2.0 MB, or 1.0 MB mode.

These signals are not gated by the drive select.

Mode	DEN1	DEN2	Storage capacity [MB]	Track density [TPI]	Data transfer rate [kb/s]	Rotational speed [RPM]
13 MB mode	H	X	13.3	431	1250	360
2.0 MB mode	L	L	2	135	500	300
1.0 MB mode	L	H	10	135	250	300

*1 If the track density is switched from 431 to 135 and 431 or from 135 to 431 and 135, repositioning to the original track before switching is not guaranteed.

(When DEN1 is switched, be sure to recalibrate.)

*2 If a medium is not mounted, the 135 TPI mode is automatically set regardless of the DEN1 status.

*3 In what follows, the difference in track density may be explained using the terms "431 TPI mode" and "135 TPI mode".

3.4.3 Motor on (MON)

MOTOR ON

With a medium mounted, setting the MON signal to the LOW level causes the spindle motor to operate.

Setting the signal to the HIGH level stops the spindle motor.

This signal is not gated with the drive select.

Turning the motor OFF/ON in the 135 TPI mode and with the disk inserted does not change the track position.

Inserting or removing the disk in the 135 TPI mode does not change the track position.

If the motor is turned OFF/ON in the 431 TPI mode and with the disk inserted, repositioning to the original track before the motor off is not guaranteed. (Calibrate to track 0.)

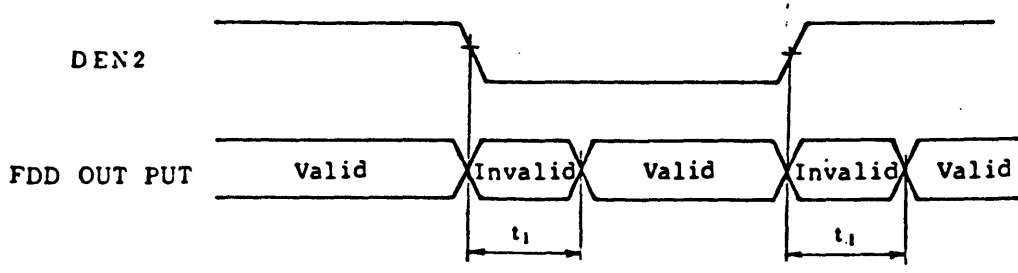

$t_1 \leq 20 \mu S$

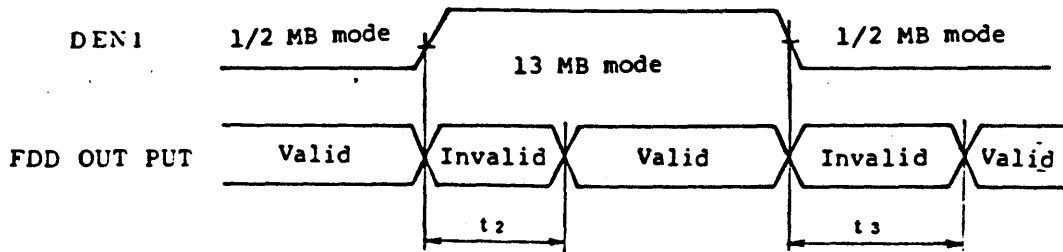

t_2 μ When a 2TD medium is inserted and the 13 MB mode is
 t_2 μ initially set.
 t_2 μ

3.4.4 Side Select (Sl)

SIDE SELECT

This signal selects the medium side used for read and write. When in the HIGH level, it selects the magnetic head on the side "0" of the medium. When in the LOW level, it selects the magnetic head on the side "1".

Switching this signal must take place 100 μ s before start of a read/write operation.

In the 431 TPI mode, when the side select signal is switched, about 50 ms is required for the servo mechanism to complete tracking of the data track. During this period, the FDD does not output read data or index. Accordingly, the FDC can execute an FDC read/write instruction without concern for the above period.

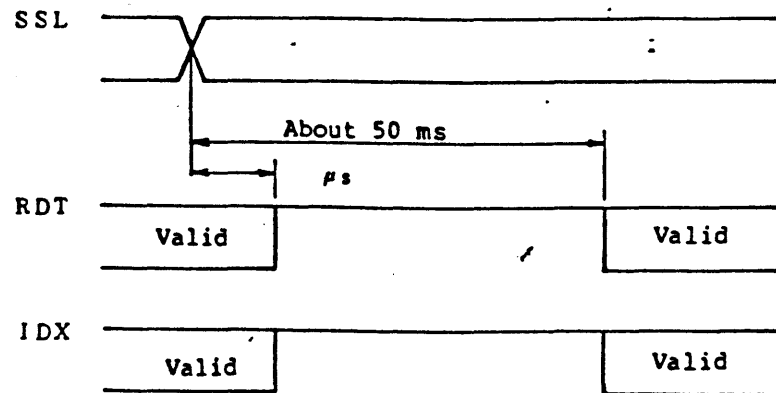

3.4.5 Write Gate (WGT)

WRITE GATE

This signal writes data when in the LOW level and reads data when in the HIGH level. Do not turn off the IN USE signal, switch the SIDE SELECT signal, start the positioning operation, or switch the density mode for the t_1 time shown below after this signal goes to the HIGH level.

$t_1 = 600 \mu$ s for the 2.0 MB mode

$t_1 = 1000 \mu$ s for the 1.0 MB mode

$t_1 = 0 \mu$ s for the 13 MB mode

The data write is enabled only when READY is true.

3.4.6 Write Data (WDT)

WRITE DATA

A pulse signal supplying write data to a medium. Every time this signal changes from the HIGH to LOW level, the current flowing in the magnetic head changes the direction, which changes the direction of magnetization on the medium. Figures 3.6 to 3.8 show the WRITE DATA specifications in the 13 MB, 2.0 MB, and 1 MB modes.

Not performing preshift in the 2.0 MB or 1 MB mode is recommended.

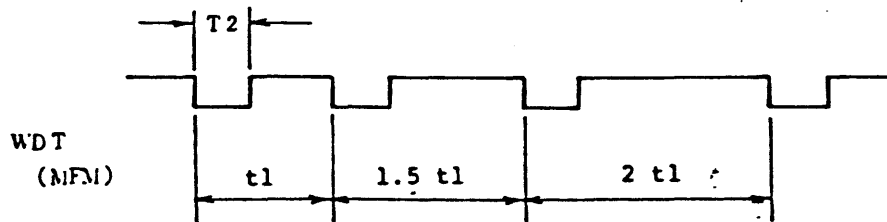

$t_1 : 800\text{nS}^*$

$t_2 : 100\sim 400\text{nS}$

*1 The error rate of the frequency of the clock that generates t_1 write data should not be more than $\pm 0.01\%$ (not including the preshift).

Figure 3.6 WRITE DATA Pulse Specifications (13 MB Mode)

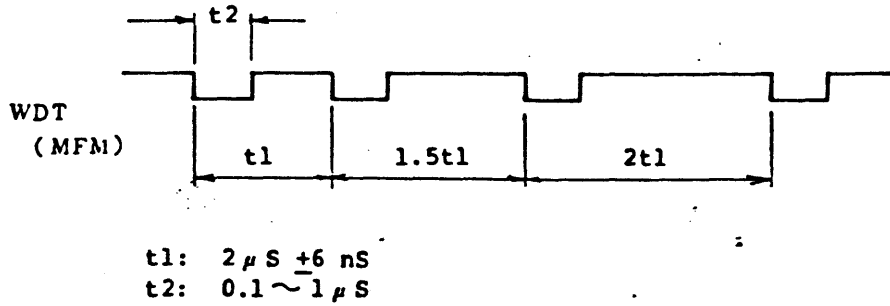
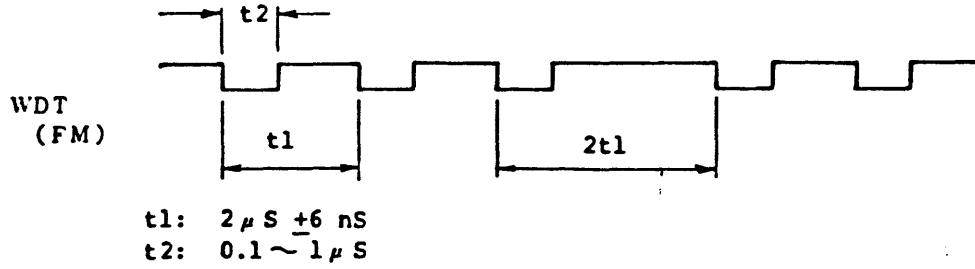

Figure 3.7 WRITE DATA Pulse Specifications (2.0 MB Mode)

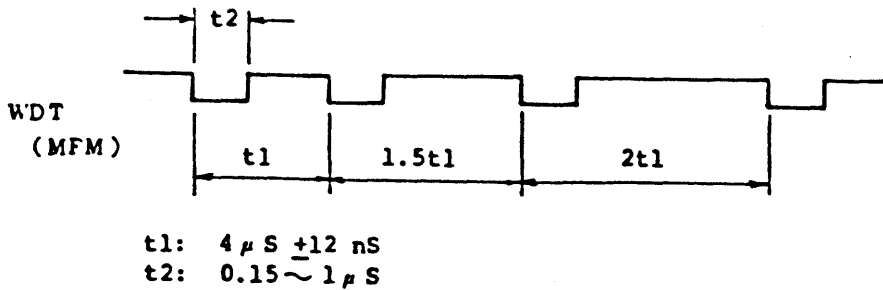
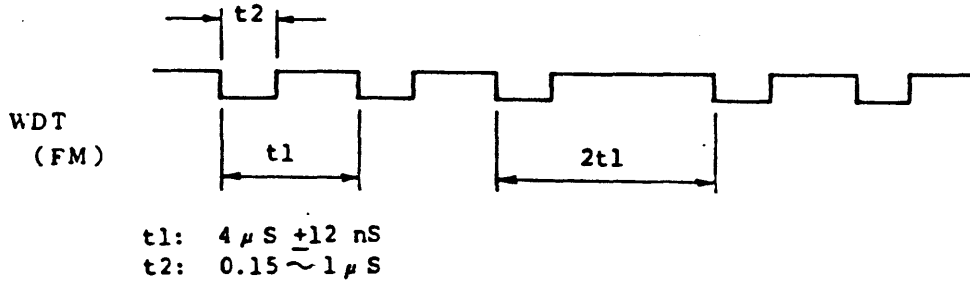
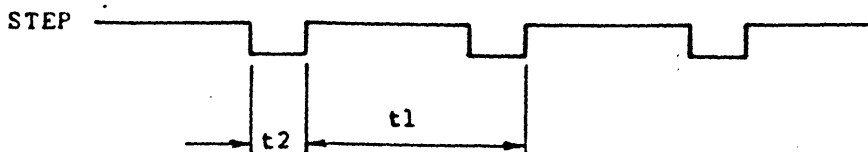

Figure 3.8 WRITE DATA Pulse Specifications (1 MB Mode)

3.4.7 Step (STEP)

STEP

A pulse signal that moves the magnetic head in a direction specified by the direction select signal. The magnetic head moves across the cylinder as much as the number of input pulses.



Mode	t1 (mS)	t2 (S)
13 MB	3 or more	0.8 or more
2.0 MB	3 or more	0.8 or more
1 MB	3 or more	0.8 or more

Figure 3.9 STEP Pulse Specifications

3.4.8 Direction Select (DIR)

DIRECTION SELECT

A signal specifying the direction of the head motion during seek.

Logic "1" specifies the outward direction and logic "0" the inward direction.

This signal must be switched and become valid 0.4 us before the leading edge of the STEP signal.

3.5 Output Signal Description

All output signals become valid 250 ns after the drive select.

All timing values are taken at the FDD connector.

3.5.1 Index (IDX)

INDEX

A negative logic pulse is output every time the medium makes a turn.

The falling edge of the pulse is set as a timing reference.

Pulse width = 3.3 ms (typ) (at 360 rpm)

Pulse period = 200 ms \pm 2 ms (at 300 rpm)

Pulse period = 166.67 ms \pm 1 ms (at 360 rpm)

Note 1: See Section 3.5.6.

3.5.2 Track 0 (TRK0)

TRACK 0

In the 135 TPI mode, this signal goes to logic "1" when the magnetic head is positioned to track 0.

In the 431 TPI mode, the signal goes to logic "0" when the track 0 sensor detects track 0 during recalibration. The signal goes to logic "1" after passage of some fixed time (see Section 3.6.3).

In other cases, the signal still retains the logic "1" level even when the magnetic head is positioned to track 0.

3.5.3 Ready (RDY) (Internal Signal)

READY

The READY signal goes to logic "1", enabling a write operation, when all of the following conditions are satisfied:

- (1) The +5 V and +12 V power is supplied.
- (2) The MOTOR ON signal is at logic "0".
- (3) A medium is set.
- (4) The rotational speed of the media has reached a defined value.
- (5) The drive has been selected.

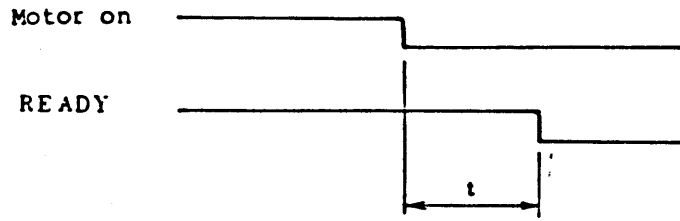

$$t = 500\text{ms}(\text{MAX}) (300\text{rpm}/360\text{rpm})$$

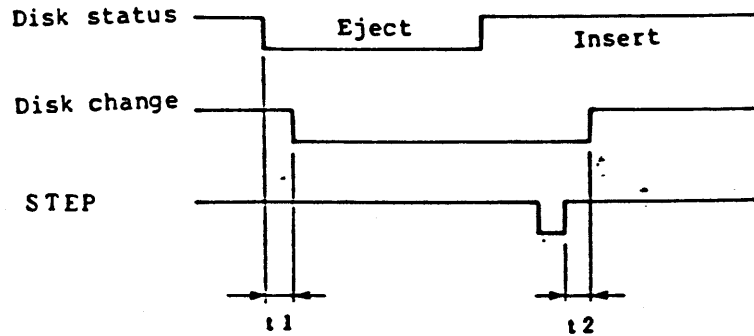

$$t1 < 1 \mu\text{s}, t2 < 1 \mu\text{s}$$

Note: When the MOTOR ON signal is set to the HIGH level, 500 ms (max.) is required for the drive to become ready again after resetting the signal to the LOW level.

3.5.4 Disk Change (DCG)

DISK CHANGE

The disk change signal goes to logic "0" when the medium is ejected and retains the logic "0" status after disk reinsertion.

With the medium mounted, the signal goes to logic "1" when a step signal is input during the drive select operation.

3.5.5 Write Protect (WPRT)

WRITE PROTECT

This signal goes to logic "1" when the medium is set in the write protect status, setting the FDD in the write inhibit status.

The following table shows the write protect status of various media.

Media type	Write protect hole (*2)	1 MB	2 MB	13 MB (*1)	(Write mode)
2DD/2HD	OPEN	L	L	L	(Signal level)
	CLOSE	H	H	H	
2TD	OPEN	L	L	L	
	CLOSE	L	L	H	

L: Write inhibited H: Write permitted

*1 In the 2TD media for 13 MB, physical formatting in 13 MB is prohibited since the media contain prerecorded servo information.

An attempt to write 2DD/2HD media in 13 MB leads to an error since ID cannot be read.

*2 The write protect hole on a 2DD/2HD medium is different from that on a 2TD medium. (See Figures 21, 22, 23.)

3.5.6 Read Data (RDT)

READ DATA

READ DATA (RDT) is a pulse string output of data read from the medium.

Notes:

1. In the 135 TPI and 431 TPI mode, no read data or index signal will be output till the positioning operation is completed following input of a step pulse.
2. In the 13 MB mode, no read data or index signal will be output till the drive is set in the ON TRACK status after the side change and seek.
3. No read data or index signal will be output for about one second till the drive becomes ready for read/write after inserting a 2TD medium and initially selecting the 13 MB mode. (See Section 3.4.2.)

3.6 Interface Signal Timing

All timing values are defined at the FDD connector.

(If not defined, timing measuring voltage 1.8 V is assumed (with source voltage of 5 V).)

3.6.1 Access Invalid Time

During the time t , no normal seek operation occurs if access is made to the FDD. A step pulse may be input.

- (1) Source voltage

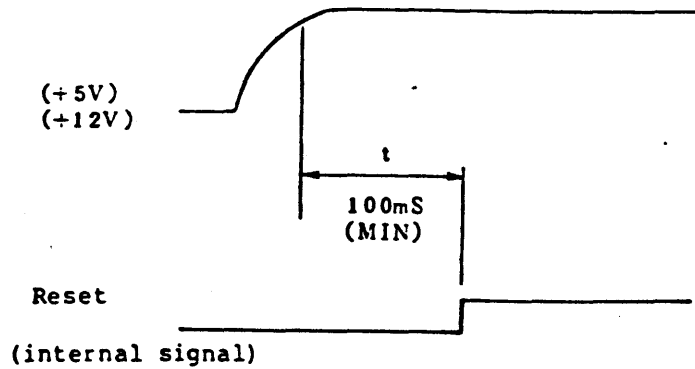

- (2) For $t =$ ms after DEN1 is switched from LOW to HIGH (in the 13 MB mode)
- (3) For $t =$ ms after DEN1 is switched from HIGH to LOW (in the 1/2 MB mode)

3.6.2 Seek Timing

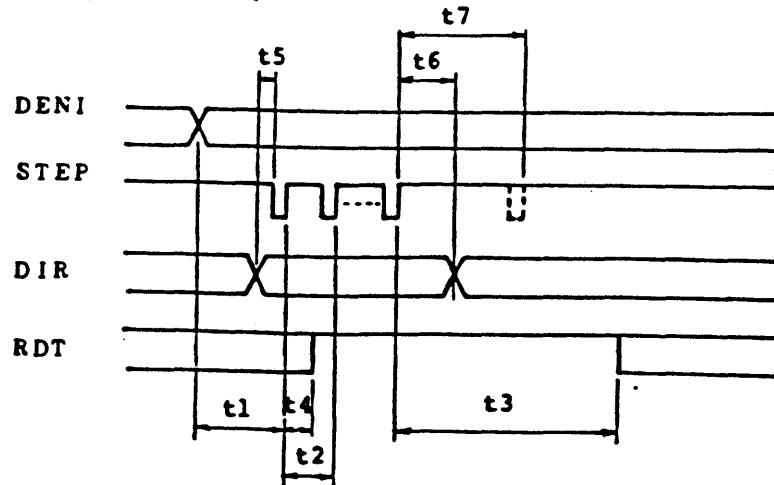

TPI mode	431		135		Unit
Seek mode	Buffered seek	Normal seek	Buffered seek	Normal seek	
t1 (DEN1: H → L)					mS
t1 (DEN1: L → H)					mS
t2 (step rate)	0.5 to less than 3	3 or more	0.5 to less than 9	9 or more	mS
t3	*1	100 (TYP)	*2	15	mS
t4	Not more than 1		Not more than 1		mS
t5	0.4 or more		0.4 or more		S
t6	0 or more		0 or more		S
t7 (for reverse seek)	15 or more		15 or more		mS

*1: $N (3 - t2) + 100$

*2: $N (9 - t2) + 15$

N denotes the number of step pulses.

3.6.3 Track 0 Timing

135 TPI mode

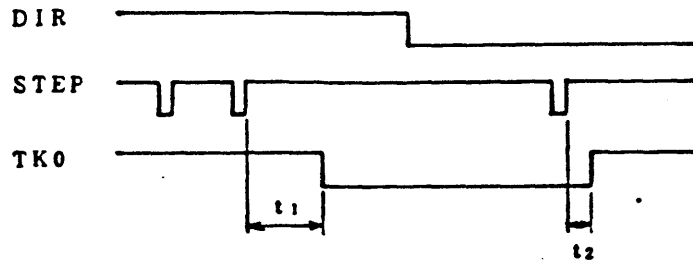

$t_1 = 2.5ms (Max)$

$t_2 = 1ms (Max)$

Note: The values are applicable to the normal mode seek.

431 TPI mode

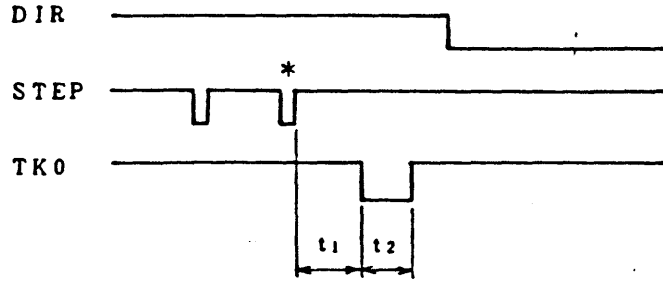

$t_1 = 2.5 \text{ ms (Max)}$

$t_2 = \text{ms (Min)}$

* A pulse for moving 9 steps outward with the head already positioned to TRK0.

Note: The values are applicable to the normal step mode.

3.6.4 Recalibrate Timing

For recalibration, the track 0 signal level is checked every time a step pulse is output. The step pulses are output till the level goes to logic "0".

To ensure recalibration, 263 or more step pulses must be sent with the direction signal set to logic "1". For this, a recalibrate command must be issued twice if $\mu\text{PD72069}$ (recommended controller) is used as an FDC.

Secure a settling time (t_7 in Section 3.6.2) before performing a seek following recalibration.

3.6.5 Side Select Timing

135 TPI mode

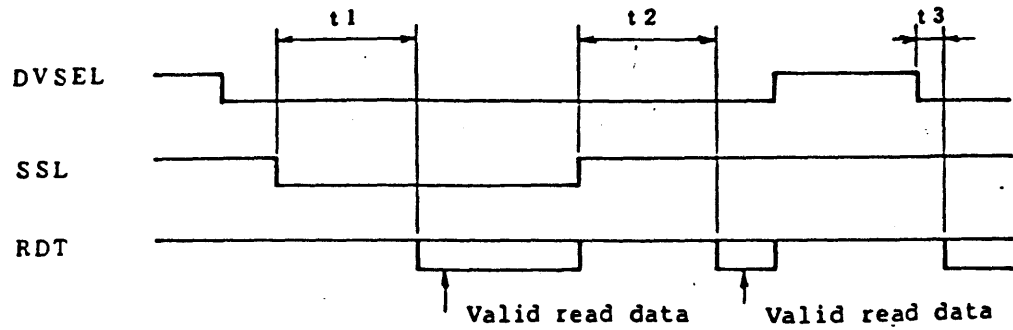

$$t_1 = t_2 = t_3 = 100 \mu\text{S (Max)}$$

431 TPI mode

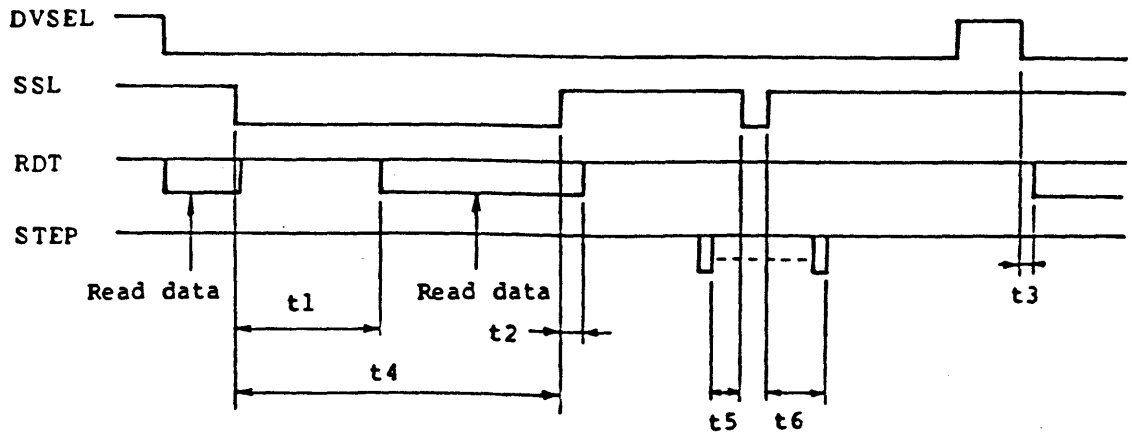

Item	Specification	Unit
t1 (*1)		
t2		
t3 (*2)		
t4		
t6		

*1 When the side is switched.

*2 When the drive select is changed without side change.

3.6.6 Read/Write Timing

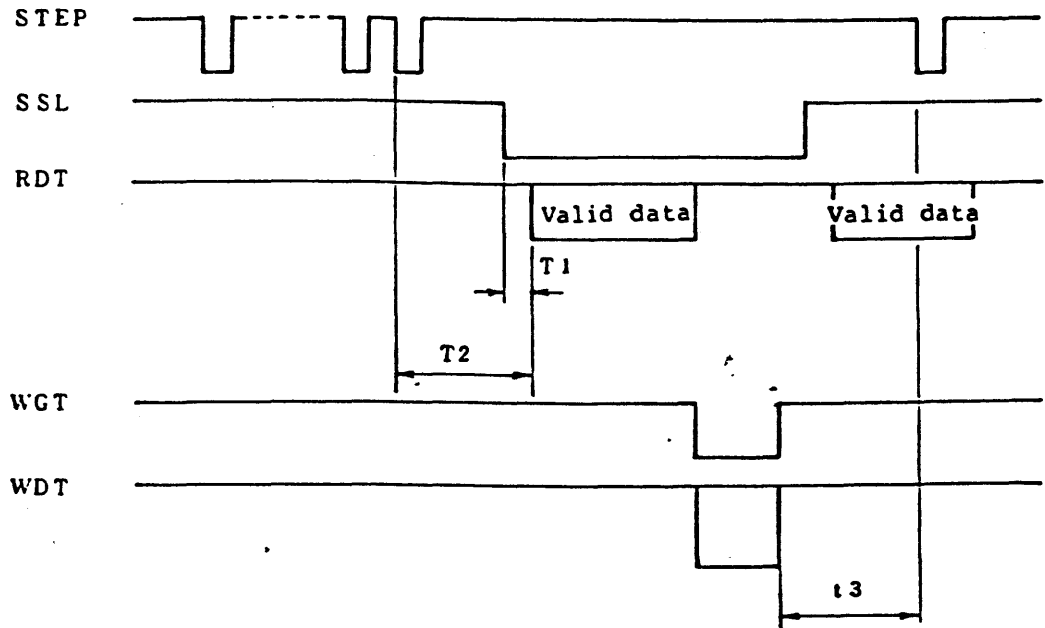

Do not set WGT to LOW for 500 ms (max.) after the MON signal has been switched.

3.7 Power Interface

3.7.1 Input Power Specifications

Table 3.3 shows the dc power specifications for the FDD.

The sequence of each dc power is not necessary.

Table 3.3 Input Power Specifications

Item		+12 V power	+5 V power	
Power		+12 V <u>+10%</u>	+5 V <u>+5%</u>	
Current (*1) mA	Startup	520	300	7.74W
	Seek time average	420	260	6.34W
	Read time average	390	260	5.98W
	Wait time average (MOTOR OFF status)	310	260	5.02W
Ripple voltage (*2)		200 mVp-p or less	100 mVp-p or less	

*1 Average dc power requirement of FDD

*2 Includes a spike voltage.

*3 If the FDD is not in the write (with the interface pin 24 set to LOW) mode, the data are protected irrespective of the dc power ON/OFF.

*4 Do not turn ON/OFF the FDD power directly with a mechanical switch such as a relay and a switch that causes chattering.

*5 The power value is defined at the FDD connector.

4. OPERATING PROCEDURE

The basic operating procedure for the FDD consists of power ON/OFF and media mounting and unmounting.

4.1 Mounting a Medium

- (1) Turn on the dc power.
- (2) Insert a medium slowly into the slot and push it till the eject button pops out.

4.2 Removing a Medium

- (1) Check the FDD read/write operation is completed.
- (2) Press the eject button for automatic medium ejection.

4.3 Display Lamp

The display lamp indicates the FDD status. The lamp is lit in green when the FDD is ready and selected by the DRIVE SELECT signal.

5.2 Installation

The FDD can be installed in the following positions:

- (a) Vertical (display lamp on the bottom)
- (b) Vertical (display lamp on the top)
- (c) Horizontal

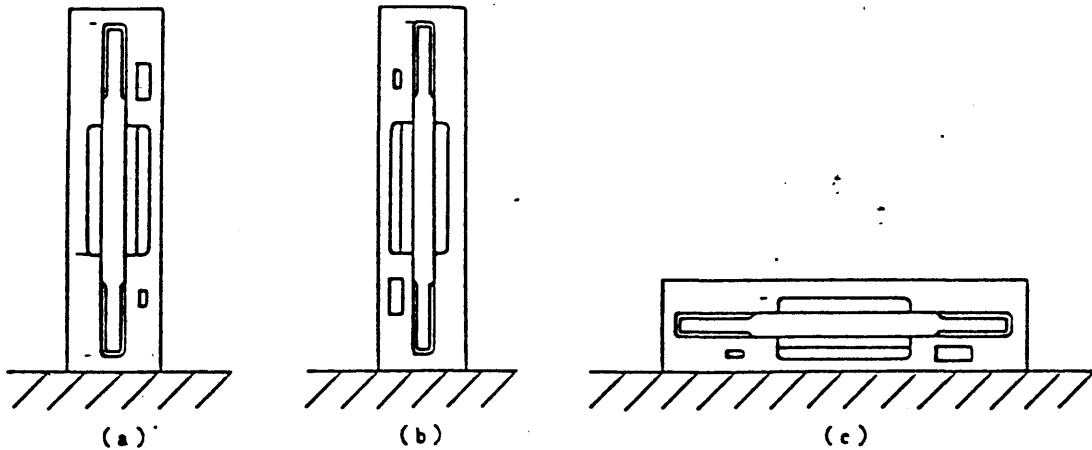

Secure the FDD with M3 mounting screws. Use four mounting screw holes either on the sides or on the bottom. Check the mounting screw length since the mounting screw hole is 3 mm deep.

To prevent an FDD performance drop, observe the range of mounting hole position dimensions and exercise care so that no undue force will be applied to the FDD.

If the FDD is mounted close to a CRT or a power supply, try to minimize the effect of noise from the CRT or power supply.

6. PACKING AND TRANSPORTATION

- (1) Apply the same packing material as used in the delivery or pack the FDD so that the FDD will be spared direct shock.
- (2) During transportation, make sure the FDD is not subjected to excessive shock.