

KB 101™
USER'S GUIDE

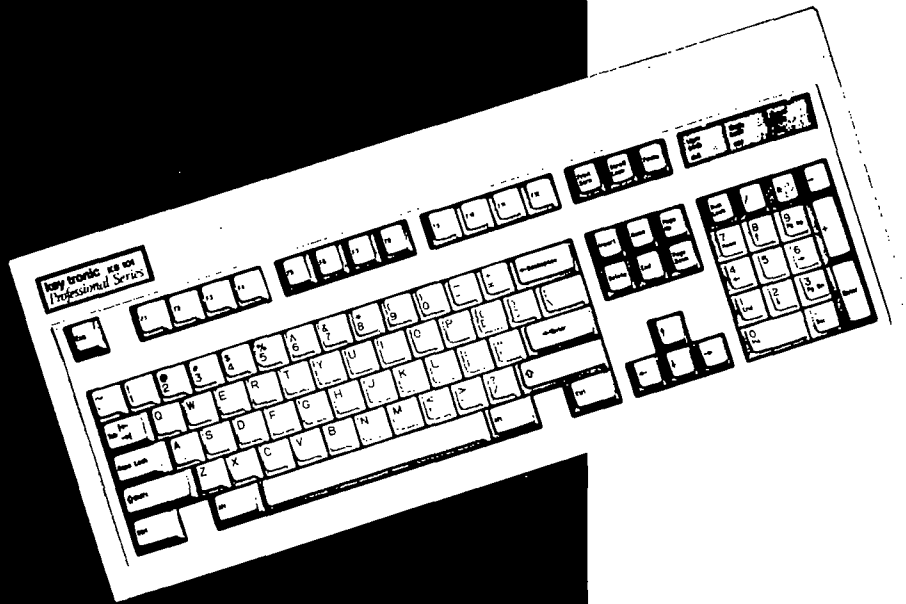

Notices

The information contained in the KB 101 User's Guide is the property of Key Tronic Corporation and may not be copied, photocopied, reproduced, translated or reduced to any electronic medium or machine-readable form without prior written consent from Key Tronic Corporation.

Trademark Notices

PC/XT™ and Personal System/2™ are trademarks and IBM® and PC AT® are registered trademarks of International Business Machines Corporation.

Amstrad™ is a trademark of Amstrad Plc.

KB 101™ is a trademark and Key Tronic® and Key Tronic Professional Series® are registered trademarks of Key Tronic Corporation.

Lotus® and 1-2-3® are registered trademarks of Lotus Development Corporation.

WordStar® is a registered trademark of MicroPro International Corporation.

KB 101 User's Guide

Part Number: KTC 31310-2
Comments or correspondence regarding the KB 101 User's Guide should be directed to:

Key Tronic Corp. Attn: Mktg. Communications
P.O. Box 14687 Spokane, WA 99214-0687

Copyright © 1988, 1991
by Key Tronic Corporation. All rights reserved.

Warning

This equipment generates and uses radio frequency energy and if not installed properly, that is in strict accordance with the manufacturer's instructions, may cause interference to radio and television reception. It has been type-tested and found to comply with the limits for a Class B computing device in accordance with the specifications in CFR 47, Part 15, Subpart B of the FCC Rules, which are designed to provide reasonable protection against interference in a residential installation. However, there is no guarantee that interference will not occur in a particular installation. If this equipment does cause interference to radio or television reception, which can be determined by turning the equipment on and off, the user is encouraged to try to correct the interference by one or more of the following measures:

- Reorient the receiving antenna.
- Relocate the computer with respect to the receiver.
- Move the computer away from the receiver.
- Plug the computer and receiver into a different outlet so that the computer and receiver are on different branch circuits.
- Move the cables connected to the computer to minimize the interference.

Warning

If necessary the user should consult the dealer or an experienced radio/television technician for additional suggestions. The user may find the following booklet, prepared by the Federal Communications Commission, helpful:

"How to Identify and Resolve Radio-TV Interference Problems."

This booklet is available from the U.S. Government Printing Office, Washington, D.C. 20402, Stock No. 004-000-00345-4.

Warning Any changes or modifications not expressly approved by the party responsible for compliance, could void the user's authority to operate this equipment.

This equipment is supplied with a shielded cable to meet FCC Class "B" emission limits.

"THIS DIGITAL APPARATUS DOES NOT EXCEED THE CLASS "B" LIMITS FOR RADIO NOISE EMISSIONS SET OUT IN THE RADIO INTERFERENCE REGULATIONS OF THE CANADIAN DEPARTMENT OF COMMUNICATIONS."

"LE PRÉSENT APPAREIL NUMÉRIQUE N'ÉMET PAS DE BRUITS RADIOÉLECTRIQUES DÉPASSANT LES LIMITES APPLICABLES AUX APPAREILS NUMÉRIQUES DE LA CLASSE "B" PRÉSCRITES DANS LE RÉGLEMENT SUR LE BROUILLAGE RADIOÉLECTRIQUE ÉDICTÉ PAR LE MINISTÈRE DES COMMUNICATIONS DU CANADA."

Table of Contents

Section 1	Introduction	
	Keyboard Description	1-1
	Features	1-3
	User's Guide Overview	1-4
	User's Guide Conventions	1-5
Section 2	Installation	
	Preliminary Steps	2-1
	Keyboard Installation	2-2
	Mode Switch Settings	2-5
Section 3	Using the Keyboard	
	Keyboard Organization	3-1
	Function Key Area	3-2
	LED Panel	3-4
	Numeric Keypad	3-5
	Cursor Control Keypad	3-7
	Typewriter Area	3-8
	Keyboard Height Adjustment	3-11
Section 4	Keyboard Maintenance	
	Cleaning the Keyboard	4-1
	Keyboard Protection Accessories	4-1
	Modifying the Key Feel	4-2

List of Appendices

Appendix A **Technical Information**

Keyboard Interface Information	A-1
Scan Code Processing	A-2
PC/XT Scan Codes	A-3
AT Scan Codes	A-4
Keyboard Specifications	A-5

Appendix B **Customer Support Information**

Technical Assistance	B-1
Return for Repair Procedure	B-3
Limited Warranty	B-5

Appendix C **Glossary**

Glossary Listing	C-1
------------------------	-----

Section 1**INTRODUCTION**

Section 1 provides a description and a list of standard features for the Key Tronic® KB 101™ Professional Series® keyboard. An overview of the User's Guide and conventions used are also presented.

***Keyboard
Description***

The KB 101 Professional Series™ keyboard is a plug-compatible replacement for the IBM PC™, XT™ and AT® Personal Computer keyboards (standard and enhanced), as well as most IBM® compatibles.

Installation is simply a matter of unplugging your existing keyboard and plugging in the KB 101. The KB 101 is switch selectable from XT to AT.

The KB 101 uses the industry-standard 101 key layout and features a smaller enclosure that takes up less desk space than other conventional size keyboards. Keys are placed in easy-to-find locations and keycaps are clearly marked with familiar key legends rather than symbols. Ctrl and Alt keys on each side of the space bar provide additional convenience.

Function keys F1 through F12 and the Escape key are placed on the top row for easier access and more accurate operation. Also together in the top row are special function keys: Print Screen, Scroll Lock, and Pause.

An LED panel in the upper right-hand corner of the keyboard contains status indicators for the Num Lock, Caps Lock, and Scroll Lock keys. In addition to the numeric keypad, a separate cursor control keypad is added with dedicated keys for screen control and cursor movement.

An illustration of the KB 101 keyboard is shown on the next page.

Keyboard
Description

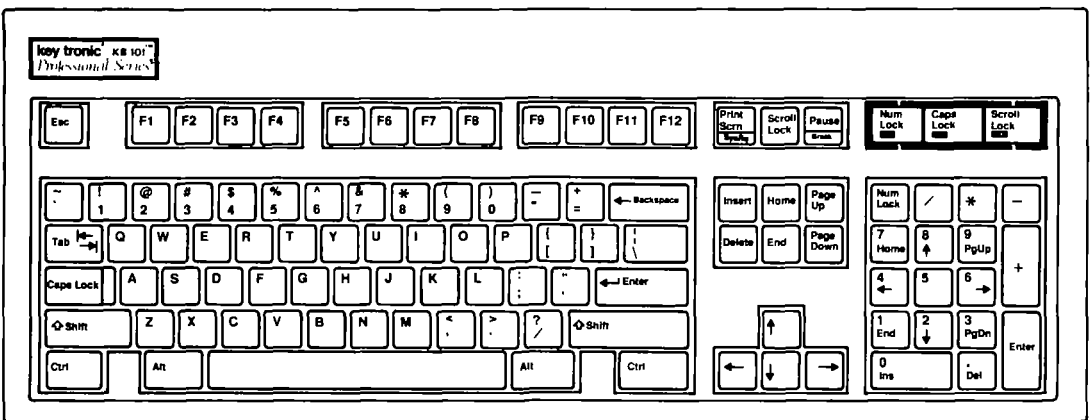

KB 101 Keyboard

Features

Compatibility

The KB 101 is plug-compatible with the IBM PC, XT and AT Personal Computers and most IBM compatibles. No software modifications or special interfaces are needed. With the addition of a PS/2 Cable Adapter Kit, you can use the KB 101 with PS/2™ Models 25, 30, 50, 60 and 80. You can also use the KB 101 with the Amstrad® PC 1512 and PC 1640 computers with an Amstrad Cable Adapter Kit.

Separate Cursor and Numeric Keypads

An additional keypad located between the typewriter area and the numeric keypad contains cursor positioning keys, allowing you to move the cursor while the numeric keypad is in numbers mode. With separate cursor and numeric keypads, you can move around in your spreadsheet or other documents and enter numbers quickly and accurately.

Standard 101 Key Layout

The KB 101 uses the industry-standard 101-key layout and accepts keyboard templates.

Ergonomic Design

Designed for optimum operator comfort, with a low profile design, adjustable legs, and a positive tactile feedback, the KB 101 creates an environment allowing for fast data entry speed, a consistent feel, and low fatigue.

User Modifiable Key Feel

Rubber dome kits that enable you to modify the key feel of your KB 101 are available through the Accessories Catalog or Flyer included with the keyboard. The KB 101 uses a 2.0 ounce rubber dome. If you prefer a lighter feel, you may obtain a 1.0 ounce rubber dome kit. For a firmer feel, order a 2.5 or 3.0 ounce kit.

Features

Key Tronic Reliability

The KB 101 is designed for reliability and durability, using microprocessor electronics and solid-state capacitive switches rated at 100 million keystrokes each. The keyboard is FCC, UL and VDE certified.

User's Guide Overview

This User's Guide provides you with detailed information on how to install and use your keyboard. After the keyboard is installed and you are familiar with its operation, keep the User's Guide as a reference for technical and customer support information.

An overview of the User's Guide is given below.

Section 2, Installation, provides step-by-step instructions for installing the keyboard and setting the mode switches.

Section 3, Using the Keyboard, helps you become familiar with the keyboard layout. Each major area of the keyboard is described.

Section 4, Keyboard Maintenance, describes how to clean the keyboard and how to purchase keyboard enhancement and protection accessories. This section also describes how to change the key feel with a Rubber Dome kit.

*User's Guide
Overview*

Appendix A, Technical Reference, includes keyboard interface information, scan code listings, and a summary of keyboard specifications.

Appendix B, Customer Support Information, describes how to obtain technical assistance and how to return keyboards for repair. The Key Tronic limited warranty is also listed.

Appendix C, Glossary, contains a list of keyboard and technical terms.

*User's Guide
Conventions*

Throughout the User's Guide, initial references to keyboard and technical terms are indicated in ***bold, italic type***. These terms are defined in the glossary in Appendix C.

Section 2

INSTALLATION

Section 2 provides illustrated step-by-step instructions for installing the KB 101™ keyboard. This section also describes how to set the keyboard mode switches.

Preliminary Steps

Ensure that your keyboard box contains the following:

- KB 101 keyboard
- Connecting cord (installed)
- User's Guide with Registration Card
- Accessories Catalog or Flyer

Notify your dealer immediately if any items are missing or damaged. See Appendix B for detailed Customer Support Information.

Please retain the keyboard box for reuse in case you need to return your keyboard for service. The foam end caps are custom designed to protect and secure the keyboard during shipment.

Please complete the registration card included in this User's Guide and return it to Key Tronic. The registration card enables Key Tronic to keep you informed of product upgrades and enhancements.

Keyboard Installation

The KB 101 keyboard is preset to function with *enhanced* PC/XT™, AT® and PS/2™ Models. If your present IBM keyboard has 101 keys it is an enhanced model. *Standard* IBM keyboards have 83 or 84 keys.

Installation for IBM computers having enhanced 101 keyboards is simply a matter of plugging the KB 101 keyboard into the computer. However, if you have an IBM standard model keyboard or an Amstrad computer, you will need to set the keyboard *mode switches* before connecting the keyboard. See Mode Switch Settings later in this section.

To install the KB 101 keyboard, perform the following steps:

- Step 1.** Turn OFF your computer before installing the KB 101 keyboard.

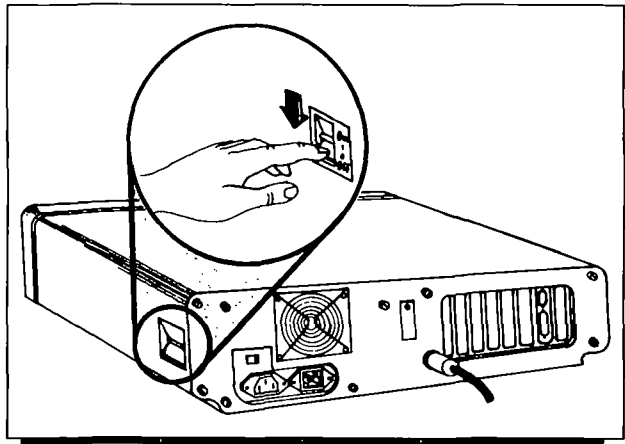

***Keyboard
Installation***

- Step 2.** Unplug your existing keyboard and replace it with your KB 101 keyboard. Insert the 5-pin keyboard connector into the keyboard socket on the rear panel of the system unit. The IBM PC has two receptacles, labelled Keyboard and Cassette, and the IBM XT and AT have a single receptacle as shown below.

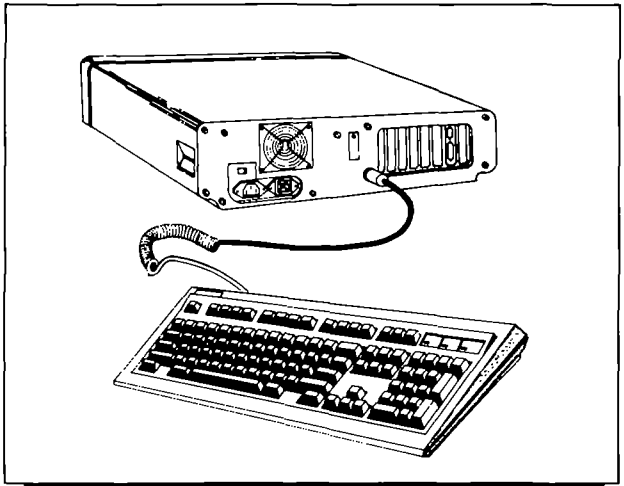

- Step 3.** Place the computer power switch to ON. On power-up, the computer performs a short self-test program.

***Keyboard
Installation***

Upon successful completion of the self-test, the DOS *prompt* is displayed and you can begin using the system.

If you receive a keyboard error message or receive garbled characters on your monitor, check the keyboard cable connection and make sure the mode switches are set properly.

If you need additional assistance call our Product Support Specialists at **1-800-262-6006**. In Canada, call **1-800-348-6006**.

**Mode Switch
Settings**

The KB 101 contains a *mode switch* that allows the keyboard to operate in four modes:

- Enhanced XT, AT and PS/2 (factory setting)
- Standard AT
- Standard PC and XT
- Amstrad

To access the mode switch, remove the plastic mode switch cover on the bottom of the keyboard.

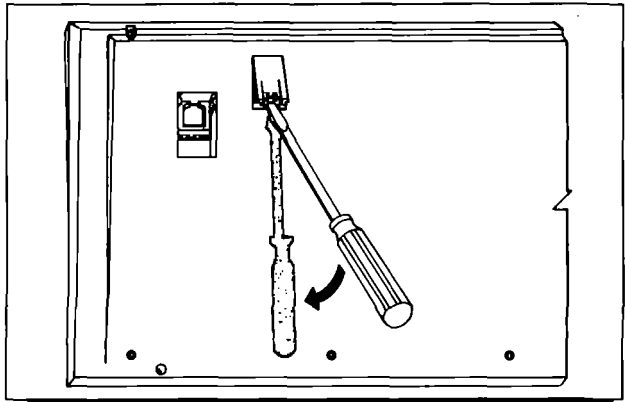

The mode switch consists of eight toggles that are factory preset to OFF, compatible with the enhanced XT, AT and PS/2 Models.

If you have a standard IBM model keyboard (83-key or 84-key keyboard), or an Amstrad PC 1512 or PC 1640, set the switches according to the table on the next page.

Mode Switch Settings

	Enhanced XT/AT and PS/2 Models (Factory Setting)	Switch 1 Switch 2 Switches 3-8	OFF OFF OFF
	Standard AT	Switch 1 Switch 2 Switches 3-8	ON ON OFF
	Standard PC & XT	Switch 1 Switch 2 Switches 3-8	ON OFF OFF
	Amstrad	Switch 1 Switch 2 Switches 3-8	OFF ON OFF

To change a mode switch setting to ON, simply slide the appropriate switch towards the side marked "ON". To change a mode switch to OFF, slide the switch back towards the "number" or OFF side as shown below.

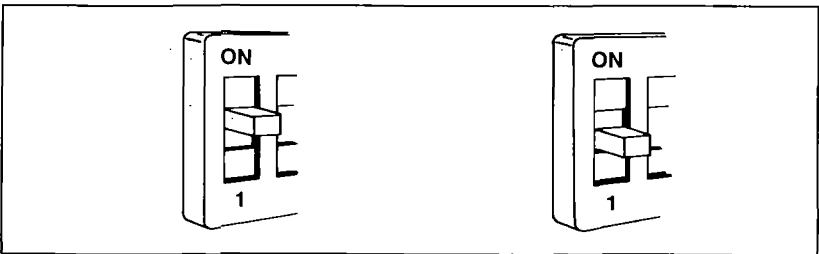

Section 3 identifies the major areas of the keyboard. A description of each area is given and the function of each special, non-character key is explained. Not all programs use the keys in the same ways. Common functions are described here.

Keyboard Organization

The KB 101™ keyboard is divided into five areas:

- Function Key Area
- LED Panel
- Numeric Keypad
- Cursor Control Keypad
- Typewriter Area

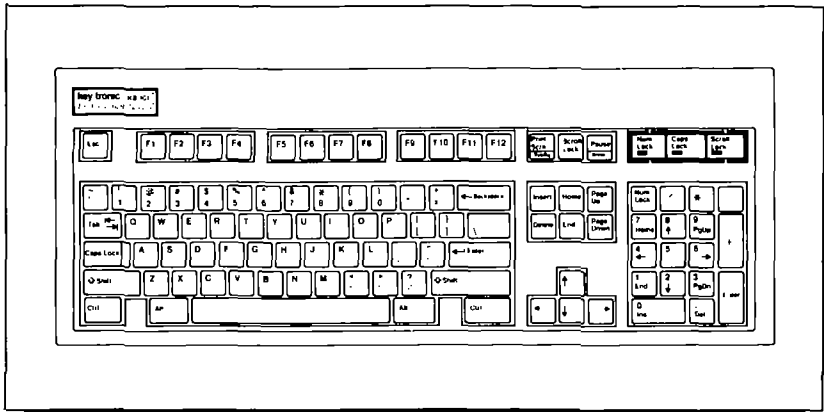

KB 101 Keyboard Layout

Each of these areas is described briefly on the following pages. For additional information on specific key functions refer to the *IBM Guide to Operations* for your particular computer, the *IBM DOS Manual*, or your application program manual.

Function Key Area

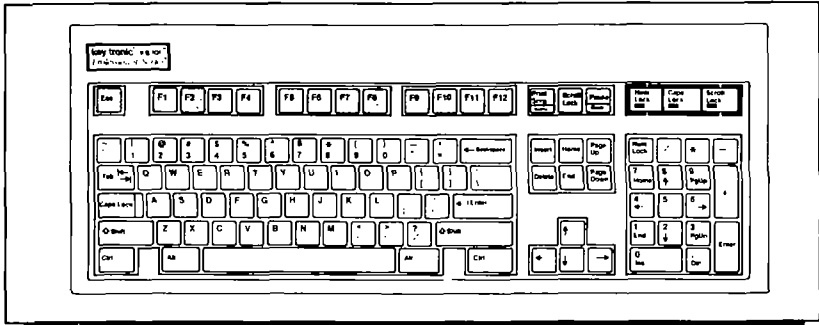

The KB 101 has twelve multi-purpose *function keys*, F1 through F12, located across the top of the keyboard for easy access. The function of each key is defined by the application program you are using.

In addition, the function key area also contains the Escape (Esc), Print Screen (Print Scrn), Scroll Lock and Pause keys. A brief explanation of each of these keys is given below.



The function of the **Escape** (Esc) key varies among applications. It is often used to display menus, to exit a function, or to cancel a command.



The **Print Screen** (Print Scrn) key is a dual-function key. When this key is pressed alone, the data displayed on your monitor is printed.

An Alt-Print Scrn combination performs the **System Request** (Sys Rq) function.

**Function Key
Area**

Note:

The **System Request** function is performed only when the keyboard is configured in AT mode. The System Request function is defined in your operating system or application program manual.



The function of the **Scroll Lock** key varies among applications. Typically, when Scroll Lock is enabled, cursor key movement causes the text on the screen to move (scroll) behind the cursor while the cursor remains stationary. When Scroll Lock is disabled, the cursor moves over the text while the text remains stationary.

When scroll lock is enabled, the Scroll Lock LED is ON. The Scroll Lock LED is described on the next page.



The **Pause** key is a dual-function key. Pressing the Pause key stops screen listings so that you can read the screen. Pressing any key will resume the listing.

A Ctrl-Pause combination performs the **Break function**. Break typically is used to cancel the current operation and terminate the program.

LED Panel

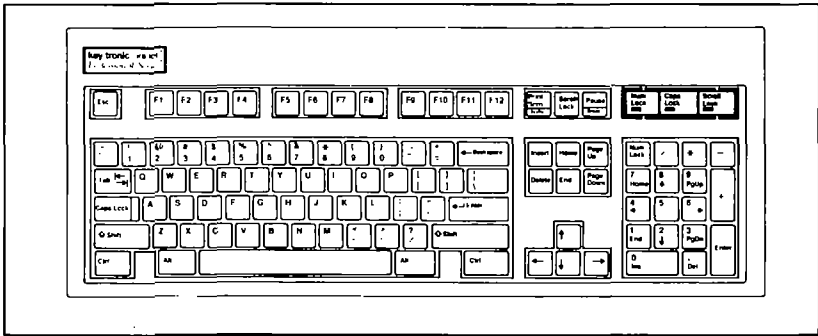

The **Num Lock**, **Caps Lock**, and **Scroll Lock LEDs** are grouped together, making it easy to see if a key function, Caps Lock, for example, is active. The corresponding LED status indicator is activated when you press the Num Lock, Caps Lock or Scroll Lock key. When an LED is illuminated, the function is enabled.

When the particular function is no longer desired, press the key. The function is disabled, and the LED is extinguished.

Note: The status of the Num Lock LED at power-up varies with the model of the **host computer**. The Caps Lock and Scroll Lock functions are disabled at power-up, and their LEDs are OFF.

Numeric Keypad

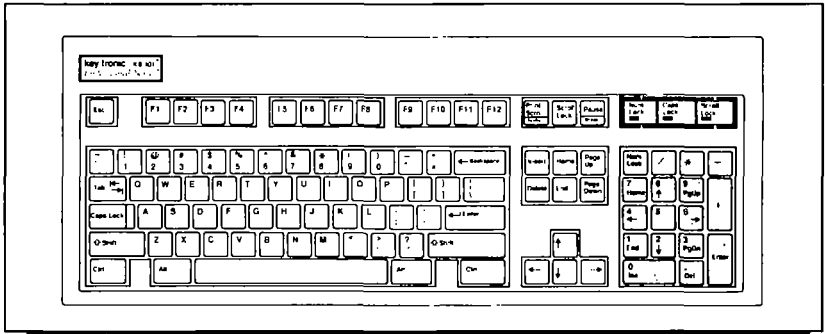

The numeric keypad provides a quick, easy way to enter numeric values while still having a separate cursor control keypad for cursor positioning and edit functions. All four common math function signs: /, *, - and +, are on the numeric keypad.

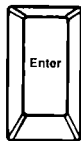

The **Enter** key performs the same function as the Enter key in the typewriter area. It ends a line of text and positions the cursor at the beginning of the following line. It also performs the "Enter" function, instructing the computer to perform a specific command or to start a job.

To switch the numeric keypad between numbers mode and cursor control mode, use the Num Lock key in the upper left-hand corner of the keypad. Depending on the model of the host computer, the numeric keypad may be placed in numbers mode on power-up or a system *reset*.

Numeric Keypad

The Num Lock LED indicates whether the keypad is in numbers mode (LED is ON) or in cursor control mode (LED is OFF).

The grey keys: /, *, -, + and Enter, are active in numbers mode. In most programs, they remain active even when Num Lock is OFF (keypad in cursor control mode).

Note: When the Num Lock LED is OFF and the numeric keypad is in cursor control mode, numbers can still be entered by pressing the Shift key with the desired number.

Also, most programs allow you to use the cursor keys while the numeric keypad is in numbers mode, by pressing Shift with the desired key.

When the numeric keypad is in cursor control mode, it performs the cursor movement, document control, and editing functions marked on the keycaps.

Cursor Control Keypad

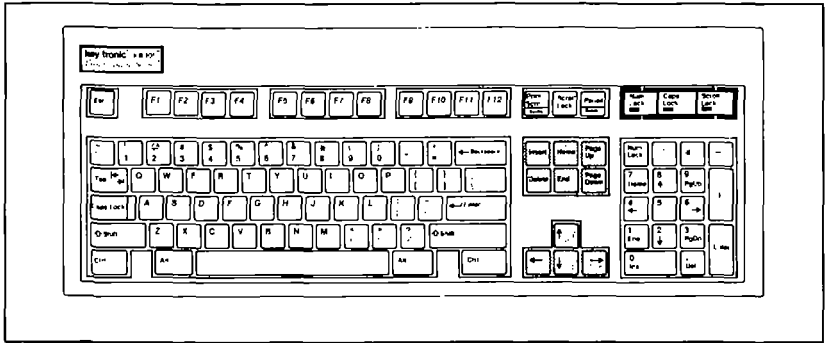

The KB 101 keyboard features a separate cursor control keypad. This keypad is active during all modes of keyboard operation and is especially convenient when the numeric keypad is in numbers mode (Num Lock LED is ON).

The cursor control keypad contains two groups of keys. The top group contains document control and editing keys: Home, End, Page Up, Page Down, Insert and Delete. The bottom group contains cursor movement keys (arrow keys) for positioning the cursor on your screen. If unsure of the functions of these keys, refer to the IBM Guide to Operations for your particular computer, or your application program manual.

Typewriter Area

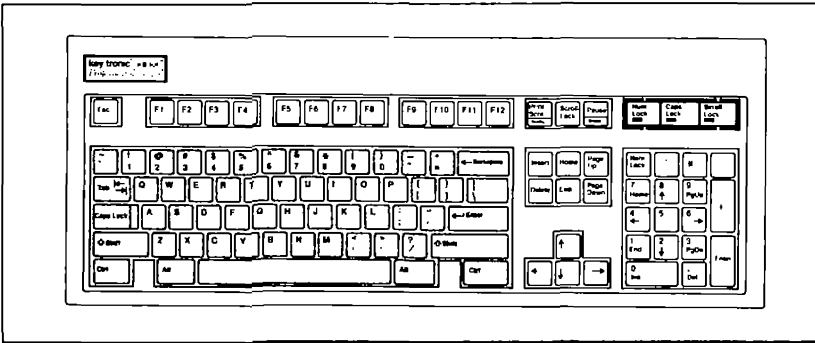

The typewriter area conforms to the industry standard 101 key layout and has an Alt key and Ctrl key on each side of the space bar.

All the white keys in the typewriter area are "typematic"; repeating as long as you hold them down.

Note: If you are used to typing on a typewriter, you may have used a lowercase letter "l" or uppercase letter "I" for the number one. Similarly, you may have used an uppercase letter "O" for the number zero. Because the keyboard sends unique scan codes for each key on the keyboard, the above substitutions can create unpredictable results. Always use numeric keys for one and zero.

**Typewriter
Area**

The non-character keys located in the typewriter area are described below.



The **Backspace** key is used to delete characters. Pressing Backspace moves the cursor one position to the left, removing that character. The function of the Backspace key may vary slightly, depending on the software you are using.

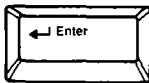

The **Enter** key normally works like a carriage return, moving the cursor to the start of a new line. The key also performs "Enter" functions, instructing the computer to perform a specific command or start a job.

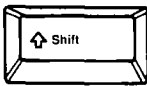

Use either of the two **Shift** keys to enter uppercase letters or to enter the symbol or character shown in the upper position on the keycap. In most application programs, a Shift key may be used together with the numeric keys to enter numbers when the numeric keypad is in cursor control mode.

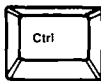

The **Control (Ctrl)** key is used with another key or key combination to perform a command or function. Instructions may be passed to WordStar® files, for example, through Ctrl-key combinations.

Note: To activate a Ctrl-key command, press and hold down the Ctrl key first and then press the second key.

**Typewriter
Area**



The **Alternate (Alt)** key can be used in combination with other keys to obtain different characters or key functions. For example, you can use Alt with certain letter keys to enter BASIC statement keywords quickly. Some application programs use Alt-key combinations. Lotus 1-2-3® uses the Alt key to trigger macro commands.



The **Caps Lock** key enables and disables the capital letters function. The Caps Lock LED in the LED control panel indicates whether the Caps Lock function is active or inactive.

The Caps Lock function only affects the letter keys. Use a Shift key to type a symbol shown on the upper portion of other keys.



The **Tab** key moves the cursor to the right, to the next tab stop. In some applications, such as DOS, a Shift-Tab moves the cursor left, to the previous tab setting.

**Keyboard
Height
Adjustment**

The KB 101 keyboard can be adjusted to two different positions, level and tilted, by positioning the adjustable legs on the bottom of the keyboard. To tilt the keyboard, simply lift the keyboard legs up, snapping them into their self-locking position as illustrated below.

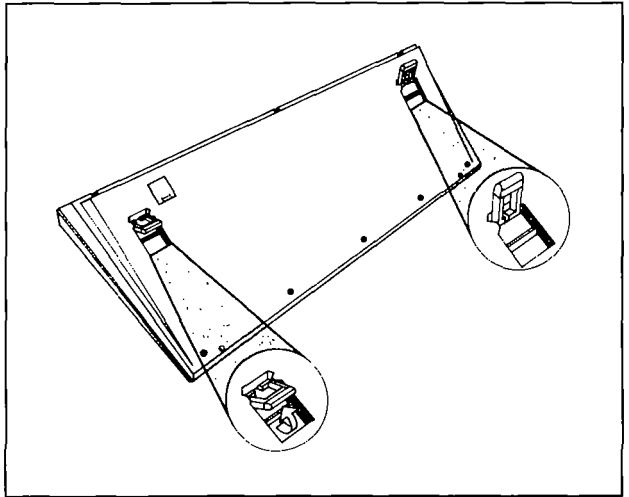

Section 4 describes how to clean the KB 101™ keyboard and how to purchase keyboard protection accessories.

***Cleaning the
Keyboard***

The KB 101 keyboard is designed and manufactured to operate without preventive maintenance. However, you may want to clean the keyboard exterior periodically. Use a mild, household-type cleaner and a soft, damp, lint-free cloth or paper towel.

To prevent spray cleaner from running into the keyboard, spray the cleaning solution onto a cloth or paper towel. Avoid spraying directly onto the keyboard. Be careful not to wipe dirt into the keyboard.

<p><i>Note:</i> Do not use a petroleum-based solvent, as this will damage the plastic keyboard enclosure and painted surfaces.</p>

***Keyboard
Protection
Accessories***

Keyboard protection items such as dust covers, anti-static mats, and mini vacs, can be purchased through the Accessories Catalog or Flyer included in the keyboard shipping box. The catalog or flyer contains order forms and information on a number of accessories to enhance and protect your keyboard.

Modifying the Key Feel

While Key Tronic prides itself on its keyswitch technology that provides a consistent, positive tactile response, some users may prefer the key feel or touch to be slightly firmer or lighter.

Key Tronic offers a “Rubber Dome Kit” allowing you to modify the key feel by changing the rubber domes in your keyboard. (Rubber domes are located underneath the keycaps and control the responsiveness of a key.)

Your KB 101 keyboard is equipped with 2.0-ounce rubber domes from the factory, but can be changed to 1.0, 2.5 or 3.0-ounce rubber domes.

The 1.0-ounce rubber dome kit provides a lighter feel, and the 2.5 or 3.0-ounce kits provide a firmer feel. The kit includes enough rubber domes (75) to modify the feel for all the white keys on the keyboard (with the exception of the space bar), a keycap removal tool and installation instructions.

Refer to the Accessories brochure for ordering and pricing information.

Appendix A TECHNICAL INFORMATION

The Technical Information Appendix includes the following information:

- Keyboard interface information describing the 5-pin DIN connector.
- Overview of how scan codes are processed.
- IBM PC/XT™ and AT® scan code charts.
- Specifications for the KB 101 keyboard.

Keyboard Interface Information

Communications between the keyboard and host computer occur through a shielded keyboard cable. The cable end has a 5-pin *DIN connector* that attaches to the receptacle located on the rear panel of the computer.

The cable contains a logic ground line, power line, and *bi-directional* clock and data lines. Data I/O uses *synchronous, serial* protocol.

An illustration of the 5-pin DIN connector and a table showing the function and signal or voltage of each pin is shown below.

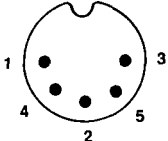
Pin	Function	Signal/ Voltage	Keyboard Connector
1	Clock	TTL	
2	Data	TTL	
3	Not used	----	
4	Ground	0 Vdc	
5	Power	+5 Vdc	

5-pin DIN
Connector

Scan Code Processing

Note: The information that follows gives an overview of how *scan codes* are generated at the keyboard. Refer to the appropriate IBM Technical Reference Manual for detailed information on these topics.

Underneath the keyboard is a grid of electrical circuitry. When a key is pressed, contact is made with the grid, creating a closed circuit. The keyboard microprocessor uses electrical current to constantly scan this grid, even when the keyboard is not in use. Once a closed circuit is detected, the microprocessor encodes the position of the keypress, translates the keypress to an IBM scan code, and transmits this scan code to the host computer. A scan code, sometimes called a "key code", is a numerical value that uniquely identifies each keyboard key.

Each key or keyswitch on the computer is represented by two scan codes: a "down" scan code (*make code*), sent when a key is pressed, and an "up" scan code (*break code*), sent when the key is released. For example, on the IBM PC/XT and PS/2™ Models 25 and 30, keyswitch number "1", the Escape key, produces scan code 01 hexadecimal (hex) on make and scan code 81 hex on break. Break codes are formed by adding 80 hex to the make code.

The IBM AT and PS/2 Models 50, 60, and 80 use a different set of scan codes than the PC/XT. For example, keyswitch number "1" on the AT produces scan code 76 hex on make and scan code F0 76 hex on break. AT break codes are formed by preceding the make code with F0 hex.

101 PC/XT CODES

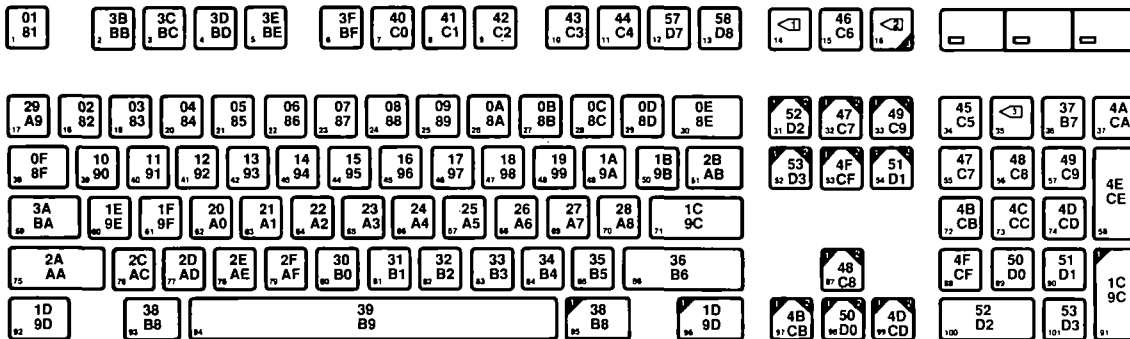

LEGEND

- 1 DOWN CODE
- 2 UP CODE
- 3 SWITCH NUMBER
- ▲ MULTIPLE KEY SPECIAL CASE
- ◁ SINGLE KEY SPECIAL CASE

▲ Up Code and Down Code preceded by 0

▲ LEFT SHIFT CASE
Down Code: E0 AA E0 "Down Code"
Up Code: E0 "Up Code" E0 2A

▲ RIGHT SHIFT CASE
Down Code: E0 B5 E0 "Down Code"
Up Code: E0 "Up Code" E0 36

▲ NUM LOCK ON CASE
Down Code: E0 2A E0 "Down Code"
Up Code: E0 "Up Code" E0 AA

▲ Keys without auto repeat

◁ PRINT SCRNN KEY
Down Code: E0 2A E0 37
Up Code: E0 B7 E0 AA

◁ CONTROL CASE
Down Code: E0 37
Up Code: E0 B7

◁ ALT CASE
Down Code: 54
Up Code: D4

◁ PAUSE KEY
Down Code:
E1 1D 45 E1 9D C5
Up Code: None generated.

◁ BREAK CASE
Active only if Ctrl key is pressed.
Down Code: E0 46 E0 C6
Up Code: None generated.

◁ / KEY
Down Code: E0 35
Up Code: E0 B5

▲ LEFT SHIFT CASE
Down Code: E0 AA E0 35
Up Code: E0 B5 E0 2A

▲ RIGHT SHIFT CASE
Down Code: E0 B6 E0 35
Up Code: E0 B5 E0 36

101 AT SCAN CODES

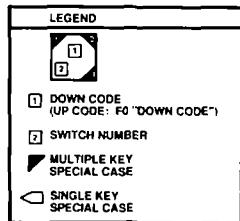
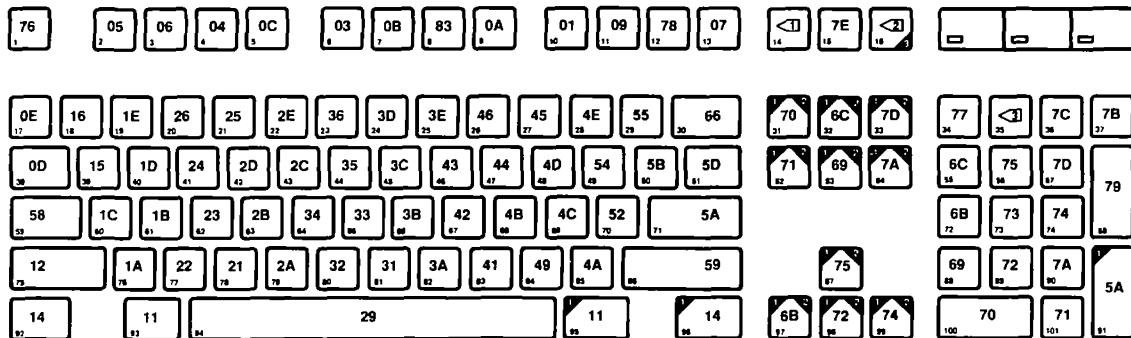

Up Code and Down Code preceded by E0

LEFT SHIFT CASE
Down Code: E0 F0 12 E0 "Down Code"
Up Code: E0 F0 "Down Code" E0 12

RIGHT SHIFT CASE
Down Code: E0 F0 59 E0 "Down Code"
Up Code: E0 F0 "Down Code" E0 59

NUM LOCK ON CASE
Down Code: E0 12 E0 "Down Code"
Up Code: E0 F0 "Down Code" E0 F0 12

Keys without auto repeat

<1 PRINT SCRNN KEY
Down Code: E0 12 E0 7C
Up Code: E0 F0 7C E0 F0 12

CONTROL CASE
Down Code: E0 7C
Up Code: E0 F0 7C

ALT CASE
Down Code: 84
Up Code: F0 84

<2 PAUSE KEY
Down Code:
E1 14 77 E1 F0 14 F0 77
Up Code: None generated.

BREAK CASE
Active only if Ctrl key is pressed.
Down Code: E0 7E E0 F0 7E
Up Code: None generated.

<3 / KEY
Down Code: E0 4A
Up Code: E0 F0 4A

LEFT SHIFT CASE
Down Code: E0 F0 12 E0 4A
Up Code: E0 F0 4A E0 12

RIGHT SHIFT CASE
Down Code: E0 F0 59 E0 4A
Up Code: E0 F0 4A E0 59

**Keyboard
Specifications**

The KB 101 keyboard has the following specifications:

Electrical Data:

Max. input power	350 mA max. @ +5 Vdc
Rollover	N-key rollover (NKRO)
Serial data output	Synchronous 8-bit data

Mechanical Data:

Key total travel	0.150 in. (3.81 mm)
Key activating force	2.0 oz. (55 grams)
Key color	Fog (ABS 2500) Sea Mist (ABS 20779)
Enclosure color	Driftwood (ABS 22061)
Switch reliability	100 million MCBF

Mode Switch Settings:

	1	2	3-8
Enhanced XT/AT, PS/2	Off	Off	Off
Standard AT	On	On	Off
Standard PC and XT	On	Off	Off
Amstrad	Off	On	Off

Environmental Data:

Operating temp.	0 to 55 degrees C
Non-operating temp.	-40 to 70 degrees C
Relative humidity	20% to 95%
Altitude	-1,000 ft. to +12,000 ft.

The Customer Support Information Appendix includes the following information:

- How to obtain technical assistance from Key Tronic's Product Support Specialists.
- Instructions on returning keyboards to Key Tronic for repair or replacement.
- The three-year limited warranty for the KB 101™ keyboard.

Technical Assistance

Key Tronic makes every attempt to ensure that you have purchased a keyboard of unsurpassed quality. Key Tronic Professional Series® keyboards undergo rigorous testing and are rated at 100 million keystrokes. The KB 101 User's Guide is written and designed to provide you with complete, accurate and easy-to-understand instructions on using your keyboard. We encourage you to use this User's Guide as your primary source of information about the keyboard.

For additional support, Key Tronic Product Support Specialists are available to assist you from 7:00 AM through 3:00 PM PST, Monday through Thursday and from 7:00 AM through 12:00 Noon PST on Friday. Their telephone number is listed below.

<p>Key Tronic Product Support 1-800-262-6006 (U.S.) Toll Free 1-800-348-6006 (In Canada) Toll Free (509) 927-5515 (outside U.S. or Canada)</p>
--

***Technical
Assistance***

European customers who need technical assistance or encounter keyboard problems should contact an authorized Key Tronic Distributor. The dealer you purchased your keyboard from can provide you with the name and address of the Key Tronic Distributor nearest you.

Your Key Tronic Distributor will contact a Customer Service Representative from Key Tronic Europe who will determine whether a keyboard has to be returned to Key Tronic for repair. Upon authorization of return, your distributor will give you shipping instructions.

Canadian Customer Support

Canadian customers needing keyboard service or repair should contact our KT Services office in Toronto. They can be reached at (416) 446-1669.

***Return for
Repair
Procedure***

If a keyboard proves to be defective you may return it to Key Tronic for repair. To qualify for "in-warranty repair", proof-of-date-of-purchase must be included with the returned keyboard.

Before returning the keyboard, contact Key Tronic Product Support to make sure that the problem cannot be solved over the telephone.

The following steps explain the procedures for returning your keyboard:

- Step 1.** Call Key Tronic Product Support for a ***Return Authorization*** (RA) number. At that time, the Product Support Specialist will obtain your name, address and phone number, the keyboard model and serial number, and a description of the problem. The address of the nearest repair center will be given to you.
- Step 2.** Carefully pack the keyboard in its original shipping container if possible. If the original container is not available, wrap the keyboard in non-static material such as newspaper and pack it in a sturdy cardboard box. Please be sure the RA number is visible on the outside of the box on the shipping label.

Note: To qualify for "in-warranty" repair service on your keyboard, a copy of the sales receipt or invoice showing the date purchased must accompany the keyboard.

***Return for
Repair
Procedure***

Step 3. Keyboards returned to Key Tronic for repair must be shipped prepaid. It is recommended that the keyboard be insured when shipped.

Note: Key Tronic will not accept units without a Return Authorization Number posted on the outside of the shipping carton.

For keyboards that are repaired under warranty, they will be shipped back to you by prepaid UPS or equivalent service.

For "out of warranty" keyboards, follow the steps listed above. Repairs will be made at your expense. Normal turn-around is 10 working days on prepaid returns, subject to availability of parts. Keyboards will be returned to you at your expense by UPS or equivalent service unless otherwise specified or requested.

**Limited
Warranty**

Key Tronic Corporation warrants the products which it manufactures to be free from defects in materials and workmanship for a period of three (3) years from the date of purchase from Key Tronic or an authorized Key Tronic dealer. This warranty is limited to such purchaser and is not transferable.

During the three (3) year warranty period, Key Tronic will repair or replace, at its option, any defective products or parts at no additional charge, provided that the product is returned, shipping prepaid, to Key Tronic, an authorized dealer or an authorized service location. The purchaser is responsible for insuring any returned product and assumes the risk of loss during shipping. All replaced parts and products become the property of Key Tronic.

Proof-of-purchase showing the date of purchase must be provided by the purchaser when requesting that warranty work be performed. The purchaser may request information on how to obtain warranty service by contacting an authorized dealer or writing to Key Tronic, P.O. Box 14687, Spokane, WA, 99214, U.S.A. or by calling **1-800-262-6006**, or, in Canada, **1-800-348-6006**. If calling from outside the continental U.S.A. or Canada, call Spokane, Washington, U.S.A., **(509) 927-5515**.

This limited warranty does not extend to any products which have been damaged as a result of accident, misuse, abuse, or as a result of service or modification by anyone other than Key Tronic, an authorized dealer or an authorized service location. This limited warranty does not extend to the use of this product with any equipment other than the equipment for which it is designed.

**Limited
Warranty**

EXCEPT AS EXPRESSLY SET FORTH ABOVE, NO OTHER WARRANTIES ARE EXPRESSED OR IMPLIED, INCLUDING, BUT NOT LIMITED TO, ANY IMPLIED WARRANTIES OR MERCHANTABILITY OR FITNESS FOR A PARTICULAR PURPOSE. KEY TRONIC EXPRESSLY DISCLAIMS ALL EXPRESSED OR IMPLIED WARRANTIES NOT STATED HEREIN. IN THE EVENT THE PRODUCT IS NOT FREE FROM DEFECTS AS WARRANTED ABOVE, THE PURCHASER'S SOLE REMEDY SHALL BE REPAIR OR REPLACEMENT AS PROVIDED ABOVE. UNDER NO CIRCUMSTANCES WILL KEY TRONIC BE LIABLE TO THE PURCHASER OR ANY USER FOR ANY DAMAGES, INCLUDING ANY INCIDENTAL OR CONSEQUENTIAL DAMAGES, EXPENSES, LOST PROFITS, LOST SAVINGS, OR OTHER DAMAGES ARISING OUT OF THE USE OF, OR INABILITY TO USE, THE PRODUCT.

Some states do not allow the exclusion or limitation of incidental or consequential damages for consumer products, and some states do not allow limitations on how long an implied warranty lasts, so the above limitations or exclusions may not apply to you.

This limited warranty gives you specific legal rights, and you may also have other rights which vary from state to state.

Appendix C GLOSSARY

This glossary defines a number of keyboard and technical terms used throughout this User's Guide.

Glossary Listing

ASCII	ASCII is an acronym for American Standard Code for Information Interchange. It is a standard character set and coding scheme using unique, seven-bit values (eight bits with parity check) to represent letters, numbers, spaces, symbols, and special control codes.
Bi-directional	A method of data communication that allows data flow in both directions between the host computer and the keyboard.
Break Code	The scan code produced when a key is released. Also referred to as an "up" scan code.
Break Function	The Break function is the secondary function of the Pause key. To enable the Break function, press and hold the Ctrl key, then press the Pause key. Typically, Ctrl-Pause ends the current application and returns you to the DOS prompt.

**Glossary
Listing**

Caps Lock	Pressing this key enables or disables the uppercase letters function. Caps Lock affects only the alpha characters. The LED on the Caps Lock key indicates whether the function is enabled (LED ON) or disabled (LED OFF).
Cursor	The symbol, usually an illuminated box or blinking underline, that indicates where the next data entry will appear on the screen.
DIN Connector (5-Pin)	Provides the interface between the keyboard and the host computer. It contains data and clock signals and ground and power voltages.
DOS	Disk Operating System. Usually referred to as the "operating system". DOS contains a group of programs that the computer uses to input and output data, perform file operations and control application programs.
Enhanced Keyboard	A 101-key keyboard introduced by IBM in 1986 that recognizes additional scan codes not previously used.
Function Keys	Special keys located across the top of the keyboard (F1 through F12) that perform functions specific to the software being used.

***Glossary
Listing***

Host Computer	The computer to which the keyboard is connected. This could be an IBM PC™, XT™, AT®, PS/2™, or an Amstrad™ PC 1512 or PC 1640.
Keyboard Interface	The KB 101™ keyboard uses a 5-pin DIN connector to connect to the host computer. This connection carries the signals necessary for the keyboard and host computer to communicate.
LED	Light Emitting Diode. The KB 101 keyboard contains three LEDs that are used to show the status of the Num Lock, Caps Lock and Scroll Lock keys. Each LED illuminates when the function is active.
Make Code	The scan code produced when a key is pressed. Also referred to as a "down" scan code.
Mode Switch	The mode switch consists of eight ON/OFF toggles housed within the keyboard. Different switch settings allow the KB 101 keyboard to be compatible with the IBM PC, XT, AT and PS/2 Models, and the Amstrad PC 1512 and PC 1640 computers.

**Glossary
Listing**

Num Lock	Pressing this key enables or disables the numeric keypad. When the numeric keypad is enabled, the LED on the Num Lock key is ON and the keypad is used to enter numbers. When numeric mode is disabled, the LED on the Num Lock key is OFF and the keypad is placed into cursor control mode.
Prompt	The symbol displayed on the screen that indicates the computer is ready to receive an instruction.
RA Number	Return Authorization Number. You must obtain this number from Key Tronic Customer Support before returning a keyboard for repair.
Reset	The process of restarting the host computer when the computer is already on, by pressing the Ctrl-Alt-Del keys simultaneously. Also called a "warm boot".
Scan Code	A numerical value that uniquely identifies each key on the keyboard. Each key is represented by a "down" scan code, generated when the key is pressed, and a corresponding "up" scan code, generated when the key is released.

***Glossary
Listing***

Scroll Lock	Pressing this key enables or disables the Scroll Lock function. When Scroll Lock is active, the Scroll Lock LED is ON.
Scrolling	To move data on the screen up or down, so that parts of the document outside the screen area, or window, move into view.
Serial Data	Data that is transmitted in sequence, one bit at a time, rather than an entire byte (group of bits) at a time.
Standard Keyboard	An 83-key keyboard introduced by IBM in 1981 for the IBM PC or an 84-key keyboard for the IBM AT.
Synchronous	A method of data communication in which a group of characters is sent as a continuous stream of bits. The characters, data bits, are sent at a fixed rate, with the transmitter and receiver synchronized (clock controlled). This eliminates the need for start and stop bits.