

The IBM logo consists of the letters "IBM" in a bold, white, sans-serif font, centered within a dark gray square.

Systems Reference Library

General Information – Binary Synchronous Communications

This publication describes the Binary Synchronous Communications (BSC) procedures in general terms. The major topics covered are: BSC concepts (including transmission codes and data-link operation), message formats, additional data-link capabilities, and planning considerations. The reader should have a general understanding of basic data processing principles.

A comprehensive listing of all related publications and their abstracts is provided in the *IBM SRL Bibliography Supplement—Teleprocessing*, GA24-3089.

Preface

This publication is intended as a general introduction to binary synchronous communications (BSC) procedures. It describes the capabilities and flexibility inherent in BSC, including available options.

This publication discusses BSC in seven main sections, which include:

- “Introduction,” which defines the concept of the data link.
- “BSC Concepts,” which defines the transmission codes available and discusses the operation of the data link.
- “Message Formats for Basic Operation,” which defines heading and message formats and discusses them in detail.
- “Additional Data Link Capabilities,” which describes BSC capabilities available as options on some stations.
- “Planning Considerations for BSC,” which describes communications network factors that must be considered in planning for BSC.
- “Planning Considerations for BSC Intermix,” which describes the conditions that allow different types of BSC stations to be included in the same telecommunications network.
- “Planning Considerations for BSC Point-to-Point Intermix,” which describes communications capabilities that allow different types of BSC stations to be included in the same point-to-point network.

Also included are a Glossary and Index.

For detailed information on implementation of BSC relating to a specific machine or system, consult the SRL manuals pertaining to the specific unit.

Certain capabilities described in this manual, while supported by IBM, may not be available at the time this book is published.

Abbreviations

ACK	positive acknowledgment
BCC	block-check character
BSC	binary synchronous communications
CRC	cyclic redundancy checking
EBCDIC	Extended Binary Coded Decimal Interchange Code
EOT	end of transmission
LRC	longitudinal redundancy checking
NAK	negative acknowledgment
SYN	synchronous idle
USASCII	United States of America Standard Code for Information Interchange
VRC	vertical redundancy checking

Third Edition (October 1970)

This is a reprint of the Second Edition, incorporating changes released in Technical Newsletter GN27-3058.

Changes are periodically made to the information herein; before using this publication in connection with the operation of IBM Systems or equipment, refer to the latest SRL Newsletter for the editions that are applicable and current.

Requests for copies of IBM publications should be made to your IBM representative or to the IBM branch office serving your locality.

This manual has been prepared by the IBM Systems Development Division, Publications Center, Department E01, P.O. Box 12275, Research Triangle Park, North Carolina 27709. A form for reader's comments is provided at the back of this publication. If the form has been removed, comments may be sent to the above address.

Contents

Introduction	5	Timeouts	21
Data-Link Concept	5	Transmit Timeout	21
Point-to-Point Data Link	5	Receive Timeout	21
Multipoint Data Link	5	Disconnect Timeout	22
Continue Timeout		Continue Timeout	22
BSC Concepts	7	Additional Data Link Capabilities	23
Transmission Codes	7	Transparent-Text Mode	23
Operation of the Data Link	7	Limited Conversational Mode	23
Polling and Selection	7	Switched-Network (Dial-Up) Operation	23
Message Blocks	7	Leading Graphics	24
Error Checking	9	Planning Considerations For BSC	25
VRC/LRC	9	Planning For a Multipoint Data Communications Network	25
CRC-12/CRC-16	9	Communications Over Switched (Dial-Up) Facilities	25
EOT/NAK Pad Format Check	10	Communications Over Voice-Grade Lines	25
Data-Link Control	11	Situation	26
SYN--Synchronous Idle	12	Scope	26
SOH--Start of Heading	12	EBCDIC	26
STX--Start of Text	12	USASCII	27
ETB--End of Transmission Block	12	Six-Bit Transcode	27
ITB--End of Intermediate Transmission Block	12	Transparent Data	27
ETX--End of Text	12	Summary	27
EOT--End of Transmission	12	Identifying a Code-Sensitive Channel	27
ENQ--Enquiry	13	Recovery	29
ACK 0, ACK 1--Affirmative Acknowledgment	13	Communications Over Wideband Channels	29
WACK--Wait Before Transmit Positive Acknowledgment	13	Planning Considerations For BSC Intermix	31
NAK--Negative Acknowledgment	13	BSC Intermix	31
DLE--Data-Link Escape	13	BSC Intermix Rules	31
RVI--Reverse Interrupt	13	Planning Considerations For BSC Point-to-Point Intermix	34.1
TTD--Temporary Test Delay	13	Intermix Rules	34.1
DLE EOT--Disconnect Sequence for a Switched Line	15	Input/Output and Format Restrictions	34.1
Alternating Affirmative Acknowledgments	15	System/360 Model 20-to-2770 or 2780 (Switched Line)	34.1
Message Formats For Basic Operation	17	Abort Sequence	34.1
Headings	17	Buffer Limitations (2770)	34.2
Text	17	Error Checking (2770)	34.2
Point-to-Point Operation (With Contention)	18	Procedures For Establishing a Call (System/360 Model 20)	34.2
Multipoint Operation (Centralized)	18	Glossary	35
Additional Format Considerations	19	Index	37
Sync Patterns	19		
Character Phase	19		
Bit Phase	21		
Message Sync	21		
Pad Characters	21		

Illustrations

<i>Figure</i>	<i>Title</i>	<i>Page</i>	<i>Figure</i>	<i>Title</i>	<i>Page</i>
1	Transmission of Binary Coded Data (EBCDIC)	5	19	Channels with C4 Conditioning	25
2	EBCDIC Character Assignments (Part 1 of 2)	8	20	Recovery Characteristics of Western Electric Data Set 201B	26
3	USASCII Character Assignments (Part 1 of 2)	10	21	Procedure for Code Sensitivity Testing	28
4	Six-Bit Transcode Character Assignments	11	22	BSC Intermix—Multipoint	32
5	Error Checking Capabilities	12	23	BSC Intermix—Switched Point-to-Point	33
6	Character Conversion Chart	12	24	Feature Capabilities	34
7	Use of WACK, RVI, and TTD	14	25	Feature Restrictions for BSC Point-to-Point Intermix	34.2
8	Block Check Character Accumulation—Entire Transmission	17	26	Establishing a Call (System/360-to-System/360)	34.3
9	Block Check Character Accumulation—Heading Only	17	27	Transmission Fails to Start (System/360-to-System/360)	34.4
10	Use of ENQ to Terminate Heading	17	28	Transmission Unable to Continue (System/360-to-System/360)	34.4
11	Format of Last Text Block	18	29	Transmission Fails to Start—Manual Answer (2770 or 2780-to-System/360)	34.5
12	Format of Normal Text Block	18	30	Transmission Fails to Start—Automatic Answer (2770 or 2780-to-System/360)	34.5
13	Format of Block Ended with Forced Error Condition	18	31	Transmission Unable to Continue (2770 or 2780-to-System/360)	34.6
14	Complete Initialization Phase	18	32	Transmission Fails to Start—Manual Answer (System/360-to-2770 or 2780)	34.6
15	Multipoint Initialization Sequences	19	33	Transmission Fails to Start—Automatic Answer (System/360-to-2770 or 2780)	34.7
16	Typical Data Link Message Traffic (Centralized Multipoint Operation)	20	34	Transmission Unable to Continue (System/360-to-2770 or 2780)	34.7
17	Transparent Data Block	23			
18	Limited Conversational Mode	24			

The Binary Synchronous Communications (BSC) procedure provides a set of rules for synchronous transmission of binary-coded data. BSC expands the transmission capabilities of present and future teleprocessing facilities through its ability to accommodate a variety of transmission codes. Also available is a transparency feature that allows transmission of control characters and various forms of raw data within the normal message format without any associated control or graphic significance. BSC is capable of accommodating a broad range of medium and high-speed equipment.

All data in BSC is transmitted as a serial stream of binary digits (zero and one bits—see Figure 1). Synchronous communications means that the active receiving station on a communications channel operates in step with the transmitting station through the recognition of a specific bit pattern (sync pattern) at the beginning of each transmission. This manual describes BSC transmission codes, data-link control and operations, checking, standard message formatting, optional capabilities, and physical planning.

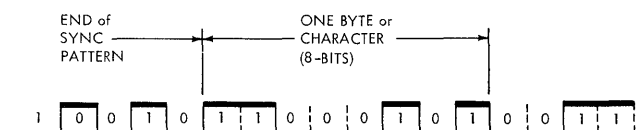

Note:
The number of bits per character is dependent on the code set and checking method used.

Figure 1. Transmission of Binary Coded Data (EBCDIC)

DATA-LINK CONCEPT

A data link consists of the communications lines, modems, and other communications equipment arranged for data, used in the transmission of information between two or more stations. The terminal equipment making up a station can vary from a basic send/receive reader and printer to a control unit with several input and output devices attached.

The communications facilities may be obtained from communications common carriers, or equivalent facilities

may be provided by the customer. The specific data set equipment used at each channel termination point (station) is determined by the type of communications channel and the operational speed of the terminal equipment located at each station.

All transmissions are sent over the line as a sequence of binary-coded signals. Control of the data link is accomplished by the transmission and recognition of special line-control characters. These characters are described in the BSC Concepts section under the heading Data-Link Control.

Point-to-Point Data Link

A point-to-point data link consists of a communications facility between only two stations. All transmissions over the data link must be between the two stations operating on the data link. The point-to-point link can be established over leased (nonswitched) communications lines or a switched network. On a leased line (permanent-type connection), the transmissions are always between the same two stations. On a switched network, the data link is disconnected after the two stations complete their transmissions. A new data link is created for each subsequent transmission by standard dialing procedures (manual or automatic). The new data link may be established with any other station in the network.

Multipoint Data Link

For multipoint operation, one station in the network is always designated as the control station. The remaining stations are designated as tributary stations. The control station controls all transmissions within the multipoint data link, which is normally established over leased (non-switched) lines. This is called a centralized multipoint operation. The control station initiates all transmissions by selecting or polling a tributary station. (Polling and selection are defined in the BSC Concepts section under Operation of the Data Link.) Any transmission over the data link is between the designated control station and one of the tributary stations. The other stations in the network are in passive monitoring mode.

The major function of BSC is to effect the orderly transfer of data from one location to another using communications facilities. This data is transferred as binary-coded characters (0 bits and 1 bits) comprising text information (message body) and/or heading information (message identification and destination). In addition, data-link control characters are required with each message to delimit various portions of the message and control its transmission.

TRANSMISSION CODES

The BSC procedures can accommodate three specific transmission code sets. Each of these code sets consists of graphic characters (numeric, alphabetic, special), functional characters (e.g., HT—horizontal tab, DEL—delete), and data-link control characters (e.g., SOH—start of heading, STX—start of text). Each code provides different capacities for total graphic and functional assignments. These capacities reflect the flexibility of each of these codes and are as follows:

- EBCDIC (Extended Binary Coded Decimal Interchange Code)—256 assignment positions, Figure 2.
- USASCII (United States of America Standard Code for Information Interchange)*—128 assignment positions, Figure 3.
- Six-Bit Transcode—64 assignment positions, Figure 4.

When any one of these code sets is used with transparent mode, the flexibility of the telecommunications system is further increased since all possible bit configurations are treated as “data only” within transparent text. For this mode of operation, all assignment restrictions are removed from the code set being used. Thus the parity bit is also available as a data bit when transmitting transparent USASCII-coded data. This additional BSC capability means that within the standard message format (see the Message Formats for Basic Operation section), any type of coded information can be handled using transparent-text mode. Transparent-text mode is described in the Additional Data Link Capabilities section.

OPERATION OF THE DATA LINK

The data link can be designed to operate either point-to-point (two stations) or multipoint (two or more stations). For point-to-point operation a contention situation exists,

whereby both stations can attempt to use the communications line simultaneously. To minimize this possibility, a station bids for the line using the ENQ (enquiry) control character. The SYN SYN ENQ sequence (SYN SYN represents the synchronous idle characters) provides a concise signal for requesting control of the line, and thus leaves a maximum amount of time for line monitoring. If simultaneous bidding occurs, one station must persist in its bidding attempt to break the contention condition. Once a station gains control of the line, message transmission can start. (For a dial-up connection, see the Switched-Network Operation discussion in the Additional Data Link Capabilities section).

Polling and Selection

In a multipoint environment, the control station either polls or selects the tributary stations. Polling is an “invitation to send” transmitted from the control station to a specific tributary station. Selection is a “request to receive” notification from the control station to one of the tributary stations instructing it to receive the following message(s). These capabilities permit the control station to specify the transmitting station and to control the direction of transmission. Each station in the data link is assigned a unique station address, which is used to acquire the station’s attention during either polling or selection. Each station address can consist of from one to seven characters, depending on the specific station requirements. The first character addresses the station itself, while additional characters indicate the desired component of the station. Depending on the particular station, the station address may consist of the first two characters, where the first character is repeated for increased reliability. Once the station’s attention is acquired and it responds affirmatively, message transmission can start.

Message Blocks

The message consists of one or more blocks of text data. The text is transmitted in blocks to provide more accurate and efficient error control. The text data is the body of the message and is identified by a start of text (STX) character immediately preceding each block of text. In addition, each block of text except the last is immediately followed

*This does not imply full compatibility with other manufacturer’s synchronous devices using the USASCII code.

S/360 Main Storage Bit Positions 0, 1, 2, 3																	
Bit Positions 4, 5, 6, 7		0000	0001	0010	0011	0100	0101	0110	0111	1000	1001	1010	1011	1100	1101	1110	1111
	Hex	0	1	2	3	4	5	6	7	8	9	A	B	C	D	E	F
0000	0	NUL	DLE	DS		SP	&	-						{	}	\	0
0001	1	SOH	DC1	SOS						a	j	~		A	J		1
0010	2	STX	DC2	FS	SYN					b	k	s		B	K	S	2
0011	3	ETX	DC3							c	l	t		C	L	T	3
0100	4	PF	RES	BYP	PN					d	m	u		D	M	U	4
0101	5	HT	NL	LF	RS					e	n	v		E	N	V	5
0110	6	LC	BS	EOB ETB	UC					f	o	w		F	O	W	6
0111	7	DEL	IL	PRE ESC	EOT					g	p	x		G	P	X	7
1000	8		CAN							h	q	y		H	Q	Y	8
1001	9	RLF	EM						\	i	r	z		I	R	Z	9
1010	A	SMM	CC	SM		¢	!	!	:								
1011	B	VT				.	\$,	#								
1100	C	FF	IFS		DC4	<	*	%	@								
1101	D	CR	IGS	ENQ	NAK	()	_	'								
1110	E	SO	IRS	ACK		+	;	>	=								
1111	F	SI	IUS	BEL	SUB		¬	?	"								



Duplicate Assignment

Figure 2. EBCDIC Character Assignments (Part 1 of 2)

by an end of transmission block (ETB) character or an intermediate block (ITB) character. The last block of text in a message is immediately followed by an end of text (ETX) character.

The text of the message can be preceded by a heading that contains auxiliary information (e.g., station control, priority, etc.) pertaining to the following text data. The heading is identified by a start of heading (SOH) character immediately preceding it.

For greater reliability, a unique character should always follow SOH to identify the heading function. The reason for this is to preclude the possibility of heading data being interpreted as text data, or vice versa, due to transmission errors. This unique character should not be used following STX. The per cent (%) character should not be used for this purpose, as SOH% is presently used to identify request-for-test or station-dependent control messages.

As each message block is completed, it is checked for

Character	Hex	Character	Hex	Character	Hex
A	C1	␣	4A	RS	35
B	C2	!	5A	SI	0F
C	C3	:"	7A	SM	2A
D	C4	#	7B	SMM	0A
E	C5	,	6B	SO	0E
F	C6	.	4B	SOH	01
G	C7	>	4C	SOS	21
H	C8	*	5C	Space	40
I	C9	+	6C	STX	02
J	D1	%	7C	SUB	3F
K	D2	@	4D	SYN	32
L	D3	(5D	UC	36
M	D4)	6D	VT	0B
N	D5	-	7D		
O	D6	_	4E		
P	D7	+	5E		
Q	D8	;	6E		
R	D9	=	7E		
S	E2	>	4F		
T	E3	?	5F		
U	E4	?	6F		
V	E5	?	7F		
W	E6	?	C0		
X	E7	?	D0		
Y	E8	?	E0		
Z	E9	?	A1		
a	81	?	79		
b	82	?	6A		
c	83	?	2F		
d	84	?	16		
e	85	?	24		
f	86	?	18		
g	87	?	1A		
h	88	?	0D		
i	89	?	11		
j	91	?	12		
k	92	?	13		
l	93	?	3C		
m	94	?	07		
n	95	?	10		
o	96	?	20		
p	97	?	19		
q	98	?	2D		
r	99	?	26		
s	A2	?	37		
t	A3	?	27		
u	A4	?	26		
v	A5	?	03		
w	A6	?	0C		
x	A7	?	22		
y	A8	?	05		
z	A9	?	1C		
0	F0	?	1D		
1	F1	?	17		
2	F3	?	1E		
3	F3	?	1F		
4	F4	?	06		
5	F5	?	25		
6	F6	?	3D		
7	F7	?	15		
8	F8	?	00		
9	F9	?	04		
&	50	?	34		
-	60	?	27		
/	61	?	14		
.	5B	?	09		
		BEL			
		BS	16		
		BYP	24		
		CAN	18		
		CC	1A		
		CR	0D		
		DC1	11		
		DC2	12		
		DC3	13		
		DC4	3C		
		DEL	07		
		DLE	10		
		DS	20		
		EM	19		
		ENQ	2D		
		*EOB	26		
		EOT	37		
		*ESC	27		
		*ETB	26		
		ETX	03		
		FF	0C		
		FS	22		
		HT	05		
		IFS	1C		
		IGS	1D		
		IL	17		
		IRS	1E		
		IUS	1F		
		LC	06		
		LF	25		
		NAK	3D		
		NL	15		
		NUL	00		
		PF	04		
		PN	34		
		*PRE	27		
		RES	14		
		RLF	09		

*ETB and EOB have the same hex assignment. PRE and ESC have the same hex assignment.

Figure 2. EBCDIC Character Assignments (Part 2 of 2)

transmission accuracy at the receiver before the transmission continues. (When VRC is used, each character is checked as it is received.)

Error Checking

Each block of data transmitted is error-checked at the receiving station in one of several ways, depending on the code and the functions employed. These checking methods are vertical redundancy checking (VRC), which is odd-parity checking by character as the data is received, and either longitudinal-redundancy checking (LRC) or cyclic-

redundancy checking (CRC), which check the block after it is received. After each transmission, the receiving station normally replies with ACK 0 or ACK 1—data accepted, continue sending; or with NAK—data not accepted (e.g., a transmission error was detected), retransmit previous block. Retransmission of a block of data following an initial NAK is usually attempted at least three times. If the transmitting station receives no reply after sending a data block, or if the reply is garbled, the transmitting station can request a retransmission of the reply by sending an ENQ. When the transmitting station is through sending a message, it ends the transmission by sending an end of transmission (EOT) character. The specific BSC error-checking capabilities available are shown, by code set, in Figure 5.

VRC/LRC

VRC (vertical redundancy checking) is an odd-parity check performed on a per-character basis with the USASCII character set. It is not available with either the EBCDIC or Six-Bit Transcode character sets. The VRC odd-parity check is performed on each character, including the LRC character.

LRC is a longitudinal-redundancy check on the total data bits by message block. It is a basic form of CRC. An LRC character is accumulated at both the sending and receiving terminals during the transmission of a block. This accumulation is called the block-check character (BCC), and it is transmitted immediately following an ETB, ETX, or ITB character. The transmitted BCC is compared with the accumulated BCC character at the receiving station for an equal condition. An equal comparison indicates a good transmission of the previous block.

The LRC accumulation is reset by the first STX or SOH character received after a line turnaround. All characters received thereafter, including control characters, until the next line turnaround, are included in the accumulation. Only SYN characters are not accumulated. Following an ITB BCC, the accumulation resets and starts again with the next received STX or SOH character.

CRC-12/CRC-16

Cyclic redundancy checking (CRC) is a more powerful method of block checking than LRC. Two modes of CRC are employed with BSC. The first, CRC-12, is used for six-bit transmission codes; the second, CRC-16, is used for eight-bit transmission codes.

A cyclic redundancy check is a division performed by both the transmitting and receiving stations using the numeric binary value of the message as a dividend, which is divided by a constant. The quotient is discarded, and the remainder serves as the check character, which is then transmitted as the block check (BCC) character immediately following a checkpoint character (ITB, ETB, or ETX). The receiving station compares the transmitted remainder to its own computed remainder, and finds no error if they are equal.

Bit Positions 4, 5, 6, 7		S/360 Main Storage Bit Positions 0, 1, 2, 3															
		0000	0001	0010	0011	0100	0101	0110	0111	1000	1001	1010	1011	1100	1101	1110	1111
HEX		0	1	2	3	4	5	6	7	8	9	A	B	C	D	E	F
0000	0	NUL	DLE	SP	0	@	P	\	p								
0001	1	SOH	DC1	!	1	A	Q	a	q								
0010	2	STX	DC2	"	2	B	R	b	r								
0011	3	ETX	DC3	#	3	C	S	c	s								
0100	4	EOT	DC4	\$	4	D	T	d	t								
0101	5	ENQ	NAK	%	5	E	U	e	u								
0110	6	ACK	SYN	&	6	F	V	f	v								
0111	7	BEL	ETB	'	7	G	W	g	w								
1000	8	BS	CAN	(8	H	X	h	x								
1001	9	HT	EM)	9	I	Y	i	y								
1010	A	LF	SUB	*	:	J	Z	j	z								
1011	B	VT	ESC	+	;	K	[k	}								
1100	C	FF	FS	,	<	L	\	l									
1101	D	CR	GS	-	=	M]	m	}								
1110	E	SO	RS	.	>	N	^	n	~								
1111	F	SI	US	/	?	O	_	o	DEL								

Figure 3. USASCII Character Assignments (Part 1 of 2)

The BCC accumulation consists of two bytes (e.g., 16 bits for CRC-16) when it is transmitted on the line, but functionally is one sequence.

EOT/NAK Pad Format Check

All BSC stations use the EOT/NAK pad format check to reduce the probability of a transmission line error converting an affirmative response (DLE sequence) into an EOT or NAK character. EOT and NAK must be followed

by a trailing pad character of all "1" bits. Although all eight bits of the trailing pad character may be sent, the receiver should check only the first four bit positions. A station receiving an EOT or NAK within the text or heading of a transmission block (following STX or SOH) will treat the character as data and continue to receive or monitor the transmission (timeout, recognition of a turnaround character, etc.).

Similar pad format checking on DLE sequences and ENQ may be done on an optional basis.

Character	Hex
A	41
B	42
C	43
D	44
E	45
F	46
G	47
H	48
I	49
J	4A
K	4B
L	4C
M	4D
N	4E
O	4F
P	50
Q	51
R	52
S	53
T	54
U	55
V	56
X	58
Y	59
Z	5A
a	61
b	62
c	63
d	64
e	65
f	66
g	67
h	68
i	69
k	6A
l	6B
m	6C
n	6E
o	6F
p	70
q	71
r	72
s	73
t	74
u	75
v	76
w	77
x	78
y	79
z	7A
0	30
1	31
2	32
3	33

Character	Hex
4	34
5	35
6	36
7	37
8	38
9	39
Space	20
!	21
"	22
#	23
\$	24
%	25
&	26
'	27
(28
)	29
*	2A
+	2B
,	2C
-	2D
.	2E
/	2F
:	3A
;	3B
<	3C
=	3D
>	3E
?	3F
@	40
[5B
\	5C
]	5D
^	5E
_	5F
`	60
{	7B
	7C
}	7D
~	7E
BEL	07
BS	08
CAN	18
CR	0D
DC1	11
DC2	12
DC3	13
DC4	14
DEL	7F
DLE	10
EM	19
ENQ	05
EOT	04
ESC	1B
ETB	17
ETX	03

Character	Hex
FF	0C
FS	1C
GS	1D
HT	09
LF	0A
NAK	15
NUL	00
RS	1E
SI	0F
SO	0E
SOH	01
STX	02
SUB	1A
SYN	16
US	1F
VT	0B

Character	Hex
A	01
B	02
C	03
D	04
E	05
F	06
G	07
H	08
I	09
J	11
K	12
L	13
M	14
N	15
O	16
P	17
Q	18
R	19
S	22
T	23
U	24
V	25
W	26
X	27
Y	28
Z	29
0	30
1	31
2	32
3	33
4	34
5	35
6	36
7	37
8	38
9	39
Space	1A
.	0B
,	2B
;	1B
#	3B
<	0C
*	1C
/	21
%	2C
@	3C
-	20
&	10
BEL	0D
DEL	3F
DLE	1F
EM	3E
ENQ	2D
EOT	1E
ESC	2A
ETB	0F
ETX	2E
HT	2F
NAK	3D
SOH	00
STX	0A
SUB	0E
SYN	3A
US	1D

Bit Positions 4, 5, 6, 7	S/360 Main Storage Bit Positions 0, 1, 2, 3			
	0000	0001	0010	0011
Hex	0	1	2	3
0000	0	SOH	&	-
0001	1	A	J	/
0010	2	B	K	S
0011	3	C	L	T
0100	4	D	M	U
0101	5	E	N	V
0110	6	F	O	W
0111	7	G	P	X
1000	8	H	Q	Y
1001	9	I	R	Z
1010	A	STX	SPACE	ESC
1011	B	.	S	,
1100	C	<	*	%
1101	D	BEL	US	ENQ
1110	E	SUB	EOT	ETX
1111	F	ETB	DLE	HT

Figure 3. USASCII Character Assignments (Part 2 of 2)

Figure 4. Six-Bit Transcode Character Assignments

Data-Link Control

Control of the data-link is maintained through the use of these control characters and sequences:

- SYN—Synchronous Idle
- SOH—Start of Heading
- STX—Start of Text
- ITB—End of Intermediate Transmission Block
- ETB—End of Transmission Block
- ETX—End of Text
- EOT—End of Transmission
- ENQ—Enquiry
- ACK 0/ACK 1—Alternating Affirmative Acknowledgments
- WACK—Wait-Before-Transmit Positive Acknowledgment
- NAK—Negative Acknowledgment

- DLE—Data-Link Escape
- RVI—Reverse Interrupt
- TTD—Temporary Text Delay
- DLE EOT—Disconnect Sequence for a Switched Line

Several variations in the designations and compositions of the data-link control characters and sequences exist among the various code sets. For example, ACK 0 and ACK 1 are two-character sequences having DLE as the first character. These and other variations are shown in Figure 6. Characters that remain the same in all code sets are designated by nc (no change).

Transmission Code	Type of Checking		
	No Transparency	Transparency Installed and Operating	Transparency Installed But Not Operating
EBCDIC USASCII SBT	CRC-16 VRC/LRC CRC-12	CRC-16 CRC-16 CRC-12	CRC-16 VRC/CRC-16 CRC-12

Figure 5. Error Checking Capabilities

Data Link Character	Code Chart Sequence		
	EBCDIC	USASCII	Six-Bit Transcode
SYN	nc	nc	nc
SOH	nc	nc	nc
STX	nc	nc	nc
ETB	EOB(ETB)	nc	nc
ETX	nc	nc	nc
EOT	nc	nc	nc
ENQ	nc	nc	nc
ACK 0	DLE '70'	DLE 0	DLE -
ACK 1	DLE /	DLE 1	DLE T
NAK	nc	nc	nc
DLE	nc	nc	nc
ITB	IUS	US	US
WACK	DLE ,	DLE ;	DLE W
RVI	DLE @	DLE <	DLE 2
TTD	STX ENQ	STX ENQ	STX ENQ

nc--no change
' '---Indicates the hexadecimal representation (no graphic assignment).

Figure 6. Character Conversion Chart

SYN--Synchronous Idle

This character is used to establish and maintain synchronization and as a time fill in the absence of any data or other control character. Two contiguous SYN's at the start of each transmission (SYN SYN) are referred to as the character-phase sync pattern (represented by Ø in Figures and format examples).

SOH--Start of Heading

This character precedes a block of heading characters. A heading consists of auxiliary information (such as routing and priority) necessary for the system to process the text portion of the message.

STX--Start of Text

This character precedes a block of text characters. Text is that portion of a message treated as an entity to be transmitted through to the ultimate destination without change. STX also terminates a heading.

ETB--End of Transmission Block

The ETB character indicates the end of a block of characters started with SOH or STX. The blocking structure is not necessarily related to the processing format. The block-check character is sent immediately following ETB. ETB requires a reply indicating the receiving station's status (ACK 0, ACK 1, NAK, or, optionally, WACK or RVI).

ITB--End of Intermediate Transmission Block

The ITB character (IUS in the EBCDIC charts and US in the USASCII and Six-Bit Transcode charts--interchange unit separator) is used to divide a message (heading or text) for error checking purposes without causing a reversal of transmission direction. The block-check character immediately follows ITB and resets the block-check count. After the first intermediate block, successive intermediate blocks need not be preceded by STX or SOH. (For transparent data, each successive intermediate block must begin with DLE STX.) If one intermediate block is heading and the next intermediate block is text, STX must begin the text block.

Normal line turnaround occurs after the last intermediate block, which is terminated by ETB or ETX (DLE ETB or DLE ETX for transparency). When one of these ending characters is received, the receiving station responds to the entire transmission. If a block-check error is detected for any of the intermediate blocks, a negative reply is sent, which requires retransmission of all intermediate blocks.

All BSC stations must have the ability to receive ITB and its attendant BCC. The ability to transmit the ITB character is a station option.

Note: For some stations, ITB's in transparent data are permitted only at predetermined, fixed intervals within the transparent text. The receiver must be aware of the interval length.

ETX--End of Text

The ETX character terminates a block of characters started with STX or SOH and transmitted as an entity. The block-check character is sent immediately following ETX. ETX requires a reply indicating the receiving station's status.

EOT--End of Transmission

This character indicates the end of a message transmission, which may contain one or more blocks, including text and associated headings. It causes a reset of all stations on the line. EOT is also used as:

1. A response to a poll when the polled station has nothing to transmit.
2. An abort signal to indicate a system malfunction or operational situation that precludes continuation of the message transmission.

ENQ—Enquiry

The ENQ character is used to obtain a repeat transmission of the response to a message block if the original response was garbled or was not received when expected. ENQ is also used to bid for the line when using a point-to-point line connection. It also indicates the end of a poll or selection sequence.

ACK 0/ACK 1—Affirmative Acknowledgment

These replies, in proper sequence, indicate that the previous block was accepted without error and the receiver is ready to accept the next block of the transmission. ACK 0 is the positive response to selection (multipoint) or line bid (point-to-point).

WACK—Wait-Before-Transmit Positive Acknowledgment

WACK allows a receiving station to indicate a “temporarily not ready to receive” condition to the transmitting station. It can be sent as a response to a text or heading block, selection sequence (multipoint), line bid (point-to-point with contention) or an ID (identification) line bid sequence (switched network). WACK is a positive acknowledgment to the received data block or to selection.

The normal transmitting station response to WACK is ENQ, but EOT and DLE EOT are also valid responses. When ENQ is received, the receiving station will continue to respond with WACK until it is ready to continue. See the Continue Timeout discussion under Timeouts in the Message Formats for Basic Operation section for further explanation. An example of how WACK is used is shown in Figure 7. The ability to receive WACK is mandatory for all BSC stations, but the capability to send WACK is optional.

NAK—Negative Acknowledgment

NAK indicates that the previous block was received in error and the receiver is ready to accept a retransmission of the erroneous block. It is also the “not ready” reply to station selection or line bid.

DLE—Data Link Escape

DLE is a control character used exclusively to provide supplementary line control characters, such as WACK, ACK 0, ACK 1, RVI, and transparent mode control characters. The sequences DLE STX, DLE ETX, DLE ITB, and DLE ETB initiate and terminate transparent text. In addition, other DLE control sequences (DLE ENQ, DLE DLE,

DLE EOT) are used to provide active control characters within transparent text as required. For additional information, see the Transparent-Text Mode discussion in the Additional Data Link Capabilities section.

RVI—Reverse Interrupt

The RVI control sequence is a positive response used in place of the ACK 0 or ACK 1 positive acknowledgment. RVI is transmitted by a receiving station to request termination of the current transmission because of a high priority message which it must transmit to the sending station, or in case of a multipoint environment, the control station, acting as a receiver, now wishes to communicate with another station on the line. Successive RVI's cannot be transmitted, except in response to ENQ.

The sending station treats the RVI as a positive acknowledgment, and responds by transmitting all data that prevents it from becoming a receiving station. More than one block transmission may be required to empty the sending station's buffers.

The character structure of the RVI control sequence is as follows:

EBCDIC	DLE@
USASCII	DLE <
Six-Bit Transcode	DLE2

The ability to receive RVI is mandatory for all BSC stations, but the ability to transmit RVI is optional. Figure 7 illustrates the use of RVI.

TTD—Temporary Text Delay

The TTD control sequence is sent by a sending station in message transfer state when it wishes to retain the line but is not ready to transmit. The TTD control sequence (STX ENQ) is normally sent after approximately two seconds if the sending station is not capable of transmitting the next text block or initial text block within that time. This two-second timeout avoids the nominal three-second receive timeout at the receiving station (Figure 7).

The receiving station responds NAK to the TTD sequence, and waits for transmission to begin. If the sending station is still not ready to transmit, the TTD sequence can be repeated one or more times.

This delay in transmission can occur when the sending station's input device has not completely filled the buffer due to inherent machine timings. TTD is also transmitted by a sending station in message transfer mode to indicate to the receiver that it is aborting the current transmission (Figure 7). After receiving NAK to this TTD sequence, the sending station sends EOT, resetting the stations to control mode (forward abort).

WACK (Point-to-Point)

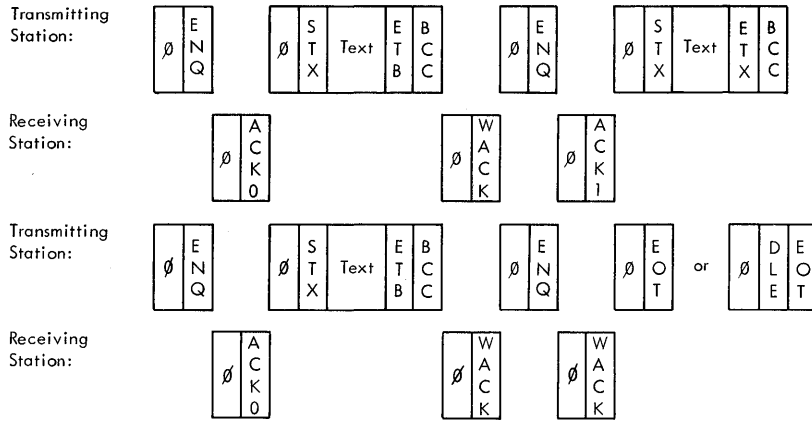

RVI (Point-to-Point)

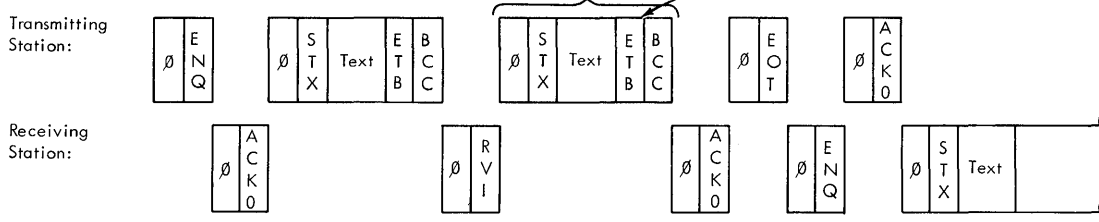

TTD

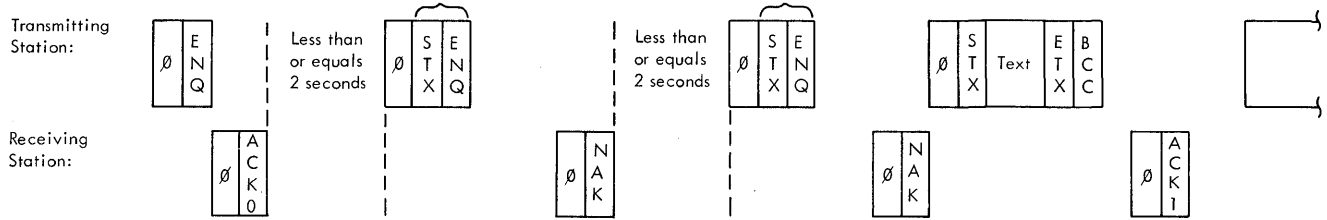

Forward Abort Sequence

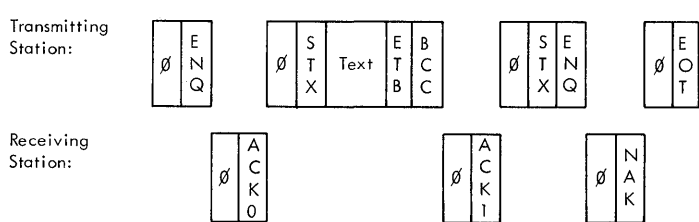

Note: \emptyset = SYN Characters

Figure 7. Use of WACK, RVI, and TTD

DLE EOT—Disconnect Sequence for a Switched Line

Transmission of DLE EOT on a switched line indicates to the receiver that the transmitter is going “on-hook.” Either the calling or the called station may transmit this disconnect sequence. DLE EOT is normally transmitted when all message exchanges are complete, and may optionally be transmitted at any time instead of EOT to cause a disconnect.

Alternating Affirmative Acknowledgments

The BSC procedures specify the alternate use of ACK 0 and ACK 1 as affirmative replies. The use of ACK 0 and ACK 1 provides a sequential checking control for a series of replies. (See Figure 16 for an example of the use of ACK 0 and ACK 1.) Thus it is possible to maintain a running check to ensure that each reply corresponds to the immediately preceding message block. ACK 0 is always used as the affirmative reply to selection or line bid.

Proper formatting of BSC messages requires use of the specifically-defined data-link control characters. Specific formatting rules are provided for heading and text data for both point-to-point and multipoint operations. Basic BSC operation is either point-to-point with contention or centralized multipoint. Switched-network operation is discussed in the Additional Data Link Capabilities section.

HEADINGS

The heading is a block of data starting with SOH and containing one or more characters that may be used for message control (e.g., message identification, routing, and priority). SOH initiates the block-check-character (BCC) accumulation. (An initial SOH is not included in the accumulation.) A block of heading data may be of fixed or variable length, depending on the specific terminals and applications. The heading is terminated by STX.

Only the first SOH or STX in a transmission block following a line turnaround causes the BCC to reset. All succeeding STX or SOH characters (until a line turnaround) are included in the BCC. This permits the entire transmission (excluding the first SOH or STX) to be block-checked as shown in Figure 8.

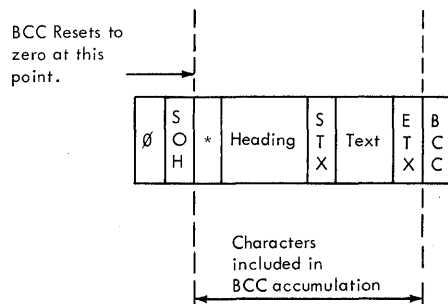

* Unique character (optional)

Figure 8. Block Check Character Accumulation—Entire Transmission

If block checking is desired for the heading alone, the heading can be ended with ETB. This is followed by the BCC and appears as shown in Figure 9.

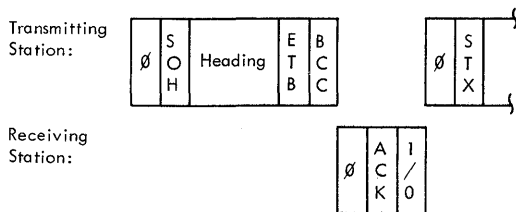

Figure 9. Block Check Character Accumulation—Heading Only

The heading can be terminated prematurely by use of the ENQ (indicating “disregard this block”). The use of this character is shown in Figure 10.

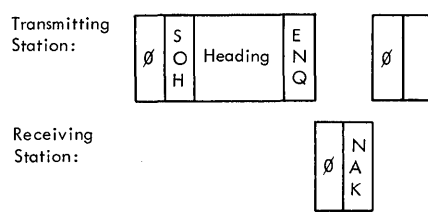

Figure 10. Use of ENQ to Terminate Heading

Note: The negative reply is required here since the heading ended with a forced error condition. Transmission should continue following this sequence and will normally be a retransmission of the same block.

TEXT

The text data is the *most significant* portion of the transmission. It is transmitted in complete units called messages, which are initiated by STX and concluded with ETX. Each message is a complete unit that can stand alone and is not necessarily directly related to other messages being transmitted. A message can be subdivided into smaller blocks for ease in processing and more efficient error control. Each block starts with STX and ends with ETB (except for the last block of a message, which ends with ETX). A single transmission can contain any number of blocks (ending with ETB) or messages (ending with ETX). An EOT following the last ETX block indicates a normal end of transmission. Message blocking without line turnaround can be accomplished by using ITB (see the Additional Data Link Capabilities section).

Control characters or sequences within a block of text are not allowed. Any station receiving a control character within a text block treats the control character or sequence as data and waits for the block check character (BCC) to detect a possible error. If an error is detected, normal recovery procedures are used. If no error is detected, the transmission is treated as valid data.

The following figures are examples of various forms of block transmission for text data; Figure 11 shows the last text block of a message, and Figure 12 shows the format for other text blocks.

A block of text data can be terminated prematurely by using an ENQ character, which signals the receiver to “disregard this block.” NAK is always the reply in this situation, since the block ended with a forced error condition. An example is shown in Figure 13.

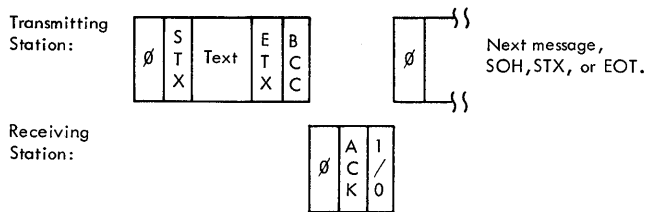

Figure 11. Format of Last Test Block

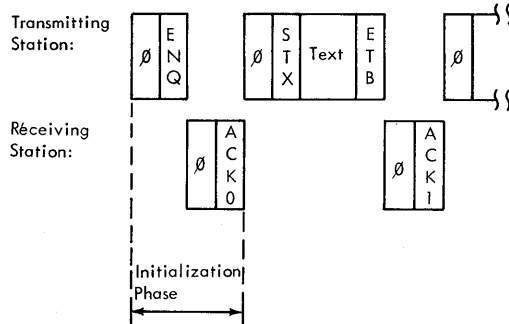

Figure 14. Complete Initialization Phase

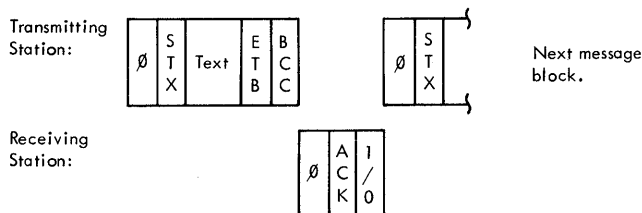

Figure 12. Format of Normal Test Block

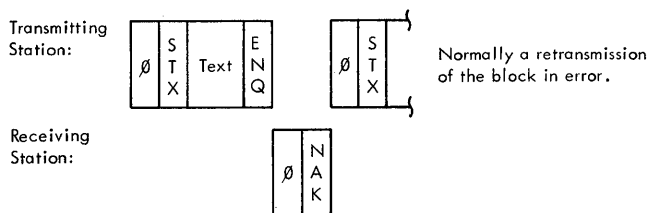

Figure 13. Format of Block Ended with Forced Error Condition

POINT-TO-POINT OPERATION (WITH CONTENTION)

This type of operation is available for either privately owned lines or leased private lines. When transmission is started, an initialization sequence (consisting of \emptyset ENQ) must be instituted by the station attempting to acquire the line. A station receiving this sequence (and ready for message reception) replies with \emptyset ACK 0. If the station is not ready to receive, it replies with either of the following:

- \emptyset NAK (Negative Acknowledge)
- \emptyset WACK (Wait Before Transmit Positive Acknowledge).

The format for the complete initialization phase, including the start of the actual message transmission, is shown in Figure 14.

To avoid the problems associated with simultaneous transmission requests, each station is assigned a priority—primary or secondary. The higher-priority (primary) station sends an ENQ to acquire the idle line; it will continue to do so until it receives an affirmative response or until the retry limits of the primary station are reached. If the primary station receives an ENQ and it has not initiated a request for the line, then it replies with ACK 0 (if ready to receive), WACK, or NAK. Thus the secondary station can gain control of the line for a transmission only when the line is left free by the primary station.

Message transmission is ended and the line is returned to an idle state by the transmission of EOT. The station sending EOT will not send an initialization sequence before three seconds have elapsed, thus allowing the other station to bid for the line.

MULTIPOINT OPERATION (CENTRALIZED)

In multipoint operation, one station in the data link is designated as the control station, and the remaining stations are designated as tributary stations. All transmissions for this type of operation are regulated by the control station by means of polling and selection. By sequentially polling each tributary station, the control station directs the incoming message traffic. The outgoing traffic is regulated from the control station by selection of the desired tributary station to receive the message. All transactions are between the control station and the selected tributary station.

The initialization phase for multipoint operation is accomplished by the control station transmitting the following sequence:

∅ EOT PAD ∅ (Polling or selection address) ENQ

This sequence ensures that all monitoring tributary stations are now in control mode and thus prepared to receive either a poll or a selection from the control station. The polling or selection sequence transmitted while in control mode designates the station that is to transmit or receive data. This sequence can also define the specific device required if the station has several available. An example of the complete sequence transmitted from the control station shown in Figure 15. Refer to the Additional Format Considerations discussion for a description of pad characters.

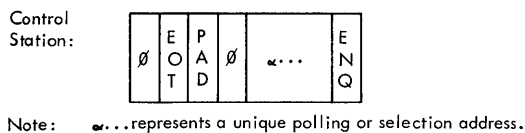

Figure 15. Multipoint Initialization Sequence

The polling and selection sequences, consisting of from one to seven characters, are followed by ENQ. For specific sequences, refer to the appropriate component description manual.

The possible replies from a polled tributary station are:

- Heading data—
∅ SOH . . .
- Text data—
∅ STX text . . .
- Transparent text data—
∅ DLE STX transparent text . . .
- Negative reply when the station has nothing to send—
∅ EOT
- Temporary text delay when the station is unable to transmit its initial block within two seconds—
∅ STX ENQ

The possible replies from a selected tributary station are:

- Affirmative reply indicating that the tributary station is prepared to receive—
∅ ACK 0
- Negative reply indicating that the tributary station is not ready to receive—
∅ NAK
- Reply indicating that the tributary station is temporarily not ready to receive (busy)—
∅ WACK

The complete formatting of message traffic for a multipoint operation is shown in Figure 16, which illustrates both the polling and the selection of two different tributary stations by the control station. The station identification for the two different operations is indicated by using uppercase alphabetic characters for polling and lowercase alphabetic characters for selection (for this example). The component designations are: 1 for printer and 6 for reader.

ADDITIONAL FORMAT CONSIDERATIONS

The sync pattern and pad character are an integral part of block and control-sequence formats in BSC operation. The sync pattern ensures that all active stations in the data link operate in step. The pad character ensures full transmission and reception of the first and last significant character of each transmission. Neither pad nor sync characters are reflected in the received message; however, both must be properly provided for in the original message format before transmission.

Sync Patterns

Transmission over the data link is serial-by-bit, serial-by-character, with synchronization of the transmitted data established by transmission of an appropriate sync pattern. This pattern must be sent at the start of each transmission to ensure that the receiving stations are in step with the sending station. Synchronization of all transmitted data is established at bit and character level through use of this sync pattern. Each bit received must be in the proper time relationship so that it can be correctly identified (sampled). Also, each series of bits must be assembled in the correct relationship to ensure assembly of the proper bits to create the originally-transmitted character.

The sync pattern always precedes a transmission and is used to establish bit and character synchronization between transmitter and receiver. The pattern may be different depending on the requirement for bit synchronizing. The character-phase pattern is unnecessary when operating with self-clocked data sets.

Character Phase

The synchronizing pattern for establishing character phase consists of at least two contiguous SYN characters. If more than two are sent, the sync pattern ends with the last transmitted SYN.

Character phase must be re-established for each transmission. This is accomplished by the receiving station

Polling

Control:

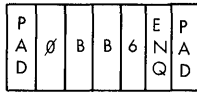
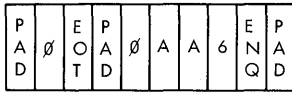

Tributary A:

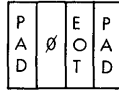

Tributary B:

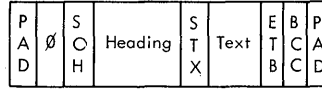

Control:
(Continued)

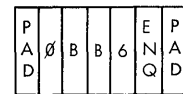
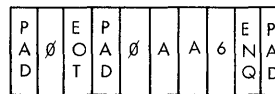
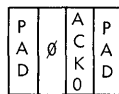
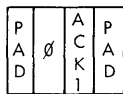

Tributary A:
(Continued)

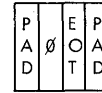

Tributary B:
(Continued)

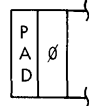
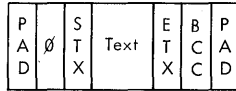

Selection

Control:

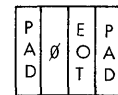
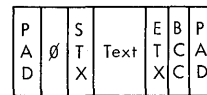
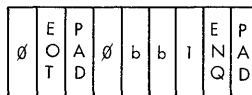
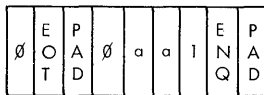

Tributary A:



Tributary B:

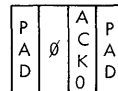

Note: ∅ represents SYN characters

Figure 16. Typical Data Link Message Traffic (Centralized Multipoint Operation)

recognizing at least two contiguous SYN characters in the bit stream. Character phase remains established at the receiving station until either (1) a line turnaround character or the end-of-transmission character is received, or (2) a timeout is complete.

Bit Phase

Bit phase must be established before the character phase pattern is received or the receiving station will not recognize the transmission. The transmitter does not know if the receiver failed to establish phase until it fails to receive a reply to the transmission. In cases where the data set is self-clocked, bit phase is automatically established by the data set; only the character-phase pattern has to be transmitted by the BSC station equipment.

When clocking is performed by a business machine clock (internal clock), a special bit-phase sync pattern must precede the character-phase sequence. The bit synchronizing required for business machine clocks is two consecutive hexadecimal '55' characters.

Note: The hex '55' '55' or SYN SYN SYN SYN pattern provides the 16 transitions necessary for bit synchronization. Some earlier machines may use four consecutive SYN's. The hex '55' '55' synchronization pattern is preferred, but either pattern is acceptable.

Message Sync

To provide and monitor for the maintenance of the in-step condition during transmission of the entire message, additional sync-patterns are inserted in the message by the transmitter. The sync-idle sequence is automatically inserted in heading and text data at one-second intervals. For normal data SYN SYN is inserted, while for transparent data DLE SYN is inserted at these time intervals. This technique permits receiving stations to verify that they are in step. During the transmission of normal data, insertion of SYN SYN permits a station that is out of step to re-establish character phase. DLE SYN cannot establish phase. Sync-idle characters are not included in the BCC accumulation, and are stripped from the message at the receiving station.

Pad Characters

To ensure that the first and last characters of a transmission are properly transmitted by the data set, all BSC stations add a pad character before and after each transmission. The one-character pad (leading pad) preceding each initial synchronizing pattern ensures that the station will not start sending its synchronizing pattern before the other station is prepared to receive. The leading pad character may consist of alternating '0' and '1' bits (hex '55') or a SYN character.

A pad character (trailing pad) is also added following each transmission (e.g., NAK, EOT, ENQ). Since ETB or ETX causes line turnaround, the pad character follows the BCC. The trailing pad character ensures that the last significant character (e.g., ETB BCC, ETX BCC, or NAK) is sent before the data set transmitter turns off. The trailing pad character consists of all '1' bits (hex 'FF').

TIMEOUTS

Timeouts are used to prevent indefinite data-link tie-ups, due to false sequences or missed turnaround signals, by providing a fixed time within which any particular operation must occur. Due to the different requirements for the various operations, four specific timeout functions are provided: transmit, receive, disconnect, and continue.

Transmit Timeout

This is a nominal one-second timeout that establishes the rate at which sync idles are automatically inserted into transmitted heading and text data. In normal data, two consecutive sync-idle characters (SYN SYN) are inserted every second, while for transparent data, one transparent sync-idle sequence (DLE SYN) is inserted every second. If business machine clocking is used, DLE SYN insertion is required at least every 84 characters to insure maintenance of bit synchronization in the event of transitionless data. There must be at least 54 characters between each DLE SYN. Sync idles are inserted in the message for timing purposes only, and have no effect on the message format. If SYN characters are transmitted for a period of greater than 3 seconds, the Write command will timeout.

Receive Timeout

This is a nominal three-second timeout, and is used as follows:

- a. Limits the waiting time tolerated for a transmitting station to receive a reply.
- b. Permits any receiving or monitoring station to check the line for sync-idle signals. These sync idles indicate that the transmission is continuing; thus this timeout is reset and restarted each time a sync idle is detected.
- c. Limits the time any tributary station in a multipoint network will remain in control mode while monitoring the line for its address code. This timeout runs whenever the station is in control mode. It is reset and restarted each time an end signal (EOT, ENQ, NAK, WACK, ACK) is recognized, as long as the station remains in control mode.

Disconnect Timeout

This timeout is used optionally on switched network data links. It is a nominal 20-second timeout used to prevent a station holding a connection for prolonged periods of inactivity. After 20 seconds of inactivity, the station will disconnect from the switched network.

Continue Timeout

This is a nominal two-second timeout associated with the transmission of TTD and WACK. The continue timeout is used by stations where the speed of input devices (for transmitting stations) or output devices (for receiving

stations) affect buffer availability and may cause transmission delays.

TTD is sent by the transmitting station up to two seconds after receiving acknowledgment of the previous block if the transmitting station is not capable of sending the next transmission block before that time.

A receiving station must transmit WACK to indicate a "temporarily not ready to receive" condition if it is not able to receive within the two-second timeout. The purpose of the timeout intervals is to permit the receiving station to send an appropriate affirmative reply immediately if it becomes appropriate within the interval.

These additional capabilities are available as options on some stations to further increase the flexibility of the data link. They include transparent-text mode, limited conversational mode, and leading graphics transmission.

TRANSPARENT-TEXT MODE

This mode permits greater versatility in the range of coded data that can be transmitted. This is because all data, including the normally restricted data-link line-control characters, are treated only as specific “bit patterns” when transmitted in transparent mode. Thus, unrestricted coding of data is permitted for transparent-mode operation. This is particularly useful for transmitting binary data, floating point numbers, packed-decimal data, unique specialized codes, or machine-language computer programs. All data link control characters can be transmitted as transparent data without taking on control meaning.

Any data-link control characters transmitted during transparent mode must be preceded by a DLE to be recognized as a control function. Thus the following sequences are effective during transparent-mode operation:

<i>Sequence</i>	<i>Use</i>
DLE STX	Initiates the transparent mode for the following text.
DLE ETB	Terminates a block of transparent text, returns the data link to normal mode, and calls for a reply.
DLE ETX	Terminates the transparent text, returns the data link to normal mode, and calls for a reply.
DLE SYN	Used to maintain sync or as time-fill sequence for transparent mode.
DLE ENQ	Indicates “disregard this block of transparent data” and returns the data link to normal mode.
DLE DLE	Used to permit transmission of DLE as data when a bit pattern equivalent to DLE appears within the transparent data. One DLE is disregarded; the other is treated as data.
DLE ITB	Terminates an intermediate block of transparent data, returns the data link to normal mode, and does not call for a reply. The block check character follows DLE ITB. Transparent intermediate blocks may have a particular fixed length for a given system. If the next intermediate block is transparent, it must start with DLE STX.

The DLE STX following an intermediate transparent block may be preceded by SYN SYN, to permit any station out of sync to correctly synchronize with the transmission.

All replies, enquiries, and headers are transmitted in normal mode. Transparent data is received on a character-by-character basis; thus character phase is maintained in the usual manner.

An example of a block of transparent data is shown in Figure 17.

The boundaries of transparent data are determined by the DLE STX and the DLE ITB, DLE ETB, or DLE ETX sequences, which initiate and terminate the transparent mode. Thus, the length of a transparent message can vary with each transmission.

For checking the transmitted transparent data, CRC-16 is available. Refer to Error Checking for the available options. If the system has VRC in normal mode, this is suppressed within transparent-text blocks. This permits using the parity bit as an additional data-bit position for each character transmitted as transparent data.

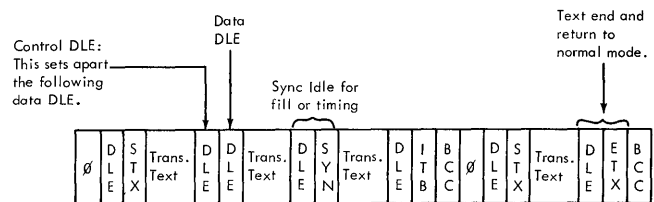

Figure 17. Transparent Data Block

LIMITED CONVERSATIONAL MODE

This mode provides for transmitting heading or text data in reply to a complete message. A conversational reply can be sent only in place of an affirmative reply to a block of text that ended with ETX or DLE ETX. Conversational replies are not permitted following a block of heading or blocks of text that ended with ETB.

Either SOH or STX can start a conversational reply. The station receiving the conversational reply will interpret the SOH or STX as the affirmative reply to the last data block it transmitted. Transparent text (beginning with DLE STX) can also be used as a conversational reply. A station receiving a conversational reply is not permitted to transmit another conversational reply in response. An example of limited conversational mode is shown in Figure 18.

SWITCHED-NETWORK (DIAL-UP) OPERATION

When operating in a switched network, the point-to-point connection can be established by either manual or auto-

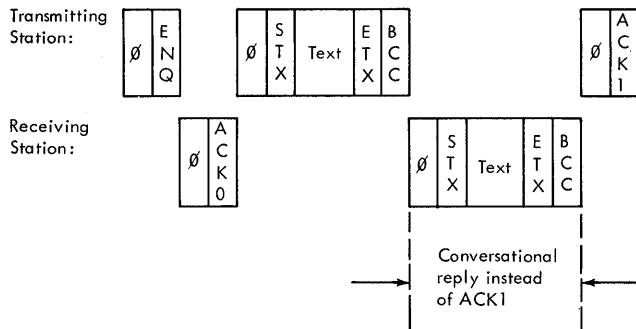

Figure 18. Limited Conversational Mode

matic means. Dialed connections are operated as point-to-point lines with contention. Both stations start in "circuit-assurance mode." Once circuit assurance is established and identification (optional) is completed, the stations use the normal BSC procedures required for operation (switched point-to-point). When both stations have completed their message transmissions, a disconnect signal is normally sent.

The "circuit-assurance mode" is entered when the called station goes "off-hook." At this time the calling station is notified by a signal from its data set that a connection with another data set has been established. Once this indication is received, the calling station sends either of the following messages:

WRU—who are you (the transmitted sequence is: Ø ENQ). This requests the called terminal to identify itself.

I AM/WRU—(the transmitted sequence is Ø α . . . ENQ). α indicates the graphics permitted for station identification and supplementary control purposes. This message identifies the calling station and requests the called station to identify itself.

Either message is then followed by an identification message from the called station:

ID ACK 0—(the transmitted sequence is: Ø α . . . ACK 0, where ID is optional).

Note: If the received ID is unsatisfactory, then either station can initiate a disconnect sequence.

Additional signals available as a reply to the WRU or the I AM/WRU message are:

NAK—This indicates that a "not ready" condition exists at the called station.

WACK—(optional) This indicates that "temporary not ready to continue" condition exists at the called station.

All BSC stations must provide the capability (optional usage) to transmit identification sequences in order to permit several types of BSC stations to operate on the same switched line. An ID sequence can be from 2 to 15 characters long. The minimum two-character sequence consists of the same character transmitted twice.

ID sequences may precede ENQ, ACK 0, and NAK in control mode. A receiving station must be able to recognize the above control characters when preceded by an ID sequence. WACK must not be preceded by an ID sequence. Station specifications must be consulted to determine the ability of the station to recognize an ID sequence as identification or to attach any functional significance to it.

Both stations exit from circuit-assurance mode following satisfactory initialization when any of the following sequences are sent or received:

Ø EOT—returns the data link to normal operation, control mode.

Ø SOH—initiates a block of header data.

Ø STX—initiates a block of text data.

Ø DLE STX—initiates a block of transparent-text data (when used).

All signals other than those just described are considered to be errors. If a valid reply is not received by the calling station (following either a WRU or an I AM/WRU) within the receive timeout period, the request message can be retransmitted. However, the data link continues in circuit-assurance mode until the circuit assurance sequence is satisfactorily completed.

The call between stations can be terminated by the disconnect timeout or by transmission of the disconnect sequence:

Ø DLE EOT

This sequence may be initiated by either station when operating on a switched-network basis. When operating with a control station, the control station normally initiates the disconnect sequence. As this sequence is transmitted and received, each station returns to an "on-hook" condition and the line is dropped.

LEADING GRAPHICS

All BSC stations must be able to receive from one to seven characters preceding an ACK 0, ACK 1, or NAK sent as a response to a text block. A receiving station must be capable of recognizing control sequences regardless of the presence of leading graphics. Station specifications determine whether the station will attach any functional significance to these characters or will have the ability to transmit them.

Several additional considerations must be made when planning for BSC. The items listed below pertain to certain specific parts of the communications area; for any given situation, usually only one of these items will apply.

PLANNING FOR A MULTIPOINT DATA COMMUNICATIONS NETWORK

When planning a multipoint network, using common-carrier-provided facilities, any configuration having more than ten stations per line requires advance consultation with a representative of the local common carrier during the initial planning stages. This is necessary to ensure adequate lead time for the additional common-carrier engineering and planning that may be required in providing the specific communications network desired.

COMMUNICATIONS OVER SWITCHED (DIAL-UP) FACILITIES

For switched-network operation, procedures should be provided to permit the connection to be broken and re-established (by hanging up and redialing the number) whenever transmission difficulties are experienced. This procedure provides the opportunity for establishing a totally different communications path, which may have improved transmission capabilities, when the connection is re-established.

COMMUNICATIONS OVER VOICE-GRADE LINES

BSC can operate with Western Electric Data Sets 201 over any of the following voice-grade communications facilities:

1. Common-carrier switched telephone network using Western Electric Data Set 201A3, which operates at 2000 bits per second (bps).
2. Common-carrier Type 3002 Channels with C2 conditioning using Western Electric Data Set 201A3, which operates at 2000 bps in a multipoint or point-to-point configuration.
3. Common-carrier Type 3002 Channels with C2 conditioning using Western Electric Data Set 201B3, which operates at 2400 bps in a point-to-point or multipoint configuration.
4. Common-carrier Type 3002 Channels with C4 conditioning using Western Electric Data Set 201B3, which operates at 2400 bps in a point-to-point or a multipoint configuration that does not exceed four points.

C4 conditioning can be provided only between one designated point (A) and up to three remote points (B, C, D). Conditioning then cannot be provided between the three remote points; the communications facility between these three points is undefined and may be so poor as to prevent communications. (See Figure 19.) C4 conditioning may be provided for A-B, A-C, and A-D. The facility is undefined between B-C, B-D, and C-D.

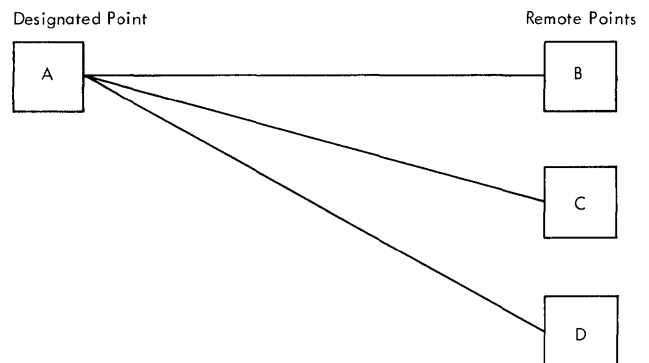

Figure 19. Channels with C4 Conditioning

There is no code sensitivity or degradation in the predictable error rate when transmitting data over facilities 1, 2, or 4. Likewise, there is no degradation when transmitting in the EBCDIC or USASCII format over any of the four voice-grade facilities. An increase in the error rate may be experienced when transmitting code-independent (transparent) data over common-carrier Type 3002 Channels with C2 conditioning with Western Electric Data Set 201B3 (facility 3). See the discussion of Situation below.

Equivalent data sets and modems can be substituted for any of the above facilities.

Systems transmitting transparent data should use one of the code-insensitive facilities listed (1, 2, or 4). The user may choose to employ facility 3 where there is low probability of occurrence of the code sequences that cause increased error rates. However, he must be aware of the possible effects that this decision may have on his system operation and what steps he must take to recover from these situations when they arise.

As an aid in evaluating each situation individually, the following detailed description of the code-sensitivity condition is provided. Included are descriptions of the cause, the extent, and the recovery methods.

Situation

The *Bell System Data Communications Technical Reference* for the Western Electric Data Sets 201 indicates that the stability of the sync-recovery circuits is affected by repeated bit sequences that may occur in the data. These bit sequences, when they occur, produce excessive jitter in the recovered sync signal and can cause data errors.

In particular, Data Set 201B may be sensitive to repeated binary "one-zero" (1-0) bit sequences when operating on a Type 3002 Channel with C2 conditioning whenever the line characteristics barely meet the minimum requirements for this type of facility. This type of minimum facility is referred to as a "limiting channel." The code sensitivity is lessened and may not exist at all when the characteristics of the channel exceed the minimum requirements.

When Data Set 201B is operating on a "worst case" Type 3002 Channel with C2 conditioning and there is a sequence of more than 40 bits of the binary one-zero (1-0) bit pattern, then the receiving data set may lose phase synchronization with the transmitting data set. This loss of synchronization causes incorrect reception of bit values, which results in data errors. This condition may also occur when the majority of the bits transmitted are of the one-zero pattern, even though not in a sequence of 40 or more.

Besides being sensitive to the one-zero (1-0) bit sequence, Data Set 201B, when operating on a "worst case" Type 3002 Channel with C2 conditioning, is also sensitive to sequences of zero-one (0-1) bits. This alternate sensitivity is due to the data set transmitting the serial bits it receives from the business machine in pairs. The pairs—zero-zero, zero-one, one-zero, and one-one—are called dibits. The data set is sensitive only to the one-zero dibit; however, there is an equal probability that a sequence of alternate one and zero bits will be transmitted as either one-zero dibits or zero-one dibits. Likewise, a sequence of alternate zero and

one bits may be transmitted either as one-zero dibits or zero-one dibits. The particular state for any one transmission is the result of the relative timing between the business machine and the data set at the beginning of the transmission. A message may be transmitted in one state during one transmission, and in the other state during a subsequent retransmission.

The one-zero dibit recovery characteristics of Data Set 201B are shown in Figure 20. For the purposes of identification, the following definitions are made:

- Weak Dibit = the one-zero (1-0) dibit
- Weak Bits = A sequence of bits that results in at least one weak dibit
- Good Dibit = Non-weak dibit
- Good Bits = A sequence of bits that does not result in even one weak dibit

A good dibit occurring in the first 10 bits will cause the data set to return to the normal operating state (approximately center state). After 10 weak bits, a good dibit will compensate for two weak dibits; after 20 weak bits, a good dibit will compensate for only one weak dibit.

Scope

The types of data coding that the BSC procedures can accommodate and that must be considered for possible inclination to losing synchronization are analyzed below.

EBCDIC

The characters made up of the all one-zero bits ('AA')*, or the all zero-one bits ('55')*, are not defined in EBCDIC and

* The notation ' ' indicates a hexadecimal representation.

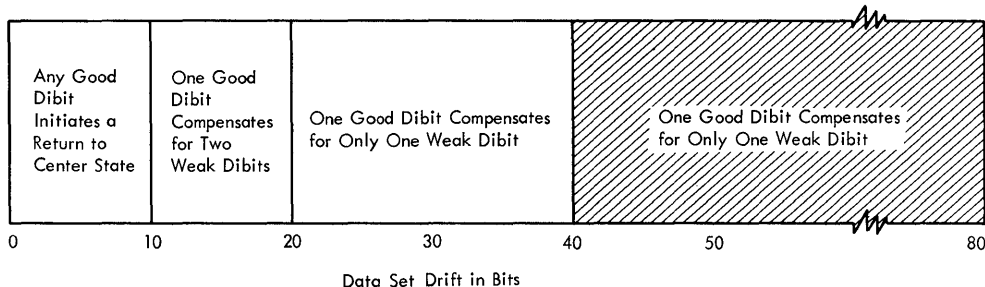

Legend:

- Weak Dibit - The "one-zero" (1-0) dibit
 - Weak Bits - Sequences of bits which result in the weak dibit
 - Good Dibit - any non-weak dibit
 - Good Bits - any bits which do not result in weak dibits.
-
- 0 to 40 Bits - in sync
 - 40 to 80 Bits - May go out of sync depending on quality of line.
 - 80 Bits - As far out of sync as the data set will go. If not out after 80 bits, it will not go out of sync.

Figure 20. Recovery Characteristics of Western Electric Data Set 201B

will therefore not be transmitted under this code. These characters will be restricted when they are defined in the future. The remaining EBCDIC characters have a sufficient mixture of dibits to prevent a loss of synchronization from occurring.

USASCII

All the characters in USASCII have a sufficient mixture of dibits to prevent a loss of synchronization from occurring. This characteristic of the USASCII code is a result of using the odd-parity bit.

Six-Bit Transcode

The Six-Bit Transcode allows for all the 64 possible character combinations of a six-bit code. Therefore, like transparent data, any and all character combinations can and will occur. The Transcode ESC and N characters consist of all one-zero and all zero-one bits, respectively. When these characters occur, they will allow the data set to drift out to a point where data with a high predominance of ESC or N characters could cause the data set to eventually lose synchronization. Therefore, when used in this restricted manner, Six-Bit Transcode can contribute to a synchronization problem. In normal use, the probability of losing synchronization is small.

Transparent Data

Packed Decimal. The packed-decimal '55' character consists of all zero-one bits. A sequence of more than five of these characters (55555555) may be encoded by the data set into 20 one-zero dibits (40 bits) and may therefore cause the data set to lose synchronization. A shorter sequence of fives, followed by characters with a great predominance of fives, may also cause the data set to lose synchronization. In either case, a prerequisite for the data set losing synchronization is that the data set must be out of sync with the character.

When the data set is pairing bits in synchronization with character phase (making an even four dibits of an eight-bit packed decimal character), and the zero-one character ('55') does not result in the weak one-zero dibit, a loss of synchronization will not occur. This is due to the fact that the all-binary one-zero character ('AA') does not occur in packed decimal. Therefore, when a packed-decimal message is blocked by a code-sensitive connection, it can be successfully transmitted by repeated transmissions.

Programs. In transmitting programs, the '55' or 'AA' characters occur at random. Unless specifically inserted as data or constants, sequences of these characters will normally occur only occasionally. Thus, in general applications the probability of either of these characters occurring in patterns sufficiently long to cause a loss of synchronization is low. The probability of having a data pattern that could

not be successfully transmitted (i.e., one having repetitive sequences of both '55' and 'AA' characters) is still lower.

Other Binary Data. The probability of sequences of '55' or 'AA' characters occurring in sufficient lengths to cause a loss of synchronization may be defined only with knowledge of the source. It must be assumed that such patterns can and will occur.

Summary

There are no inherent synchronization problems in transmitting either the EBCDIC or the USASCII code. For the transmission of Six-Bit Transcode and transparent data (packed decimal, programs, and other binary data), the code-sensitivity condition does not exist when any of the following communications facilities are used:

1. Data Set 201A, when operating on the switched telephone network.
2. Data Set 201A, when operating in a point-to-point or multipoint configuration on Type 3002 Channels with C2 conditioning.
3. Data Set 201B, when operating on Type 3002 Channel with C4 conditioning for point-to-point configurations and multipoint configurations that do not exceed four points.

The code-sensitivity condition will be encountered only with the combined condition of operating Data Set 201B over a 'worst case' Type 3002 Channel with C2 conditioning and transmitting a long sequence of binary one-zero (1-0) dibits.

Identifying a Code-Sensitive Channel

When the probability of obtaining data with weak patterns is low, the user may decide to take advantage of the code-sensitive facility. However, the user must be prepared to take proper steps to recover from messages that cannot be successfully transmitted using normal techniques.

Untransmittable data is recognized by a combination of timeouts and negative responses to a transmitted message. Normal error-recovery procedures will cause the retransmission of the message a number of times before posting a message to the operator. When the data contains either the EBCDIC 'AA' or '55' characters (N and ESC characters for Transcode), but not both, the error condition will probably clear, due to the scrambling effect of the data set, before an operator message is posted. However, when it does not clear, the operator receives a posting indicating that the message could not be successfully transmitted. At this point, there is no indication of whether or not the posted condition was caused by a code-sensitive connection and catalytic data. Therefore further isolation is necessary.

The operator should initiate steps to determine the existence of a code-sensitive connection. This procedure (outlined in Figure 21) uses predetermined sequences trans-

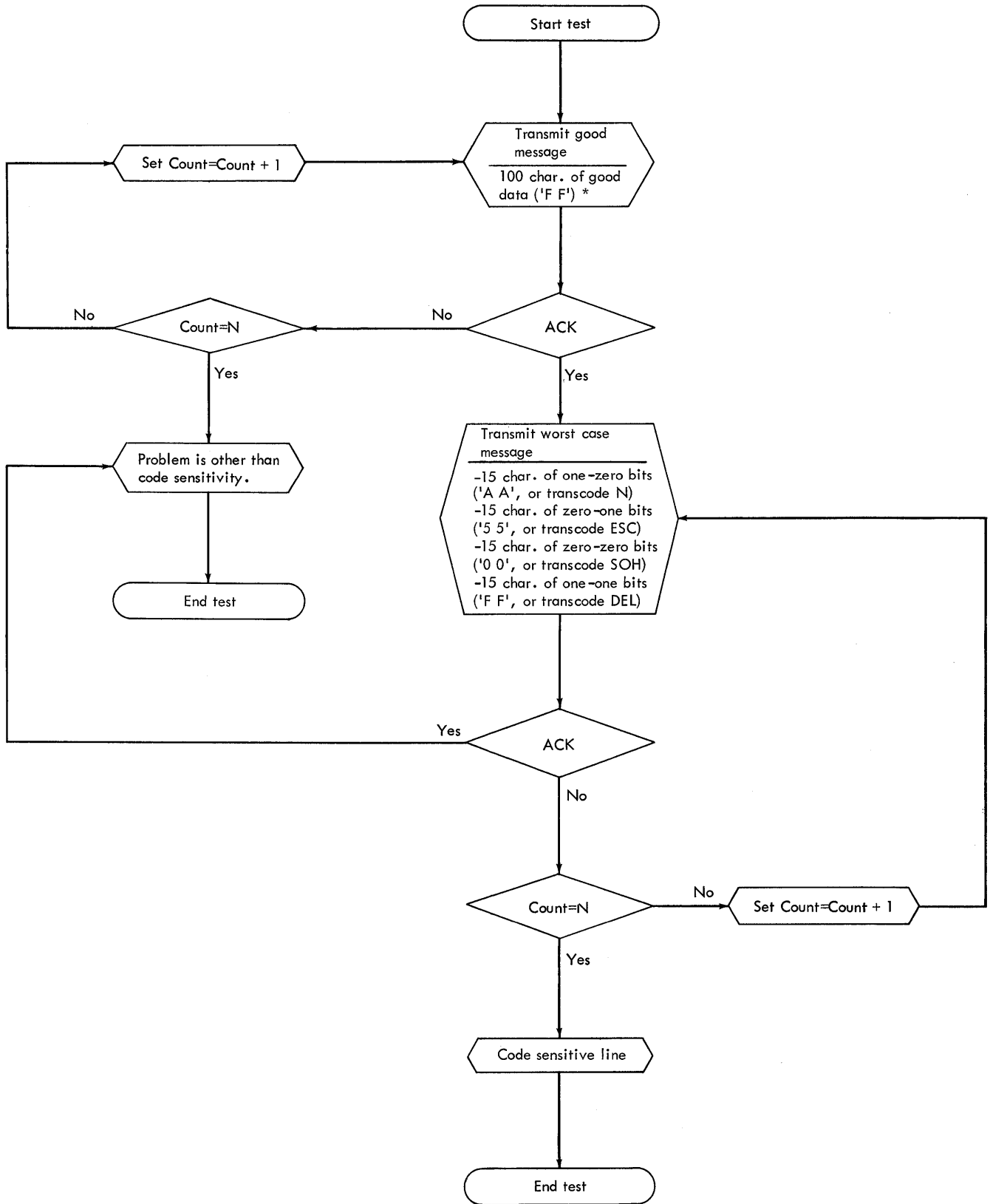

* This symbol ' ' indicates a hexadecimal representation

Figure 21. Procedure for Code Sensitivity Testing

mitted to the receiving terminal operator. These message sequences require that the terminal check and respond normally to the messages but disregard the contents of the text. First a known “good” message of approximately 100 characters (all ‘FF’) should be transmitted. If the response to this message is an ACK, then the connection may be assumed to be capable of transmitting a normal message. When a NAK response is received over several retries, a cause for the errors other than code sensitivity may be assumed, and normal error procedure followed.

Following an ACK response to the known good message, another test message should be transmitted. This time the message is made up of 15 contiguous (adjacent) characters of ‘AA’ (or N) followed by 15 contiguous characters of ‘55’ (or ESC), followed by 15 characters of ‘00’ (or SOH), and completed with 15 characters of ‘FF’ (or DEL). If the connection is code-sensitive, then this test message causes sync errors. This message should be transmitted at least three times seeking a NAK response to each transmission. Several timeouts may occur with each transmission due to loss of synchronization by the receiving data set. A single NAK response is not conclusive proof of code sensitivity. If any of the responses is ACK, the the connection should be assumed to be not code-sensitive, and normal error procedures should be followed. When the responses are all NAK, the connection may be assumed to be code-sensitive. Note that the existence of a code-sensitive connection does not imply that either the communications channel or the data set is failing. As previously stated, Data Set 201B operating over a “worst case” Type 3002 Channel with C2 conditioning may experience code sensitivity.

Recovery

Once code sensitivity has been established, several alternatives are available to the user. The original message may be printed out in order to determine the existence of sequences of both the ‘AA’ and ‘55’ characters (N and ESC). If the message contains one of the weak patterns but not both, then continued retransmission may be tried to allow the random operation with the data set dibit clock to remove the weak data patterns. If this is unsuccessful, or if sequences of both ‘55’ or ‘AA’ (ESC and N) exist, then alternate means must be used to handle the message. One such means is to “exclusive OR” the ‘C9’ (Transcode 9) or other scrambling character with each character in the message. First, however, send a message informing the receiving-station operator of the operation to be performed;

then transmit the scrambled message. This technique requires that the receiving station be able to unscramble the received message. If this technique is not desired or cannot be used, then alternate message routing should be used.

When the communications connection is identified to be code-sensitive and the frequency of occurrence of messages with weak patterns is high, then a change to a non-code-sensitive communications facility should be considered.

COMMUNICATIONS OVER WIDEBAND CHANNELS

Older Western Electric Data Set 303 series equipment is susceptible to losing synchronization any time it transmits a continuous sequence of more than 500 binary zero bits. This condition can be avoided by specifying (to the common-carrier representative when placing your order) that the data-set equipment should be delivered with a Universal Scrambler installed on each data set. The scrambler can be identified as a “16A1 Data Unit.” The specific equipment involved is Western Electric Wideband Data Stations 303B, 303C, 303D, and 303G.

Note: This condition is not relevant if the message traffic does not provide the possibility for transmission of a contiguous string of 500 or more zero bits at any time.

Western Electric Data Set 301B is not code-sensitive, and is capable of transmitting and receiving all code sequences without any effect on the bit synchronization. However, this set is classified as “Manufacture Discontinued” and may not be available for new installations. The 301B is being superceded by the 303G. Currently available wideband data-set equipment and the related operating speeds (in bits per-second—bps) are:

<i>Equipment</i>	<i>Speed</i>
Western Electric Wideband Data Station 303B	19,200 bps
Western Electric Wideband Data Station 303G	40,800 bps
Western Electric Data Set 301B*	40,800 bps
Western Electric Wideband Data Station 303C	50,000 bps
Western Electric Wideband Data Station 303D	230,400 bps

*301B-limited availability as described above.

BSC INTERMIX

BSC intermix capabilities allow different types of BSC stations to communicate with a System/360 functioning as a control station on a nonswitched multipoint communications system, or as a central station on a switched point-to-point communications system.

Various types of BSC stations (tributaries) can be multiplexed on leased or privately-owned communications facilities as shown in Figure 22. These devices may be IBM 1131's, 1826's, 2715's, 2772's, 2780's, or System/360 Model 20's.

On the common-carrier switched telephone network, the various stations can communicate point-to-point with the System/360 central station (Figure 23). These remote stations may be System/360's Models 25 through 91 (including Model 67 operating in 65 mode, but excluding Model 44 and Model 67 operating in 67 mode) with a 2701 or 2703 attached, Model 25 with the Integrated Communications Attachment (ICA), 2780's, 1131's, 1826's, 2715's, 2772's, or System/360 Model 20's.

The central or control station for the switched or non-switched communications system may be a System/360, Models 25 through 91 (including Model 67 operating in 65 mode, but excluding Model 44 and Model 67 operating in 67 mode) with a 2701 or 2703 attached, or a System/360 Model 25 with the Integrated Communications Attachment (ICA).

Programming support for the various models of System/360 is provided by DOS BTAM, OS BTAM, or BOS/BPS, as shown in Figures 22 and 23.

BSC devices have a variety of features and capabilities (see the associated Component Description SRL for the specific machine or system). Some combinations of machines require that certain features, capabilities, and data-link control characters be used selectively, or not at all. These capabilities, optional features, and special features having restricted usage when used in a BSC intermix con-

figuration, and features which are not available on a particular unit are shown in Figure 24. Restrictions imposed by availability of IBM-supplied program support, as noted in Figure 24 (Note 1), are found in the programming systems SRL's for the specific type of programming used. For detailed information on implementation of BSC related to a specific machine or system, consult the Component Description manual for that unit.

BSC INTERMIX RULES

Operation with BSC intermix requires that certain rules be followed throughout the communications system. The following rules apply to all stations (control, tributary, and point-to-point) on the same nonswitched multipoint or switched point-to-point communications facility:

1. All stations must use the same type of data set (not a requirement in W.T.C.).
2. Data Sets must have the same features.
3. All stations must use the same transmission code, either EDCDIC or USASCII.
4. Bit rate must be the same for all BSC devices.
5. The method of clocking must be the same for all stations in the system, whether data set clocking or business machine clocking.
6. The type of line facility (duplex or half-duplex) must be the same for all devices on a line.
7. On the switched network, when terminal identification is used, all stations using the same termination (phone number) at the central computer may use different identification sequences.
8. In a multipoint network, the control station must use the same number of characters in the common polling list. (If the terminals have different length addresses, the shorter addresses must be extended by placing leading SYN characters in the polling list.)

TRIBUTARY STATIONS

CONTROL STATION

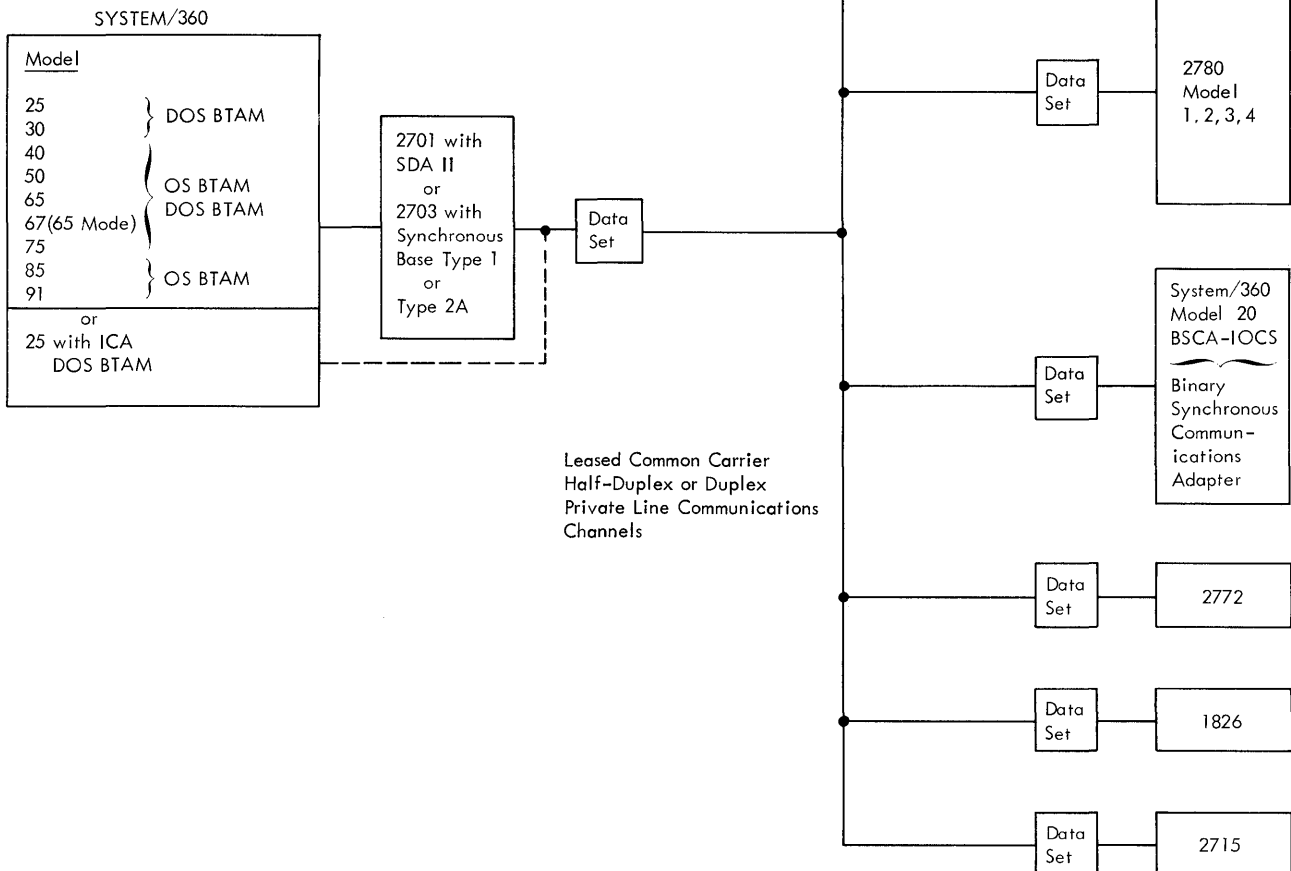
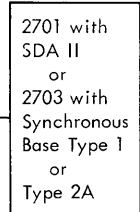
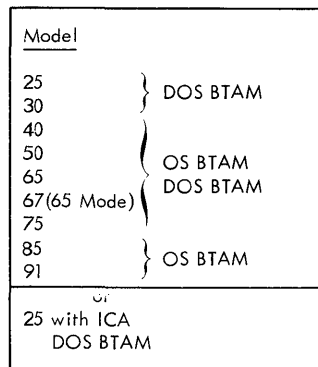

Figure 22. BSC Intermix-Multipoint

CENTRAL STATION

SYSTEM/360



Switched Network

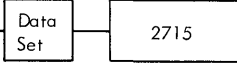
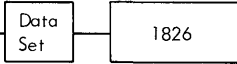
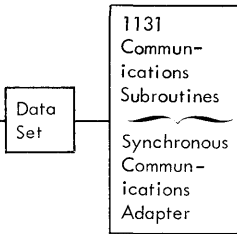
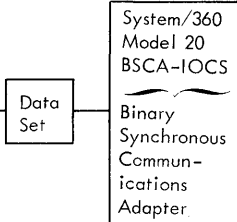
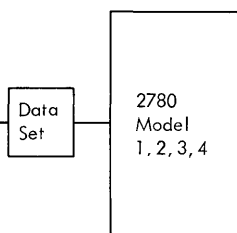

SYSTEM/360

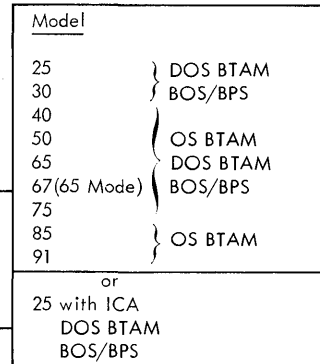

Note: The System/360 and any one of the other stations in this figure can also be used on a nonswitched point-to-point line.

Figure 23. BSC Intermix--Switched Point-to-Point

	2701 (SDA II)	2703 (Synchronous Base Type 1 or Type 2A)	S/360 M25 (ICA)	S/360 M20	1131	2780	2772	2715	1826
EBCDIC or USASCII (1,2)	Specify (1)	Specify (1)	Specify (1)	Specify	EBCDIC Only	Specify	Specify	EBCDIC Transparent Only	Specify
Six-Bit Transcode	Specify	Specify	Specify	Not Available	Not Available	Specify	Not Available	Not Available	Not Available
EBCDIC (1) Transparency	Special Feature	Standard	Standard	Special Feature	Standard	Special Feature	Special Feature	Standard	Specify
USASCII Transparency	Special Feature	Special Feature	Special Feature	Special Feature	Not Available	Not Available	Not Available	Not Available	Not Available
Multipoint (3)	Standard (Control Station Only)	Standard (Control Station Only)	Standard (Control Station Only)	Special Feature (4)	Standard (4)	Special Feature (4)	Special Feature	Specify (Expanded capability feature required)	Specify
Terminal (1) Identification (Switched Network)	Standard	Standard	Standard	Standard	Standard	Special Feature	Standard	Standard	Specify
ITB (1)	Standard	Standard	Standard	Standard	Standard	Standard	Standard (5)	Standard (5)	Standard
RVI (1)	Standard	Standard	Standard	Standard	Standard (5)	Standard (5)	Standard (5)	Standard	Standard
WACK (1)	Standard	Standard	Standard	Standard (5)	Standard (5)	Standard (5)	Standard	Standard	Standard
TTD (1)	Standard (5)	Standard (5)	Standard (5)	Standard	Standard (5)	Standard (5)	Standard	Standard (5)	Standard
Limited Conversational Mode	Standard	Standard	Standard	Standard	Not Available	Not Available	Special Feature	Not Available	Not Available

Note: This chart is intended to show only those features or capabilities having restricted usage in an intermixed configuration, and does not show all features which are available for these devices.

1. Refer to appropriate programming SRL for information concerning program support, implementation, or restrictions on the use of this feature.
2. Code must be the same for all devices on a line.
3. Multipoint operation on nonswitched network.
4. Multipoint operation on nonswitched network as tributary station.
5. Receive only.

Figure 24. Feature Capabilities

BSC point-to-point intermix capabilities allow communication between any two of the following units: System/360 Model 20 Submodels 2, 4, or 5, 1130 Computing System, 2780 Data Transmission Terminal, 2770 Data Communication System, and 1800 Data Acquisition and Control System. These capabilities are in addition to the central-remote communication between these devices and the System/360 Models 25 through 91 discussed in the section Planning Considerations for BSC Intermix.

Interconnection facilities can be dial-up communications facilities at 1200 or 2000 bits per second, or privately-owned or common-carrier leased point-to-point communications facilities at 1200, 2000, 2400, or 4800 bits per second. (Exception: The 2770 cannot operate at 4800 bits per second.) Dial-up communications facilities are also available at 600 bits per second for World Trade data sets.

Programming support for BSC point-to-point intermix is provided by the System/360 Model 20 BSCA IOCS program, the 1130 communications subroutines (EBCDIC only), and the 1800 communications subroutines (MPX-Version 2 with BSCIO).

BSC devices have a variety of features and capabilities, as described in the SRL Component Description manual for the specific machine or system. Some combinations of machines require that certain features be used selectively or not at all. These limitations are discussed in the following sections. Figure 25 shows feature restrictions.

For detailed information on the use of BSC related to a specific machine or system, consult the SRL Component Description manual for that unit.

INTERMIX RULES

BSC point-to-point intermix operation requires that the following rules be followed for both stations on the point-to-point communications facility.

1. The same type of communications data set must be used on domestic common-carrier private line facilities. Approved IBM modems or common-carrier data sets must be used on domestic switched network facilities. The modems or data sets must be end to end compatible with each other.
2. Both stations must use the same transmission code and operate at the same speed.
3. Transparency on the System/360 Model 20 and the 1800 in a point-to-point configuration with an 1130, 1800, 2770, or 2780 can be EBCDIC Transparency only.
4. Message formatting must comply with the buffer restrictions of the receiving station.

INPUT/OUTPUT AND FORMAT RESTRICTIONS

Transparent mode must be used for all data transmitted between a 2770 and 2780.

When a 2770 is transmitting to a 2780, the message may be sent from the 2502 Card Reader in the 2770 system to either the printer (80 character printer only) or the card punch of the 2780 system.

When a 2780 is transmitting to a 2770, the message must be sent to the 545 Card Punch or to the 2213 Printer of the 2770 system. If a System/360 Model 20, 1130, or 1800 is transmitting to the 2770, the message can be sent to any output in the 2770 system.

No 50 MDI Edit Macro is supplied with the 1130, 1800, or System/360 Model 20. Therefore, if one of these CPU's is to communicate with the 2770's IBM 50 Magnetic Data Inscrber, the customer must supply the edit routine.

For a point-to-point connection between the 2770 and 2780, the units must have the following features and limitations:

2770

1. Expanded Buffer (# 1490)
2. EBCDIC Code (# 9761)
3. EBCDIC Transparency (# 3650)
4. Terminal Use (# 9711)*

2780 (Models 1, 2, and 4)

1. EBCDIC Code (# 9762)
2. EBCDIC Transparency Feature (# 8030)
3. Terminal Use (# 9711)*
4. Limitation: Multiple Record Transmission (# 5010) cannot be installed.
5. 120 and 144 Print Line Features (# 5820 and # 5821) cannot be installed.

For specific information concerning terminal setup for output on a desired device and message formatting, refer to *SRL System Components, IBM 2770 Data Communication System, GA27-3013* and *SRL IBM 2780 Data Transmission Terminal, Component Description, GA27-3005*.

SYSTEM/360 MODEL 20 TO 2770 OR 2780 (SWITCHED LINE)

Abort Sequence

When a System/360 Model 20 communicates with a 2770 or 2780 over a switched line, the abort sequence for the

*When a 2770 or 2780 communicates alternately with a CPU and a 2770 or 2780, feature #9711 should be specified.

Model 20 differs from that sent by the 2770 or 2780. The abort sequence transmitted by the Model 20 is DLE EOT. The abort sequence sent by the 2770 and 2780 is EOT. In both cases, the abort outcome is indicated in the TECB of the System/360 Model 20 BSCA IOCS.

If DLE EOT is sent or received, the line is disconnected. The user must issue a 'write connect' or a 'read connect' to re-establish the connection. If EOT is sent or received, the user must issue a 'write initial' or 'read initial' to continue transmission.

When an abort has been received or transmitted, a 'write disconnect' must not be issued because this macro would be bypassed and no DLE EOT would be sent.

Buffer Limitations (2770)

When the Model 20 finishes transmission to one output device of a 2770, and the user wants to select another output device on the 2770 immediately afterwards, the 2770 will still be transferring data from the buffer to the first output device. The 2770 responds with NAK. The Model 20 BSCA IOCS does not retry ENQ (in the 'write initial' macro)

when NAK is received as a response, but gives control to the user immediately. The user's program must re-issue the 'write initial' for the time required for the 2770 to empty the buffer. The time required depends on the record length and the speed of the output device.

Error Checking (2770)

For communication between a System/360 Model 20 and a 2770, the BSCA IOCS does not provide a means for analyzing an error message sent by the 2770. It is completely up to the user to take action for receiving and analyzing the error message.

PROCEDURES FOR ESTABLISHING A CALL (SYSTEM/360 MODEL 20)

Figures 26 through 34 show the recommended procedures for initially establishing a call and for re-establishing the data exchange if the exchange cannot be started or cannot continue.

	360 M/20	1130	1800	2780	2770
Transmission Code (1,2)	EBCDIC or USASCII (1)	EBCDIC Only	EBCDIC or USASCII (1)	EBCDIC or USASCII (1)	EBCDIC or USASCII (1)
EBCDIC Transparency (1)	Special Feature	Standard	Standard	Special Feature	Special Feature
ITB (1)	Standard	Standard	Standard	Standard	Standard (4)
RVI (1)	Standard	Standard (4)	Standard	Standard (4)	Standard
WACK (1)	Standard (4)	Standard (4)	Standard	Standard (4)	Standard
TTD (1)	Standard	Standard (4)	Standard	Standard	Standard
Point-to-Point	Specify	—	—	Specify	Specify
Required Core Storage	8K Bytes (6)	8K Words (3, 5)	8K Words (5)	—	—

1. Refer to appropriate programming SRL for information concerning program support, implementation, or restrictions on the use of this feature.
2. Code must be the same for both stations. EBCDIC code must be used when one of the machines is an 1130, or when communication is between a 2770 and 2780.
3. For a System 360 Model 20 or 1800 to 1130 point-to-point connection, only 4K of core storage is required for the 1130.
4. Receive only.
5. Required for diagnostics, not an operating system or control program requirement.
6. 8K for CPS, 12K for TPS or DPS.

Figure 25. Feature Restrictions for BSC Point-to-Point Intermix

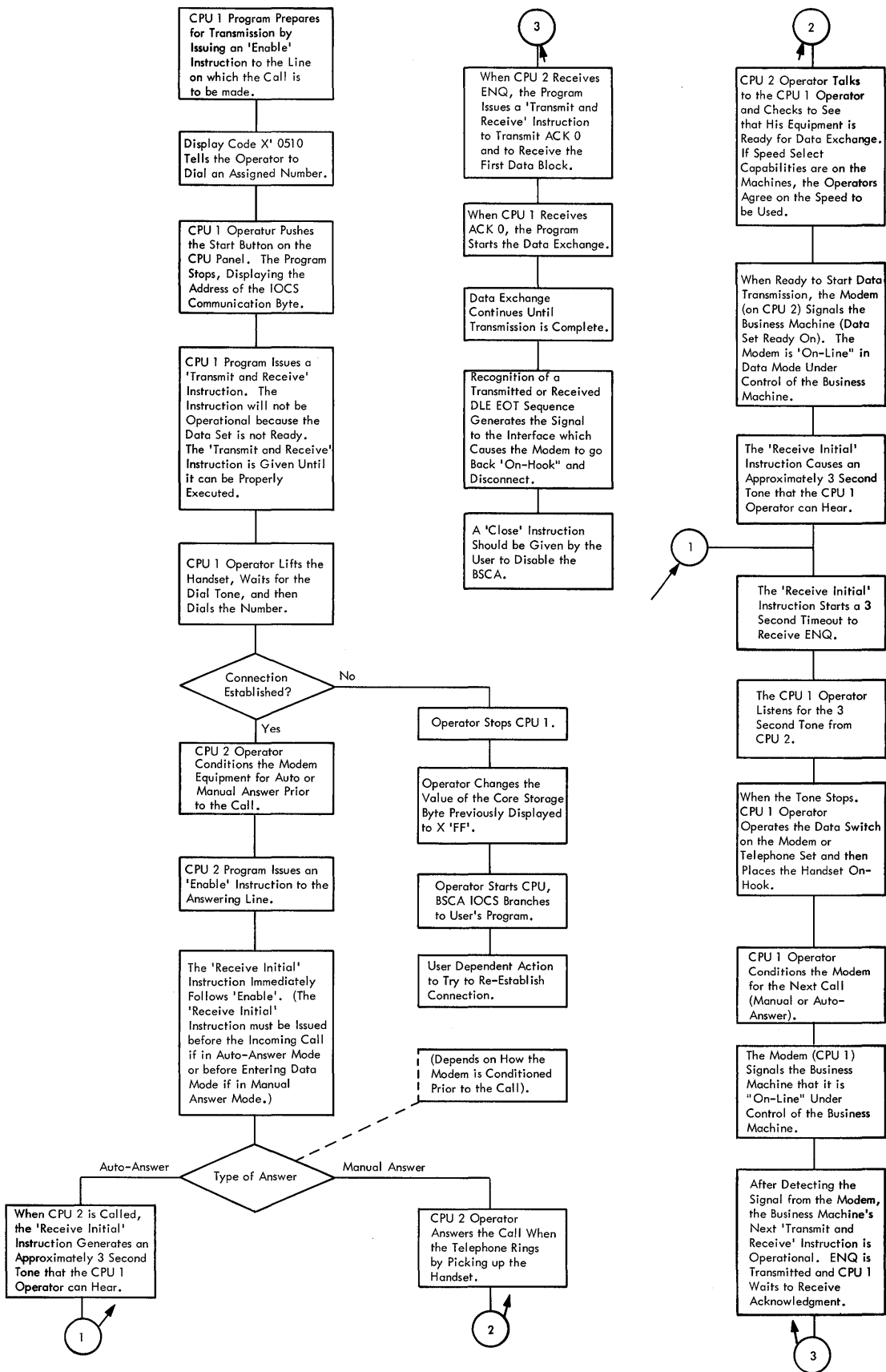

Figure 26. Establishing a Call (System/360-to-System/360)

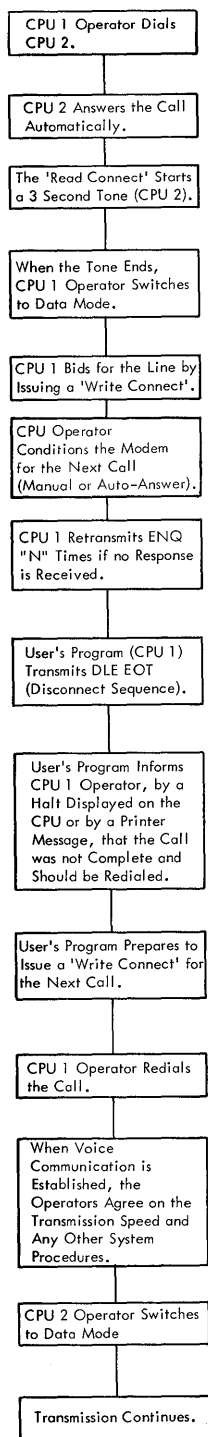

Figure 27. Transmission Fails to Start (System/360-to-System/360)

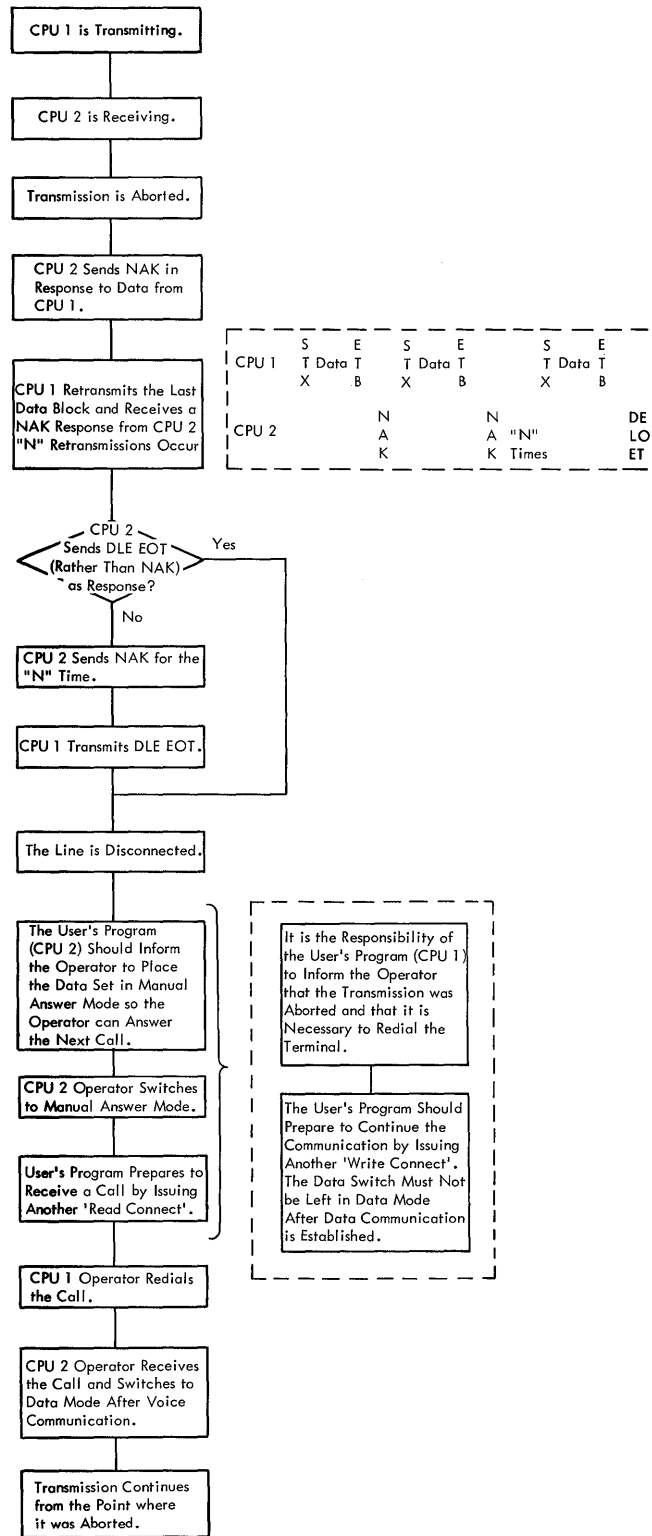
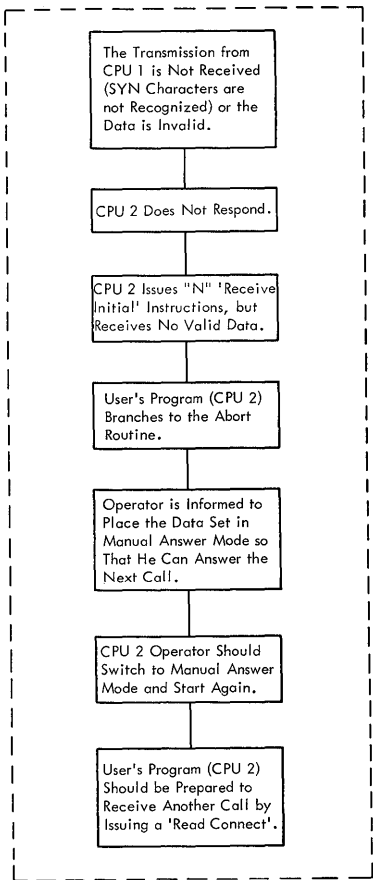

Figure 28. Transmission Unable to Continue (System/360-to-System/360)

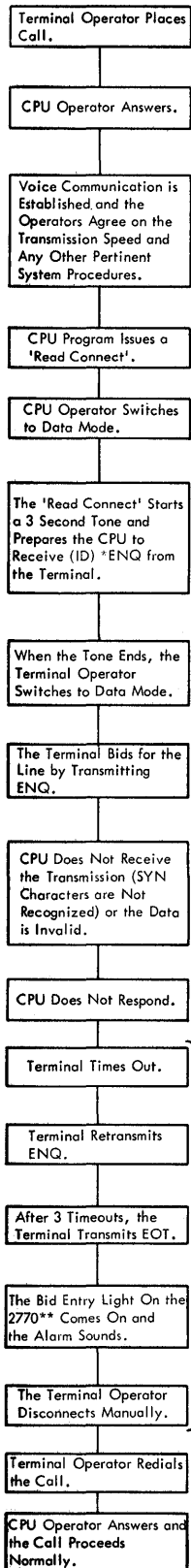

Figure 29. Transmission Fails to Start—Manual Answer (2770 or 2780-to-System/360)

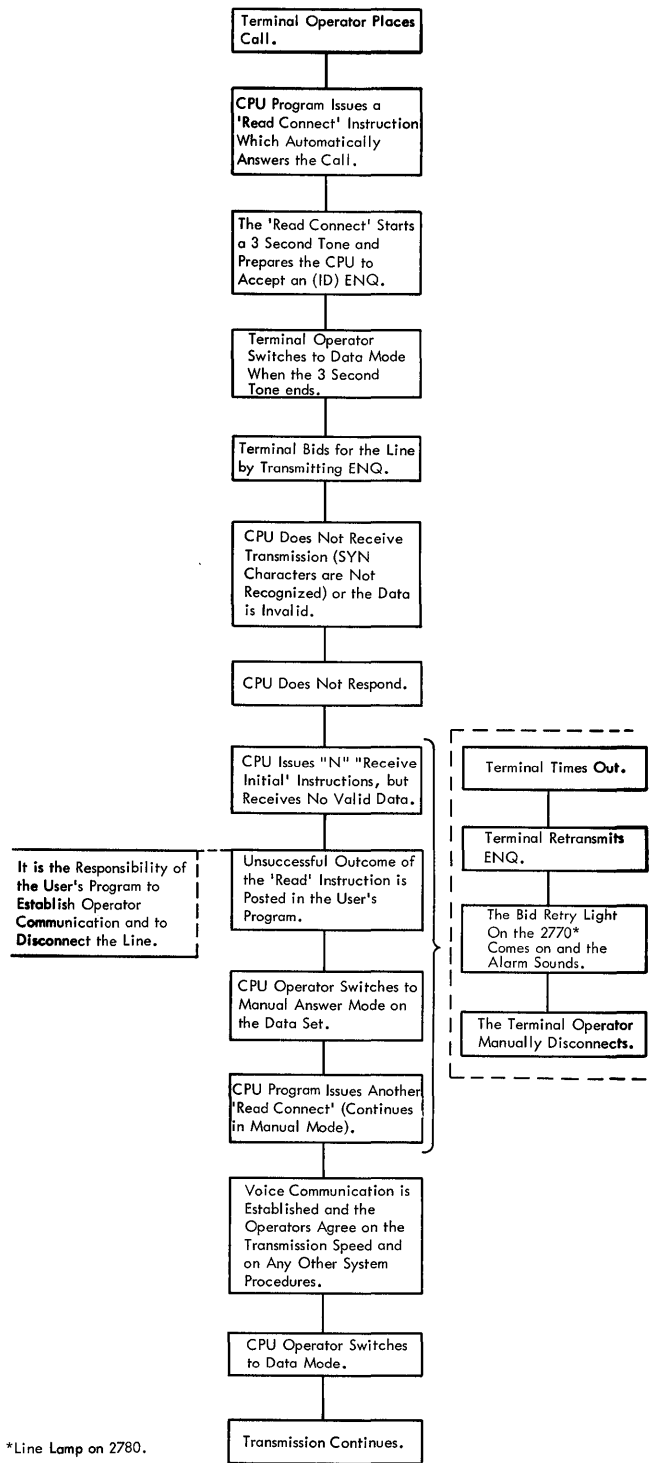
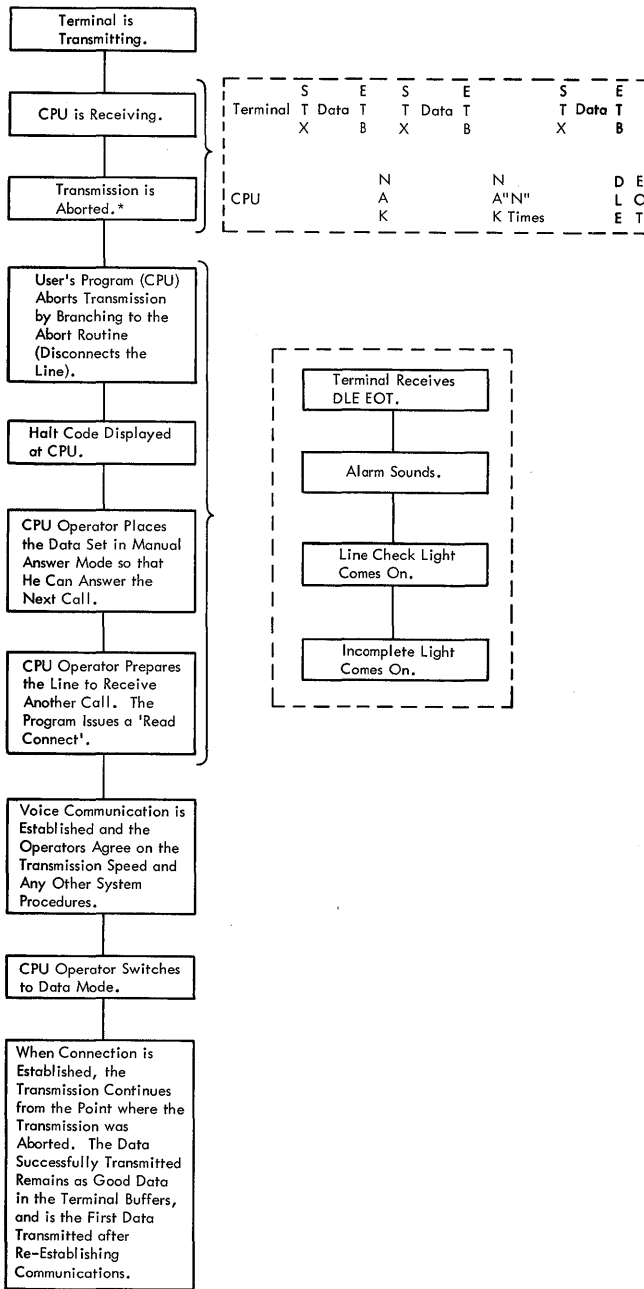

Figure 30. Transmission Fails to Start—Automatic Answer (2770 or 2780-to-System/360)



*Customers can program their system to audit the number of retransmissions and force an abort. By programming, an abort can be forced before a specific block has been retransmitted "N" times if the frequency of retransmissions is excessive and significantly affects throughput. The operators would establish voice communication and proceed as above.

Figure 31. Transmission Unable to Continue (2770 or 2780-to-System/360)

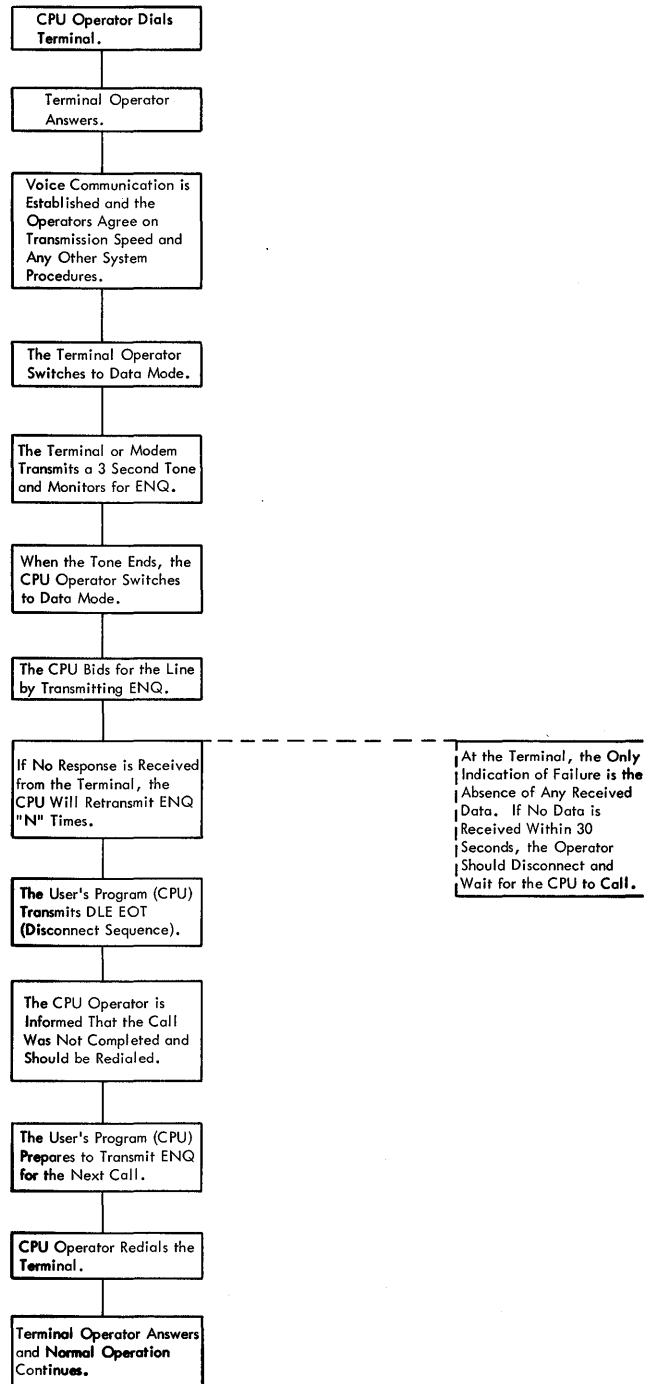
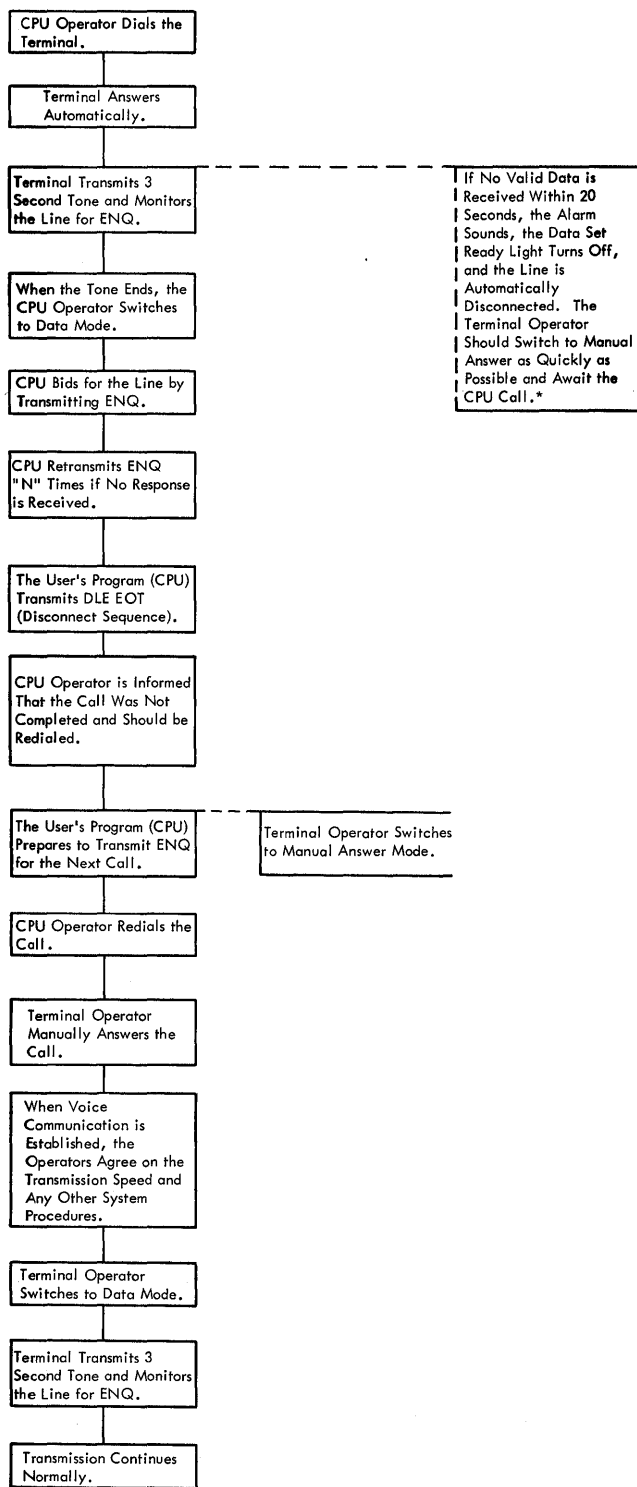
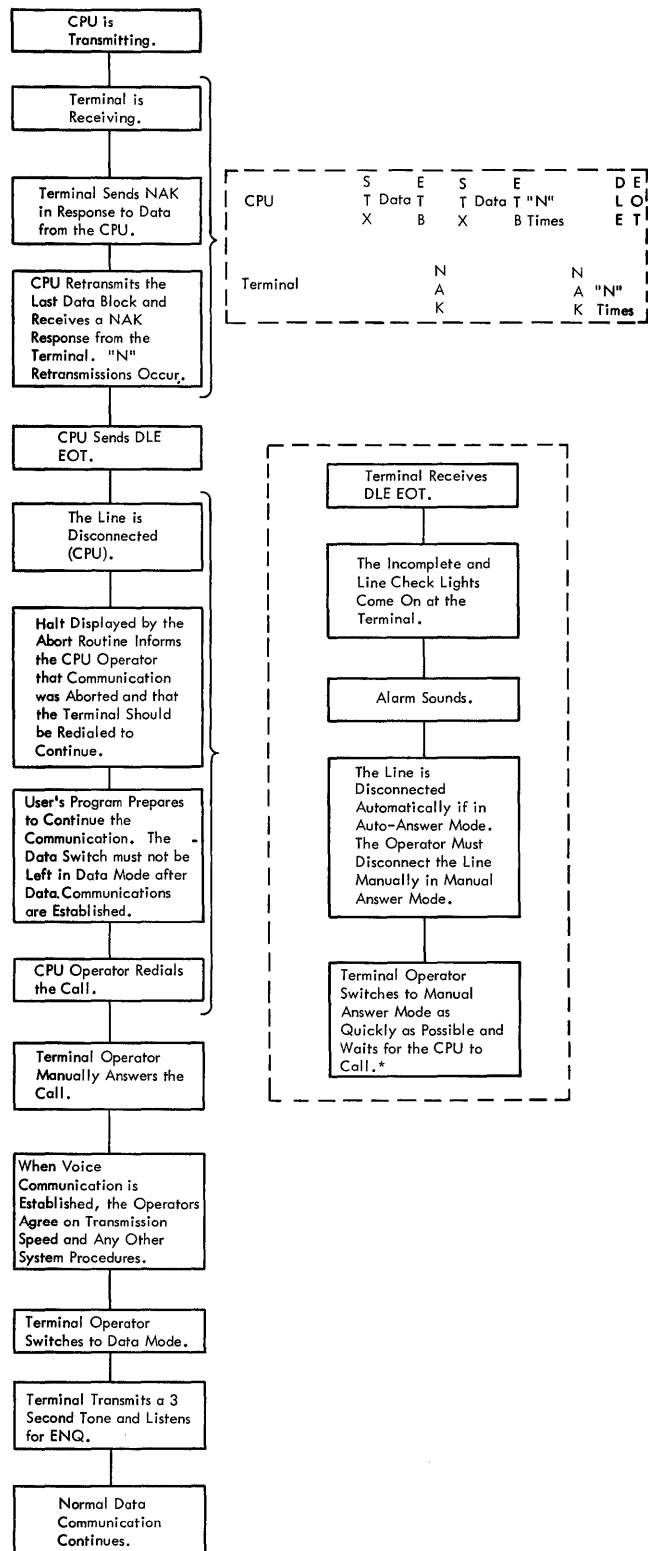

Figure 32. Transmission Fails to Start-Manual Answer (System/360-to-2770 or 2780)



*If the CPU call is received before the terminal operator switches to manual answer, the terminal answers the call automatically, generates the 3 second tone, and monitors the line for ENQ. The CPU operator should switch to data mode to retry the transmission at the original line speed. If data communications are not established, the alarm at the terminal will sound again.

Figure 33. Transmission Fails to Start—Automatic Answer (System/360-to-2770 or 2780)



CPU	S	E	S	E	D
	T	Data	T	Data	T
	X	B	X	B	"N"
					Times
Terminal		N		N	
		A		A	"N"
		K		K	Times

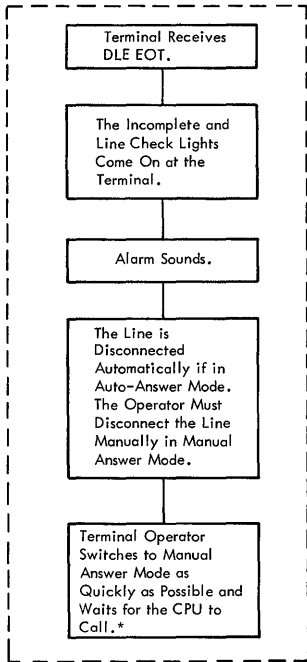

*If the CPU call is received before the terminal operator switches to manual answer mode, the terminal automatically answers the call, generates the 3 second tone, and listens for ENQ. The CPU operator should switch to data mode and retry the transmission at the original line speed.

Figure 34. Transmission Unable to Continue (System/360-to-2770 or 2780)

ACK 0, ACK 1 (affirmative acknowledgment): These replies (DLE sequences), indicate that the previous transmission block was accepted by the receiver and that it is ready to accept the next block of the transmission. Use of ACK 0 and ACK 1 alternately provides sequential checking control for a series of replies. ACK 0 is also an affirmative (ready to receive) reply to a station selection (multipoint), or to an initialization sequence (line bid) in point-to-point operation.

BSC (binary synchronous communications): A uniform procedure, using a standardized set of control characters and control character sequences, for synchronous transmission of binary-coded data between stations in a data communications system.

BSC intermix: Capability of different types of BSC stations on the same multipoint line, or using the same switched line termination (phone number) at the central computer, to communicate with a control or central station using BSC procedures.

Central station: Term applied to a central computer in a data communications system, because of the function it performs as the main processor of information communicated over the system.

Control station: The station (usually a CPU) in a multipoint data communications system that controls network traffic by means of polling and selection. On a centralized multipoint network, tributary stations can communicate only with the control station when polled or selected by the control station.

DLE (data link escape): A control character used exclusively to provide supplementary line-control signals (control character sequences or DLE sequences). These are two-character sequences where the first character is DLE. The second character varies according to the function desired and the code used.

Duplex channel: A communications facility capable of transmitting in both directions simultaneously.

ENQ (enquiry): Used as a request for a response to obtain identification and/or an indication of station status. Transmitted as part of an initialization sequence (line bid) in point-to-point operation, and as the final character of a selection or polling sequence in multipoint operation.

EOT (end of transmission): Indicates the end of a transmission, which may include one or more messages, and resets all stations on the line to control mode (unless it erroneously occurs within a transmission block). EOT is also transmitted as a negative response to a polling sequence.

ETB (end of transmission block): Terminates a group of characters (transmission block) started with SOH or STX, and indicates that the message continues with a following block. A message may con-

tain one or more transmission blocks ending with ETB. The block check character is sent immediately following ETB. ETB requires a reply indicating the receiving station's status.

ETX (end of text): Indicates the end of a message. If multiple transmission blocks are contained in a message, ETX terminates the last block of the message. (ETB is used to terminate preceding blocks.) The block check character is sent immediately following ETX. ETX requires a reply indicating the receiving station's status.

Half-duplex channel: A communications facility capable of transmitting in both directions, but not at the same time.

ITB (intermediate text block): This character (actually IUS or US depending on code) is used to terminate an intermediate block of characters. The block check character is sent immediately following ITB, but no line turnaround occurs. The response following ETB or ETX also applies to all of the ITB checks immediately preceding the block terminated by ETB or ETX.

NAK (negative acknowledgment): Indicates that the previous transmission block was in error and the receiver is ready to accept a retransmission of the erroneous block. NAK is also the "not-ready" reply to a station selection (multipoint) or to an initialization sequence (line bid) in point-to-point operation.

Remote station: (Multipoint): synonymous with tributary station. (Point-to-point switched network) a station that can be called by the central station, or can call the central station if it has a message to send.

RVI (reverse interrupt): A control character sequence (DLE sequence) sent by a receiving station instead of ACK 1 or ACK 0 to request premature termination of the transmission in progress.

SOH (start of heading): Precedes a block of heading characters.

STX (start of text): Precedes a block of text characters.

SYN (synchronous idle): Character used as a time fill in the absence of any data or control character to maintain synchronization. The sequence of two contiguous SYN's is used to establish synchronization (character phase) following each line turnaround.

Tributary station: A station, other than the control station, on a centralized multipoint data communications system, which can communicate only with the control station when polled or selected by the control station.

TTD (temporary text delay): A control character sequence (STX, . . . ENQ) sent by a transmitting station to either indicate a delay in transmission or to initiate an abort of the transmission in progress.

WACK (wait before transmit positive acknowledgment): This DLE sequence is sent by a receiving station to indicate that it is temporarily not ready to receive.

- abort sequence 34.1
- ACK 0 13
- ACK 1 13
- affirmative acknowledgment 13
- alternating affirmative acknowledgment 15
- BCC 9
- bit phase 21
- block checking 17
- BSC concepts 7
- BSC intermix 31
- BSC point-to-point intermix 34.1
- buffer limitations (2770) 34.2
- character conversion chart 12
- character phase 18
- circuit assurance mode 24
- code-insensitive facilities 25
- code sensitivity 25, 26
- code sensitivity (identification) 27
- code sensitivity (recovery from error) 29
- communication (switched facilities) 25
- communication (voice-grade lines) 25
- communication (wideband channels) 29
- contention 18
- continue timeout 22
- control characters 11
- control station 5, 18
- conversational mode 23
- CRC-12 9
- CRC-16 9
- data link 5
- data-link concept 5
- data-link control 11
- data link escape 13
- data sets 25
- disconnect sequence 15, 24
- disconnect timeout 22
- DLE 13
- DLE EOT 15, 34.2
- EBCDIC 7, 8, 9, 26
- edit micro 34.1
- end of intermediate transmission block 12
- end of text 12
- end of transmission 12
- end of transmission block 12
- ENQ 13
- enquiry 13
- EOT 12, 34.2
- EOT/NAK pad format check 10
- error checking 9, 34.2
- ETB 12
- ETX 12
- forced error condition 17
- format restrictions, BSC point-to-point intermix 34.1
- forward abort 13
- good bits 26
- good dibits 26
- headings 17
- identification sequence 24
- initialization phase 19
- introduction 5
- input/output restrictions, BSC point-to-point intermix 34.1
- ITB 12
- intermix rules 34.1
- leading graphics 24
- limited conversational mode 23
- loss of synchronization 26
- LRC 9
- message blocks 7
- message formats 17
- message sync 21
- multipoint data link 5
- multipoint operation 18
- NAK 13
- negative acknowledgment 13
- operation of the data link 7
- packed decimal 27
- pad characters 21
- planning considerations (BSC) 25
- planning considerations (BSC intermix) 31
- planning for multipoint network 25
- point-to-point data link 5, 18
- point-to-point intermix 34.1
- polling 7
- primary station 18
- priority 18
- procedure for establishing a call 34.2
- programs 27
- programming support 34.1
- receive timeout 21
- reverse interrupt 13
- RVI 13
- secondary station 18
- selection 7
- situation 26
- six-bit transcode 7, 12, 27
- SOH 12
- SOH% 8
- start of heading 12
- start of text 12
- station address 7
- STX 12
- switched-network operation 23
- SYN 12
- sync-idle signals 21
- sync patterns 18
- synchronous idle 12
- temporary text delay 13
- text 17
- timeouts 21
- transmission codes 7
- transmit timeout 21
- transparent data 27
- transparent-text mode 23
- tributary station 18
- TTD 13
- units, point-to-point intermix 34.1
- USASCII 7, 10, 11, 27
- voice-grade lines 25
- VRC/LRC 9
- WACK 13
- wait before transmit positive acknowledgment 13
- weak bits 26
- weak dibits 26
- wideband channels 29

YOUR COMMENTS, PLEASE . . .

This publication is one of a series that serves as a reference source for systems analysts, programmers, and operators of IBM systems. Your answers to the questions on the back of this form, together with your comments, help us produce better publications for your use. Each reply is carefully reviewed by the persons responsible for writing and publishing this material. All comments and suggestions become the property of IBM.

Please note: Requests for copies of publications and for assistance in using your IBM system should be directed to your IBM representative or to the IBM sales office serving your locality.

Cut Along Line

Fold

Fold

FIRST CLASS
PERMIT NO. 569
RESEARCH TRIANGLE PARK
NORTH CAROLINA

BUSINESS REPLY MAIL
NO POSTAGE STAMP NECESSARY IF MAILED IN U. S. A.

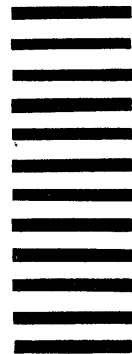

POSTAGE WILL BE PAID BY . . .

IBM Corporation
P. O. Box 12275
Research Triangle Park
North Carolina 27709

Attention: Publications Center, Dept. E01

Fold

Fold

IBM-SC--General Information (TP-09)

Printed in U.S.A. GA27-3004-2



International Business Machines Corporation
Data Processing Division
1133 Westchester Avenue, White Plains, New York 10604
(U.S.A. only)

IBM World Trade Corporation
821 United Nations Plaza, New York, New York 10017
(International)



International Business Machines Corporation
Data Processing Division
1133 Westchester Avenue, White Plains, New York 10604
(U.S.A. only)

IBM World Trade Corporation
821 United Nations Plaza, New York, New York 10017
(International)