

GENERAL INFORMATION, CONSOLE OPERATION, SPECIAL DEVICES

This bulletin is the first of a series of bulletins on the 650 System. It obsoletes parts of the 650 Manual of Operation (Form 22-6060) and all of the 654 Manual of Operation (Form 22-6367).

General Information

The IBM 650 has all the advantages of stored programming: high component reliability, self-checking automatic operation, compact design, and ease of operation. Because of its great flexibility, the IBM 650 serves the needs of accounting, engineering, and scientific fields efficiently.

Functional Configuration

Control of the 650 system is exercised through the medium of a stored program. It has, as do most data processing systems, an integration of four basic functional blocks (Figure 1). We must remember that although the hardware of a 650 system can vary, the basic philosophy of these four blocks does not change. For example, the 533 Card Read Punch, the 537 Card Read Punch, or the 407 Accounting Machine can be used as a card input machine for this system.

Input-Output

The input block is used to enter transaction data, instructions, etc., into the storage block of the system. In the 650 system, the input usually takes the form of units capable of reading and translating IBM cards into 650 language.

The output block is used to take the results of processing out of the system, and convert from 650 language to output language. The output devices usually take the form of units capable of punching IBM cards, or printing a report on paper.

Input-output units for the 650 can be combined into various physical configurations to meet the varying needs of diversified users. Their operation is supervised by the control block.

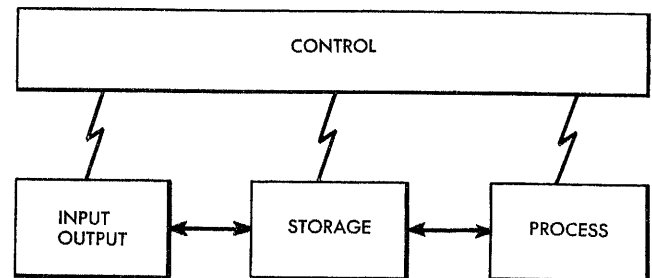

Figure 1. Basic Data Processing System

The use of magnetic tape as both input and output media is discussed in a later 650 Bulletin, Form G24-5003.

Storage

The storage block of the system is used for storing transaction data, instructions, tables, intermediate results, final results, historical data, summary files, master records, and any other information that can profitably be stored within the machine. The physical form that the storage takes is determined by the amount and type of data to be stored, and the frequency of its use. The 650 system uses four types of magnetic storage:

1. drum
2. core
3. tape
4. disk

Each of these media is characterized by the high speed with which records can be read from and written into it.

The movement of data into or out of storage is supervised by the control block.

Process

The process block manipulates the data. Addition, subtraction, multiplication, and division are performed here. Comparisons, on which logical decisions are based, are made here. Information is shifted either right or left, decimal points are aligned, editing is performed, or data is rearranged for a more logical flow. In short, the work is done here.

In the 650 system, this block can accumulate 10-digit factors to produce 20-digit totals; multiply two 10-digit factors to produce a 20-digit product; and divide a 20-digit factor by a 10-digit factor, to produce a 10-digit quotient and a 10-digit remainder. Complete automatic sign control is provided.

Control

The control block could be called the nerve center of the data processing system:

- It receives each instruction of the program and analyzes it to determine the operation to be performed.

- It controls the actual execution of the operation.

- It monitors and supervises the flow of data within the system, assuring that all data being processed is valid.

- It notifies the operator when manual intervention is required.

- In conjunction with the program and the operator, it assures an even, efficient flow of work through the system, and further assures that the results obtained are valid and error-free.

Unit Configuration

Here are the various units that can be used to make up an IBM DATA PROCESSING SYSTEM. These units integrate and come under the logical blocking shown in Figure 1.

Input-Output

533 Card Read Punch (Figure 2). This unit combines two machines on one base. The read unit has a maximum input rate of 200 cards (16,000 digits) per minute. The punch unit has a maximum output rate of 100 cards (8,000 digits) per minute. Operations involving one of the units does not affect the other. A control panel is provided to achieve flexibility of card format on input and output. The operation of these units is controlled by the stored program.

537 Card Read Punch (Figure 3). This unit is a combination input-output device. Because the reading and punching are done in one unit, it is possible to punch the results of processing into the same card from which the factors are read. This device can be used for input alone, or for output alone. The maximum input-output rate is 155 cards per minute. A control panel, almost identical to the 533, is provided.

407 Accounting Machine (Figure 4). This unit combines two machines on one base. The read unit has a maximum input rate of 150 cards (12,000 digits) per minute. The printing unit has a maximum output rate of 150 lines (18,000 characters) per minute. A control panel is provided to allow flexibility of card format during input, and line format during output. The 407 can be disconnected from the system for independent operation.

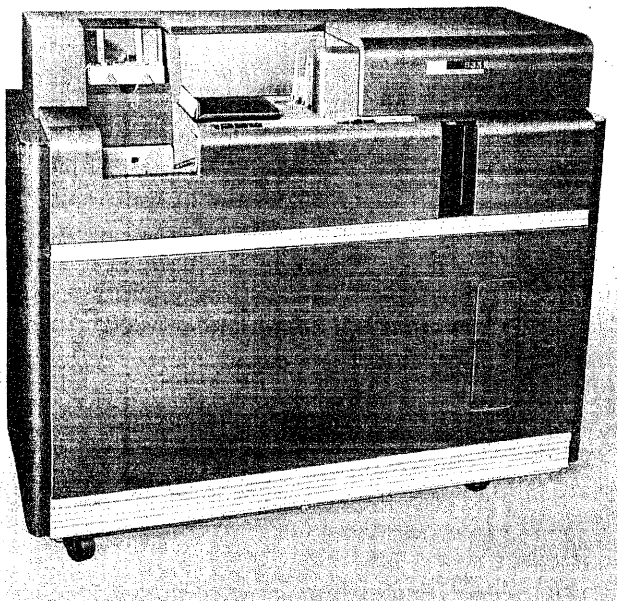

Figure 2. 533 Card Read Punch

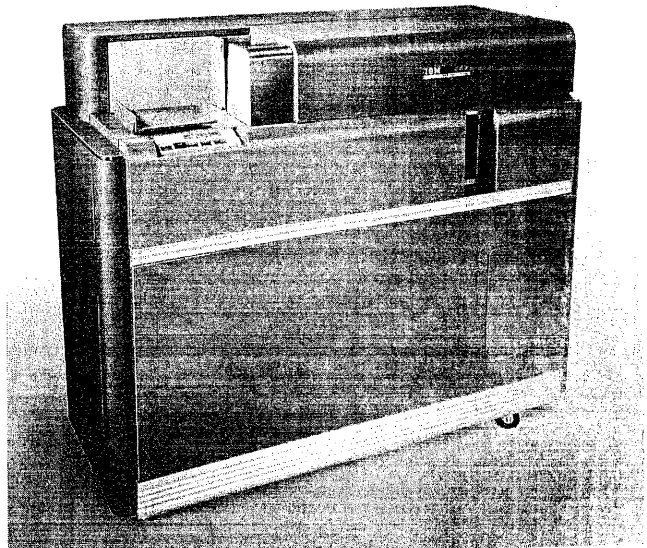

Figure 3. 537 Card Read Punch

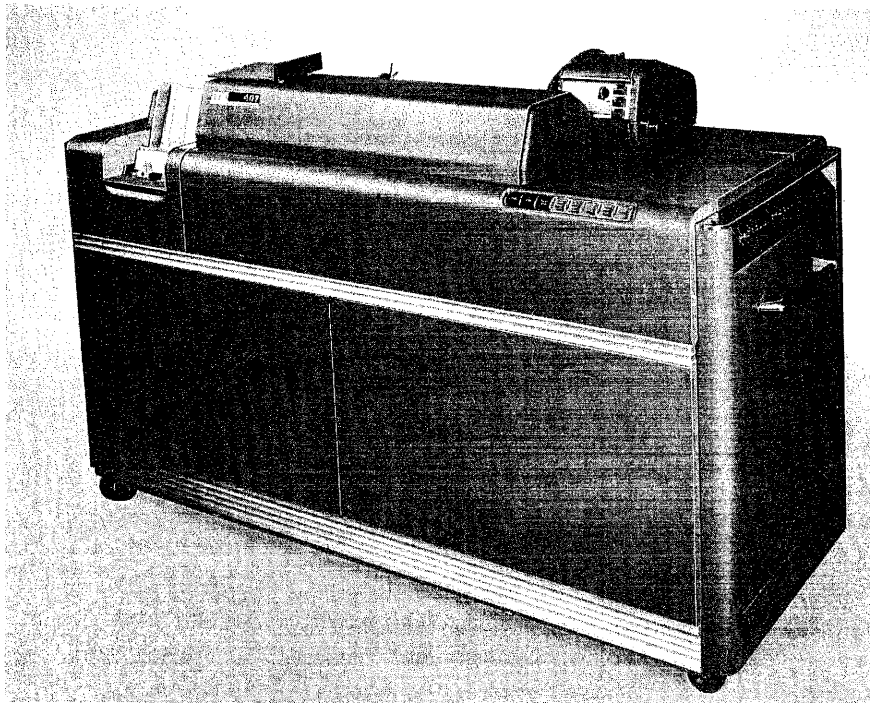

Figure 4. 407 Accounting Machine

Synchronizers. Input-output synchronizers are provided to achieve maximum efficiency within the electronic portions of the system. They couple the mechanical input-output devices to the storage block of the system so that data is transferred between these blocks in a minimum time. The synchronizers also act as language translators: translating the language of the input device to that of the 650, and the language of the 650 to that of the output device. The 650 system can have up to three input-output synchronizers. Each of these synchronizers can accommodate any of the three input-output devices (533-537-407). In this way, up to three input-output devices, in any combination, can be attached to the system. The operation of these synchronizers is covered in detail in the bulletin on Input-Output Operation Codes (Form G24-5002).

Storage

Magnetic Drum. This unit housed in the 650 Console (Figure 5), is the general storage area of the system. It provides storage for 20,000 digits of information.

Within the 650, information is handled in groups of digits called *words*. Each word consists of ten digits and an algebraic sign. The 20,000 digits of storage are more commonly referred to as 2,000 words, and the drum is divided into 2,000 word-locations.

It is necessary to have a means of locating each specific word in general storage at any time. To make this possible, each of the 2,000 word-locations is assigned a 4-digit number (address). These numbers range

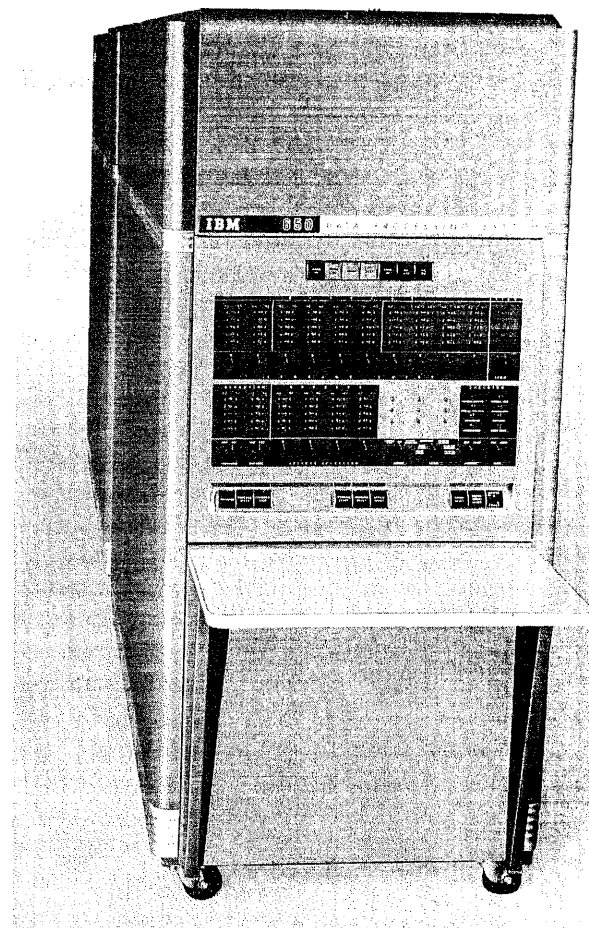

Figure 5. 650-655 Console and Power Unit

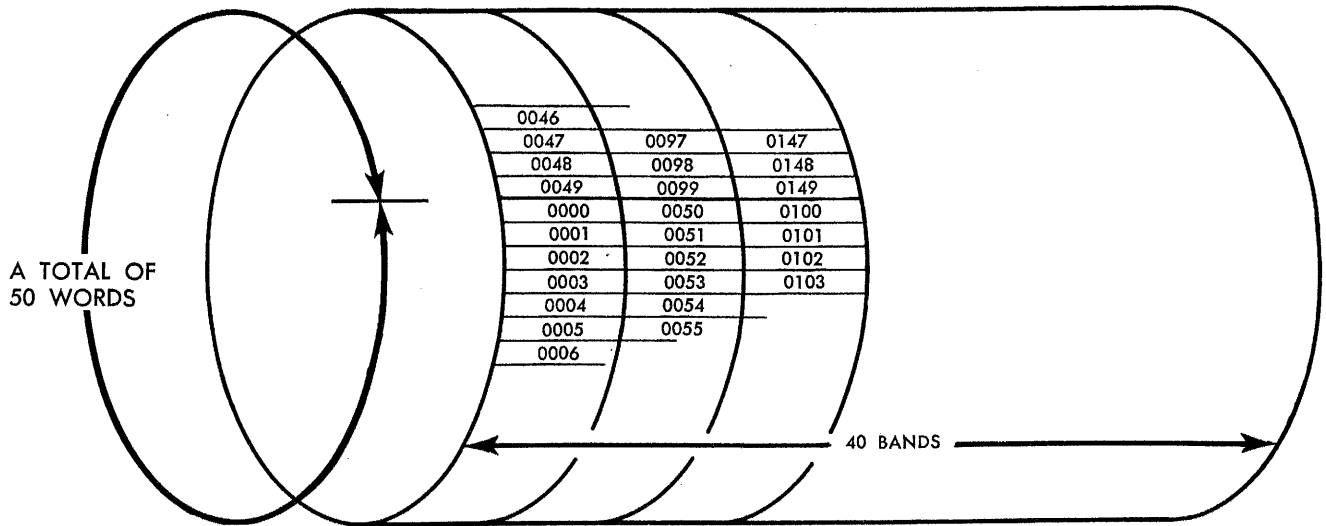

Figure 6. Magnetic Drum Storage Location Layout

from 0000 to 1999. Thus, each word-location has a unique 4-digit address that is used to locate that word only. Any word can be used to store either data or instructions.

The magnetic drum is divided into 40 circular *bands* of general storage. Each band contains 50 words (Figure 6).

Information is stored on the surface of the drum in the form of magnetic spots. Each digit is identified by a specific, recognizable pattern of these magnetic spots. The spots are permanent and will remain until erased by recording new information in the same location. Reading information from the drum has no effect on its permanency. Also, during any normal power shutdown, there will be no loss of information from the drum. This permanency of information is a characteristic of all magnetic storage devices used in the 650.

The drum rotates past a group of stationary heads (one set for each band) that are used for reading and writing the magnetic spots. The time it takes one word-location to pass these heads is called a *word-time*. This is the basic timing unit in the 650. Each drum revolution equals 50 word-times. The maximum time it takes the 650 to locate any word in general storage is 50 word-times. The average time it takes to locate any word is 25 word-times (*average access time*). Programming techniques (*optimum programming*) can reduce the access time to one word-time.

Because the 650 drum rotates at 12,500 rpm, one revolution takes 4.8 milliseconds (1 millisecond equals 1/1000 of a second). Therefore the maximum access time is 4.8 milliseconds (ms). The average access time is 2.4 ms, and one word-time is .096 ms.

Program Register. This is an electronic storage unit with a capacity of 1 word (10 digits). It acts as tem-

porary storage for each instruction of the program as it is being analyzed and executed. It forms part of the control block of the system. Because this is an electronic storage unit, it will *not* retain its information when the power is shut off. However, as long as the power remains on, it will retain its information until new information is read into it. This is true of any electronic storage unit used in the 650.

Distributor. This is an electronic storage unit with a capacity of 1 word (10 digits and an algebraic sign). It forms part of the process block of the system. It acts as temporary storage for data used in arithmetic operations. A complete description of its use is given in the 650 Machine Bulletin, Form G24-5002. This unit, like the program register, will not retain information with the power off. The address of this unit is 8001.

Accumulator. This is an electronic storage unit with a capacity of two words (20 digits and an algebraic sign). It forms part of the process block of the system. This unit acts as temporary storage for the results of arithmetic operations. Shifting information, either right or left, is also done here. Because results of arithmetic operations can be as large as 20 digits, and the machine handles information in groups of 10 digits, the accumulator is divided into two halves (Figure 7), called *lower accumulator* and *upper accumulator*. The lower accumulator has an address of 8002. The upper accumulator has an address of 8003.

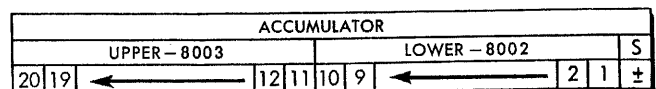

Figure 7. Accumulator

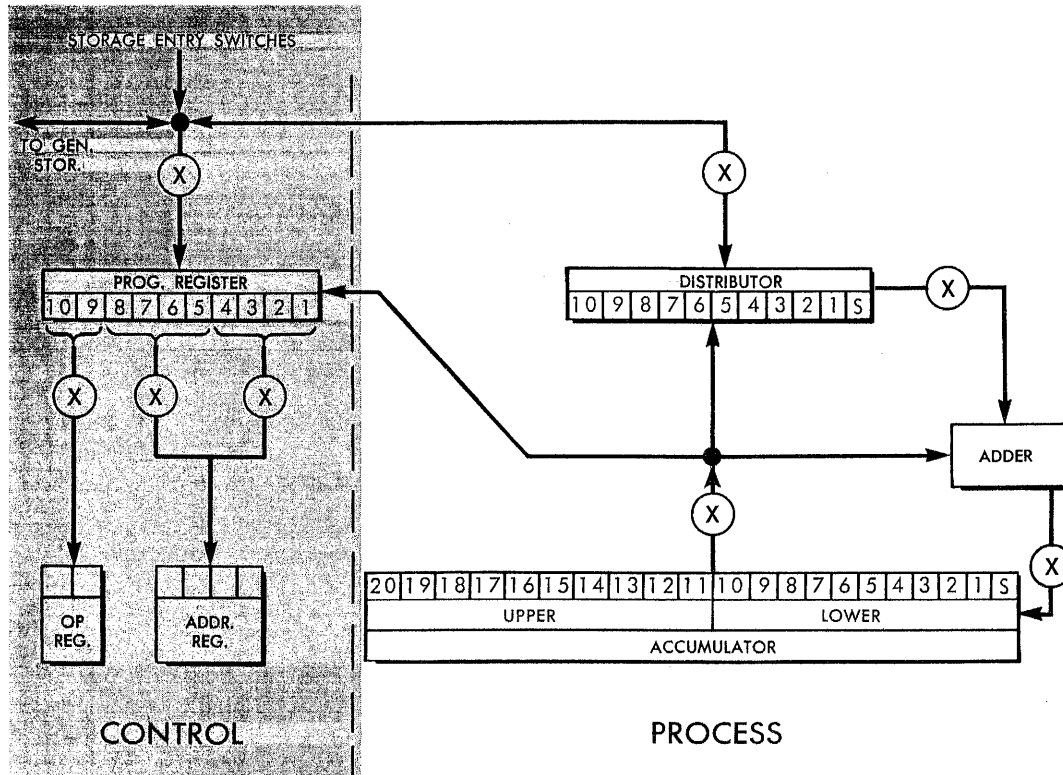

Figure 8. Process Block

Storage Entry Switches. This is a manual storage unit located on the control console. It has a capacity of 10 digits and an algebraic sign. Information is set up in these switches by the machine operator. In this way information can be manually entered into the system. The address of these switches is 8000.

Process

The process block of the system consists of three units: accumulator, distributor, and adder. These units are interconnected by a series of flow paths (Figure 8). All information entering the accumulator must first pass through the distributor and the adder. Information going from the accumulator to general storage also passes through the distributor. Information going from the accumulator to the program register does not pass through the distributor.

Arithmetic operations are performed by combining the contents of the distributor with the contents of the accumulator, and storing the results back in the accumulator. The arithmetic combination is performed in the adder. All arithmetic operations affect all 20 positions of the accumulator.

The accumulator can be tested for these conditions:

1. contents either plus or minus
2. upper accumulator all zeros

3. entire accumulator all zeros
4. results of arithmetic operations have exceeded the capacity of the accumulator (overflow).

Information can enter the distributor from either half of the accumulator, or from general storage. Information leaving the distributor can go to general storage, program register, or either half of the accumulator. Each of the positions of the distributor can be tested for the presence of an 8 or a 9.

Control

Control of the system is exercised through the stored program, and other automatic and manual control features of the machine. The program is a series of instructions that guide the system in the completion of its job. Because no restrictions are placed on the general-storage location of either data or instructions, each instruction must indicate three things:

1. what operation is to be performed
2. storage location of the data to be used in the operation
3. storage location of the next instruction of the program

An instruction must be coded in the language of the 650. The 650 is a digital machine and uses instructions in numerical form.

OP CODE		DATA ADDRESS				INSTRUCTION ADDRESS				SIGN
10	9	8	7	6	5	4	3	2	1	0

Figure 9. 650 Instruction Grouping

The instruction consists of 10 decimal digits and sign. These 10 digits are divided into three basic groups (Figure 9):

1. The operation code (digit positions 10 and 9) indicates the operation to be performed by the 650.
2. The data address is designated by digit positions 8 through 5. Depending upon the operation code used, the data address can have one of these meanings:
 - a. storage location from which the information is to come
 - b. storage location to which the information is to go
 - c. the number of positions to shift the information in the accumulator
 - d. storage locations to which information is to be transferred from the input device
 - e. storage locations from which information is to be transferred to the output device
 - f. storage locations of an alternate instruction
 - g. storage locations of the beginning of a table
3. The instruction address (digit positions 4 through 1) is normally the storage location of the next instruction in the program.

The sign of the instruction is not used in the analysis and execution. However, it must be present to satisfy other control requirements of the system.

Instructions are normally placed in storage from punched cards in a machine loading operation called a *loading routine*. This uses an input device to transfer the instructions from cards to general storage.

After the program instructions are loaded, data is entered for processing. As the program progresses, each instruction is moved from storage to the program register. The program register acts as temporary storage while the instruction is being analyzed and executed. After one instruction has been completed, the next instruction is moved from storage to the program register. The program register can receive information from general storage, distributor, either half of the accumulator, and the console switches.

Two additional registers are associated with the program register (Figure 10). The operation register receives the *op* code and analyzes it to determine the operation to be performed. The address register receives the address portion of the instruction. The operation and address registers, together, control the

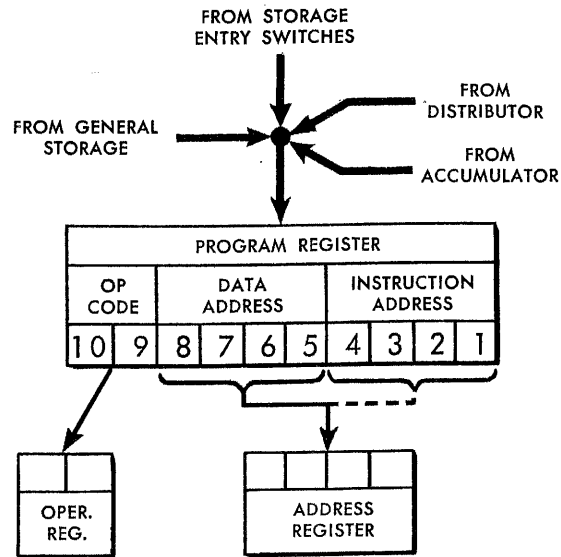

Figure 10. Program Register

execution of the analyzed instruction.

The execution of each instruction is in two steps called *half-cycles*. The half-cycle during which the *op* code and data address are analyzed is called the data (*d*) half-cycle. The half-cycle during which the address of the next instruction is analyzed is called an instruction (*i*) half-cycle.

Beginning with an instruction entering the program register from location 1594 (Figure 11A), the complete sequence of operations for a program step is:

1. Transfer contents of general storage location 1594 to the program register (Figure 11A).
2. Transfer digits 10-5 of the program register to the *op* and address registers (Figure 11B). This is the beginning of the *d* half-cycle.
3. Analyze the part of the instruction now in the *op* and address registers. In this instruction the contents of the *op* register (65) tell the machine to reset the accumulator (all 20 positions) to zero, and then add the contents of some storage location into the lower half. The content of the address register is analyzed to determine from which storage location the data will come.
4. Transfer the contents of general storage location 0025 to the process block of the system where the actual operation will be performed (Figure 11C). The *Control Block* of the system will now monitor the operation until it is completed correctly. While this operation is in progress, the *op* and address registers are released for use during the *i* half-cycle.
5. Reset the *op* and address registers.
6. Transfer digits 4-1 of the program register to the address register (Figure 11D). This is the beginning of the *i* half-cycle.

LOCATION OF INSTRUCTION	INSTRUCTION			OPERATION INSTRUCTION
	OP	DATA	INSTRUCTION	
1593	21	0005	1594	STU
1594	65	0025	1595	RAL
1595	15	0026	1596	ALO

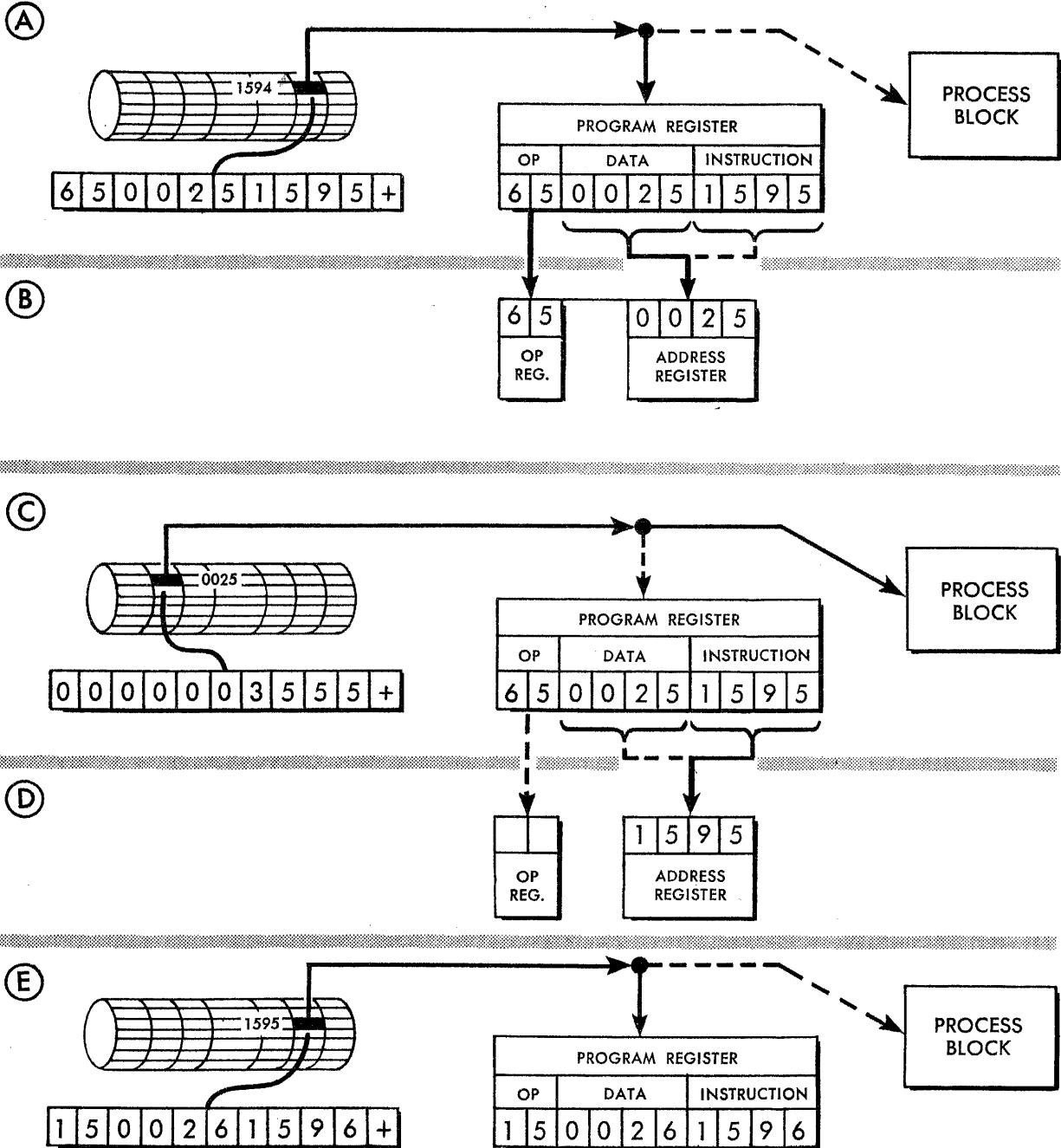

Figure 11. Instruction Execution

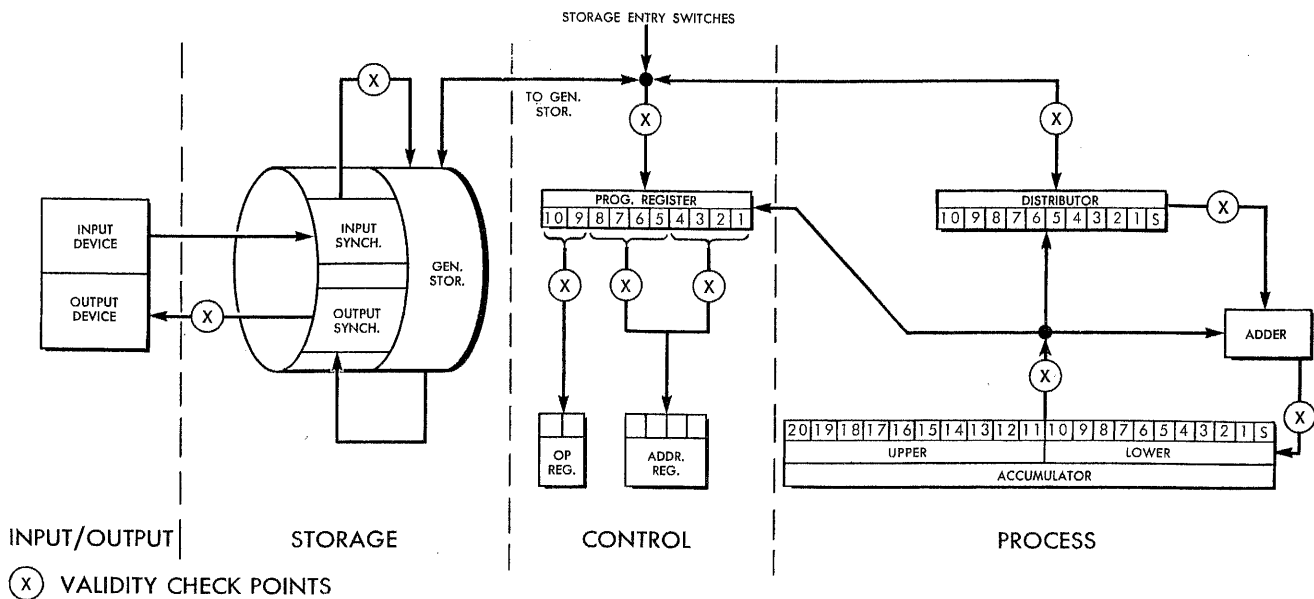

Figure 12. Flow Paths and Validity Check Points

7. Analyze the address register to determine where the next instruction is located (1595).
8. Transfer the contents of general storage location 1595 to the program register (Figure 11E). This completes the cycle. This step is the same as step 1. This new instruction follows the same sequence as the previous one. In this way, the 650 advances from instruction to instruction until the program is completed.

The 650 is so designed that while most operations are being performed by the process block of the system, the next instruction can be located and placed in the program register. Interlocks are provided to prevent one operation from beginning until the previous one is completed. Overlapping the processing with the search for the next instruction contributes to the efficiency of the electronic portions of the system. This is made possible by the flow-path arrangement used to connect the various blocks of the system (Figure 12). With this interconnection of blocks it is possible to carry on four operations simultaneously:

1. input
2. output
3. processing
4. search for next instruction

A control console is provided so the operator can monitor and modify the program as it progresses. All areas of the control block of the system have indicating

lights on this console. A complete description of the console with its lights and switches is covered in the Console Operation Section.

Figure 13 illustrates the various steps of a generalized 650 problem from its inception to the answer punched in a card.

Checking Features

The 650 has been designed with a high degree of reliability. In addition to this reliability, the 650 system has many internal, automatic-checking features. The basic philosophy of these checks is that *nothing is taken for granted*.

All functions and data in the machine are represented by the presence of electronic signals, never by the absence of a signal.

However, an internal automatic-checking feature of any machine can not be a substitute for adequate accounting-control checks. These control checks are applied to the job, both before and after the system has processed the data, to assure that the results are accurate.

Bi-Quinary Codes

The internal processing language of the 650 is in the form of a bi-quinary code. The use of this code makes possible part of the self-checking features of the 650 system.

GENERALIZED 650 DATA FLOW

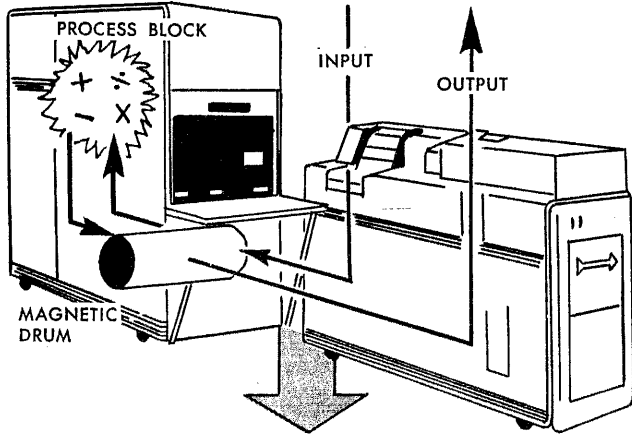

DEFINE THE PROBLEM

$$A + B = C$$

WRITE THE PROGRAM



	INSTRUCTION	OP CODE	DATA ADDRESS	ADDR. NEXT INSTR.	
0001	READ A CARD	70	0059	0002	
0002	RESET ADD LOWER	65	0059	0003	+ A
0003	ADD LOWER WITHOUT RESET	15	0060	0004	+ B
0004	STORE ACCUMULATOR	20	0077	0005	= C
0005	PUNCH A CARD	71	0077	0001	

THE INSTRUCTIONS ARE PUNCHED IN CARDS

LOAD THE PROGRAM

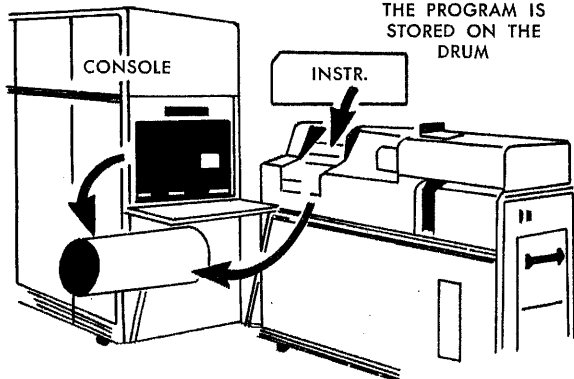

THE FIRST INSTRUCTION FEEDS A DATA CARD

READ A CARD	70	0059	0002
-------------	----	------	------

READING STATION

. . AND STORES THE DATA ON THE DRUM

STORAGE ENTRY

PROCESS THE DATA

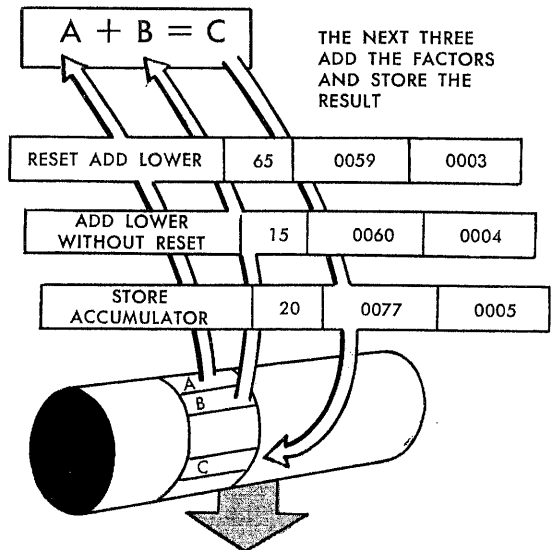

PUNCH THE RESULTS

PUNCH A CARD	71	0077	0001
--------------	----	------	------

PUNCHING STATION

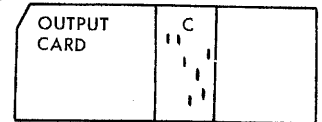

Figure 13. Generalized 650 Data Flow

The bi-quinary code uses seven possible units of information. Two of these units (bits) are known as the binary portion of the code. They are assigned the values of B0 (zero) and B5. The remaining five units are known as the quinary portion of the code and have the assigned values of Q0 (zero) Q1, Q2, Q3, and Q4 (Figure 14).

When this code is used, each digit (0-9) is represented by a specific combination of *one binary bit* and *one quinary bit* (Figure 14). Because this arrangement provides for only 10 possible combinations, it is used as a means of checking for valid information. This is known as a *validity check*.

Validity Checks

The use of the bi-quinary code in the IBM 650 provides a unique method of checking the internal transmission of information. Because each digit (0-9) is represented by one *and only one* binary bit and one *and only one* quinary bit, an invalid digit can be detected by checking for lost or gained bits. Validity-checking errors are indicated by any of these conditions:

1. no binary bit
2. two binary bits
3. no quinary bit
4. more than one quinary bit
5. no binary and no quinary bits (blank)

Validity-checking occurs constantly as data is transferred within the 650. The validity-check points are located at positions shown in Figure 12. As a result:

1. All information in the distributor, accumulator, and program register is validity-checked. This method assures that only valid information is processed by the 650 system, and that no digits have been affected by the failure of the transmitting elements. In addition, incorrect answers, but with valid bit-coding (such as $2 + 2 = 5$) are prevented by the logic design of the adder circuits.
2. Information is validity-checked as it is being transferred to general storage from the input synchronizer areas. This check detects failures that may have occurred during card reading. This check can be made inoperative by control-panel wiring on the input device (533, 537, 407). Some of the failures detected and their results are:
 - a. Failure to read a column for any reason causes a blank position (no bits).
 - b. Shorted reading brushes cause extra bits to be added to the associated digit positions
 - c. Early, late, or crooked card-feeding can cause blank digit positions by failing to read a

punched hole, or extra bits in a digit position by reading punched holes in adjacent columns.

3. Information is validity-checked as it is being transferred from the output synchronizer areas to the output device. This check insures valid information is transferred from the output synchronizer to the output device. This check can be made inoperative by control-panel wiring in the output device.

To receive the full benefit of validity-checking, 12-punches must be used for positive signs. If these are not used, the machine assumes that the absence of an

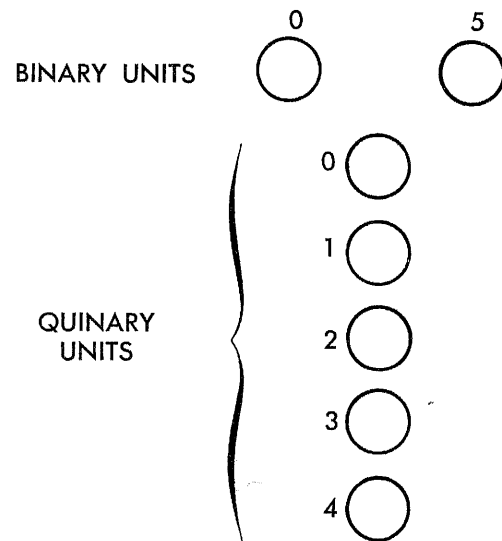

Bi-Quinary Representation

DIGIT	BINARY	QUINARY
0	0	0
1	0	1
2	0	2
3	0	3
4	0	4
5	5	0
6	5	1
7	5	2
8	5	3
9	5	4

Bi-Quinary Code

Figure 14. Bi-Quinary

11-punch means a positive sign (this is under the control of control-panel wiring). Then the failure to read an existing 11-punch would cause the machine to assume that the factor is positive.

Additional output checking is accomplished by the double-punch and blank-column detection device. This device detects the failure to punch or the presence of multiple punches in any numerical column.

Control Checks

Another system of checking called *control checks* has been incorporated into the 650. Two of these checks are used in the program-register unit to detect these

conditions:

1. the presence of operation codes other than those assigned for machine functions
2. the presence of data or instruction addresses that are other than valid machine addresses. (Valid addresses are 0000-1999, 8000, 8001, 8002, 8003. The addition of magnetic tape units, immediate access storage, etc., expands the range of valid addresses.) Other control checks are built into the machine to determine any timing discrepancies or accumulator overflows not anticipated in problem processing. A further discussion of these checks is included in the Console Operation Section.

Console Operation

Power Control (Figure 15-1)

Starting the Machine

Pressing the power-on button results in:

1. AC power supplied to the entire machine
2. the blower and drum-drive motors started
3. the power-on light lighted
4. DC power automatically supplied after approximately a three-minute warm-up period
5. the ready light lighted when the DC power is supplied.

NOTE: The power-on button must be held depressed until the power-on light comes on.

Temporary DC Off

Pressing the DC-OFF button removes only the DC power from the machine and causes the ready light to go out. This permits the 650 to be shut down for short periods (about an hour) without cooling and reheating the electronic components of the machine. DC power is restored by pressing the DC-ON button. When the DC power has been fully restored, the ready light turns on.

Shutting Down the Machine

Pressing the power-off button will remove all power from the machine in the following sequence:

1. DC power is turned off.
2. The ready and power-on lights go out.
3. AC power (except that supplied to the blower motors) is turned off.
4. The blower motors are automatically turned off after a period of five minutes.

NOTE: The master power switch (Figure 15-8) should be used only in emergencies. It immediately removes all power from the machine including the blower motors. If this switch is tripped, the services of a customer engineer are required before the 650 can be put back in operation.

If a fuse blows in the 650-655, the DC is automatically removed and the fuse light (Figure 15-1) comes on.

Displaying Information

Display Lights (Figure 15-2)

These lights are used to display visually any word of information from within the machine. Each digit position is represented by seven lights. The horizontal pairs of lights are known as binary lights and represent the values 0 and 5. The five vertical lights are known as quinary lights, and represent values of 0, 1, 2, 3, 4, or 5, 6, 7, 8, 9, depending upon which binary light is on. The sign of the word is indicated by one of the two sign lights on the extreme right, as illustrated in this sample digital representation of the number 0375+.

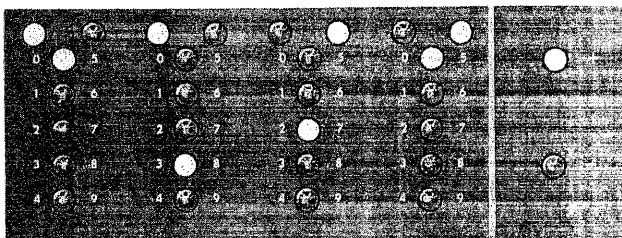

Display Switch (Figure 15-8)

This switch is used to select which unit (program register, distributor, upper accumulator, or lower accumulator) is to be displayed in the display lights. It has a further use in conjunction with the control switch, for manually displaying the contents of any drum location, or manually entering information into any drum location. (On systems equipped with Immediate Access Storage, these functions are expanded to include this unit.)

Operation and Address Lights (Figure 15-4)

These lights indicate the contents of the operation and address registers. The operation lights indicate the operation to be performed during the 0 half-cycle. They are blank during the 1 half-cycle. The address

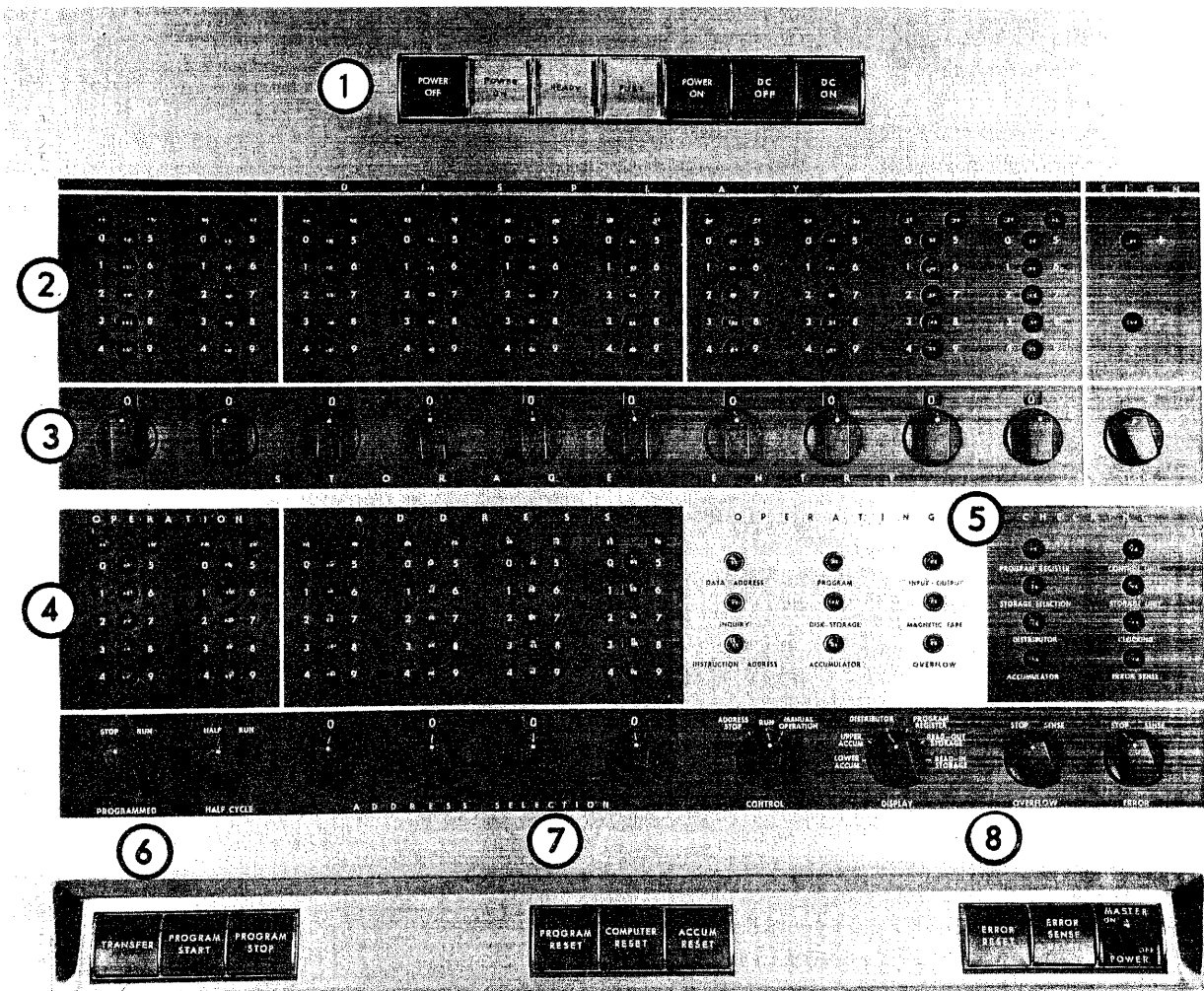

Figure 15. Control Console

lights indicate the *d*-address if the data-address light (Figure 15-5) is on. They indicate the *i*-address if the instruction-address light (Figure 15-5) is on.

Displaying Accumulator, Distributor or Program Register

The contents of any one of these units can be displayed in the display lights whenever the execution of the program is stopped. The unit to be displayed is selected by the display switch.

Displaying General Storage

Any drum (or core) storage location can be displayed as follows:

1. Stop the program.

2. Set the address switches (Figure 15-7) to the address of the storage location to be displayed.
3. Set the control switch (Figure 15-8) to the MANUAL OPERATION position.
4. Set the display switch to the read-out storage position.
5. Press the program reset key (Figure 15-7). This sets the operation and address registers to blanks.
6. Press the transfer key (Figure 15-6). This transfers the setting of the address switches to the address register.
7. Press the program start key (Figure 15-6). This causes the contents of the selected storage location to be displayed in the display lights. This display is being viewed through the distributor. This causes the previous contents of the distributor to be lost.

Entering Information

Information can be entered into the system manually as follows:

To Drum

1. Stop the program.
2. Set up the information to be entered in the storage entry switches (Figure 15-3).
3. Set the address of the drum location to be entered in the address selection switches.
4. Set the control switch to manual.
5. Set the display switch to read-in storage.
6. Press the program reset key.
7. Press the transfer key.
8. Press the program start key.

Information set up in the storage-entry switches is entered into the location specified by the address selection switches. The information also appears in the display lights because it passes through the distributor on its way to the drum. To verify that the entry was completed correctly, the information should be read out of storage using this procedure:

1. Move the display switch from read-in storage to read-out storage.
2. Press the program reset key.
3. Press the transfer key.
4. Press the program start key.

To Distributor

Information from the storage-entry switches cannot be directly entered into the distributor using 8001 in the address selection switches. If it is desired to enter information into the distributor manually, an unused drum location must be selected and the read-in storage procedure used.

To Accumulator

Information from the storage-entry switches cannot be directly entered into either half of the accumulator using the 8002 or 8003 in the address selection switches. To enter information into the accumulator manually requires two steps:

METHOD I

1. Enter the desired information into some unused drum location, which will also place it in the distributor.
2. The contents of the distributor can then be added to, or subtracted from, the accumulator as follows:
 - a. Set up the add or subtract instruction in the storage-entry switches. (Use 8001 for D-address.)
 - b. Set the control switch to RUN.
 - c. Press the program reset key. This will enter 8000, the address of the storage-entry switches, into the address register.

- d. Set half-cycle switch to HALF.
- e. Press the program start key.

METHOD II

1. Set up the add or subtract instruction, with a D-address of 8000, in the storage-entry switches.
2. Set the control switch to RUN.
3. Set the half-cycle switch to HALF.
4. Press the program start key.
5. Set up the desired factor in storage-entry switches.
6. Press the program start key.

Starting the Program

Two methods are commonly used to start the program:

Method I — First Instruction in Storage-Entry Switches

1. Set 00 0000 xxxx in the storage-entry switches (where xxxx is the address of the first instruction to be executed).
2. Set the control switch either to RUN or ADDRESS STOP (see *Address Stop*).
3. Press the program reset or computer reset key. (This places 8000 in the address register.)
4. Press the program start key.

This procedure causes the 650 to get its first instruction from the storage-entry switches. This instruction calls for no operation, and its I-address is the address of the first instruction of the program.

NOTE: The instruction set up in the switches could be an actual instruction. In this way, the switches are an active location in the program.

Method II — First Instruction in Address Register

1. Set the control switch to MANUAL.
2. Set up the address of the first instruction to be executed in the address selection switches.
3. Press the program reset or computer reset key.
4. Press the transfer key.
5. Set the control switch to RUN or ADDRESS STOP.
6. Press the program start key.

This procedure will cause the 650 to get its first instruction from the location set up in the address selection switches. The foregoing procedures are based on the assumption that other setup procedures, such as input-output devices necessary for proper operation, have been performed.

Controlled Stopping

Program execution of the 650 can be halted on a controlled basis. This control can be exercised by the operator and programmer by various console switch settings. The use of these stops will facilitate program debugging and checking.

Manual Stop

Pressing the program stop key will halt program execution at the end of the D or I half-cycle during which it is pressed. The program can be restarted with the program start key.

Address Stop

This feature is used to halt program execution at any desired program step.

1. Set the control switch to ADDRESS STOP.
2. Set up the address of the desired stop point in the address selection switches.
3. Press the program start key.

Program execution proceeds until the address in the address register equals the value set up in the address selection switches. At this point, program execution is halted. This type of stop can occur on both D- and I-addresses.

To restart the program from the point where the stop took place, press the program start key. Program execution continues until the address stop condition is again satisfied.

Programmed Stop

This type of stop is under program and console control. The program control is exercised by the halt code (01 HLT). The console control is exercised by the programmed switch (Figure 15-6). With the switch set at STOP, program execution is halted whenever a 01 HLT code is encountered. With the switch set at RUN the 01 HLT code is treated as a 00 NOP code and no stop takes place. Thus, for testing purposes, 01 HLT instructions may be inserted at critical points in the program to permit examination of partial results. After the program is proven, these stops can be ignored.

Half Cycling

The half-cycle feature is an excellent aid for checking programs. With this feature each individual D and I half-cycle of any instruction or group of instructions can be examined. Used in conjunction with other console controls, the results of any operation can be checked, both before and after execution. For example, assume that the instructions are part of a larger program, and it is suspected this section is in error (Figure 16):

Location of Instruction	Instruction		
	OP	Data	Instruction
0404	21	0085	0738
0738	65	0093	0510
0510	10	0004	0612
0612	30	0004	0631
0631	XX	XXXX	XXXX

Figure 16. Sample Program

To examine this section of the program on a half-cycle basis, the program is started with the control switch set to ADDRESS STOP and 0738 set up in the address selection switches. The program proceeds until 0738 enters the address register, where the program is halted. Operation is then shifted to half-cycle.

Figure 17 shows the console at the time the address stop occurs.

The program register contains 21 0085 0738. When the instruction-address light is on, the next half-cycle is an I half-cycle, during which the next instruction is located and transferred to the program register.

To set up the machine for half-cycle operation, the half-cycle switch is moved to HALF. To have the machine perform the I half-cycle, the program start key is

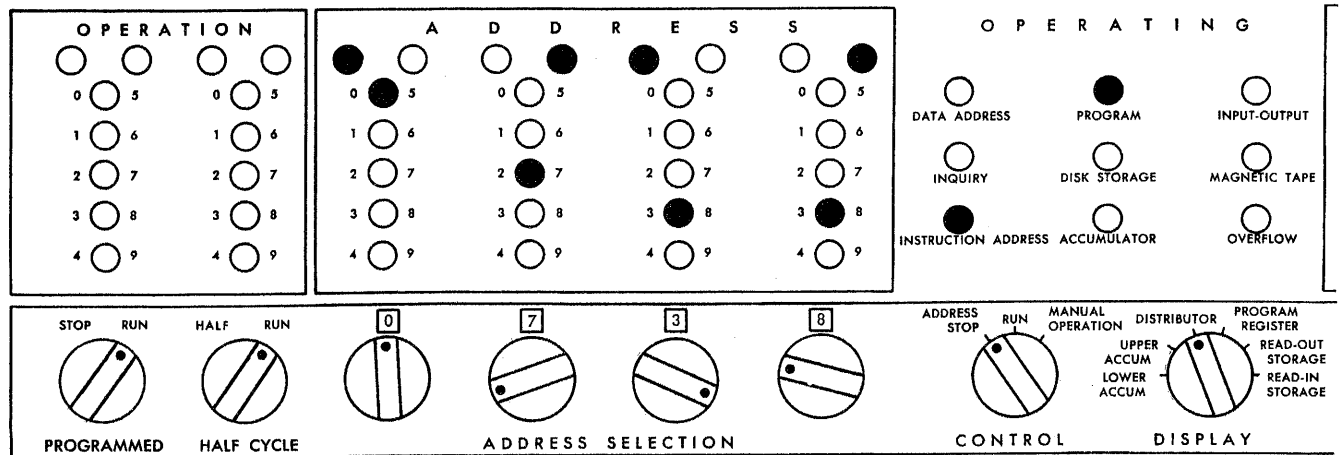

Figure 17

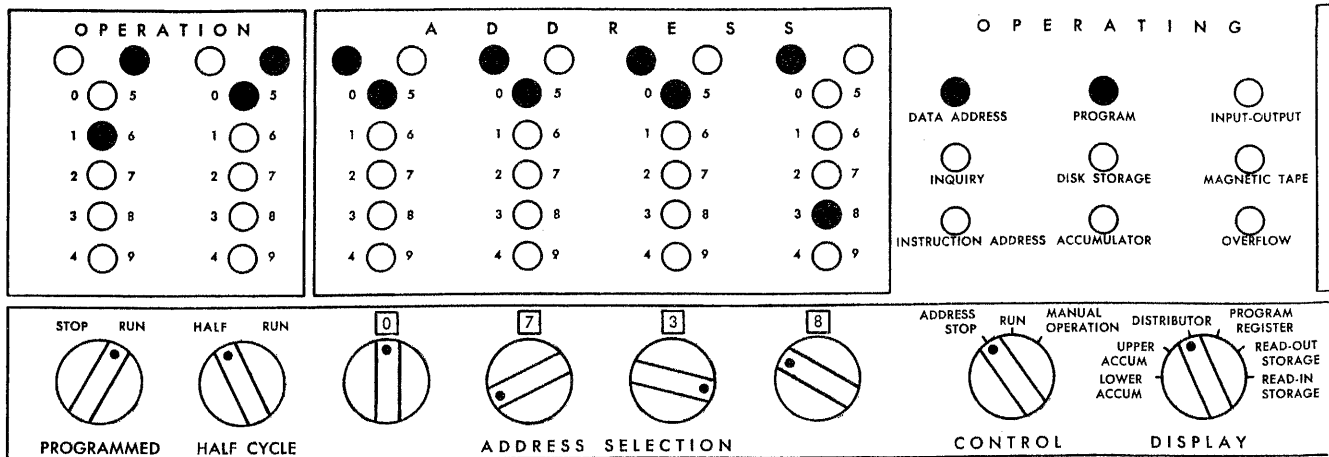

Figure 18

pressed. Figure 18 shows the console at the end of the 1 half-cycle.

The program register now contains 65 0003 0510. The contents of the accumulator, distributor, and program register can be displayed, using the display switch. The data-address light indicates that the next half-cycle will be a *n* half-cycle, during which the accumulator is reset, and the contents of drum location 0003 is added into the lower accumulator.

This half-cycle operation is initiated by another depression of the program start key. Figure 19 shows the console at the end of the *n* half-cycle.

The contents of the program register should be the same as at the end of the previous half-cycle. The distributor and lower accumulator should contain the same factor as location 0003. The upper accumulator should contain all zeros.

Pressing the program start key initiates the next

1 half-cycle, which results in 10 0004 0612 being placed in the program register. Figure 20 shows the console at the end of this 1 half-cycle.

The display switch can not be used to examine the contents of the program register to assure that it agrees with the program sheet.

Pressing the program start key at this point results in the execution of the *n* half-cycle. During this half-cycle, the contents of drum location 0004 is added into the upper half of the accumulator. Figure 21 shows the console at the end of this *n* half-cycle.

The display switch can now be used to examine the accumulator and distributor to assure that the desired results have been obtained.

Pressing the program start key at this point results in the execution of an 1 half-cycle. At the completion of this half-cycle, the program register should contain 30 0004 0631 (Figure 22).

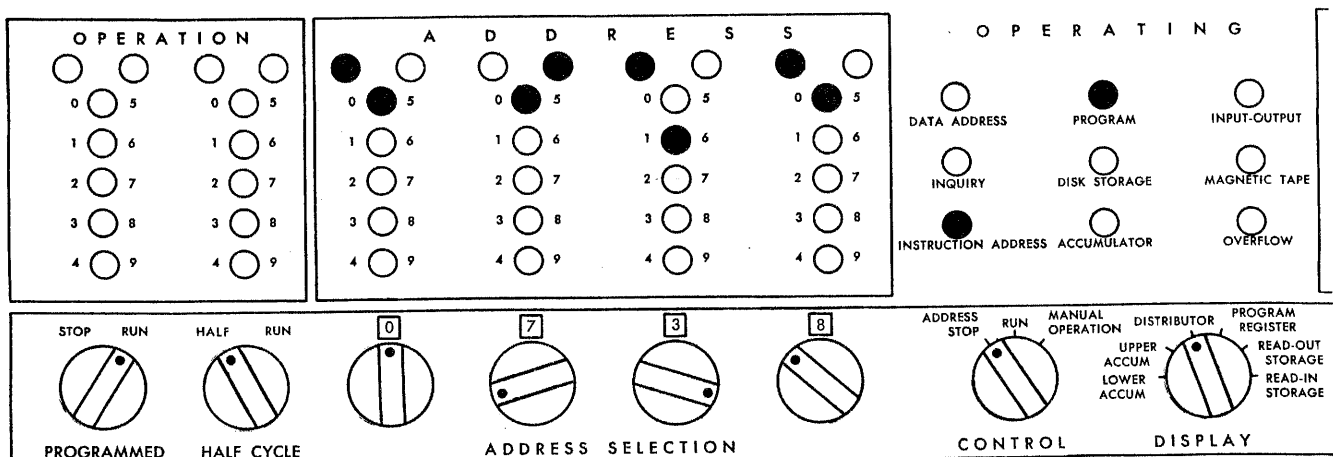

Figure 19

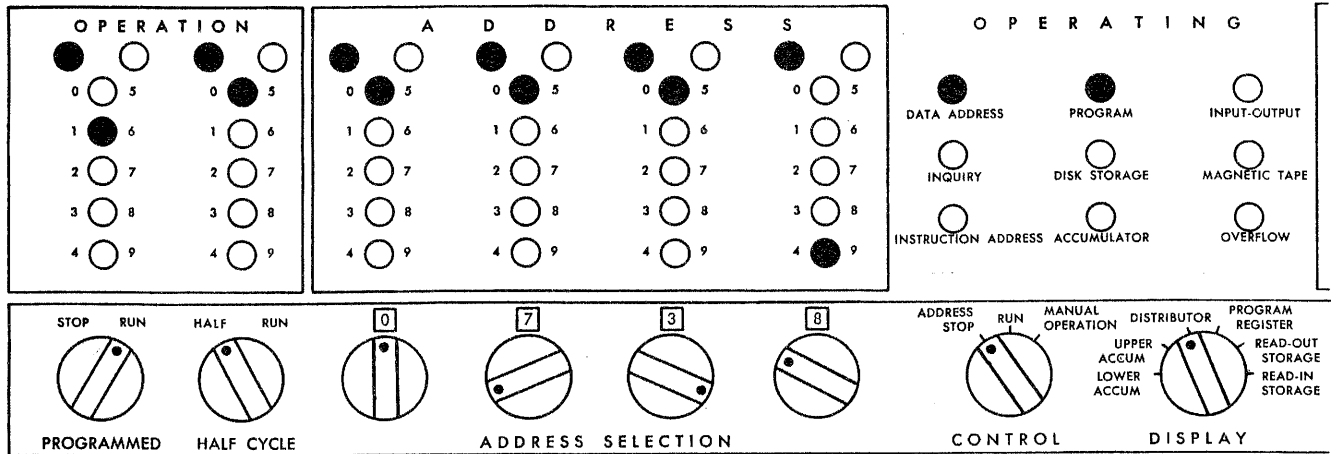

Figure 20

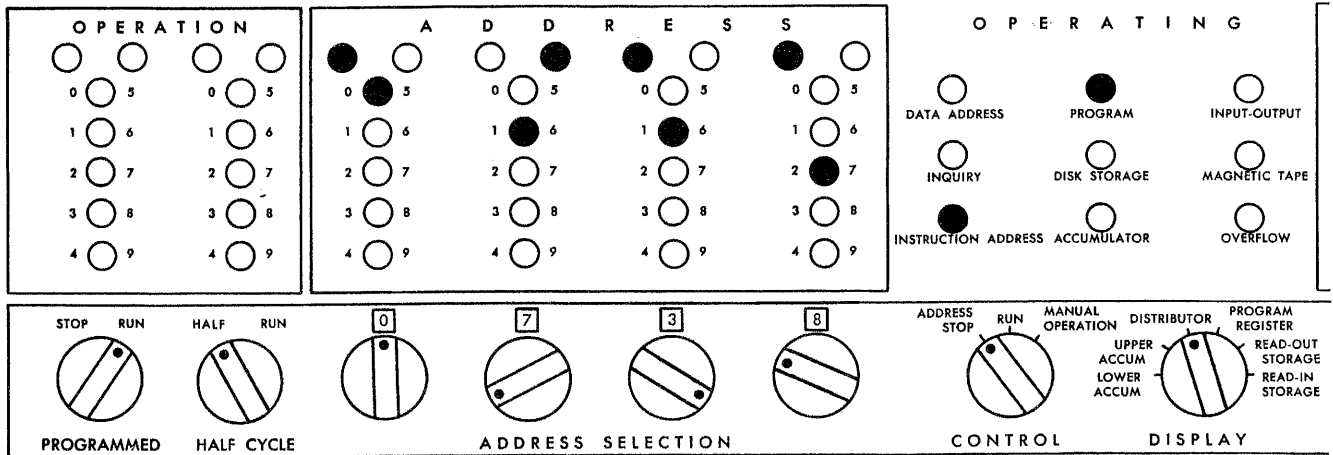

Figure 21

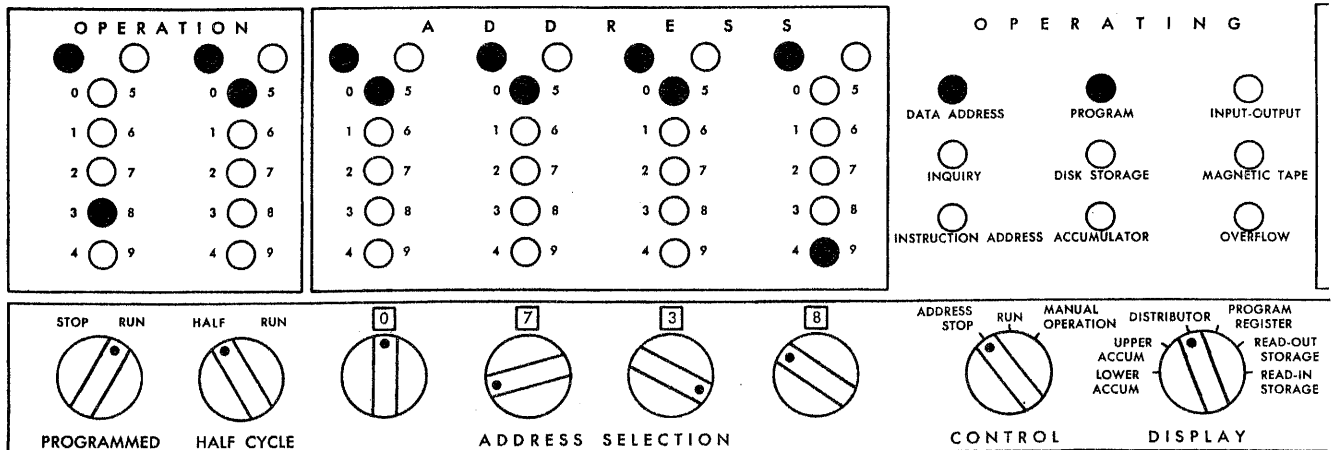

Figure 22

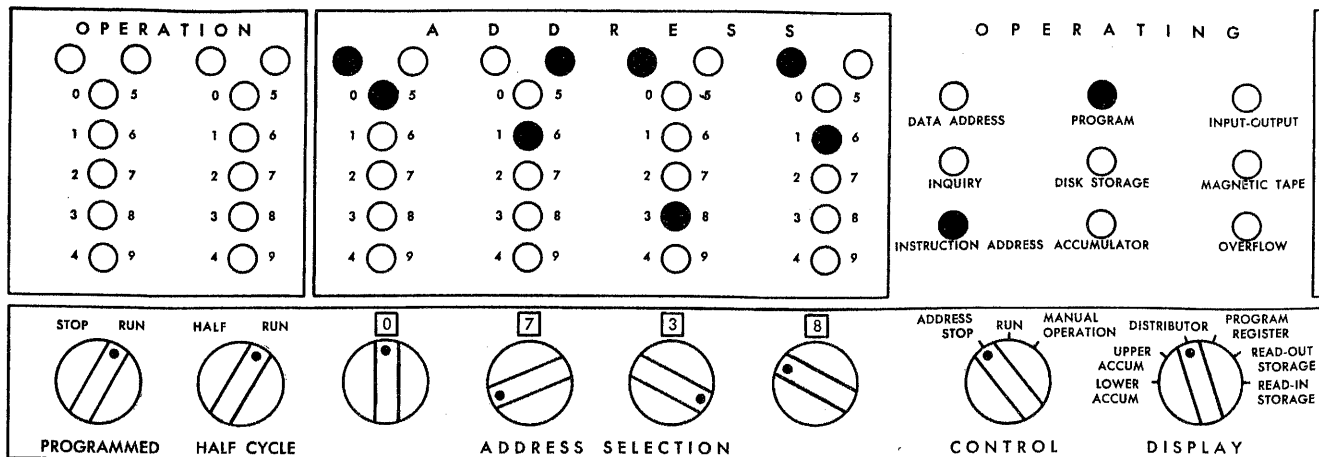

Figure 23

Pressing the program start key at this point results in the execution of a *D* half-cycle. During this half-cycle, the contents of the accumulator are shifted right, four positions (Figure 23).

The display switch can now be used to examine the contents of the accumulator to assure that the operation was completed correctly. If this section of the program proves to be correct, the address selection switches can be set to the address of the next desired stop point, the half-cycle switch set to *RUN*, and the program start key pressed.

Operating Lights (Figure 15-5)

These lights indicate the operating status of the system. They can be very helpful in determining the reason for unscheduled machine stops.

Data Address. With program execution stopped, this light indicates that the next half-cycle will be a *D* half-cycle.

Instruction Address. With program execution stopped, this light indicates that the next half-cycle will be an *I* half-cycle. This light will come on as a result of pressing either the computer reset or program reset key with the control switch set to *RUN* or *ADDRESS STOP*.

Program. This light is on only if program execution is stopped:

1. manually
2. by a programmed stop
3. by an address stop

However, it does not come on if a manual stop takes place during the *I* half-cycle of an input-output command.

Accumulator. This light is on whenever the accumulator is in use.

Input-Output. This light is on during the *D* half-cycle of any input-output instruction (70, 71, 73, 74, 76, 77). It stays on until the interlock is removed. If program execution is stopped with this light on, it may indicate one of the following conditions:

1. No cards in one of the feed hoppers
2. A feed failure
3. Cards have not been run into one of the feeds
4. The stop key on one of the input-output units has been pressed
5. An *rvc* (Read Validity Check) or *pvc* (Punch Validity Check) has occurred. This is further signified by the storage selection light (Figure 15-5) and a valid address showing in the address lights.
6. Using an input-output code for a unit that is not attached
7. Trying to execute an output code on a unit that has a *DPBC* error.

Overflow. This light comes on if an overflow condition occurs. An overflow condition can be caused by one of the following:

1. An excessive accumulation
2. Trying to develop a quotient of more than ten digits
3. Trying to exceed the number of shifts called for in a shift-and-count operation.

Inquiry; Disk Storage; Magnetic Tape. The function of the magnetic-tape light is covered in 650 Machine Bulletin, Form G24-5003. The function of inquiry and disk storage is covered in the 650 RAMAC® Manual of Operation, Form 22-6270.

Checking Lights (Figure 15-5)

These lights are used to indicate the presence of an error condition in the various units of the system.

Program Register. Indicates the detection of a validity error in the program register.

Storage Selection. Can indicate any one of the following error conditions:

1. An RVC or PVC error. If this type of error is detected, the input-output light is on, and a valid address appears in the address lights
2. An instruction with an invalid D- or I-address
3. Information being written in two or more drum locations simultaneously
4. Information not being written in any drum location on a store operation
5. A store operation with a D-address in the 8000 series
6. Attempted manual entry to 800X from the storage-entry switches
7. Not finding an equal or higher value on a TLU operation.

Distributor. Indicates the detection of a validity error in the distributor.

Accumulator. Indicates the detection of a validity error in the accumulator.

Clocking. Indicates the detection of an error in the timing circuitry.

Error Sense. Operates in conjunction with the error switch (Figure 15-8). When this switch is set to sense, the error sense light comes on for one of these conditions:

1. validity error
2. clocking error

The light remains on until the error sense reset switch (Figure 15-8) is pressed.

Control Unit — Storage Unit. The operation of these lights is covered in a later 650 Bulletin, Form G24-5003.

Error Sensing and Stopping

Inherent in the design of the 650 System is a series of checks that assure correct processing of data. If an error should occur, it is signaled on the console and can be corrected manually or automatically.

Unconditional Error Stops

Some error conditions, by their nature, are not correctable by automatic machine procedure. Therefore, they always result in stopping program execution. These

errors are:

1. RVC (Read Validity Check)
2. PVC (Punch Validity Check)
3. Invalid address (Storage Selection)
4. Invalid OP Code
5. Divide overflow

Conditional Error Stops

Some other error conditions can, when they occur, cause program execution to stop, or programmed error-correction routines to take place. The error switch (Figure 15-8) controls which two of these possibilities is used. These are under control of the error switch:

1. program register validity error
2. distributor validity error
3. accumulator validity error
4. clocking

With the error switch set to STOP, any of the preceding errors halt program execution. The location of the error is signaled by the corresponding checking light.

With the switch set to SENSE, any of these errors cause program execution to be momentarily stopped while an automatic computer-reset operation is performed. Program execution is then restarted using the storage entry switches (8000) as the location of the first instruction executed after the computer reset.

The automatic computer-reset operation results in the program register, distributor, and accumulator being reset to zero; the operation register is reset to blanks, and the address register is set to 8000. The program control is set so that the first half-cycle executed is an I half-cycle. The error-sense light is left on to indicate that a random error occurred.

The logic of including the error-sense feature in the 650 is that a majority of the errors detected in these four areas are random in nature. Therefore, it is reasonable that they will not recur.

Care must be used when applying the error-sense feature because the contents of the program register, distributor, and accumulator are lost when the error is detected. In practice, very large problems are broken into segments, and it is not necessary for the machine to repeat the whole problem when an error occurs.

The storage entry switches can be set to 00 0000 xxxx, where xxxx is the location of another NOP instruction whose I-address is modified as various segments of the problem are completed successfully.

The preceding statements should not be construed to mean that normal accounting and procedural controls can be eliminated or ignored. Such controls should be embodied in the definition of the problem, and should be regarded as part of the general procedure of efficient programming.

Overflow Sensing and Stopping

In the arithmetic operations of many problems, if the capacity of the accumulator is exceeded (overflow), some error has occurred that may require manual handling. In other problems the overflow indicates that a specific point in the problem has been reached, and that a different branch of the program is to be used.

The effect of an accumulator overflow on machine operation is controlled by the overflow switch (Figure 15-8). When the switch is set at *STOP*, any overflow causes program execution to stop at the end of the *D* half-cycle during which the overflow occurred. The overflow light indicates the cause of the stop. When the switch is set at *SENSE*, any overflow except one caused by improper division, lights the overflow light and sets up an internal overflow condition. This internal overflow condition can be interrogated using the 47 *BOV* (Branch on Overflow) operation code, which also turns out the overflow light. These statements also apply to an overflow set up during the execution of a 36 *SCR* (Shift and Count) operation code.

Control Keys (Figure 15-6, 7, 8)

Transfer. This key functions only when the control switch is set to manual operation. When operative, pressing this key transfers the number set up in the address selection switches to the address register.

Program Start. This key is used to initiate program execution. The starting point is determined by the setting of the program control (*D* or *I*) and the contents of the operation and address registers. It has a further use as described under *Displaying Drum Storage* and *Entering Information*.

Program Stop. This key is used to halt program execution. It stops at the completion of the half-cycle during which the key is pressed.

Program Reset. This key resets the program register to zeros, and sets program control to *I* half-cycle. Also, it resets the error circuits that have been activated by a program register validity check, storage selection error, or a clocking error. Its effect upon the operation and address registers is determined by the setting of the control switch. When the control switch is set on *MANUAL*, both registers receive blanks. With the control switch set at either of the other two positions, the operation register is blanked and the address register receives 8000.

Computer Reset. This key resets all error circuits and sets the program register, distributor, and accumulator to zeros. Also, it sets the program control to *I* half-cycle. Its effect on the operation and address registers is identical to the program reset key.

Accumulator Reset. This key resets the distributor and accumulator to zeros. It also resets error circuits that have been activated by an overflow, accumulator validity-check, distributor validity-check, clocking error, or storage-selection error other than that caused by an invalid address. It has no effect on the contents of the program, operation, and address registers.

Error Reset. This key resets the error circuits activated by a clocking error or a storage selection error other than that caused by an invalid address. It also resets an overflow condition if both the overflow and error switches are set to *STOP*.

Error Sense Reset. This key resets the error-sense circuit and turns out the error-sense light. It is effective only when the error switch is set to *SENSE*.

Special Devices

Alphabetic and Special Character Devices

These devices, available for use with the 533, 537, and 407 are used to convert the punching (numeric, alphabetic, special character) in any *one* column of the input card, into *two* numeric digits within the 650 System. Similarly, the devices convert the *two* numeric digits within the 650 into *one* character for output. These conversions take place as the information is being transferred to and from the input-output units and the synchronizers. The first six-storage entry and exit words

can be used, giving a total capacity of 30 characters input and output.

The basic device is the alphabetic device. The Special-Character Device is an addition to the alphabetic device and can be installed in either one of two options, Group I or Group II. Figure 24 shows all the alphabetic, numerical, and special-character codes as they appear in the card and within the 650, after being converted by the devices. Also shown is the particular device that handles each individual character.

Character	Card Code	650 Code	Handled by *	Character	Card Code	650 Code	Handled by
Blank		0 0	A, B	M	11-4	7 4	A
Period .	12-3-8	1 8	C	N	11-5	7 5	A
Lozenge □	12-4-8	1 9	C	O	11-6	7 6	A
Ampersand &	12	2 0	B, C	P	11-7	7 7	A
Dollar Sign \$	11-3-8	2 8	C	Q	11-8	7 8	A
Asterisk *	11-4-8	2 9	C	R	11-9	7 9	A
Dash -	11	3 0	B, C	S	0-2	8 2	A
Diagonal /	0-1	3 1	C	T	0-3	8 3	A
Comma ,	0-3-8	3 8	C	U	0-4	8 4	A
Per Cent %	0-4-8	3 9	C	V	0-5	8 5	A
Pound #	3-8	4 8	C	W	0-6	8 6	A
At @	4-8	4 9	C	X	0-7	8 7	A
A	12-1	6 1	A	Y	0-8	8 8	A
B	12-2	6 2	A	Z	0-9	8 9	A
C	12-3	6 3	A	0	0	9 0	A
D	12-4	6 4	A	1	1	9 1	A
E	12-5	6 5	A	2	2	9 2	A
F	12-6	6 6	A	3	3	9 3	A
G	12-7	6 7	A	4	4	9 4	A
H	12-8	6 8	A	5	5	9 5	A
I	12-9	6 9	A	6	6	9 6	A
J	11-1	7 1	A	7	7	9 7	A
K	11-2	7 2	A	8	8	9 8	A
L	11-3	7 3	A	9	9	9 9	A

- * A Alphabetic Device
- B Special Character Device, Group I
- C Special Character Device, Group II

Figure 24. Alphabet and Special Character Codes

Because each character is stored within the 650 as two numerical digits, a 650 storage word can handle 5 characters. Thus, if the part number 5A-2R is entered into the 650, it is recoded as 9561309279 + and can be stored in one word. If the part number is 5A7-2R, two words are needed, and the recoding is 0000000095 + 6197309279 +. In each case the word(s) entered, using the device, automatically receive positive signs. The recoded information can be used logically in the program for table-lookup arguments, etc., and is handled internally as any other numeric information.

The device is flexible, using control-panel wiring. Any number of input words from 0 to 6 can be designated as alphabetic by selective control-panel wiring. The words used can vary from card to card. Similarly, any number of output words, from 0 to 6, can be designated as alphabetic, and need not be the same as the input words. Control of output words can be by either internal programming, and/or control-panel wiring.

The principles of control-panel wiring are the same for all three input-output units (533, 537, 407). Therefore, the description of the control-panel hubs is grouped under *Input* and *Output* and is common to all units. A wiring example for each machine is shown.

INPUT

Basically, three things are necessary to accomplish alphabetic input:

1. Indicate, on the input-unit control panel, which of the first six storage-entry words are to be used for alphabetic information.
2. Analyze each card column to determine if it is blank, alphabetic, numerical, or special character. This is done while the card is at the first reading station.
3. Enter the information into storage entry from second reading. It will be recoded on the basis of the analysis that took place at first reading, and the specific punching read at second reading.

Control Panel

The following hubs are associated with the control of alphabetic input. For the 533-537, see Figure 25. For the 407, see Figure 26.

CAI (Constant Alphabetic Impulse). The impulse from this exit is available on every card-feed cycle except load cycles. It is normally used to impulse ALPH IN to determine which of the first six storage-entry words are to be used for entering alphabetic information.

ALPH IN (Alphabetic In). These hubs are entries. When one is impulsed, the corresponding storage-entry word is conditioned to receive and recode alphabetic information.

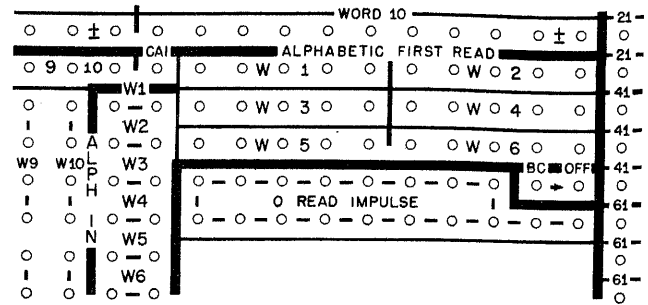

Figure 25. 533-537 Input Control-Panel Hubs—Alphabetic Input

Alphabetic First Read. These entry hubs are normally wired from first reading to analyze card columns for blank, alphabetic, numerical, or special characters. Each group of five hubs is associated with a corresponding storage-entry word. Within a group of five hubs, each hub is associated with the corresponding hub of the storage-entry word. Thus, the right-hand hub of alphabetic first read-W1 is associated with the units position of storage-entry word 1, etc.

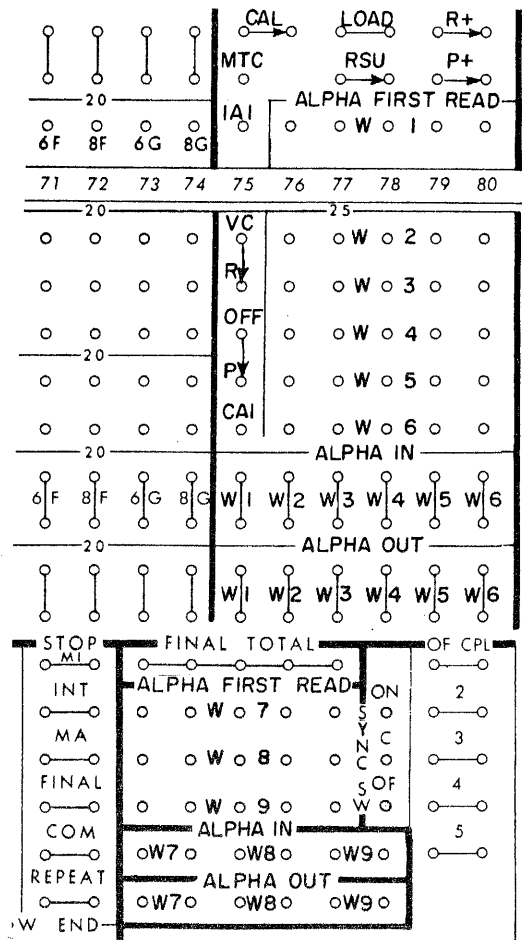

Figure 26. 407 Control-Panel Hubs—Alphabetic Input

Storage Entry (Words 1-6). When used for alphabetic information, only the five low-order positions of a storage-entry word are used. They are wired from second reading. The information entering the units position of the storage-entry word is recoded and entered into the units and tens position of the synchronizer word. The

information entering the tens position of the storage-entry word is recoded and entered into the 3rd and 4th positions of the synchronizer word, etc.

Wiring Example (533-537 Alphabetic Input; Figure 27)

Card columns 25-30 of each card are alphabetic. This

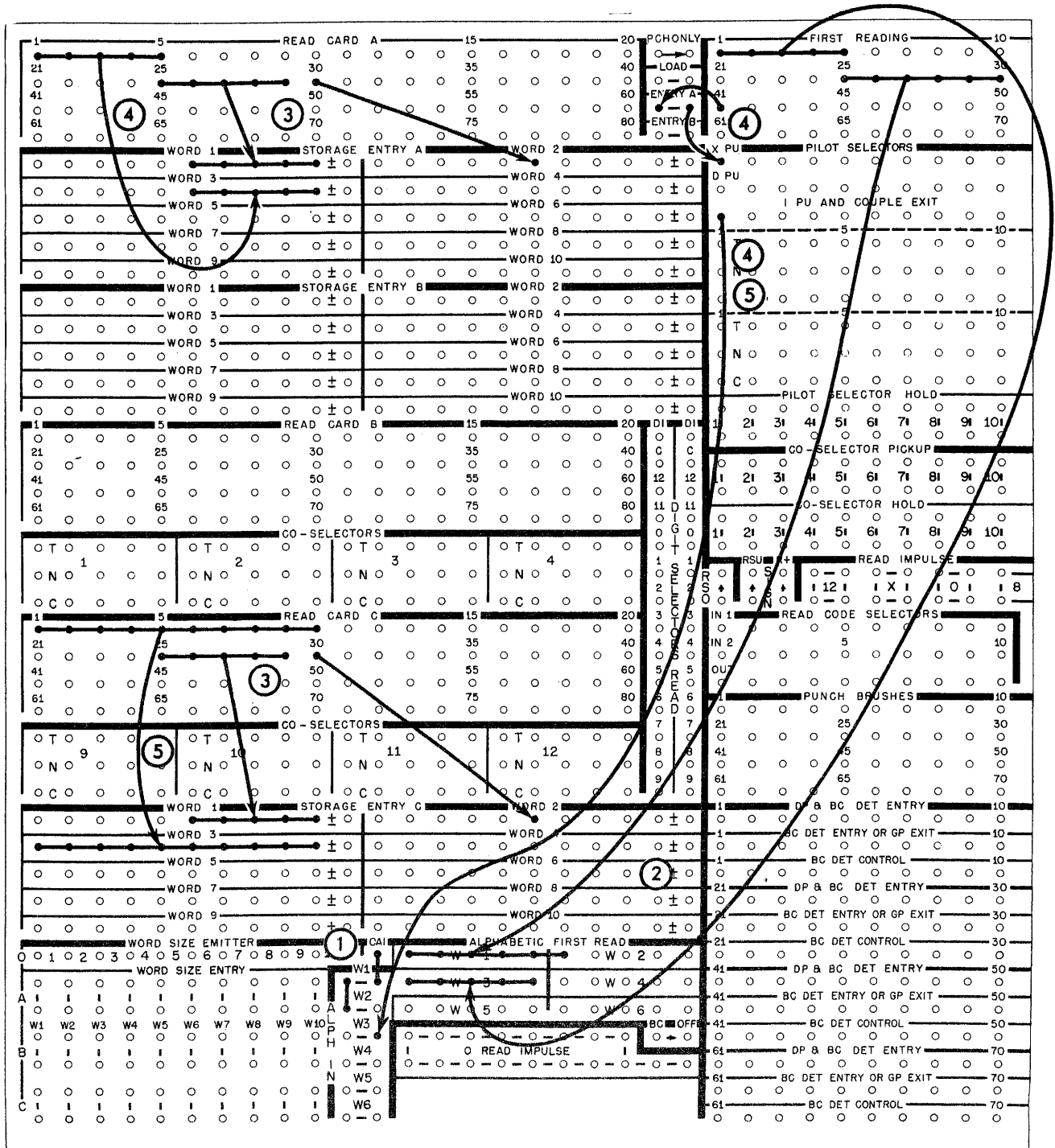

Figure 27. Alphabetic Input, 533-537

information is entered using storage-entry words 1-2. Card columns 1-5 are alphabetic only on cards identified by an X-punch in column 41. This information is entered using storage-entry word 3. On cards not identified by the X-punch in column 41, card columns 1-10 are numerical and are entered using storage-entry word 3.

1. The CAI impulse is used to condition storage-entry words 1-2 to accept and recode alphabetic information from all cards.
2. Card columns 1-5 and 25-30 are analyzed as each card passes first reading. This analysis is used only when the corresponding storage-entry words are conditioned to accept alphabetic data (by impulsing ALPHA IN) as the card passes second reading.
3. Card columns 25-30 are entered into storage-entry words 1-2 on every card through either storage entry A or storage entry C. The information will always be recoded because the corresponding ALPHA IN hubs are impulsed on every cycle and because the corresponding card columns are analyzed as the card passes first reading.

For example, if card columns 25-30 were punched ONE QT, synchronizer word 1 would contain 76 75 65 00 78 +, and synchronizer word 2 would contain 83 00 00 00 00 + as a result of the recoding.

4. The X in column 41 impulses entry A and pilot selector 1 as the X-41 card passes first reading. As a result, when the same card passes second reading, storage entry A is active and word 3 is conditioned to accept and recode alphabetic information, by the couple exit impulse from pilot selector 1. Because entry A will accept any digit impulse (12-9), if column 41 contained any punch 0-9 it would be taken through a column split to isolate the X-impulse.
5. Storage entry C is active for all cards not identified by the X in column 41. Also, word 3 is not conditioned to accept alphabetic information.

Wiring Example (407 Alphabetic Input; Figure 28)

The same conditions exist as in the previous example:

1. The CAI impulse is used to condition storage-entry words 1-2 to accept and recode alphabetic information from all cards.
2. Card columns 1-5 and 25-30 are analyzed as each card passes first reading. This analysis is used

only when the corresponding storage-entry words are conditioned to accept alphabetic data (by impulsing ALPHA IN) as the card passes second reading.

3. Card columns 25-30 are entered into storage-entry words 1-2 on every card. The information is always recoded because the corresponding ALPHA IN hubs are impulsed on every cycle, and because the corresponding card columns are analyzed when the card is at first reading.
4. The X in column 41 impulses pilot selector 1. As a result, when the same card is at second reading the couple exit of pilot selector 1 emits an impulse. This impulse transfers co-selectors 19-20 and also conditions storage-entry word 3 to accept and recode alphabetic information.
5. The information from card columns 1-5 of the X-41 card is routed through the transferred co-selector 20 to the 5 low-order positions of storage-entry word 3. Cards not identified by an X in column 41 use the normal side of co-selectors 19-20 to enter the information from columns 1-10 into storage-entry word 3.

Alphabetic Selection

Selection of alphabetic fields must be based on the function of the alphabetic first read hubs. Each card column wired to alphabetic first read is examined for:

1. any zone punch (0, 11, 12)
2. any numeric punch (1-9)
3. both zone and numerical punching
4. special-character punching (8-3, 8-4) if equipped with special character device (Group II)
5. no punching

These are possible methods of alphabetic selection:

1. Selection is based on an identifying punch in the preceding card. Both the alpha first read and storage-entry wiring are selected.
2. Both alphabetic fields are entered into storage from each card. Selection is then done by programming.
3. If both fields are entirely alphabetic (each column has an alphabetic character A-Z), the alphabetic first read need not be selected. Only the storage-entry wiring is selected.
4. Another method, illustrated in the following wiring example, allows complete flexibility in the selection of those characters handled by the basic alphabetic device only.

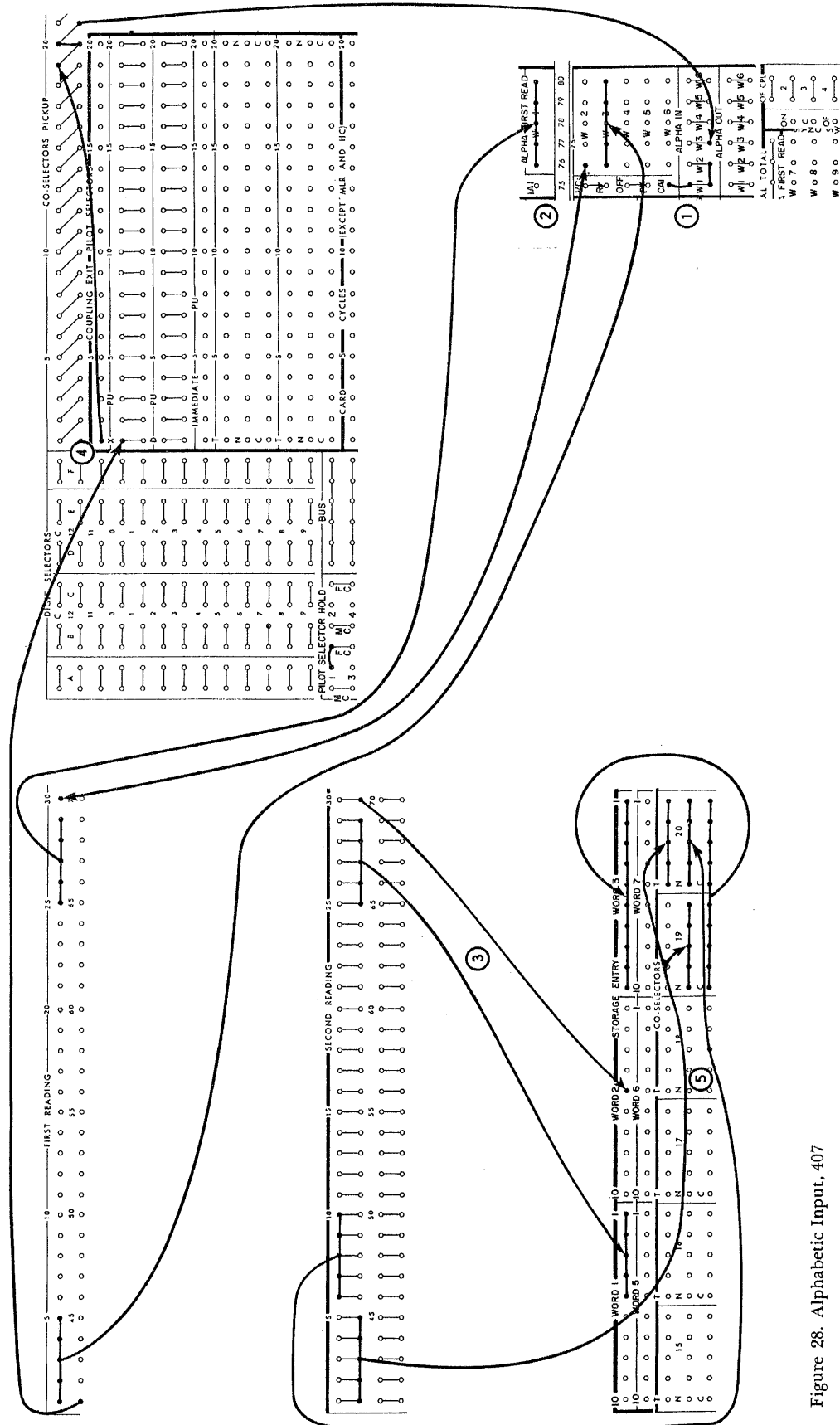

Figure 28. Alphabetic Input, 407

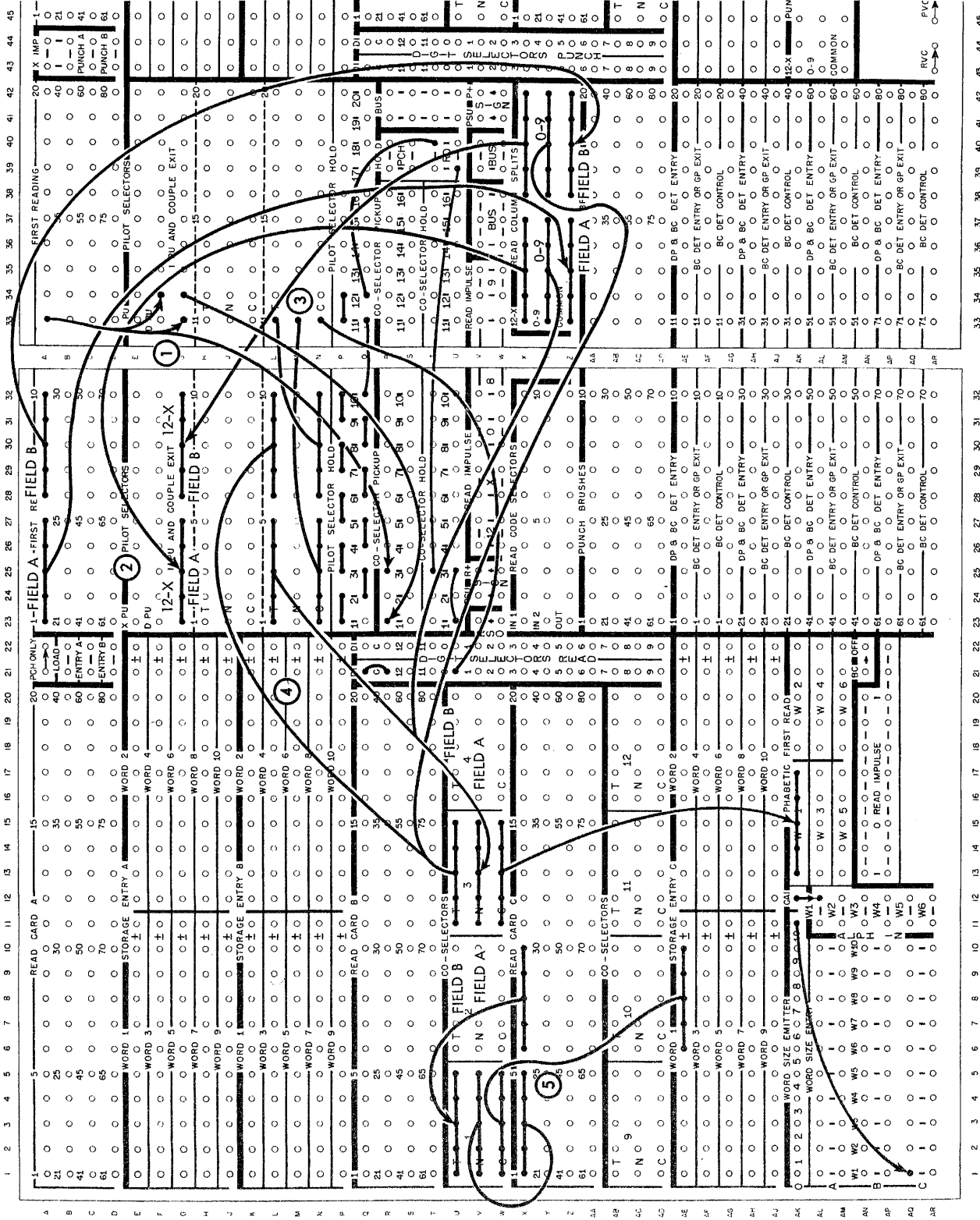

Figure 29. Alphabetic Field Selection

533 Wiring Example (Figure 29)

In this example, the field labeled B is to be selected. This card must be identified by an X- or 12-punch (column 11 in this example).

1. The X- or 12-punch in the field-B card picks up pilot selector 3 while the card is at first reading and pilot selector 12 and co-selector 1 when the card is at second reading.
2. Each column of each field is checked for the presence of an X- or 12-punch using pilot selectors 1-10.
3. The zero impulse tests each pilot selector within a field (which field is determined by selector 11) to see if an X- or 12-punch was read.
4. For those columns that do have an X- or 12-punch, a zero impulse is substituted in alpha first read.
5. Storage-entry wiring is selected in the usual manner. The same principles can be applied to 537 and 407 input.

OUTPUT

Basically, two things are necessary for alphabetic output:

1. Indicate on the output-unit control panel, which of the first six storage-exit words are to be used for alphabetic information.
2. The alphabetic information in the designated output word must be a valid two-digit form so that it can be decoded.

Control Panel

The following hubs are associated with alphabetic output. For the 533-537, see Figure 30. For the 407, see Figure 31.

CAI (Constant Alphabetic Impulse). This impulse is available on every card-feed (print) cycle except load cycles. It can be used to impulse alpha out on the 537 and 407. It cannot be used for alpha out on the 533.

Alpha Out (Alphabetic Out). These hubs are entries. When any one is impulsed, the corresponding storage-exit word is conditioned to decode and emit alphabetic information. When constant alphabetic output is desired, the CAI impulse can be used on the 537 and 407, or psu (Lower) on the 533. Selective control can be achieved using control information.

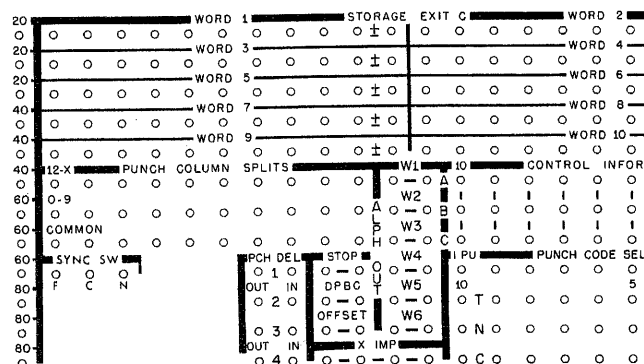

Figure 30. Alphabetic Output Control-Panel Hubs, 533-537

Storage Exit (Words 1-6). When used for alphabetic output, only the five low-order positions of a storage-exit word are active, and the decoding proceeds in exactly the opposite manner to that of input.

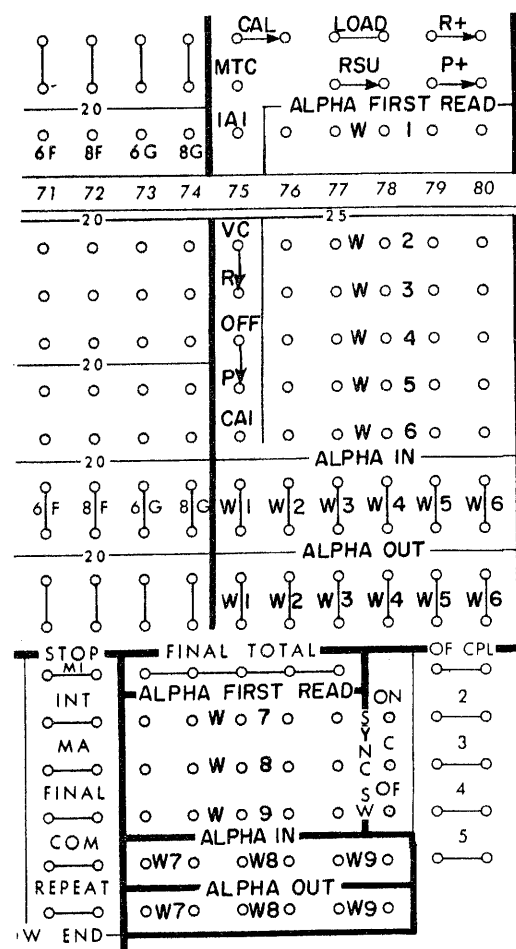

Figure 31. Alphabetic Output Control-Panel Hubs, 407

Wiring Example (533-537 Alphabetic Output;
Figure 32)

This example will reproduce in the output cards, fields similar to the input cards used in Figure 27.

1. The PSU impulse (533 only) or the CAI impulse (537 only) is used to condition storage-exit words 1-2 for alphabetic output on each card feed cycle.
2. An 8 in position 7 of output word 10 is used to

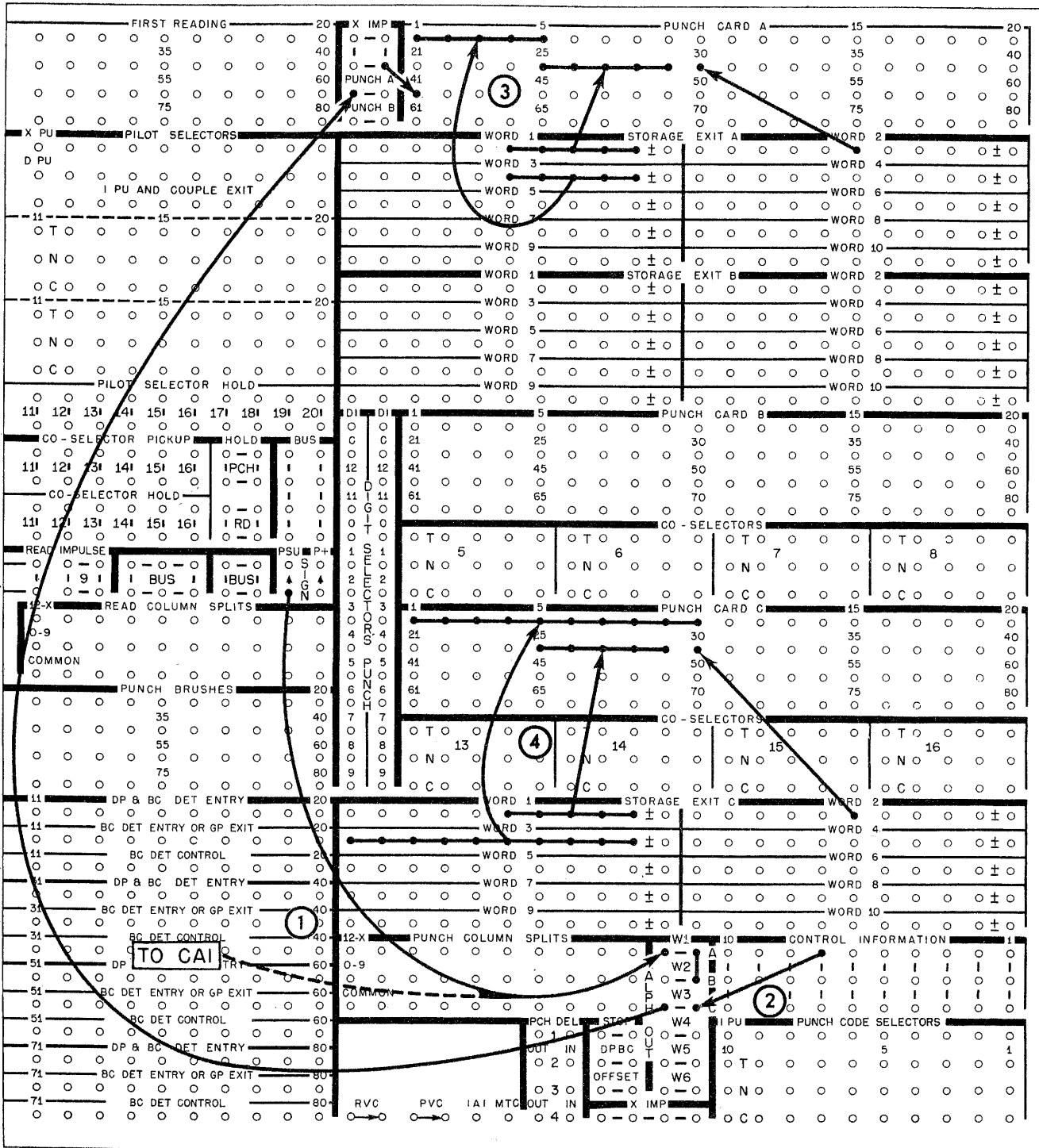

Figure 32. Alphabetic Output, 533-537

condition storage-exit word 3 for alphabetic output and to condition punch card A to accept information.

3. On output cycles designated by the control information impulse, punch card A accepts information and punch card C does not. This card is identified by an X-punch in column 41.
4. On output cycles not designated by the control information impulse, punch card C accepts information and punch card A does not.

Wiring Example (407 Alphabetic Output; Figure 33)

This example prints information similar to the output cards in the previous example:

1. The CA1 impulse is used to condition storage-exit words 1-2 for alphabetic output on each print cycle.
2. An 8 in position 7 of output word 10 is used to condition storage-exit word 3 for alphabetic output and to pick up pilot selector 1.

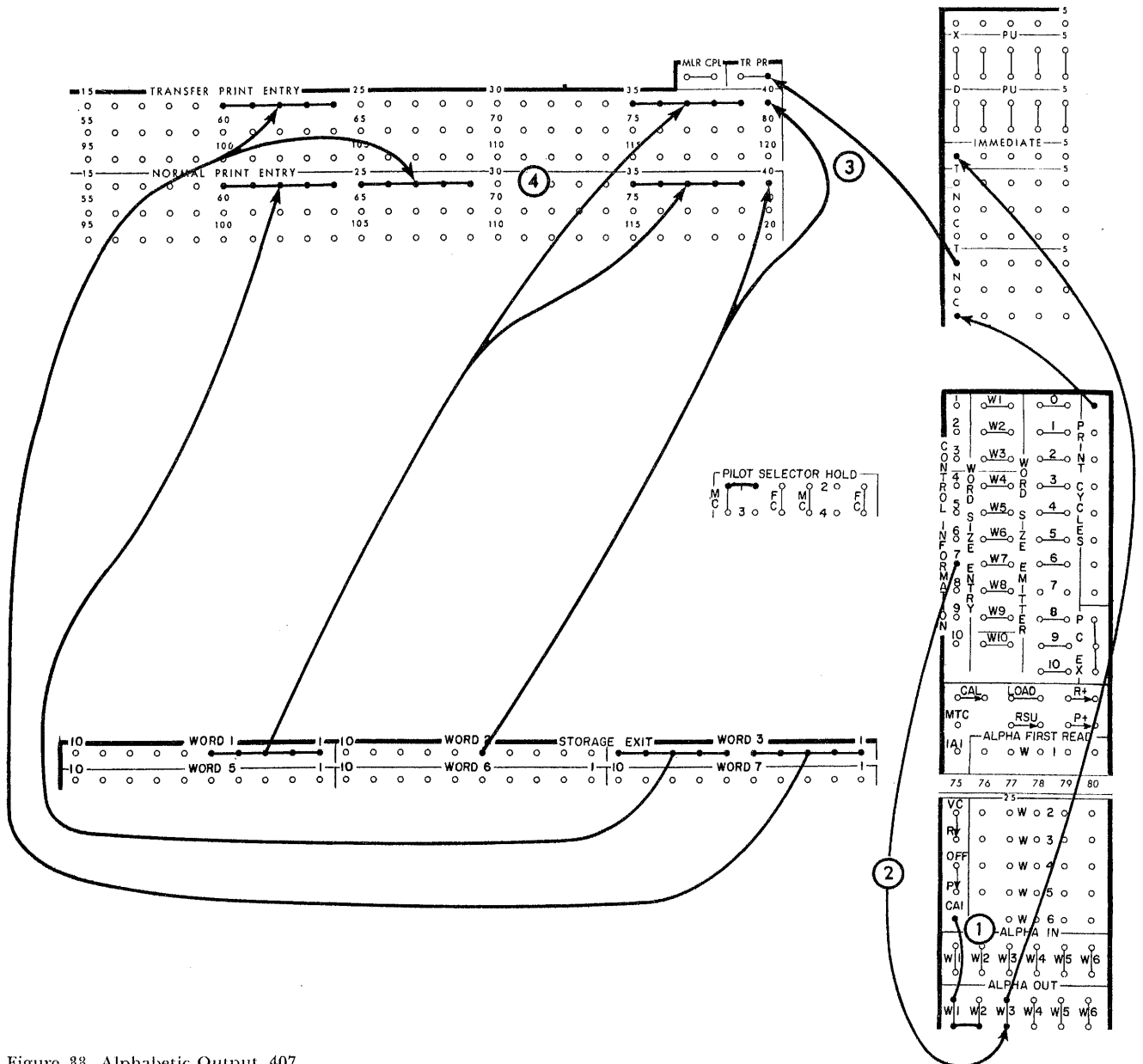

Figure 33. Alphabetic Output, 407

3. The print cycles impulse, through the transferred pilot selector, impulses transfer print.
4. On output cycles designated by the control information impulse, transfer print entry accepts information and normal print entry does not. On output cycles not designated by the control information impulse, normal print entry accepts information and transfer print entry does not.

Auxiliary Alphabetic Unit (654)

The major function of this unit is to expand the alphabetic input-output capacity of a 533, 537, or 407 that is already equipped with the basic alphabetic device. It can expand the standard alphabetic device of 30 characters to handle full card alphabetic operations for one or two input-output units (Figure 34).

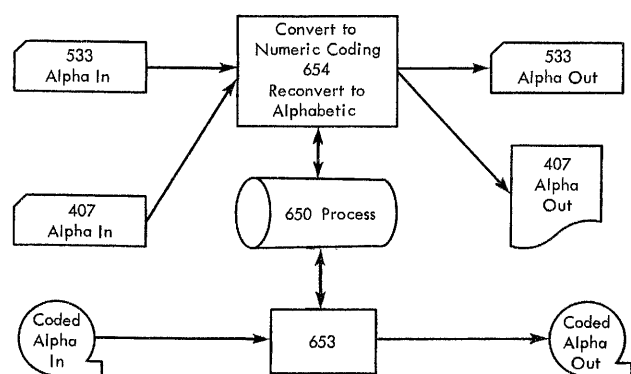

Figure 34. Alphabetic Data Flow Schematic

The 654 is available in four models. Models 1 and 2 expand the capacity of one input-output unit, and Models 3 and 4 expand the capacity of two input-output units. A special character option can be added to the 654 if the input-output units to be used with it are so equipped.

The basic capacity of an input-output synchronizer is ten words, six of which can handle alphabetic information (30 characters). The 654, expands the total capacity to either 15 or 17 words depending on the 654 model specified. The 15 word model (1,3) can handle up to 12 words (60 characters) of alphabetic information. The 17 word model (2,4) can handle up to 16 words (80 characters) of alphabetic information. In addition, any input-output units which are not connected through the 654 can have the standard basic

alphabetic device. Therefore, in a 650 system equipped with three input-output units and the 654 Model 4, up to 190 characters of alphabetic information can be handled.

Synchronizer Arrangement

When the 654 Auxiliary Alphabetic Unit is added to the 650 system, the input-output synchronizer arrangement is changed to accommodate the expanded capacity. This rearrangement is controlled by two synchronizer switches (SYNC SW); one switch is on the 654 control panel and the other on the input-output control panel.

To use the 654, all synchronizer switches must be wired ON.

When an input-output unit is not being used with the auxiliary alphabetic unit the SYNC SW on the input-output unit must be wired OFF. When this is done, the synchronizer reverts to the standard 10-word capacity. The synchronizers used and the amount of expansion is determined by the 654 model being used.

Model 1. This model expands the input-output capacity (for only one of the input-output units) from 10 words to 15 words. Twelve of the fifteen words can handle alphabetic information. They are words 1 through 9 and 11 through 13. Words 14 and 15 cannot be used for alphabetic characters. Word 10 is the control word and cannot be alphabetic. The expanded-capacity input-output unit must be connected to the number one synchronizer cable connector on the 655 Power Unit. Figure 35 shows the synchronizer arrangement of the 654 Model 1 when the synchronizer switches (654 and Input-Output Unit) are wired ON.

Model 2. This model is the same as Model 1, except that the expansion is from 10 words to 17 words, 16 of which can be used for alphabetic information. They are words 1 through 9 and 11 through 17. Word 10 continues to be the control word and cannot be used for alphabetic information. Figure 36 shows the synchronizer arrangement of this model when the synchronizer switches (654 and Input-Output Unit) are wired ON.

Model 3. This model expands the input-output capacity (for each of two input-output units) from 10 words to 15 words. Twelve of the 15 words can handle alphabetic information. The expanded capacity input-output units must be connected to the cable connectors for synchronizers 1-2 on the 655 Power Unit. Figure 37 shows the synchronizer arrangement of this model when the synchronizer switches (654 and Input-Output Unit) are wired ON.

Model 1		Synchronizers	
Input 1 (70, 72)		0	
Input 3 (76, 78)		00	50
Output 2 (74)		01	51
Output 3 (77)		02	52
Input 2 (73, 75)		03	53
Output 1 (71)		04	54
		05	55
		06	56
		07	57
		08	58
		09	59
		10	60
		11	61
		12	62
		13	63
		14	64
		15	65
		16	66
		17	67
		18	68
		19	69
		20	70
		21	71
		22	72
		23	73
		24	74
		25	75
		26	76
		27	77
		28	78
		29	79
		30	80
		31	81
		32	82
		33	83
		34	84
		35	85
		36	86
		37	87
		38	88
		39	89
		40	90
		41	91
		42	92
		43	93
		44	94
		45	95
		46	96
		47	97
		48	98
		49	99

Figure 35. Model 1 Drum Synchronizer Arrangement

Model 2		Synchronizers	
Input 1 (70, 72)		0	
Input 3 (76, 78)		01	51
Output 2 (74)		02	52
Output 3 (77)		03	53
Input 2 (73, 75)		04	54
Output 1 (71)		05	55
		06	56
		07	57
		08	58
		09	59
		10	60
		11	61
		12	62
		13	63
		14	64
		15	65
		16	66
		17	67
		18	68
		19	69
		20	70
		21	71
		22	72
		23	73
		24	74
		25	75
		26	76
		27	77
		28	78
		29	79
		30	80
		31	81
		32	82
		33	83
		34	84
		35	85
		36	86
		37	87
		38	88
		39	89
		40	90
		41	91
		42	92
		43	93
		44	94
		45	95
		46	96
		47	97
		48	98
		49	99

Figure 36. Model 2 Drum Synchronizer Arrangement

Model 3		Synchronizers	
Input 1 (70, 72)		0	
Input 2 (73, 75)		01	51
Output 3 (77)		02	52
Input 3 (76, 78)		03	53
Output 2 (74)		04	54
Output 1 (71)		05	55
		06	56
		07	57
		08	58
		09	59
		10	60
		11	61
		12	62
		13	63
		14	64
		15	65
		16	66
		17	67
		18	68
		19	69
		20	70
		21	71
		22	72
		23	73
		24	74
		25	75
		26	76
		27	77
		28	78
		29	79
		30	80
		31	81
		32	82
		33	83
		34	84
		35	85
		36	86
		37	87
		38	88
		39	89
		40	90
		41	91
		42	92
		43	93
		44	94
		45	95
		46	96
		47	97
		48	98
		49	99

Figure 37. Model 3 Drum Synchronizer Arrangement

Model 4. This model is the same as Model 3, except that the expansion is from 10 words to 17 words, 16 of which can be used for alphabetic information. Figure 38 shows the synchronizer arrangement of this model when synchronizer switches (654 and Input-Output Unit) are wired ON. Figure 39 illustrates standard synchronizer arrangement with the synchronizer switches OFF.

654 Control Panel

The left-hand section of this control panel (Figure 40) is used on all model 654's to control the alphabetic card input-output unit connected to synchronizer 1.

The right-hand section is used on models 3-4 to control a second alphabetic card input-output unit connected by synchronizer 2. The number following the hub name is its general location on Figure 40.

INPUT

Sync Sw (3) (left-hand panel only). When this switch and the SYNC SW on the input-output unit are wired ON, the synchronizers are altered to accept expanded alphabetic input-output (as shown in Figures 35, 36, 37, 38).

First Reading (1). These hubs are exits for information read from the card at the first reading station. This information is normally entered into the alphabetic first read hubs.

Model 4		Synchronizers	
Input 1 (70, 72)	Input 2 (73, 75)	Input 3 (76, 78)	Output 1 (71)
00	01	02	03
04	05	06	07
08	09	10	11
12	13	14	15
16	17	18	19
20	21	22	23
24	25	26	27
28	29	30	31
32	33	34	35
36	37	38	39
40	41	42	43
44	45	46	47
48	49	50	51
52	53	54	55
56	57	58	59
60	61	62	63
64	65	66	67
68	69	70	71
72	73	74	75
76	77	78	79
80	81	82	83
84	85	86	87
88	89	90	91
92	93	94	95
96	97	98	99

Figure 38. Model 4 Drum Synchronizer Arrangement

Synchronizers		0	
Input Sync. 2 (OP 73,75)	Output Sync. 1 (OP 71)	Output Sync. 2 (OP 74)	Input Sync. 1 (OP 70,72)
00	01	02	03
04	05	06	07
08	09	10	11
12	13	14	15
16	17	18	19
20	21	22	23
24	25	26	27
28	29	30	31
32	33	34	35
36	37	38	39
40	41	42	43
44	45	46	47
48	49	50	51
52	53	54	55
56	57	58	59
60	61	62	63
64	65	66	67
68	69	70	71
72	73	74	75
76	77	78	79
80	81	82	83
84	85	86	87
88	89	90	91
92	93	94	95
96	97	98	99

Figure 39. Standard Synchronizer Arrangement

INTERNATIONAL BUSINESS MACHINES CORPORATION
 650 DATA-PROCESSING SYSTEM
 654 AUXILIARY ALPHABETIC UNIT, CONTROL PANEL

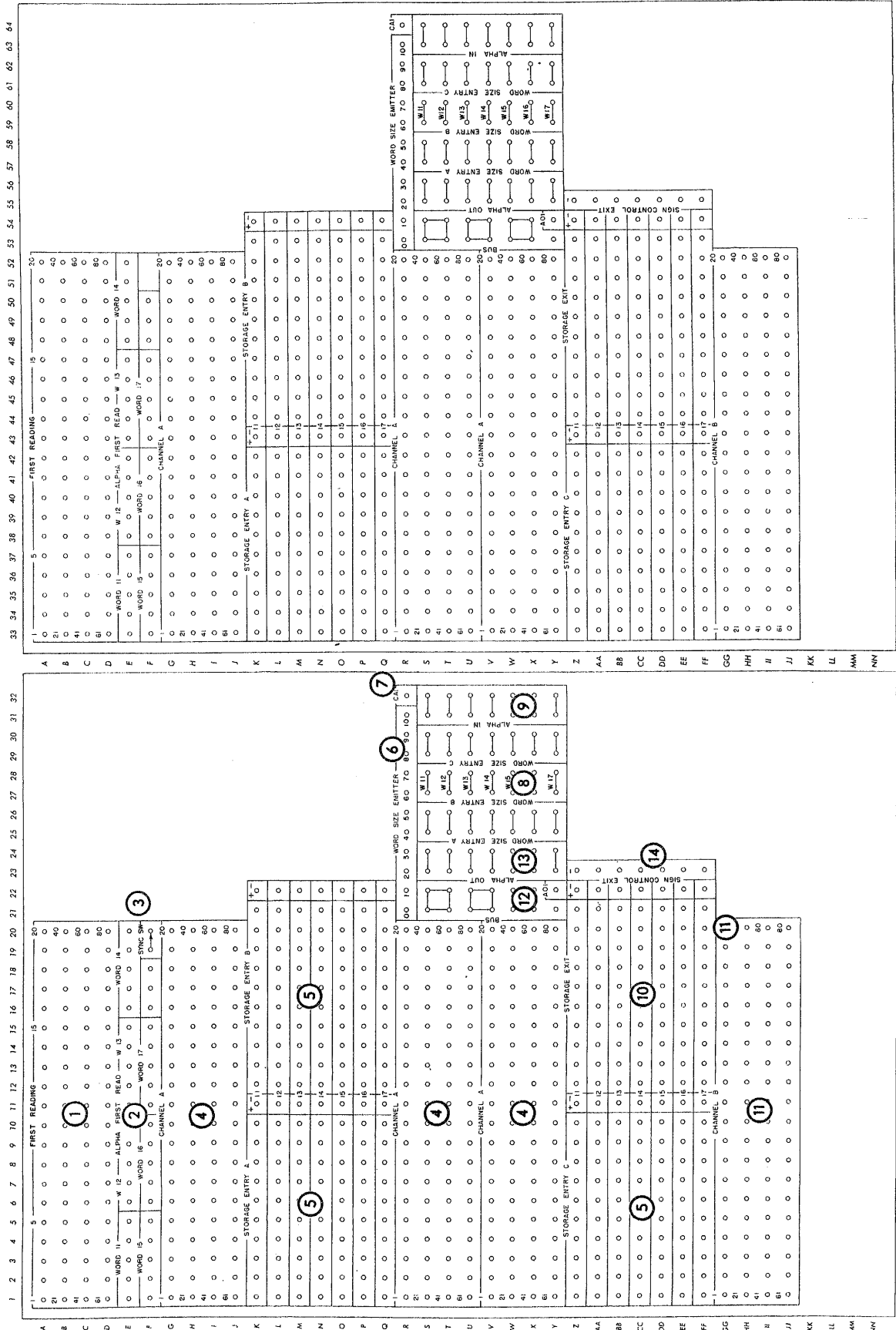

Figure 40. 654 Control Panel

Alpha First Read (2). These are *entry* hubs for information wired from first reading hubs. The alphabetic columns to be read from the card are entered directly, as required, to condition the word to receive alphabetic information.

Channel A (4). These hubs are internally cable-connected to the channel A hubs on the card input-output unit control panel. They are normally used to carry information from the card input-output unit to the 654. The channel A hubs are added to the card input-output unit when it is to be used with the 654.

Storage Entry A-B-C (5). Each group of storage-entry hubs (A, B, or C) is independent of the other two. This arrangement permits the entry of information from at least three different card forms without using pilot selectors or co-selectors.

Only one group of storage entry hubs (A, B, or C) can be active during one particular card cycle. Storage-entry C hubs are normally active and are the only ones active on the 407. Storage-entry A hubs are made active by impulsing entry A hubs on 533 or 537 on the previous cycle. Storage-entry B hubs are made active by impulsing entry B hubs on 533 or 537 on the previous cycle.

Storage-entry hubs (A, B, or C) are normally impulsed from the second read station. The card columns to be entered are wired from the second reading station to channel A hubs on the card input-output unit. The corresponding channel A hubs on the 654 control panel are then wired to the five low-order digits of the storage-entry hubs.

Word-Size Emitter (6). These are *exit* hubs which are used to fill in zeros, automatically, to the left of the last storage-entry word position wired from the second reading station (numbered only).

CAI (7). These *exit* hubs emit a constant alphabetic impulse, except during load cards. These hubs can be used to impulse the desired alphabetic-in hubs.

Word-Size Entry A-B-C (8). These hubs are *entries* for the impulses from the word-size emitter hubs. They are receptive when their corresponding storage-entry hubs

are active. Only the C entries should be used on the 407.

They must be wired from word-size emitter hub 10 for each alphabetic word.

Alpha in (9). These *entry* hubs must be impulsed to set up the corresponding storage entry word to receive alphabetic information. Normally wired from the constant alphabetic impulse (CAI) exit hub.

NOTE: PSU, P+, RSU, and R+ are wired on the input-output machine. All expanded words operate similarly to words in the input-output unit.

OUTPUT

Storage Exit (10). These hubs emit the impulses which are used for punching or printing the result. They are normally wired to channel B hubs.

Channel B (11). These hubs are internally cable-connected to the channel B hubs on the card input-output units control panels. These are normally used to carry information from the 654 to the card input-output unit (storage-exit hubs to channel B entry on 654; channel B exit to PUNCH or PRINT on card input-output unit).

AOI (12). These *exit* hubs emit an early timed impulse and they can be used to impulse the desired alphabetic-out hubs.

Alpha Out (13). These *entry* hubs receive impulses to convert the corresponding storage-exit word to alphabetic output. Normally wired from the alphabetic-out impulse (AOI) exit hubs.

Sign Control Exit (14). These emit an early impulse when a minus amount is read out of the corresponding exit word. When wired through the channel hubs to the immediate pickup of pilot selectors or co-selectors on the 407, this impulse allows these selectors to transfer in sufficient time for the selection of card cycles, all cycles, and print cycles impulses. These hubs should not be used for 533 or 537 operations.

533, 537 and 407 Control Panels. Figure 41 shows the modified 533-537 control panel for use with the 654. Figure 42 shows the modified 407 control panel for use with the 654.

Wiring Example

Alphabetic MLR cards are interspersed in file being fed into the system in the 533 Read Feed (Figure 43).

Single-line alphabetic headings are to be printed by the 407.

This sample application (Figure 44) illustrates the control-panel wiring, on each unit, for processing four alphabetic card columns. The wiring illustrated would be repeated to cover as many card columns as necessary to enter this entire address into the system.

533 OR 537 CONTROL PANEL WIRING (FIGURE 45)

1. At the first reading station, the 80-column 12-punch is sensed and filtered through the read column splits. This impulse enters the entry A hubs which conditions the storage entry A words to accept information. This impulse also picks pilot selector 1 through its X pickup.

2. The storage entry A words being conditioned to accept information allows the read impulse 8 to be

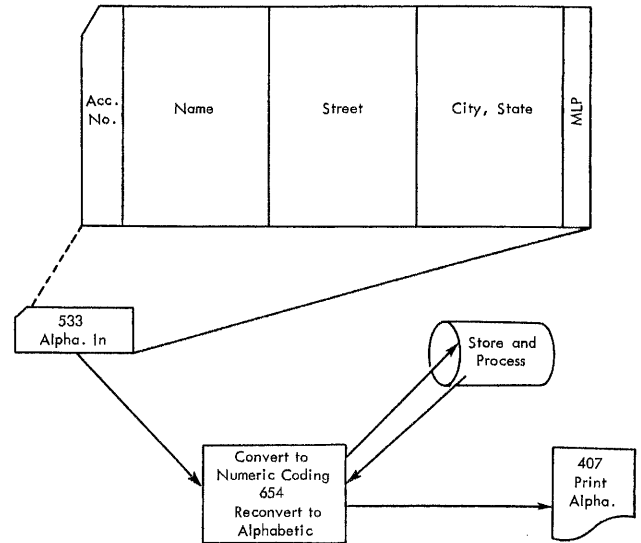

Figure 43. Data Flow Schematic

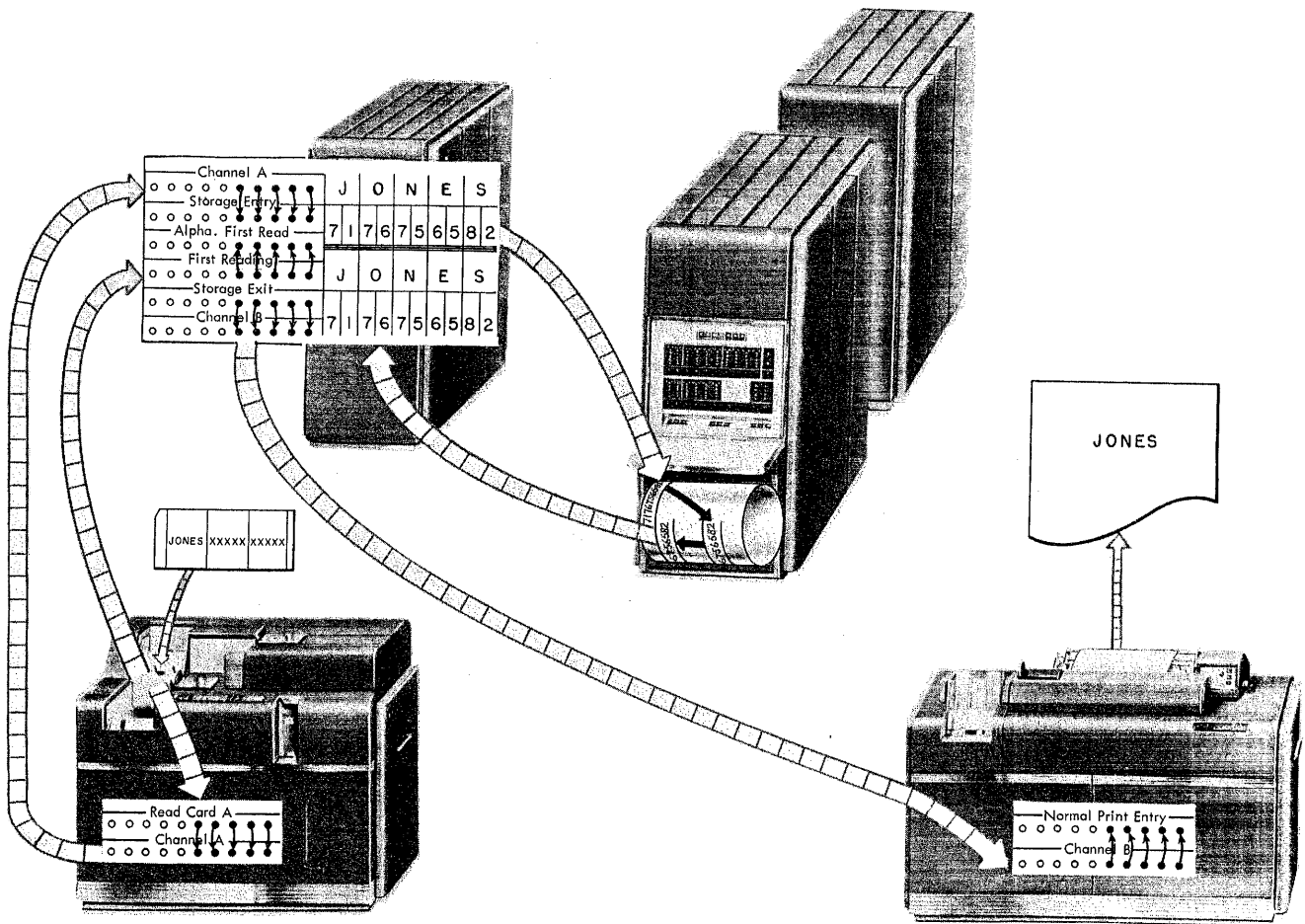

Figure 44. Data Flow Sample Application

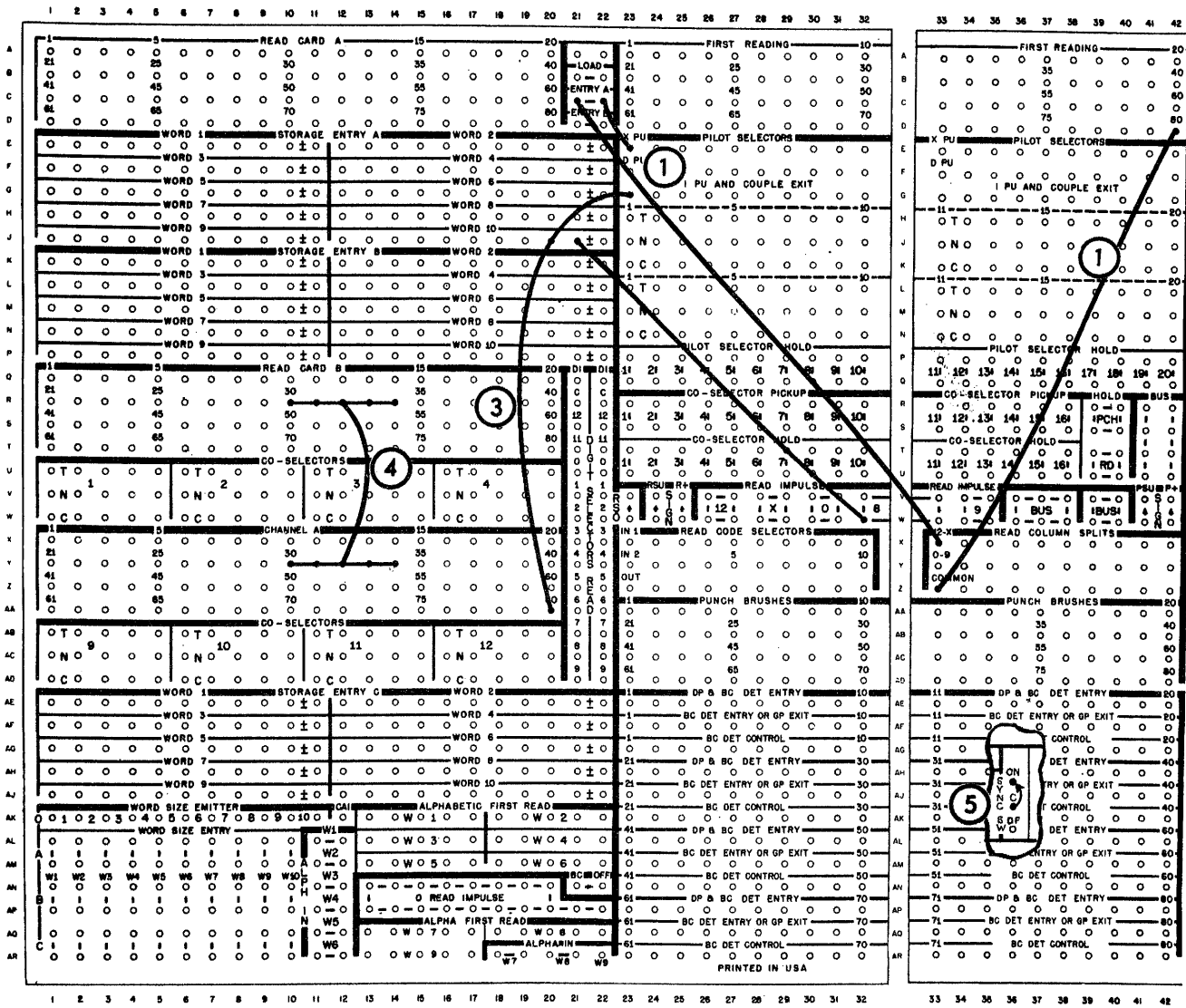

Figure 45. 533 Control Panel Wiring

read into the units position of word 10. This 8 will be used to control the printed output.

3. The couple exit impulse from pilot selector 1 is fed into the channel A hub 80 for use on the 654 control panel.

4. The information that is read at the second reading station (read card B; numerical portion of word Jones) is fed into channel A hubs for use on the 654 control panel.

5. Sync sw wired on.

NOTE: The Sync sw on the 533-537 must be wired. It must be wired ON to use the expanded alphabetic unit. It must be wired OFF to use the 533-537 without the expanded alphabetic unit.

654 CONTROL PANEL WIRING (FIGURE 46)

3. The couple exit impulse conditioned by the 12 in the MLR card is transmitted through the cable to the channel A hubs. This impulse is wired to word 11 alphabetic-in hubs to condition the word 11 alphabetic first read hubs to accept the alphabetic zones from the first reading station.

4. Numerical portion of the alphabetic information (Jones) read at the second reading station (read card B) is fed through the cable on channel A to enter the storage entry A hubs for word 11. The storage entry A hubs are conditioned by the entry A hubs on the 533 control panel.

5. Zones for the alphabetic information (Jones) are

read at the first reading station in the 533 and are wired to alphabetic first read for word 11.

6. Word-size emitter 10 is wired to word-size entry A for word 11 to enter zeros in any unused positions within the word.

7. Storage exit of output synchronizer 2, while it is partially converted back to alphabetic information, is fed into channel B for transmission to the attached 407.

8. Control alphabetic information signal from 407 control panel through channel B to impuls alphabetic-out hubs of word 11. This conditions word 11 to emit impulses through the storage exit hubs.

407 CONTROL PANEL WIRING (FIGURE 47)

8. Control alphabetic information impulse wired through pilot selector to channel B hub. Channel B carries impulse to 654 for use on its control panel.

9. The 8 stored in word 10 on the read operation on the 533 is now used to signal an alphabetic output. The units position of word 10 through control information 1 hub picks pilot selector 20

10. Pilot selector hold for selectors 15-20, which is marked 4, is wired to MC machine cycle to hold selectors through the print cycle.

11. Exit impulses of word 11 are brought through

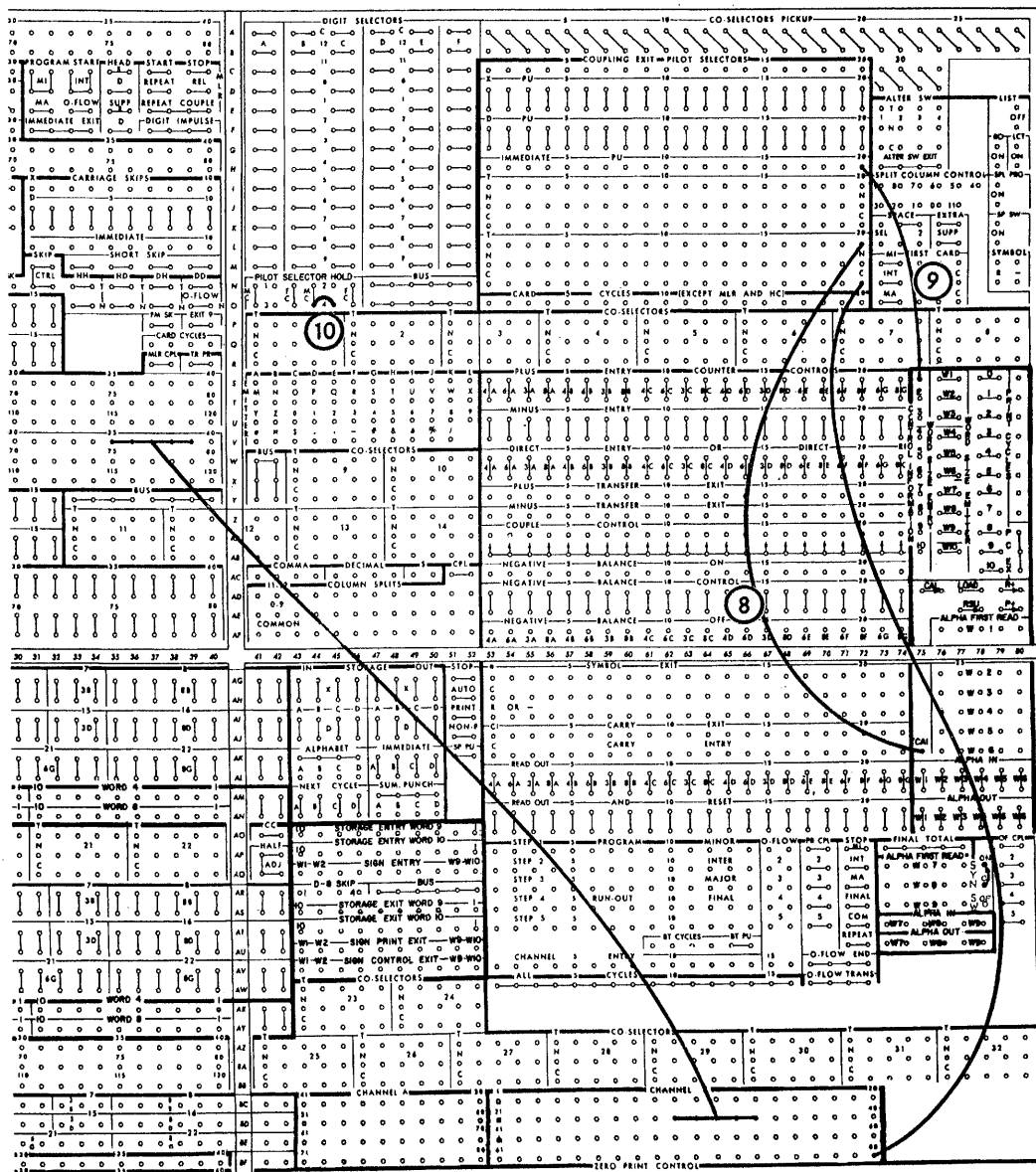

Figure 47. 407 Control Panel Wiring

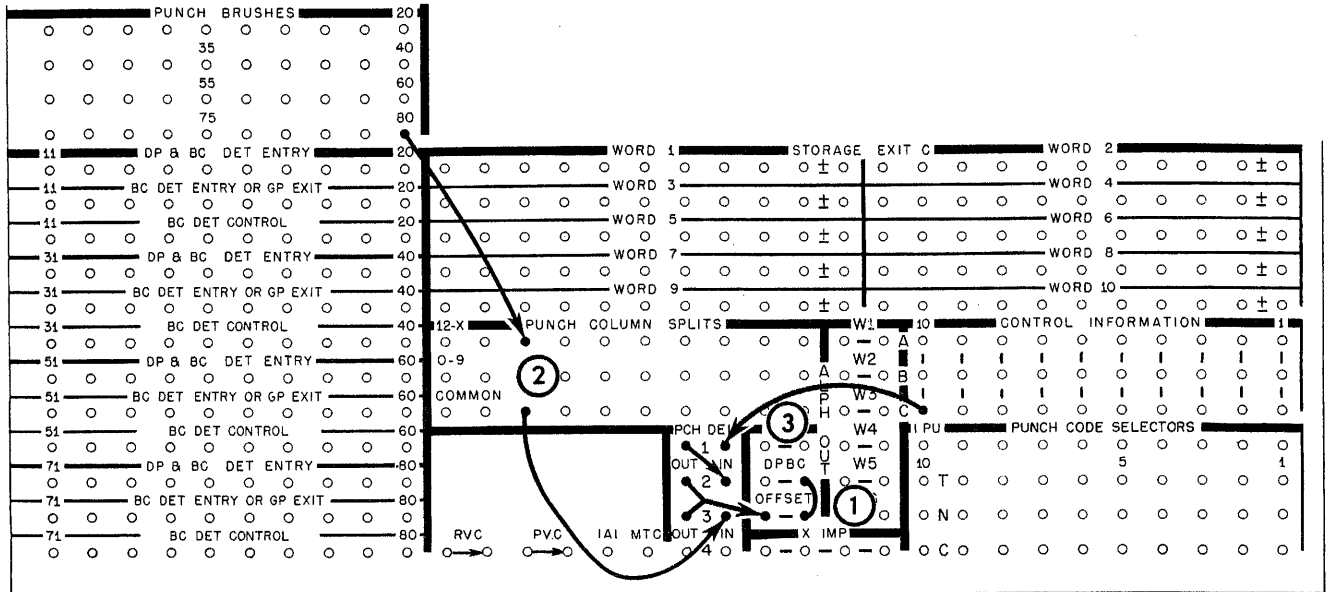

Figure 48. Offset Stacking, 533

channel B hubs and wired to normal print entry where final conversion to alphabetic word (Jones) is completed.

Half-Time Emitter

This device is available for both the 533 and 537. It is similar in operation to the digit emitter except that a half-time impulse starts when the corresponding digit impulse (12-9) ends, and stops when the next digit impulse begins. The half-time impulses are usually used to transfer selectors between two specific digits.

One or two half-time emitters can be installed in both the 533 and 537. When both are installed in the 533, one is timed to the reading function and is located next to the digit selector read. The other is timed to the punching function and is located next to the digit selector punch.

In the 537, both are timed the same, and can be used interchangeably. If the half-time emitter (s) is not installed, additional digit selectors can be installed.

Offset Stacking Device

This device is available for both the 533 and 537. It is used to locate specified cards by offsetting them $\frac{3}{8}$ " toward the front of the machine. The operation of the device is by control-panel wiring. When installed on the 533, it is placed in the punch stacker.

533 Wiring Example (Figure 48)

This example illustrates ways of activating the offset stacker in the 533:

1. Any card in which a DPBC error is detected is offset.

2. Any card with an 11- or 12-punch in column 80 is offset one cycle after the 11 or 12 is read at the punch brushes. The one-cycle delay is achieved by using the punch delay.
3. Any card identified by control information 10 is offset two cycles after the card is punched at the punch station. The two-cycle delay is achieved by using two punch-delay units.

537 Wiring Example (Figure 49)

This example illustrates ways of activating the offset stacker in the 537:

1. Any card in which a DPBC error is detected is offset.
2. Any card identified by control information 10 is offset two cycles after the card is punched at the punch station. The two-cycle delay is achieved by using punch delay.

NOTE: In the 537, the use of punch delay 1 or 2 will cause two cycles delay; the use of punch delay 3 or 4 will cause three cycles delay.

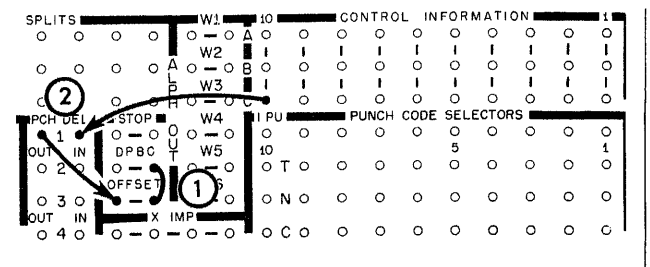

Figure 49. Offset Stacking, 537

Read Code Selectors

The major function of this device is to recode card information into either 8's or 9's before it is entered into the system. The recoded information is usually entered into the system for interrogation by the branch distributor codes (90-99), or for use as control information words.

These selectors are available for both the 533 and 537 in one or two groups of five each. Associated with each group of read-code selectors is a corresponding group of punch-code selectors.

Each individual read-code selector consists of three associated control-panel hubs: IN 1, IN 2, and OUT. Associated with all of the read-code selectors is the RSO (Read Second Only) switch. The function of the IN 1 and IN 2 hubs is dependent upon the wiring of the RSO switch.

IN 1. This entry accepts 12-7 digit impulses, and is usually wired from first reading when RSO is *not* wired. Under these conditions the impulse entering IN 1 must occur one cycle before the impulse entering the corresponding IN 2. When the RSO switch is wired, IN 1 is usually wired from read card A, B, C. Under these conditions IN 1 and IN 2 must receive impulses during the same cycle.

IN 2. This entry accepts 12-7 digit impulses and is usually wired from read card A, B, C.

OUT. This is an exit hub. If both IN 1 and IN 2 receive an impulse (12-7), the corresponding OUT hub emits an 8-impulse during the same cycle that IN 2 is impulsed. If neither IN 1 nor IN 2 receive an impulse, the corresponding OUT hub emits a 9-impulse. If only one of the IN hubs receives an impulse, the corresponding OUT hub does *not* emit.

RSO (Read Second Only). When this switch is wired, both IN 1 and IN 2 must receive an impulse during the same cycle, if the corresponding OUT hub is to emit an 8 during that cycle. When this switch is not wired, the IN 1 hub must receive an impulse one cycle before the corresponding IN 2 hub, if the associated OUT hub is to emit an 8 during the cycle that the IN 2 is impulsed.

Wiring Example (Figure 50)

This example illustrates the wiring of the read-code selectors when RSO is not wired:

1. Any digit impulse (12-7) read at first reading column 80 activates IN 1.
2. Any digit impulse (12-7) read at second reading column 80 activates IN 2.

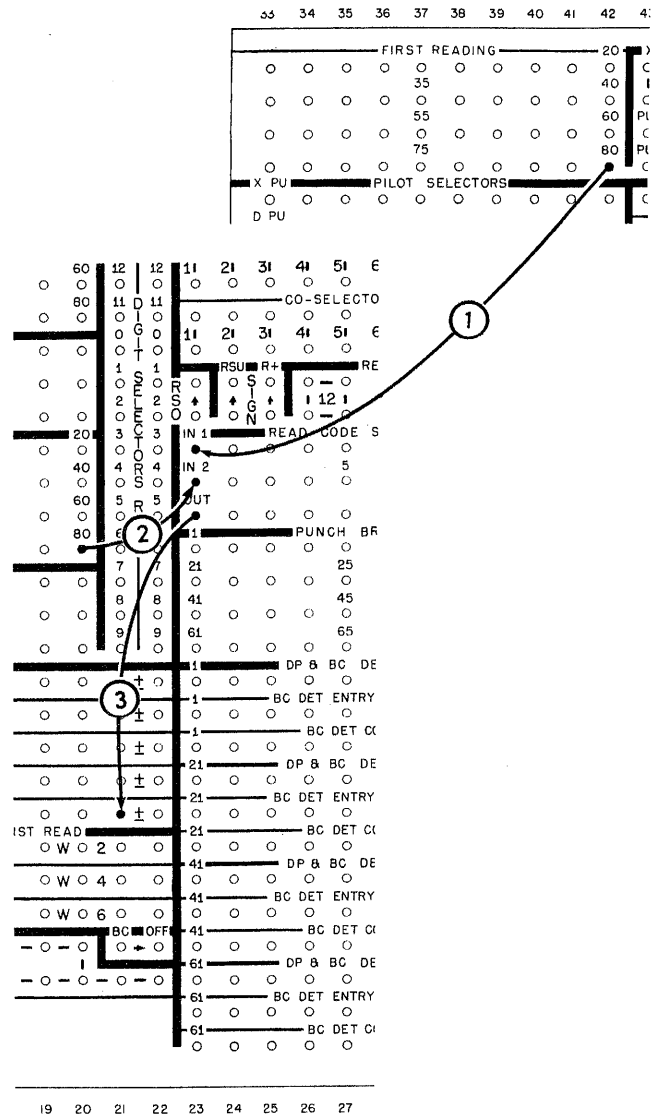

Figure 50. Read Code Selectors

3. If both IN 1 and IN 2 are impulsed from the same card, the OUT hub emits an 8. If neither IN 1 nor IN 2 receives an impulse from the same card, the OUT hub emits a 9. If only one of IN hubs, receives an impulse from the same card, the OUT hub will not emit.

Wiring Example (Figure 51)

This example illustrates the wiring of the read-code selectors when RSO is wired:

1. Both IN 1 and IN 2 are wired from second reading.
2. Either an 8- or 9-impulse is emitted from the OUT hub depending on the punching in column 80 of the card.

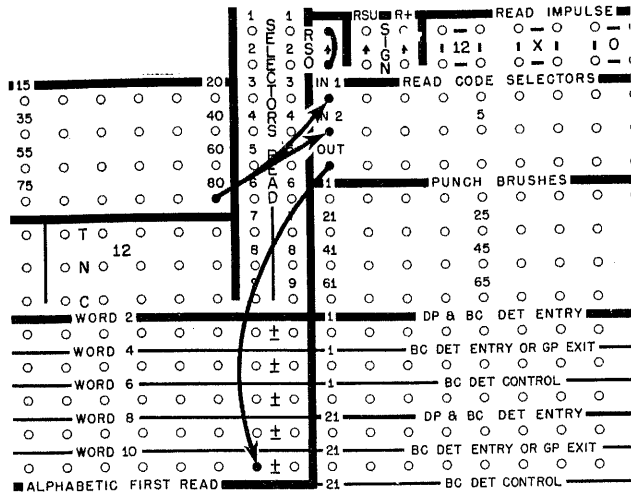

Figure 51. Read Code Selectors with RSO

Punch Code Selectors

The major function of this device is to recode control information impulses into digit punches to identify the card being punched.

These selectors are available for both 533 and 537, in one or two groups of five each, and are installed with the corresponding group of read-code selectors.

Each selector consists of an immediate pickup hub and a single set of transfer points. Once impulsed, the selector remains transferred until the end of the cycle during which it was picked up. In the 533, the pickup impulse must be timed to the punching function.

Wiring Example (Figure 52)

This example illustrates the use of punch-code selectors:

1. A control information impulse from position 9 (available if there is an 8 in this position), picks up the punch-code selector, and it remains transferred for the remainder of the cycle.
2. When the selector is transferred, a 3 is punched in column 80 of the card. When the selector is normal, an 11 is punched in column 80.

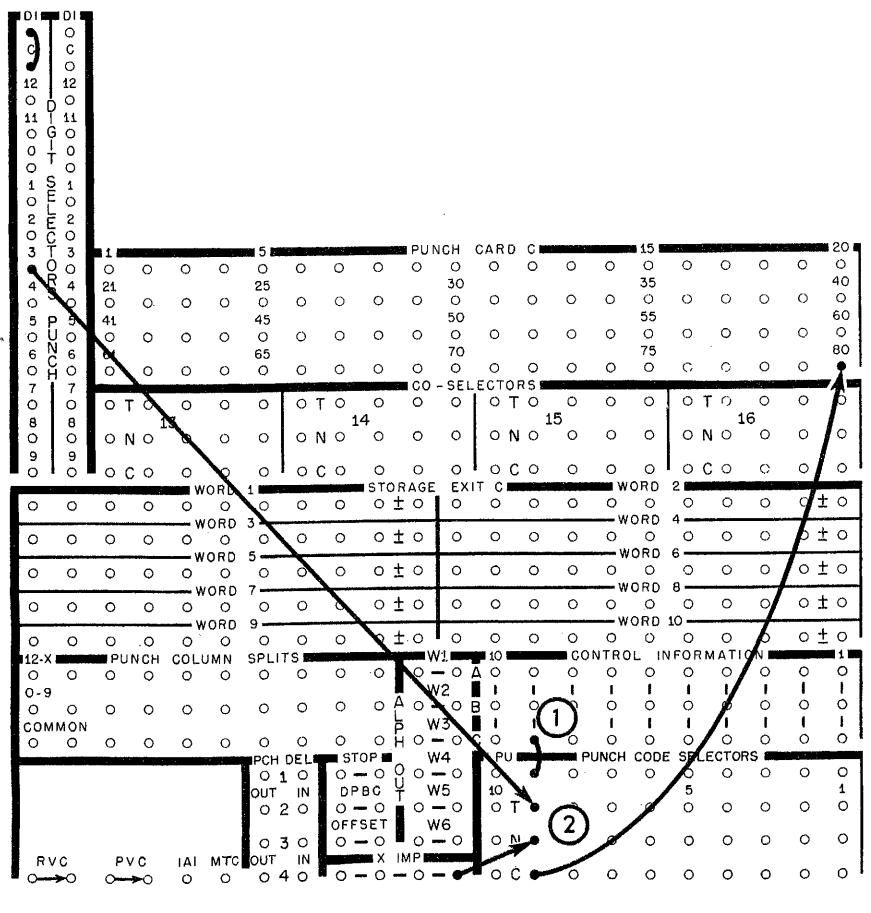

Figure 52. Punch Code Selectors

Index

Alphabetic and Special Character Devices	21
Auxiliary Alphabetic Unit (654)	30
Checking Features	9
Checking Lights	18
Console Operation	12
Control Keys	20
Controlled Stopping	14
Displaying Information	12
Entering Information	14
Error Sensing and Stopping	19
Functional Configuration	1
General Information	1
Half Cycling	15
Half Time Emitter	41
Offset Stacking Device	41
Operating Lights	18
Overflow Sensing and Stopping	19
Power Control	12
Punch Code Selectors	43
Read Code Selectors	42
Special Devices	21
Starting the Program	14
Unit Configuration	2

