



5394 Remote Control Unit

GA27-3852-01

**User's Guide**

Release 1 and Release 2

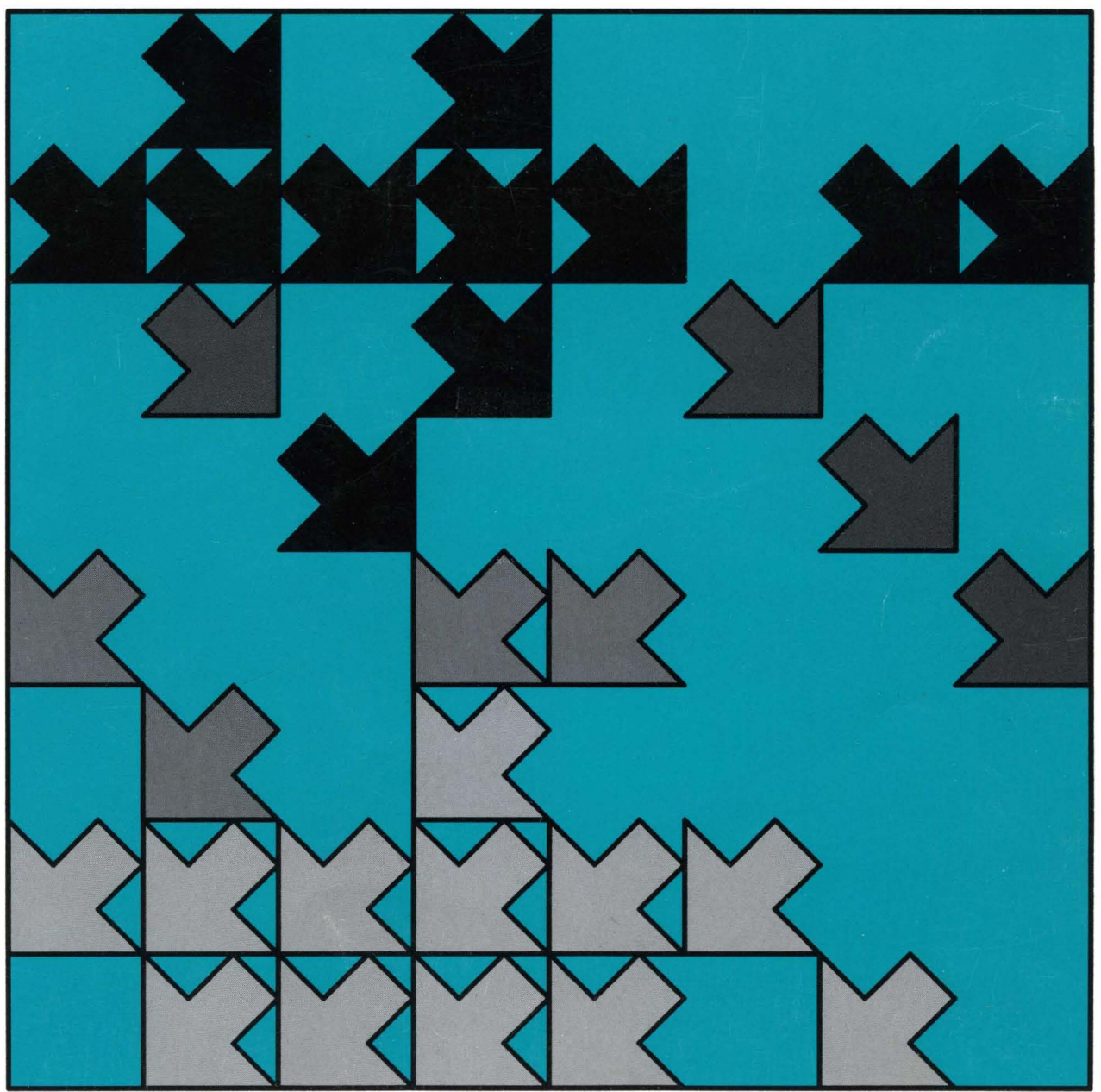



---

5394 Remote Control Unit

GA27-3852-01

**User's Guide**

Release 1 and Release 2

---

---

U.S. English	You can find translated safety notices in the multilingual safety notice book, GA27-3823.
Belgian Dutch	De vertaalde veiligheidsinstructies vindt u in het meertalige boekje GA27-3823.
Canadian French	Vous trouverez les consignes de sécurité en français dans le manuel multilingue GA27-3823.
Danish	Oversatte sikkerhedsbestemmelser kan findes i den flersprogede sikkerhedsbog, GA27-3823.
Finnish	Turvaohjeet ovat myös suomeksi monikielisessä julkaisussa, GA27-3823.
French	Vous trouverez les consignes de sécurité traduites dans la brochure multilingue <i>Safety Notice Book</i> , GA27-3823.
German	Übersetzte Sicherheitshinweise sind dem mehrsprachigen Safety Notice Book, IBM Form GA27-3823, zu entnehmen.
Italian	Le informazioni di sicurezza tradotte si trovano nel manuale: 5394 Unité di controllo remota - Informazioni di sicurezza, GA27-3823.
Japanese	日本語の「安全に関するご案内」は各国語に翻訳された安全に関する記述を一冊にまとめた にありますのでご参照ください。 GA27-3823.
Norwegian	Du finner oversatte sikkerhetsmeldinger i den flerspråklige sikkerhetsboken GA27-3823.
Portuguese	As informações de segurança traduzidas estão incluídas no Manual de Indicações de Segurança GA27-3823 (multilingue).
Spanish	Puede hallar la información sobre seguridad traducida en el manual multilingüe correspondiente, GA27-3823.
Swedish	Svenska översättningar av de varningstexter som riktar sig till användaren finns i det flerspråkiga dokumentet med nummer GA27-3823.

## Second Edition (September, 1990)

Use this publication only for the purposes stated in "About This Book."

References in this publication to IBM products, programs, or services do not imply that IBM intends to make these available in all countries in which IBM operates.

Publications are not stocked at the address given below. Requests for IBM publications should be made to your IBM representative or to the IBM branch office servicing your locality.

This publication could contain technical inaccuracies or typographical errors. A form for readers' comments is provided at the back of this publication. If the form has been removed, comments may be addressed to IBM Corporation, Information Development, Department E02, P.O. Box 12195, Research Triangle Park, North Carolina, U.S.A., 27709-2195. IBM may use or distribute whatever information you supply in any way it believes appropriate without incurring any obligation to you.

The following warning statements (required by country regulatory agencies) are applicable in the countries indicated.

## **United States**

### **Federal Communication Commission (FCC) Statement**

**Warning:** This equipment generates, uses, and can radiate radio frequency energy and if not installed and used in accordance with the instruction manual, may cause interference to radio communication. It has been tested and found to comply with the limits for a Class A computing device pursuant to Subpart J of Part 15 of FCC Rules, which are designed to provide reasonable protection against such interference when operated in a commercial environment. Operation of this equipment in a residential area is likely to cause interference in which case the user at his own expense will be required to take whatever measures may be required to correct the interference.

**Instructions to User:** Properly shielded and grounded cables and connectors must be used for connection to peripherals in order to meet FCC emission limits. Proper cables are available from IBM authorized dealers. IBM is not responsible for any radio or television interference caused by using other than the recommended cables or by unauthorized modifications to this equipment. It is the responsibility of the user to correct such interference.

### **CAUTION:**

**This product is equipped with a 3-wire power cord and plug for the user's safety. Use this power cord in conjunction with a properly grounded electrical outlet to avoid electrical shock.**

## **United Kingdom**

**Warning:** This IBM product is made to high Safety standards. It complies inherently with Telecommunication safety standards. It is not designed to provide protection from excessive voltages appearing externally at its interfaces. Therefore, when this product is connected to a public telecommunication network via any other equipment, and you connect to this product items not supplied by IBM United Kingdom Ltd., you must comply with mandatory telecommunication safety requirements.

You may do this either by choosing products which also are approved as complying to BS6301 or British Telecom Technical Guide No. 26, or by the use of approved safety barriers. Consult the local office of your public telecommunication operator, for advice and permission to make the connections.

## **Far East**

This equipment is Class 1 Equipment (information equipment to be used in commercial and industrial districts) which is in conformance with the standard set by Voluntary Control for Interference by Data Processing Equipment and Electronic Office Machines (VCCI) with an aim to prevent radio interference in commercial and industrial districts.

This equipment could cause interference to radio and television receivers when used in and around residential districts.

Please handle the equipment properly according to the instruction manual.

## **Canada**

This equipment does not exceed Class A limits per radio noise emissions for digital apparatus, set out in the Radio Interference Regulation of the Canadian Department of Communication. Operation in a residential area may cause unacceptable interference to radio and TV reception requiring the owner or operator to take whatever steps are necessary to correct the interference.

Cet équipement ne dépasse pas les limites de Classe A d'émission de bruits radioélectriques pour les appareils numériques, telles que prescrites par le Règlement sur le brouillage radioélectrique établi par le ministère des Communication du Canada. L'exploitation faite en milieu résidentiel peut entraîner le brouillage des réceptions radio et télé, ce qui obligerait le propriétaire ou l'opérateur à prendre les dispositions nécessaires pour en éliminer les causes.

---

## About This Book

This book explains how to set up, configure, and operate the IBM 5394 Remote Control Unit. Use this book to learn how to:

- Set up the control unit
- Attach work stations
- Configure the remote installation
- Operate the control unit from a display station
- Establish and end communication with the host system from a display station
- Isolate and solve problems.

---

## Who Should Read This Book

Chapter 1 through Chapter 5 are for the person who sets up and configures the IBM 5394. The rest of the book is for IBM 5394 operators. Operators must know how to operate at least one of the display stations listed in "Supported Work Stations" on page 3.

---

## How This Book Is Organized

**Chapter 1, Introducing the IBM 5394 Remote Control Unit** — This chapter describes the IBM 5394 Remote Control Unit and provides a list of supported devices.

**Chapter 2, Setting Up the Work Stations** — This chapter explains how to set up and cable your work stations.

**Chapter 3, Setting Up the IBM 5394** — This chapter describes switches and indicators on the IBM 5394 and explains how to set up the control unit.

**Chapter 4, Configuring Your System** — This chapter explains how to enter your control unit configuration information.

**Chapter 5, Connecting Your Communication Line** — This chapter explains how to connect the communication cable to the control unit.

**Chapter 6, Communicating with Your Host System** — This chapter describes how to establish and end communication with the host system.

**Chapter 7, Using the Problem Determination Procedures** — This chapter contains step-by-step procedures to isolate and solve problems that can occur during operation.

**Chapter 8, Running the Communication Tests** — This chapter describes the verification tests and the extended test routine.

**Appendix A, Preparing the Communication Worksheet** — This appendix contains instructions for completing the Communication Worksheet.

**Appendix B, Preparing the Applications Worksheet** — This appendix contains instructions for completing the Applications Worksheet.

**Appendix C, Worksheets** — This appendix contains blank worksheets.

**Appendix D, Determining Your Communication Mode** — This appendix provides instructions for determining the communication mode your system uses.

**Appendix E, System Reference Codes** — This appendix defines the system reference codes (SRCs) that can appear on the display screen.

**Appendix F, Key Sequences** — This appendix defines the special key sequences used in this book for all supported keyboards.

**Appendix G, Decimal to Hexadecimal Conversion Chart** — This appendix contains a chart that is useful for people who are not familiar with hexadecimal notation.

---

## Associated Publications

- *IBM 5394 Remote Control Unit Introduction and Installation Planning Guide*, SK2T-0316
- *IBM 5394 Remote Control Unit Functions Reference*, SC30-3488
- *IBM 5394 Remote Control Unit Maintenance Library*, SY27-0322

# Contents

<b>Chapter 1. Introducing the IBM 5394 Remote Control Unit</b> .....	1
What Is the IBM 5394 Remote Control Unit? .....	1
Supported Work Stations .....	3
Other Devices .....	4
Supported Modems .....	4
How to Use This Book .....	5
<b>Chapter 2. Setting Up the Work Stations</b> .....	7
Equipment You Need .....	7
Completing the Remote Work Station Setup Worksheet .....	9
Labeling Cables .....	15
Completing the Labels .....	15
Attaching the Labels .....	16
Setting Up the Display Stations and Printers .....	18
<b>Chapter 3. Setting Up the IBM 5394</b> .....	19
The Operator Panel .....	19
Switches .....	19
Operator Panel Indicators .....	20
Diskette Activity Indicator .....	21
AC Power Indicator .....	22
Control Unit Setup .....	22
<b>Chapter 4. Configuring Your System</b> .....	31
Configuring without All Work Stations Attached .....	31
Before You Begin Configuration .....	31
Beginning Configuration .....	32
Completing Configuration for SDLC Communication .....	40
Field 3 (Communication Field) .....	40
Field 8 (V.25 bis Parameters) .....	42
Field P (Printer Port and Station Address) .....	43
Saving Your SDLC Configuration Data .....	43
Completing Configuration for X.25 Communication .....	44
Field 4 (X.25 Subscription Data) .....	44
Field 5 (X.25 Configuration Data) .....	45
Field 6 (X.25 Software Data) .....	46
Field 7 (Retry Parameters) .....	48
Field P (Printer Port and Station Address) .....	48
Saving Your X.25 Configuration Data .....	49
Completing Configuration for X.21 Switched Communication .....	50
Field A (Data Network Identification Field) .....	50
Field B (X.21 Short Hold Mode Retry Parameters) .....	50
Field C (Optional Call Progress Signals) .....	51
Field P (Printer Port and Station Address) .....	51
Saving Your X.21 Switched Configuration Data .....	52
Configuring Additional Work Stations .....	52
Copying Configuration Information to New System Diskettes .....	55
Problem Checklist .....	57
<b>Chapter 5. Connecting Your Communication Line</b> .....	59
<b>Chapter 6. Communicating with Your Host System</b> .....	63



Before You Establish Communication .....	64
Establishing Communication with the Host System .....	65
Establishing Communication in SDLC Mode .....	65
Establishing Communication in X.25 Mode .....	70
Establishing Communication in X.21 Switched Mode .....	71
Changing Subscription Parameters .....	73
Ending Communication .....	74
Repackaging, Moving, and Storing the IBM 5394 .....	75
Repackaging and Moving .....	75
Storing .....	75
<b>Chapter 7. Using the Problem Determination Procedures .....</b>	<b>77</b>
Problem Determination Procedures .....	78
Problem Determination Flowchart .....	91
<b>Chapter 8. Running the Communication Tests .....</b>	<b>97</b>
Running the Verification Tests .....	97
Running the EIA 232D or X.21 Switched Extended Test Routine .....	99
Running the V.35 Extended Test Routine .....	107
<b>Appendix A. Preparing the Communication Worksheet .....</b>	<b>115</b>
SDLC Communication Worksheet .....	116
SDLC Communication Worksheet Example .....	116
Instructions for Completing the SDLC Communication Worksheet .....	117
X.25 Communication Worksheet .....	119
X.25 Communication Worksheet Example .....	119
Instructions for Completing the X.25 Communication Worksheet .....	121
X.21 Switched Communication Worksheet .....	124
X.21 Switched Communication Worksheet Example .....	124
Instructions for Completing the X.21 Switched Communication Worksheet .....	125
<b>Appendix B. Preparing the Applications Worksheet .....</b>	<b>127</b>
SDLC Communication .....	129
X.25 Communication .....	130
PVC .....	130
SVC Answer at the IBM 5394 .....	132
SVC Call at the IBM 5394 .....	134
X.21 Switched Communication .....	137
X.21 Direct Call .....	137
X.21 Address Call .....	137
X.21 Answer .....	137
Changing Subscription Parameters .....	137
<b>Appendix C. Worksheets .....</b>	<b>139</b>
<b>Appendix D. Determining Your Communication Mode .....</b>	<b>151</b>
<b>Appendix E. System Reference Codes .....</b>	<b>153</b>
Determining Code Range .....	153
Operator Entry System Reference Codes .....	156
Communication Network System Reference Codes .....	161
Ideographic Support System Reference Codes .....	166
Bidirectional Support System Reference Codes .....	167
Text Entry Assist System Reference Codes .....	168
Customer Setup System Reference Codes .....	169
Host Support System Reference Codes .....	170

X.25 Operator System Reference Codes	171
X.25 Communication System Reference Codes	175
1100ff or 1180ff System Reference Codes	175
1200ff or 1280ff System Reference Codes	179
18ccdd, 19ccdd, and 1Accdd System Reference Codes	181
1Bcc00 System Reference Codes	187
X.21 Switched Operator System Reference Codes	187
X.21 Switched Communication System Reference Codes	188
V.25 bis Operator System Reference Codes	192
V.25 bis Call Indication System Reference Codes	193
V.25 bis Circuit-Terminating System Reference Codes	193
Diskette Drive and Diskette System Reference Codes	194
Microcode Change System Reference Codes	195
Copy-to-Printer and Local Copy System Reference Codes	195
Power-On Sequence System Reference Codes	196
<b>Appendix F. Key Sequences</b>	<b>197</b>
IBM Typewriter Keyboard	198
IBM Typewriter Data Entry Keyboard	199
IBM 122-Key Keyboard	200
IBM Enhanced (102-Key) Keyboard	201
IBM PC, PC XT, and Portable PC Keyboard	202
IBM Personal Computer AT Keyboard	203
IBM Personal System/2 Keyboard (using IBM System 36/38 Work Station Emulation Program)	204
<b>Appendix G. Decimal to Hexadecimal Conversion Chart</b>	<b>205</b>
<b>Appendix H. Ordering Replacement System Diskettes</b>	<b>207</b>
<b>List of Abbreviations and Acronyms</b>	<b>209</b>
<b>Glossary</b>	<b>211</b>
<b>Index</b>	<b>217</b>



---

## Special Notices

References in this publication to IBM products, programs, or services do not imply that IBM intends to make these available in all countries in which IBM operates. Any reference to an IBM product, program, or service is not intended to state or imply that only IBM's product, program, or service may be used. Any functionally equivalent product, program, or service which does not infringe any of IBM's intellectual property rights or other legally protectible rights may be used instead of the IBM product, program, or service. Evaluation and verification of operation in conjunction with other products, except those expressly designated by IBM, are the user's responsibility.

IBM may have patents or pending patent applications covering subject matter in this document. The furnishing of this document does not give you any license to these patents. You can send license inquiries, in writing, to the IBM Director of Commercial Relations, IBM Corporation, Purchase, NY 10577.

The following terms, denoted by an asterisk (\*) in this publication, are trademarks of the IBM Corporation in the United States and/or other countries:

- AS/400
- IBM
- InfoWindow
- OS/2
- PC AT
- Personal System/2.

The following term, denoted by a double asterisk (\*\*) in this publication, is a trademark of another company as follows:

- Telenet      Telenet Communication Corporation.



---

# Summary of Changes

## **Summary of Changes for GA27-3852-01 Release 2.2**

This edition contains information for IBM 5394 Remote Control Units using Release 1, Release 2, Release 2.1, or Release 2.2 system diskettes. You must have a Release 2.2 system diskette to use Release 2.2 functions. Information that applies only to Release 2.2 is noted in the text.

Stage 2 control units (serial number 55000 or above in North America, South America, Australia, and the Far East, or 77001-BE or above in Europe, the Middle East, and Africa) require diskette release level 2.1 or later.

Information was added for enhanced bidirectional support for NLS.

Technical changes or additions to other parts of the book are indicated by a vertical line to the left of the change.

## **Summary of Changes for GA27-3852-00 Release 2**

This *IBM 5394 Remote Control Unit User's Guide* combines the *IBM 5394 Remote Control Unit Setup Guide* and the *IBM 5394 Remote Control Unit Operator's Guide and Problem Determination Procedures*.

This edition contains information for IBM 5394 Remote Control Units using either Release 1 or Release 2 system diskettes. You must have a Release 2 system diskette to use the Release 2 functions. Information that applies only to Release 2 is noted in the text.

Information was added for:

- Preparing the communication and setup worksheets
- V.25 bis auto-dial
- V.35 communication
- X.25 SVC auto-answer
- Copy-to-printer.



---

## Chapter 1. Introducing the IBM 5394 Remote Control Unit

This chapter introduces the IBM\* 5394 Remote Control Unit, lists supported devices, and tells you about the tasks you will complete in this book.

---

### What Is the IBM 5394 Remote Control Unit?

The IBM 5394 Remote Control Unit is a work station control unit and communication unit for remote attachment of multiple display stations and printers. The control unit connects a cluster of work stations (display stations and printers) to a host system through a data communication network for online interactive operations.

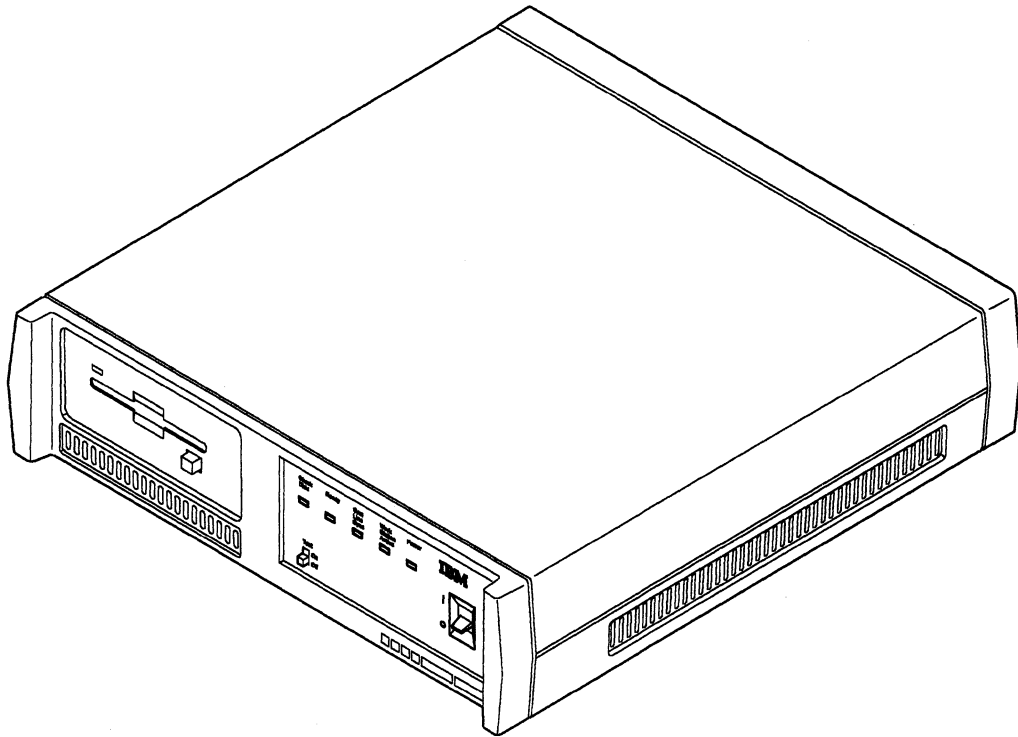



The IBM 5394 features a 3.5-inch diskette drive used to load software that handles communication, work station management, text editing functions, and customer setup. Switches on the operator panel control the operation of the control unit. Indicator lights on the panel inform the operator of the control unit status. "The Operator Panel" on page 19 explains the meaning of the switches and indicators.

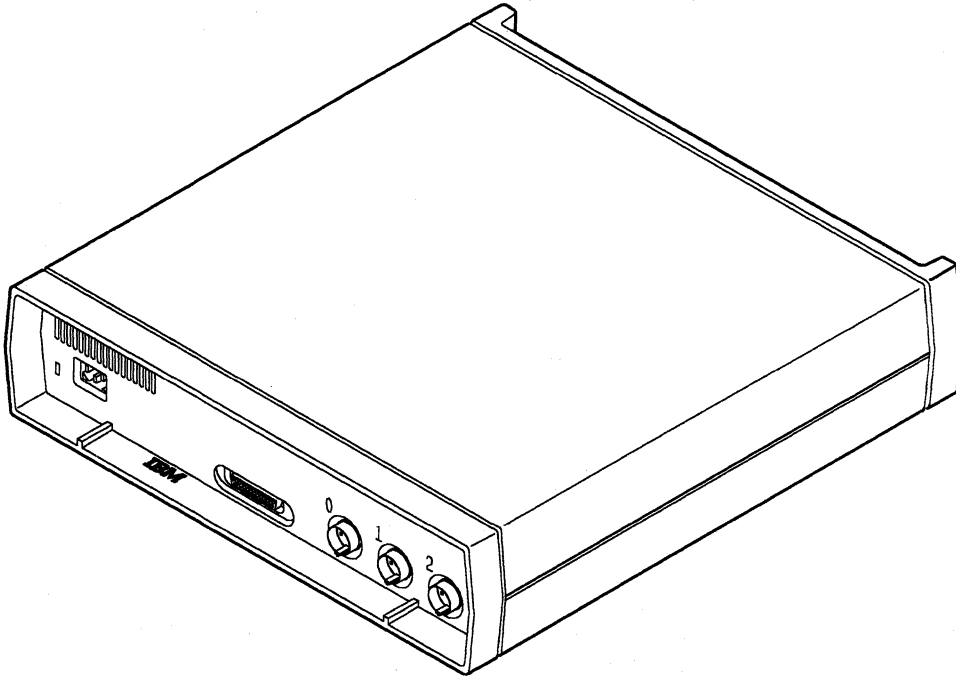

The IBM 5394 has three twinaxial ports. The control unit can support up to 16 work stations with a maximum of seven work stations attached to any port. The IBM 5394 supports communication with a host system through both analog and digital communication networks. The host system can be an IBM System/36, System/38, or AS/400\* system.

---

## Supported Work Stations

You can attach the following twinaxial work stations to the IBM 5394:

- IBM 3179 Color Display Station Model 2
- IBM 3180 Display Station Model 2
- IBM 3196 Display Station Models A10, A20, B10, and B20
- IBM 3197 Display Station Models C10, C20, D10, D20, D40, W10, and W20
- IBM InfoWindow<sup>1</sup> 3476 Models A10, A20, B10, B20, EAx<sup>1</sup>, and EGx
- IBM InfoWindow 3477 Models C1x<sup>2</sup>, C2x, D1x, D2x, E1x, E2x, FAx, FCx, FDx, FGx, W1x, and W2x
- IBM 3812 Printer Models 1 and 2
- IBM 3816 Printer Models 01D and 01S
- IBM 4210 Printer Model 1
- IBM 4214 Printer Model 2
- IBM 4224 Printer Models 101, 102, 1C2, 1E2, and 1E3
- IBM 4234 Printer Models 2 and 012
- IBM 5219 Printer Models D01 and D02
- IBM 5224 Printer Models 1 and 2
- IBM 5225 Printer Models 1, 2, 3, and 4
- IBM 5227 Printer Models 1, 2, 3, and 5
- IBM 5251 Display Station Models 11 and 999
- IBM 5256 Printer Models 1, 2, and 3
- IBM 5262 Printer Model 1
- IBM 5291 Display Station Models 1 and 2
- IBM 5292 Color Display Station Models 1 and 2
- IBM 5295 Display Station Models 1, 2, 0C2, OH2, GP3, and LK1
- IBM 5317 Printer Model 1
- IBM 5327 Printer Models 1, 2, and 3
- IBM 6262 Models T12, T14, and T22
- IBM PC with Enhanced 5250 Emulation Program (Models 5150, 5155, 5160, 5162, and 5170)
- IBM PC AT<sup>1</sup> using OS/2<sup>1</sup> Extended Edition 1.2 (Model 5170)
- IBM Personal System/2<sup>1</sup> using OS/2 Extended Edition 1.2 (Models 8530, 8550, 8555, 8560, 8565, 8570, 8573, and 8580)
- IBM Personal System/2 with Enhanced 5250 Emulation Program (Models 8525 and 8530)
- IBM Personal System/2 with IBM System 36/38 Work Station Emulation Program (Models 8550, 8560, and 8580)
- IBM PC and Personal System/2 with AS/400 PC Support
- IBM Personal System/55 with IBM Japanese 5250 Personal Computer/2 AD (5250 PC/2 AD) Support
- IBM Personal System/55 with 5250 emulation programs (Models 5530, 5540, 5550, 5560, and 5570).

**Note:** The following display stations cannot be used for customer setup and may not display network error codes:

- IBM PC or Personal System/2 using AS/400 PC Support
- IBM PC AT or Personal System/2 using OS/2 Extended Edition 1.2
- IBM Personal System/55 using 5250 PC/2 AD Support.

---

1 The x in these model numbers can be 1 or 3.

2 The x in these model numbers can be any number.

Some displays and PC, PS/2, and PS/55 programs that are supported by the IBM 5394 can also emulate a 5250 printer session using a display, PC, PS/2, or PS/55 attached printer. Refer to the documentation for these products to find out which printers they support.

All IBM 5394 models support the following work station functions:

- National language support
- Selector light pen
- DisplayWrite
- Magnetic stripe reader
- IBM 5294 Emulation
- Self-check
- Copy-to-printer.

---

## Other Devices

The IBM 5394 also supports the following devices:

- IBM 5208 (ASCII-5250) Line Protocol Converter
- IBM 5209 (3270-5250) Line Protocol Converter
- IBM 5299 Model 3 Terminal Multiconnector
- ROLMbridge 5250 Line Protocol Converter Model 46815B
- IBM 7820 ISDN Terminal Adapter.

---

## Supported Modems

The IBM 5394 supports the following IBM modems:

- IBM 3833 Model 1
- IBM 3834 Model 1
- IBM 3863 Models 1 and 2
- IBM 3864 Models 1 and 2
- IBM 3865 Models 1 and 2
- IBM 3868 Models 1, 2, 3, and 4
- IBM 3872 Model 1
- IBM 3874
- IBM 3875
- IBM 5811 Models 10, 18, 20, and 28
- IBM 5812 Models 10 and 18
- IBM 5821 Model 10
- IBM 5822 Model 10
- IBM 5842 Model 1
- IBM 5853 Model 1
- IBM 5865 Models 1, 2, and 3
- IBM 5866 Models 1, 2, and 3
- IBM 5868 Models 51, 52, 61, and 62
- IBM 7861
- IBM 7868.

---

## How to Use This Book

You can find the instructions you need in this book to:

- Complete worksheets to help you set up and configure your system
- Cable your work stations
- Set up and cable the IBM 5394
- Configure your system
- Connect the communication line
- Establish and end communication with the host system
- Isolate control unit problems
- Run communication tests.

If you are setting up and configuring your system, you can find the instructions you need in the following chapters:

- Chapter 2, Setting Up the Work Stations
- Chapter 3, Setting Up the IBM 5394
- Chapter 4, Configuring Your System
- Chapter 5, Connecting Your Communication Line.

If you are establishing daily communication with your host system, you can find the procedures in Chapter 6, Communicating with Your Host System.

If a problem occurs while you are operating the IBM 5394, you can isolate the problem using the instructions in Chapter 7, Using the Problem Determination Procedures.

If the problem determination procedures direct you to run a communication test, you can find the test procedures in Chapter 8, Running the Communication Tests.

If a system reference code (SRC) appears on your screen at any time, you can find its meaning in Appendix E, System Reference Codes.



---

## Chapter 2. Setting Up the Work Stations

This chapter tells you how to prepare your display stations and printers for attachment to the IBM 5394. You can complete the following tasks using the information in this chapter:

- Complete the Remote Work Station Setup Worksheets. These worksheets provide specific information about the work stations attached to your IBM 5394 and show how your remote installation is configured.
- Prepare and attach cable labels.
- Set up and cable the work stations.

You should have your work station setup books available for specific information on unpacking and terminating your work stations and setting work station addresses.

---

### Equipment You Need

Before you begin, make sure that you have all of the equipment shown here. You need the following equipment to set up your remote installation:

- IBM 5394 Remote Control Unit
- Work stations
- Modem or DCE
- Power cord
- Communication interface cable
- Communication Worksheet (Get this worksheet from your planner or see Appendix A, "Preparing the Communication Worksheet" on page 115.)
- Work station cables
- Labels for work station cables
- IBM 5394 system diskette and backup system diskette.

See illustrations on the following page.

**Warning:** Do not stack another 5394 or any electrical equipment directly on top of the IBM 5394. This could result in intermittent errors during operation.

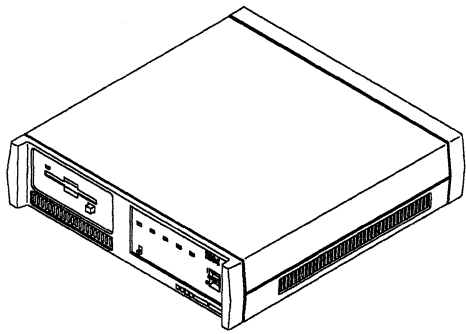

IBM 5394 Remote Control Unit

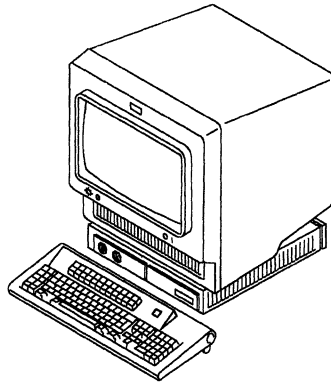

Work Station

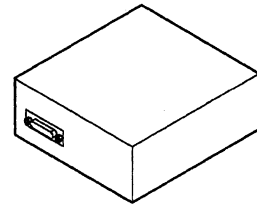

Modem or DCE

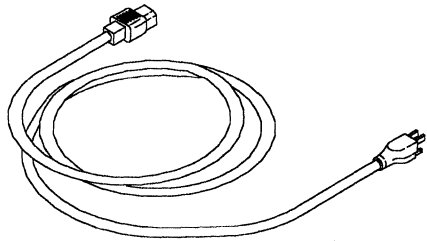

Power Cord

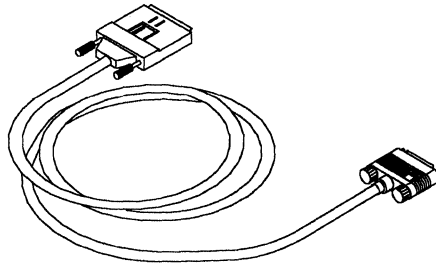

Communication Interface Cable

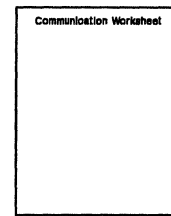

Communication Worksheet

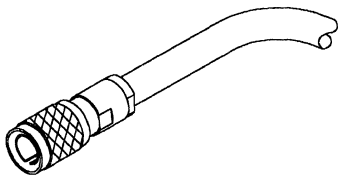

Work Station Cable

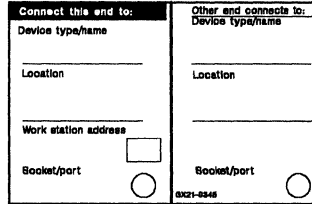

Cable Label

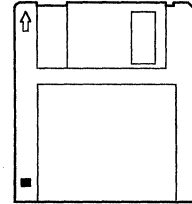

System Diskette

---

## Completing the Remote Work Station Setup Worksheet

Before completing this worksheet, you need a floor plan of your site showing work station placement and cabling. The following floor plan shows the cabling for port 1 and is used as an example in this chapter.

Refer to *IBM 5394 Remote Control Unit Introduction and Installation Planning Guide* for a description of how to create a floor plan.



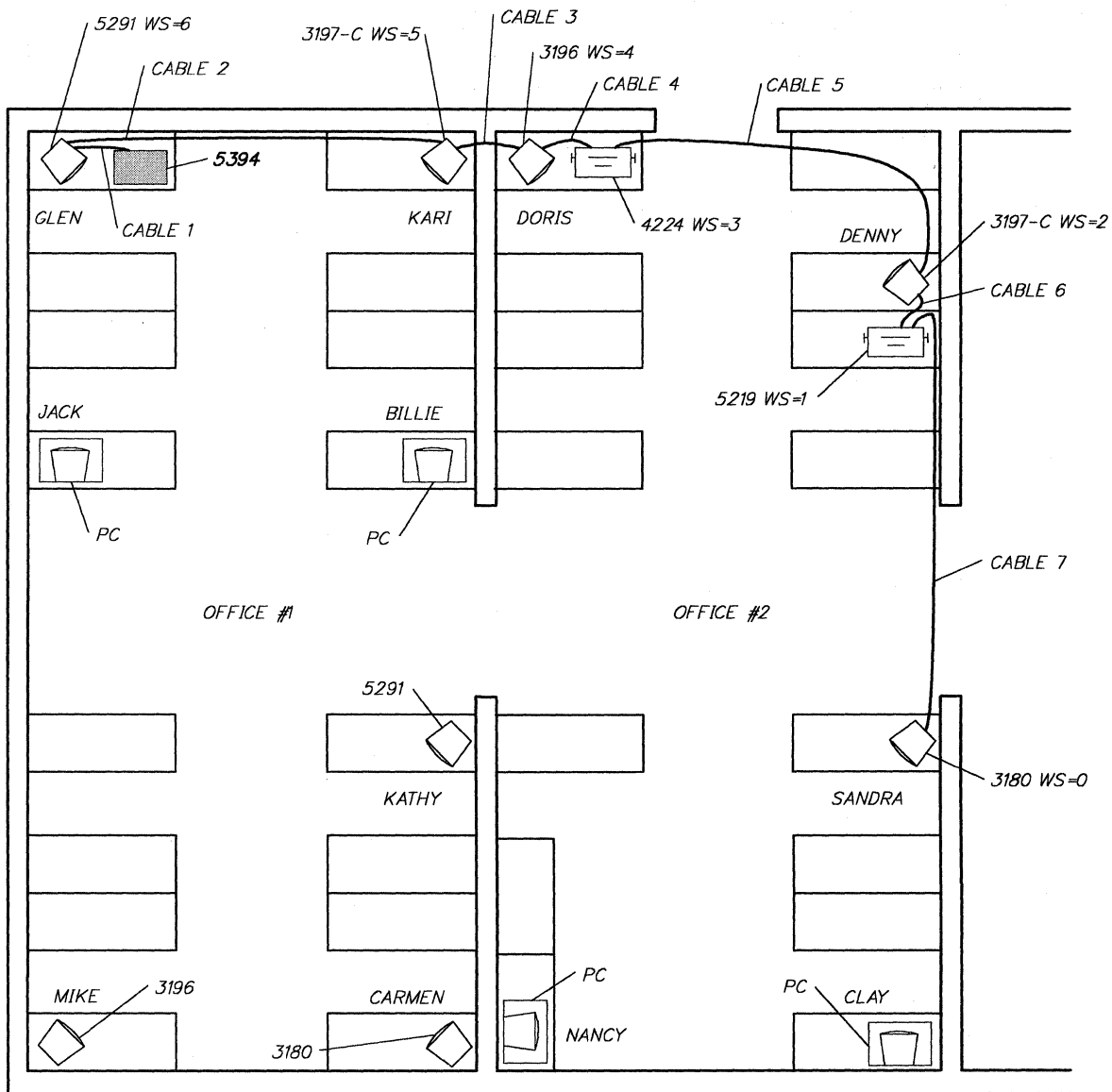

SCHEDULE OF CABLES-PORT 1	
CABLE 1	4'-0"
CABLE 2	17'-0"
CABLE 3	6'-6"
CABLE 4	3'-0"
CABLE 5	18'-6"
CABLE 6	3'-0"
CABLE 7	20'-6"

Make several copies of the blank Remote Work Station Setup Worksheet in Appendix C, "Worksheets" on page 139. Complete a separate worksheet for each port of each control unit.

Refer to the following sample worksheets as you read these instructions. The first example shows a configuration of seven work stations attached to port 1 of the IBM

5394. The second example shows seven work stations attached to the IBM 5394 through an IBM 5299 Terminal Multiconnector.

### IBM 5394 Remote Work Station Setup Worksheet

#### EXAMPLE

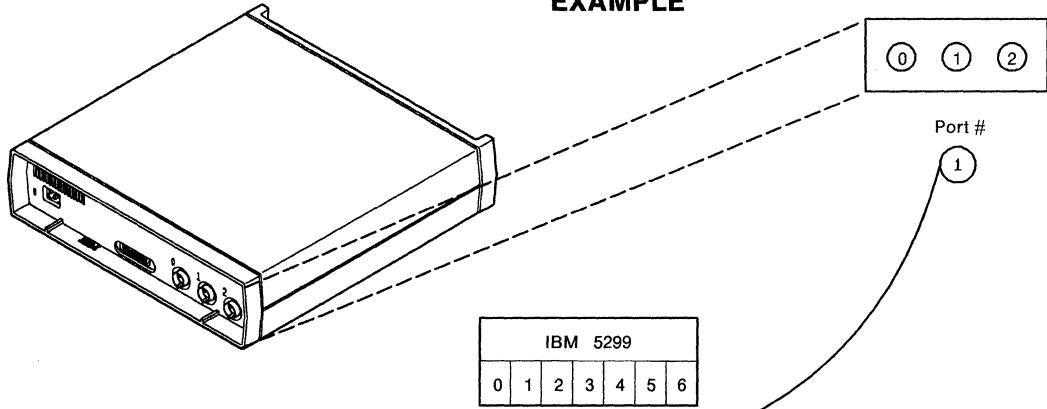

Name	<i>Glen</i>	Socket 1
Device Type	5291	
Location	<i>Accounting</i>	
Work Station Address	6	
Unit Address	0D	
Keyboard Code	00	
Telephone		Socket 2

Name	<i>Kari</i>	Socket 1
Device Type	3197-C	
Location	<i>Accounting</i>	
Work Station Address	5	
Unit Address	0C	
Keyboard Code	00	
Telephone		Socket 2

Name	<i>Doris</i>	Socket 1
Device Type	3196	
Location	<i>Sales</i>	
Work Station Address	4	
Unit Address	0B	
Keyboard Code	00	
Telephone		Socket 2

Name	<i>Doris</i>	Socket 1
Device Type	4224	
Location	<i>Sales</i>	
Work Station Address	3	
Unit Address	0A	
Keyboard Code	<i>None</i>	
Telephone		Socket 2

Socket 1	Name	<i>Denny</i>
	Device Type	3197-C
	Location	<i>Accounting</i>
	Work Station Address	2
	Unit Address	09
	Keyboard Code	00
Socket 2	Telephone	

Socket 1	Name	<i>Denny</i>
	Device Type	5219
	Location	<i>Accounting</i>
	Work Station Address	1
	Unit Address	08
	Keyboard Code	<i>None</i>
Socket 2	Telephone	

Socket 1	Name	<i>Sandra</i>
	Device Type	3180-2
	Location	<i>Accounting</i>
	Work Station Address	0
	Unit Address	07
	Keyboard Code	00
Socket 2	Telephone	

**Note:** Each cable connected to an IBM 5394 Control Unit port should have a tag with a number from 0 through 2. Each port used should have a cable. Connect each cable to the port indicated on its tag.

## IBM 5394 Remote Work Station Setup Worksheet

### EXAMPLE

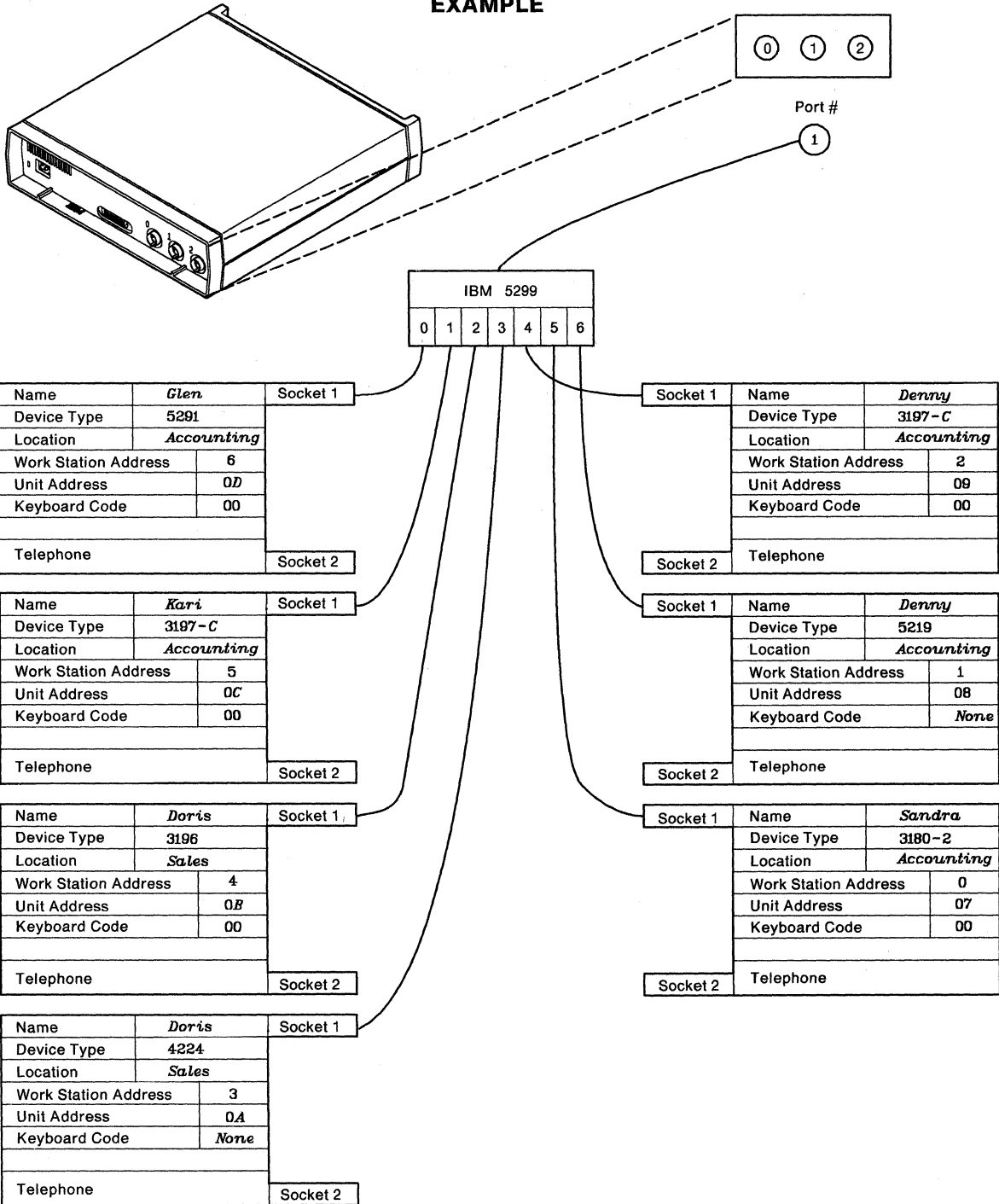

**Note:** Each cable connected to an IBM 5394 Control Unit port should have a tag with a number from 0 through 2. Each port used should have a cable. Connect each cable to the port indicated on its tag.

To complete each worksheet, do the following:

1. Write the number of the port you are configuring in the circle under Port #.
2. Each block on the worksheet represents an attached work station. Refer to your floor plan for the correct cabling sequence, and draw lines indicating the order in which your work stations are attached, as described below:
  - a. Draw a line from the circled port number to "Socket 1" on the first block to indicate the first work station attached to this port.
  - b. Draw another line from "Socket 2" of this first block to "Socket 1" of the next block to indicate the attachment of a second work station.
  - c. Continue drawing lines to indicate the attachment of each work station attached to this port.

**Note:** You can attach up to seven work stations to any port. However, you are limited to a total of four work stations for each IBM 5394 Model 01A or 02A, eight work stations for each Model 01B or 02B connected to an IBM System/36 or System/38, and 16 work stations for each Model 01B or 02B connected to an IBM AS/400 system.

- d. If you are attaching an IBM 5299, draw a line from the circled port number to the IBM 5299 box below it. Then draw lines from each IBM 5299 port to its attached work stations.
3. Fill in a block for each attached work station. Begin with the last block to which a line is drawn. The following instructions will help you fill in the blocks.
  - a. **Name.** Write the name of the person responsible for operating this device.
  - b. **Device Type.** Write the manufacturer's name and model of the device.
  - c. **Location.** Write the department name or location of the device.
  - d. **Work Station Address.** Assign a different address to each work station on a port. For example, if you have three devices on a port, number them 0, 1, and 2.
  - e. **Unit Address.** The unit address is used by the host system to access each device and is part of the host configuration for each device. Use the following table to determine the unit address (local location address on AS/400) for each device. For example, 0D is the unit address for the device at Port 1 and Work Station Address 6. Each device must have its own unique unit address. Notice, however, that some work stations may have the same work station address.

	Work Station Address						
	0	1	2	3	4	5	6
<b>Port 0</b>	00	01	02	03	04	05	06
<b>Port 1</b>	07	08	09	0A	0B	0C	0D
<b>Port 2</b>	0E	0F	10	11	12	13	14

- f. **Keyboard Code.** Use the following table to determine your keyboard code entries. For printers, enter "none" in the space.

Country Character Set	Keyboard Code	Country Character Set	Keyboard Code
Arabic	30	Korea	38
Austria/Germany	20	Netherlands	2D
Austria/Germany multinational	21	Netherlands multinational	2E
Belgium multinational	07	Norway	16
Canada	00	Norway multinational	17
Canada multinational	22	Simplified Chinese	
Canadian French	08	(People's Republic of China)	3A
Canadian French multinational	09	Portugal	18
Cyrillic	31	Portugal multinational	19
Denmark	0A	Latin 2	34
Denmark multinational	0B	Spain	1C
Finland	0C	Spain multinational	1D
Finland multinational	0D	Latin America	0E
France (AZERTY)	04	Latin America multinational	0F
France (AZERTY) multinational	05	Sweden	1E
France (QWERTY)	1A	Sweden multinational	1F
France (QWERTY) multinational	1B	Swiss French multinational	28
Greek	32	Swiss German multinational	2A
Hebrew	33	Traditional Chinese	
Icelandic	2B	(Taiwan)	39
Icelandic multinational	2C	Thai	35
International	14	Turkish	36
International multinational	15	United Kingdom	12
Italy	10	United Kingdom multinational	13
Italy multinational	11	United States	00
Japanese/English multinational	02	United States multinational	22
Japanese/Kanji multinational	37	Yugoslav multinational	2F
Japanese/Katakana multinational	01		
Japanese multinational	03		

**Notes:**

- 1) Make sure all keyboard codes used in your configuration are supported by your host system.
  - 2) If the display stations in your configuration have different keyboard codes, you must select only multinational keyboard codes.
  - 3) The maximum number of multinational keyboard codes that you can select for any configuration is four.
- g. **Telephone.** This is the work station operator's telephone number. This person can report on the operational status of this device and may assist in problem determination.

**The Remote Work Station Setup Worksheet is complete. Go to "Labeling Cables" on page 15 to prepare your cables.**

## Labeling Cables

See your IBM sales representative to order a set of *IBM Labels for Signal Cables*, GX21-9345. If necessary, use the following sample label to produce your own.

Connect this end to:	Other end connects to:
Device type/name	Device type/name
Location	Location
Work station address	
Socket/port	Socket/port

GX21-9345

## Completing the Labels

You should complete two labels for each twinaxial cable that connects to a work station, or control unit. After you complete the labels, attach one label to each end of the cable. These labels will help you set up your work stations and control unit(s). The labels also aid in problem determination.

To complete each label:

- Using a ball-point pen, copy the information from the Remote Work Station Setup Worksheet to the labels.

**Note:** You may also want to include the telephone number for a telephone located at each end of the cable.

For this example, 1 is the work station address of the IBM 3196. (If this end of the cable is to be connected to an IBM 5394, the box should be left blank.)

These indicate the socket number on the IBM 3196 to which the cable will be connected.

Connect this end to:	Other end connects to:
Device type/name <i>IBM 3196</i>	Device type/name <i>IBM 5394</i>
Location <i>Accounting</i>	Location <i>Accounting</i>
Work station address <i>1</i>	
Socket/port <i>1</i>	Socket/port <i>0</i>

GX21-9345

These indicate the port number on the IBM 5394 to which the other end of the cable is connected.

- Complete another label for the other end of the cable.

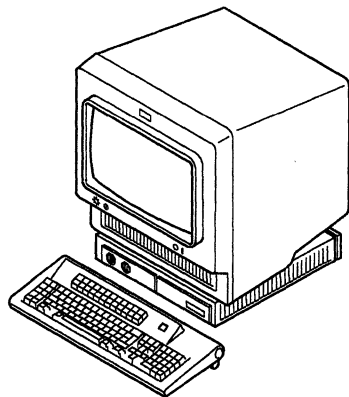

IBM 3196 Display Station

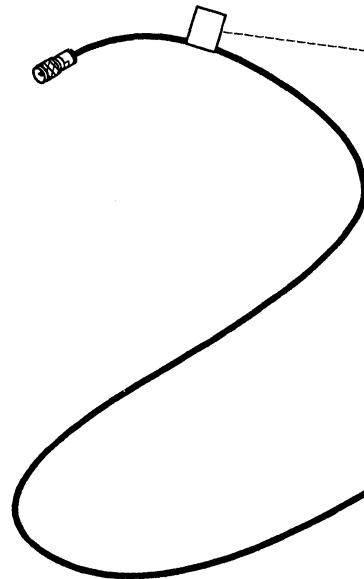

Connect this end to:	Other end connects to:
Device type/name <i>IBM 3196</i>	Device type/name <i>IBM 5394</i>
Location <i>Accounting</i>	Location <i>Accounting</i>
Work station address <i>1</i>	Work station address <i>0</i>
Socket/port <i>1</i>	Socket/port <i>0</i>

GX21-9345

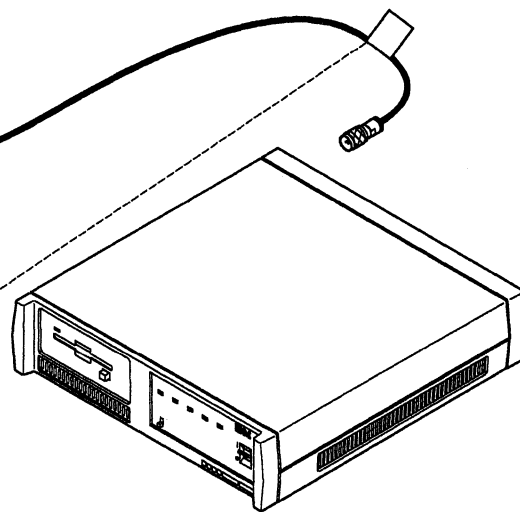

IBM 5394

Connect this end to:	Other end connects to:
Device type/name <i>IBM 5394</i>	Device type/name <i>IBM 3196</i>
Location <i>Accounting</i>	Location <i>Accounting</i>
Work station address <i>0</i>	Work station address <i>1</i>
Socket/port <i>0</i>	Socket/port <i>1</i>

GX21-9345

3. If you connect a cable to a station protector, each end of the cable should have a label attached to it. The label should indicate which device is attached to the station protector.

## Attaching the Labels

After you complete the labels, attach each label to a cable by doing the following:

1. Remove the backing from the label.

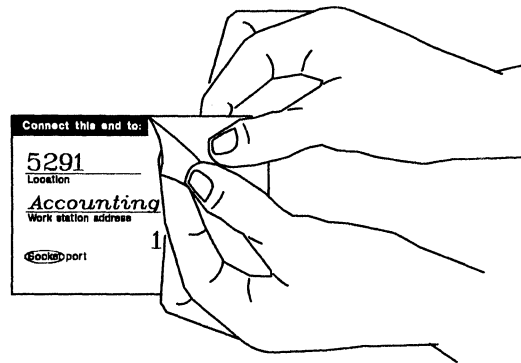

2. Place the label on the cable.

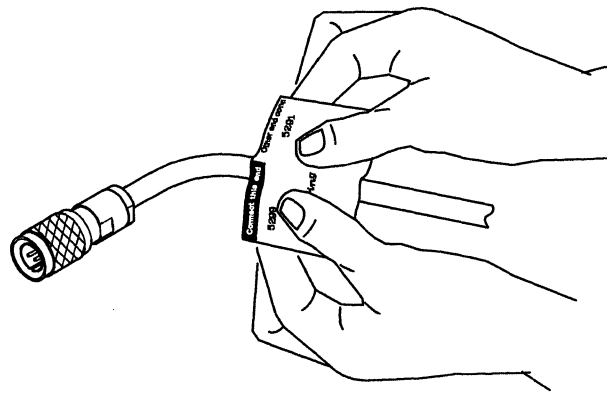

3. Wrap the ends of the label around the cable.

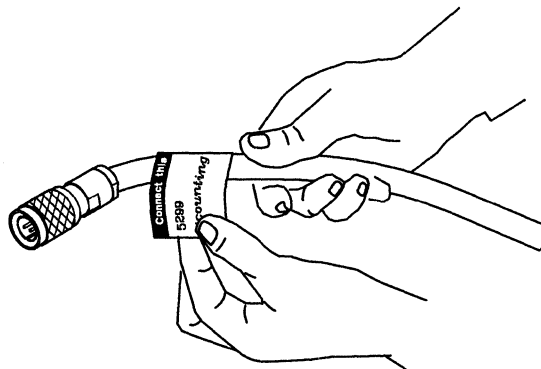

To complete work station setup, go to "Setting Up the Display Stations and Printers" on page 18.



---

## Setting Up the Display Stations and Printers

Before unpacking your work stations, make sure that properly wired and grounded electrical outlets are installed.

Refer to your work station setup books for specific instructions on unpacking and setting up the work stations.

**Step 1** Unpack the work stations and place them in the designated work areas.

**Note:** One display station should be within 6 meters (approximately 20 feet) of the control unit for setup. This display station cannot be any of the following:

- IBM PC or Personal System/2 using AS/400 PC Support
- IBM PC AT or Personal System/2 using OS/2 Extended Edition 1.2
- IBM Personal System/55 using 5250 PC/2 AD Support.

You may use an IBM PC, Personal System/2, or Personal System/55 using a 5250 emulation program.

**Step 2** Route the work station cables according to the Remote Work Station Setup Worksheets or your floor plan.

**Step 3** Set the work station addresses according to the Remote Work Station Setup Worksheets.

**Step 4** Make sure that the work stations are terminated correctly.

**Step 5** Connect the cables to the work stations. Do not connect the cables to the IBM 5394 at this time.

Go to Chapter 3, "Setting Up the IBM 5394" on page 19 for instructions for setting up the IBM 5394.

## Chapter 3. Setting Up the IBM 5394

This chapter explains how to set up the IBM 5394 Remote Control Unit. You can complete the following tasks using the information in this chapter:

- Learn about the IBM 5394 switches and indicators.
- Set up the control unit.
- Cable the work stations to the control unit.

**Warning:** Do not stack another 5394 or any electrical equipment directly on top of the IBM 5394. This could result in intermittent errors during operation.

### The Operator Panel

The following illustration shows the IBM 5394 operator panel.

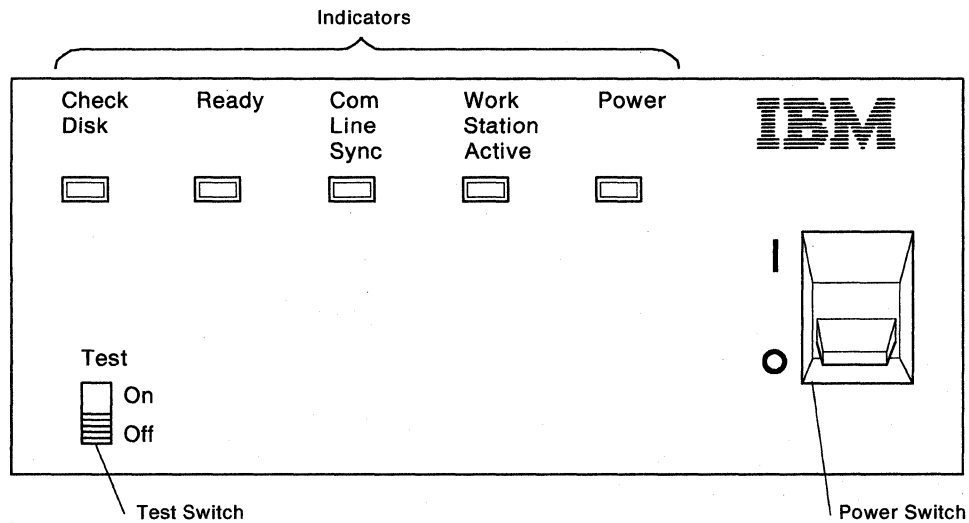

### Switches

The IBM 5394 has two operator panel switches. The switches control the operation of the IBM 5394.

#### Power Switch

The power switch has two positions:

- On (I)
- Off (O).

The power switch connects or disconnects electrical power.

## Test Switch

The Test switch has two positions:

- On

The On position is used for diagnostic and configuration procedures.

- Off

The Off position is used for all other operations.

If the Test switch is in the On position when the power switch is set to on (I), the control unit enters the Customer Setup (CSU) mode. For more information about CSU, see Chapter 4, "Configuring Your System" on page 31.

To return to normal operations, set the control unit power switch to off (O), set the Test switch to Off, and then set the power switch to on (I).

## Operator Panel Indicators

The operator panel has five indicators. All indicators blink on and off when the power switch is set to on (I) and an internal lamp test is running.

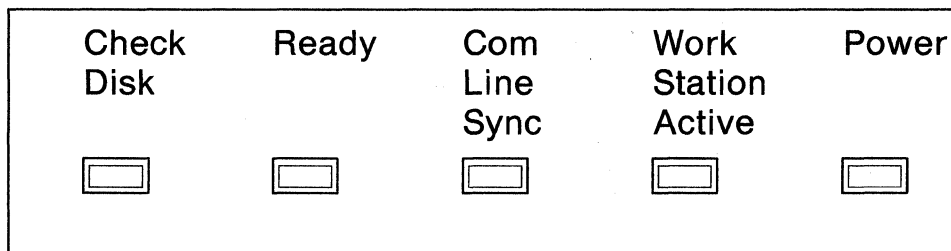

### Check Disk Indicator

The amber Check Disk indicator comes on if a problem is detected in the diskette drive or diskette.

### Ready Indicator

The green Ready indicator comes on after the power-on sequence completes successfully. The Ready indicator blinks if the control unit is failing.

### Com Line Sync Indicator

The green Com Line Sync indicator comes on, and may blink, when the control unit detects activity on the communication line.

### Work Station Active Indicator

The green Work Station Active indicator comes on when the control unit is communicating with at least one work station.

## Power Indicator

The green Power indicator comes on after the power switch is set to on (I). This indicator goes off when the power switch is set to off (O) or when a power failure occurs.

---

## Diskette Activity Indicator

The diskette activity indicator is on the front of the control unit. This indicator comes on when the diskette drive motor is on. The diskette activity indicator is amber. The IBM 5394 system diskette regularly spins up to clear the diskette of any airborne contaminants that may have settled on the diskette surface. The diskette activity indicator comes on during spin-up.

**Note:** The diskette activity indicator may be positioned slightly below the diskette opening.

**Warning:** Do not remove the diskette from the diskette drive or set the control unit power switch to off (O) while the diskette activity indicator is on.

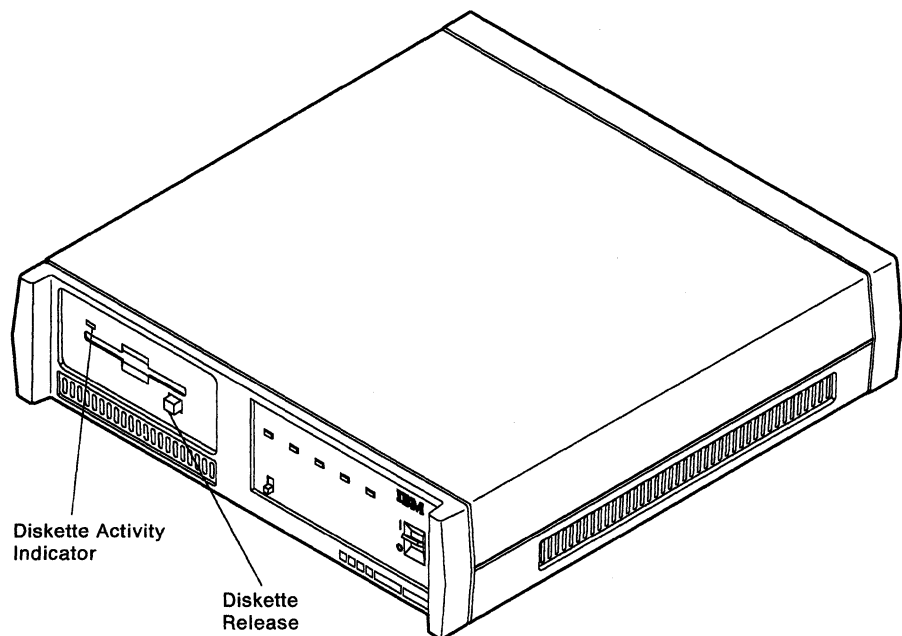

---

## AC Power Indicator

The AC power indicator is on the back of the control unit next to the AC power receptacle. This indicator comes on when AC power is present. The AC power indicator is green.

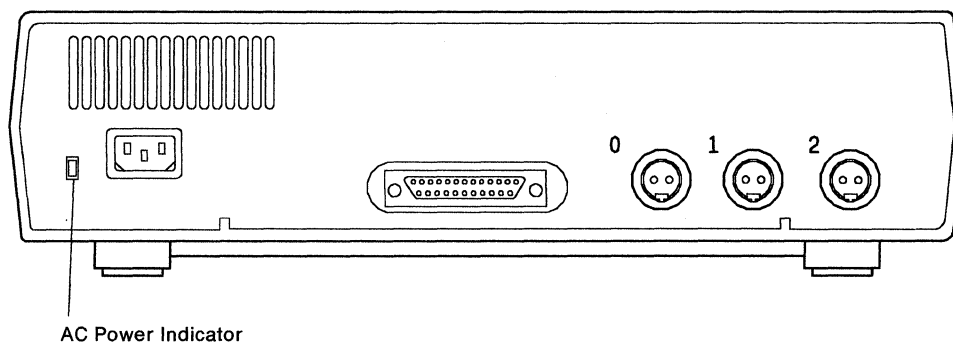

---

## Control Unit Setup

To set up and cable the IBM 5394, do the following:

- Step 1** Set the control unit power switch to off (O).

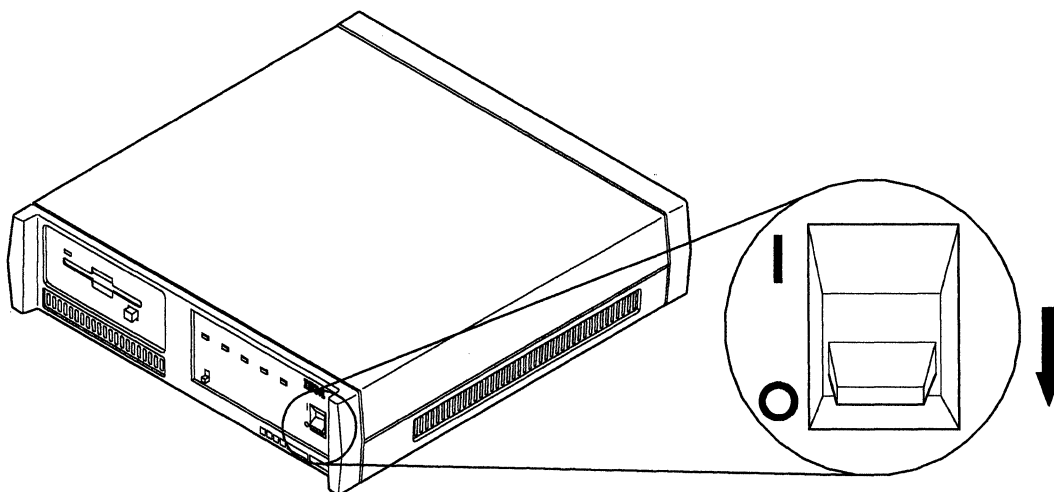

**CAUTION:**

For your safety, you must connect equipment only to a properly wired and grounded outlet. An improperly wired outlet can place hazardous voltage on accessible metal parts of the equipment. The customer is responsible for outlet wiring.

**DANGER**

Never work on equipment, or connect or disconnect signal cables during periods of lightning activity.

- Step 2** Connect the power cord to the power cord receptacle on the back of the control unit. Connect the other end of the power cord to a grounded electrical outlet. (See the following illustration.) Make sure the AC power indicator comes on.

If the AC power indicator does not come on, see Chapter 7, "Using the Problem Determination Procedures" on page 77.

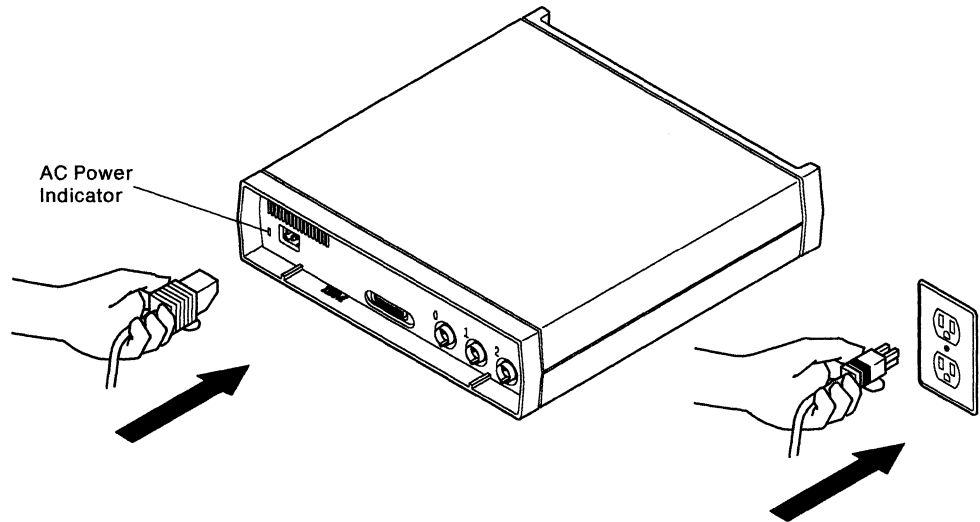

- Step 3** Make sure that the write-protect tab on the system diskette is closed (not write-protected). Insert the system diskette in the IBM 5394 diskette drive at all times unless this book tells you to remove it.

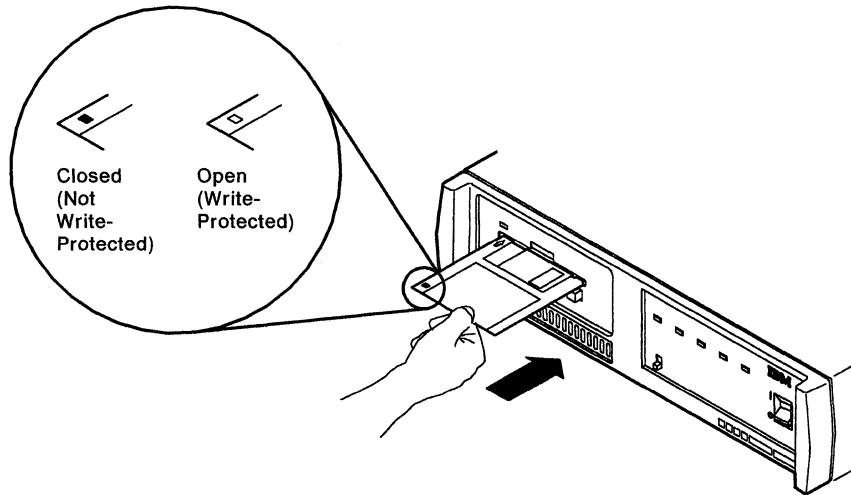

- Step 4** Make sure the Test switch on the control unit is set to Off. Set the control unit power switch to on (I).

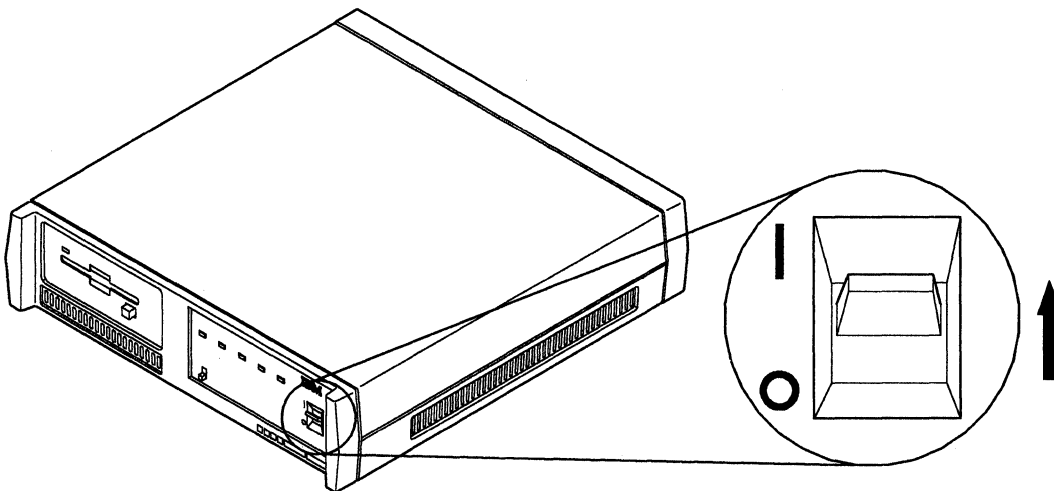

**Step 5** All control unit indicators come on for about 1 second. Then, all indicators except the Power indicator go off. Within 2 minutes, the Ready indicator comes on.

**Warning:** Do not remove the diskette from the diskette drive or set the control unit power switch to off (O) while the diskette activity indicator is on.

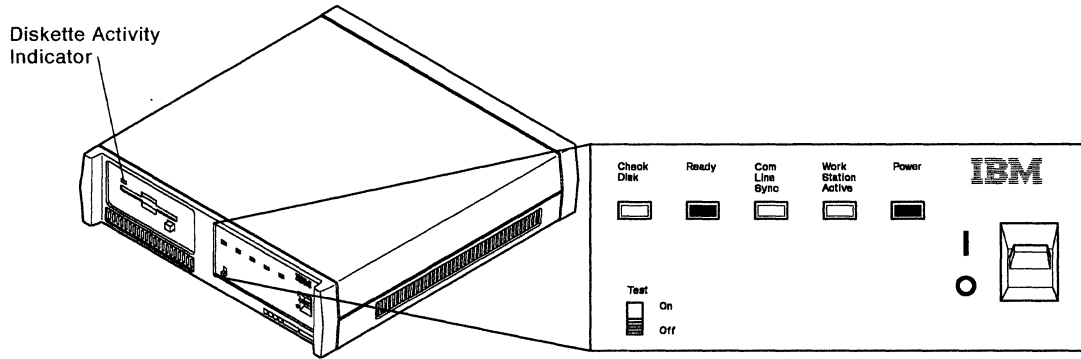

Legend:

 On

 Off

 Blinking

Is the Ready indicator on?

**YES** - Go to step 6.

**NO** - Refer to Chapter 7, "Using the Problem Determination Procedures" on page 77.

**CAUTION:**

**Turn power off and unplug the power cord from the receptacle before connecting or disconnecting signal cables.**

**Step 6** Set the control unit power switch to off (O). Disconnect the control unit power cord from the electrical outlet.

Make sure all cables that will be connected to your control unit are labeled. If they are not, see "Labeling Cables" on page 15.



**Step 7** Find the work station cable that connects to port 0 on the IBM 5394.  
(The twinaxial connectors on the back of the control unit are called ports.)

**Note:** Make sure that the label identifies the IBM 5394 as the device type. See the following example.

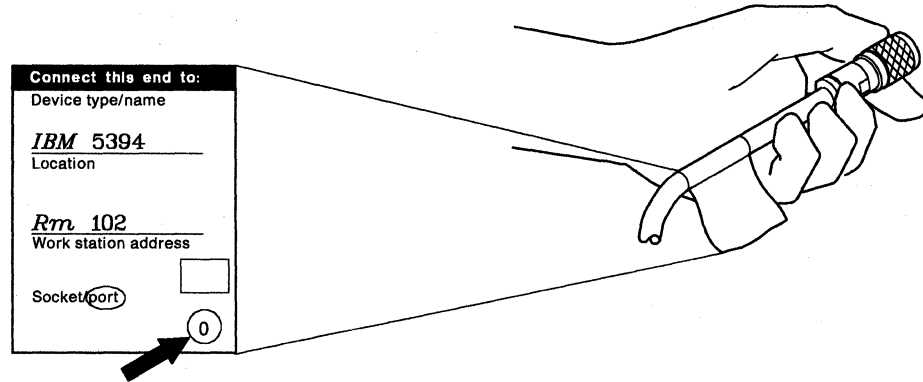

**DANGER**

**Never work on equipment, or connect or disconnect signal cables during periods of lightning activity.**

**Step 8** Align the widest slot in the cable connector with the key in the port.

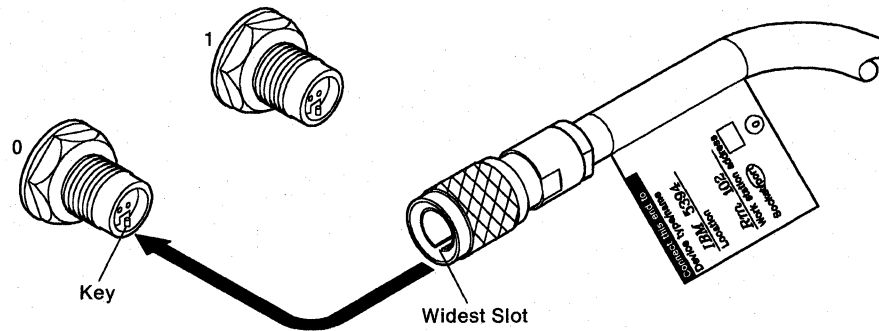

**Step 9** Push the connector in and turn the retaining ring clockwise until it is tight.

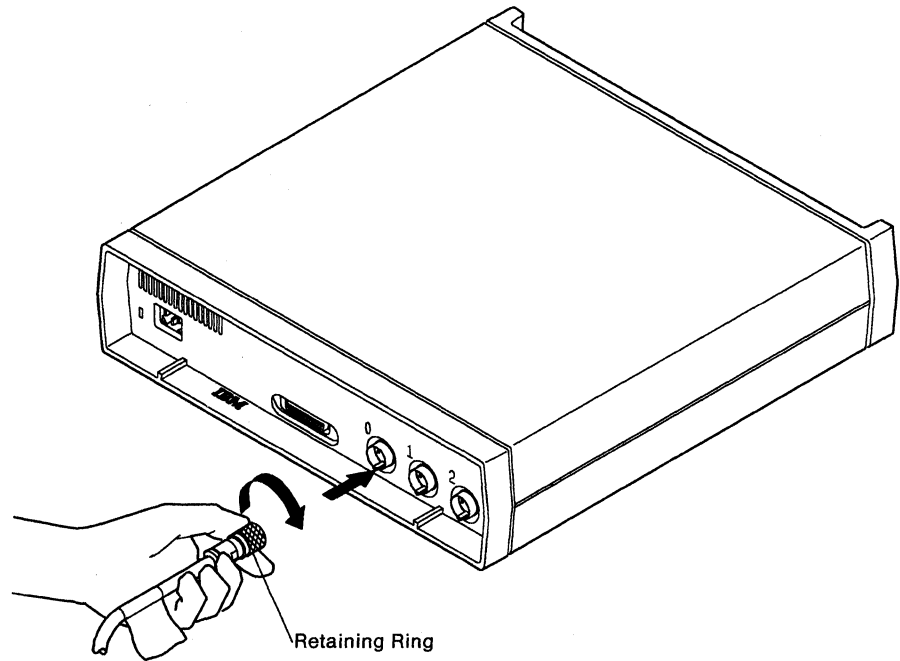

**Step 10** Connect the remaining work station cables (if any) to ports 1 and 2.

**Step 11** Set the power switches on all work stations to on.

**Step 12** Connect the control unit power cord to a grounded electrical outlet.

**Step 13** Set the Test switch to On.

**Step 14** Set the control unit power switch to on (I).

All the indicators come on for about 1 second. Then all the indicators except the Power indicator go off. Within 4 minutes, the Ready and Work Station Active indicators come on.

**Step 15** Do the Ready and Work Station Active indicators come on?

**YES** - Go to step 19 on page 30.

**NO** - Go to step 16.

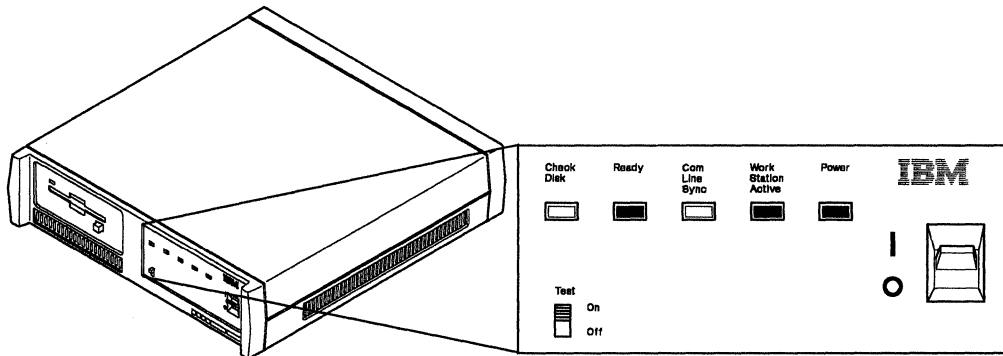

**Step 16** You may have a diskette problem. Is the Check Disk indicator either on or blinking?

**YES** - Set the control unit power switch to off (O), and remove the system diskette.

Check the serial number of the control unit. If the serial number is 55000 or above in North America, South America, Australia, and the Far East, or 77001-BE or above in Europe, the Middle East, and Africa, your system diskette must be Release 2.1 or later.

Check your system diskette to see if you have the correct release. If you do not have the correct release, see Appendix H, "Ordering Replacement System Diskettes" on page 207 for information on obtaining new system diskettes.

If your system diskette release level is correct, insert the backup system diskette in the control unit, and repeat the procedure starting at step 14. If the failure recurs, see Appendix H, "Ordering Replacement System Diskettes" on page 207 for information on obtaining new system diskettes.

**NO** - Go to step 17 on page 29.

**Step 17** You may have a problem with work station cable attachment. Refer to the Remote Work Station Setup Worksheets. Check the following at each work station:

- All cables are attached correctly.
- Cabling to the last work station is terminated correctly.
- All work station addresses are set correctly.
- The power is set to on at all work stations.

**Note:** Your work station operator's guide or setup book contains instructions for setting addresses and terminating work stations.

To determine where your problem is occurring, set the control unit power switch to off (O) and disconnect all but one work station cable from the control unit. Set the control unit power switch to on (I). Wait 4 minutes for the Ready and Work Station Active indicators to come on. If the indicators come on, the attached work station cable is good. Set the control unit power switch to off (O), disconnect the cable, and attach another work station cable. Repeat the test until the failing cable is located.

Were you able to locate a failing cable?

**YES** - Correct the cable problem and continue with step 11 on page 27.

**NO** - Go to Step 18.

**Step 18** Set the control unit power switch to off (O). Attach work station cables to all ports. Set the control unit power switch to on (I). Wait 4 minutes for the Ready and Work Station Active indicators to come on.

Did the Ready and Work Station Active indicators come on?

**YES** - Go to step 19 on page 30.

**NO** - Contact your customer service representative. If the Ready indicator is off, report SRC D13002. If the Ready indicator is on, report SRC D13003.

**Step 19** The cursor and the System Available indicator should appear on each attached display station.

**Notes:**

- a. If a 004x or 005x SRC appears on the screen, press Reset and continue with this step.
- b. The cursor and the System Available indicator may look different or be in different locations on your display screen.

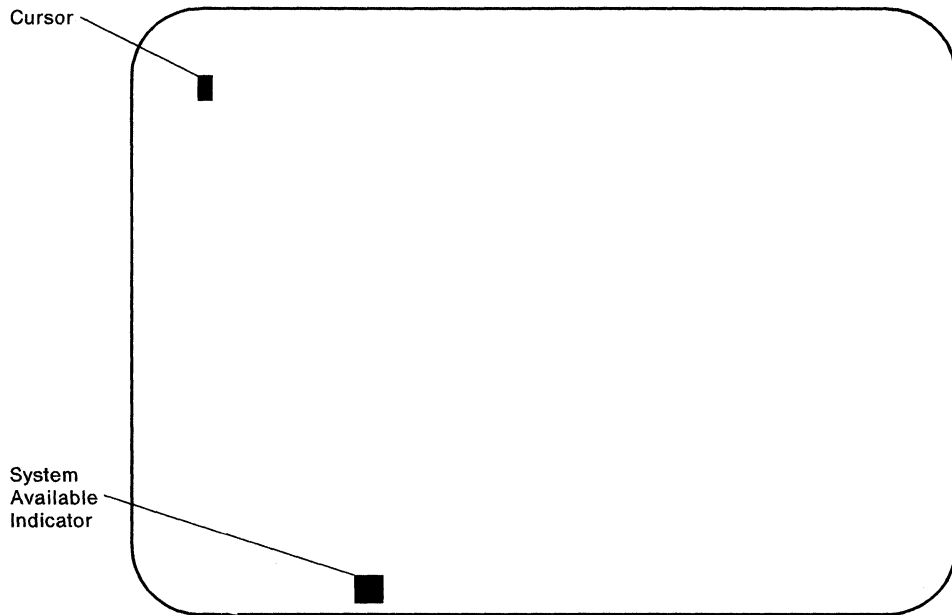

Do the cursor and the System Available indicator appear on the screen?

**YES** - Set the control unit power switch to off (O) and go to Chapter 4.

**NO** - Do the following:

- Make sure the cables are correctly connected.
- Check the terminator switch on any work station that has one. Make sure it is set correctly. Refer to the setup book that came with your work station(s) to locate terminator switches.
- If the cursor and the System Available indicator are still not present, refer to Chapter 7, "Using the Problem Determination Procedures" on page 77.

---

## Chapter 4. Configuring Your System

This chapter tells you how to configure your control unit. You can complete the following tasks using the information in this chapter:

- Display the configuration screen.
- Determine the settings for each configuration field.
- Enter and save configuration data.
- Change your system configuration.
- Solve problems that may occur during configuration.

---

### Configuring without All Work Stations Attached

The instructions in this chapter tell you how to configure the IBM 5394 with all work stations attached. If, however, you are configuring several control units at a central site or if you cannot yet attach all your work stations, you can configure the IBM 5394 with only one display station attached. In this case, all work stations that you plan to attach must use the same keyboard code (country character set).

To configure without all work stations attached, connect one display station and follow the instructions in this chapter. This display station cannot be an:

- IBM PC or Personal System/2 using AS/400 PC Support
- IBM PC AT or Personal System/2 using OS/2 Extended Edition 1.2
- IBM Personal System/55 using 5250 PC/2 AD Support.

You may use an IBM PC, Personal System/2, or Personal System/55 using a 5250 emulation program.

When you later attach and power on all work stations, the IBM 5394 will automatically recognize the presence of each work station. If any problems occur at this time, follow the instructions beginning at "Beginning Configuration" on page 32 to make sure that the control unit is recognizing all the work stations.

---

### Before You Begin Configuration

For initial configuration, you need:

- Remote Work Station Setup Worksheets.
- The Communication Worksheet. Your planner may provide you with this worksheet. If you do not have a completed worksheet, see Appendix A, "Preparing the Communication Worksheet" on page 115 for instructions.
- The nearest and most convenient attached display station. Do not use the following:
  - IBM PC or Personal System/2 using AS/400 PC Support
  - IBM PC AT or Personal System/2 using OS/2 Extended Edition 1.2
  - IBM Personal System/55 using 5250 PC/2 AD Support.

You may use an IBM PC, Personal System/2, or Personal System/55 using a 5250 emulation program.

- The Test Request key sequence for your keyboard. You use this key sequence to display the configuration screen. See Appendix F, "Key Sequences" on page 197 for the correct sequence for your keyboard.

You should also know how to use the following keys to do configuration:

- The Enter key.

The Enter key stores information on the system diskette.

- The Error Reset key.

**Note:** The Error Reset key may be labeled differently on your keyboard. In this book, these keys are referred to as the Error Reset key.

The Error Reset key resets an error on the configuration screen. Use the Error Reset key to clear system reference codes (SRCs) before making corrections.

- The Cursor Right key and Cursor Left key.

The Cursor Right key moves the cursor one field or one character to the right. The Cursor Left key moves the cursor one field or one character to the left.

- The Cursor Up key and Cursor Down key.

Use these keys to scroll the value options in each field. The Cursor Up key increases the value of the number in a field. The Cursor Down key decreases the value.

---

## Beginning Configuration

System reference codes (SRCs) may appear on the display screen during the configuration procedure. If a blinking four- or six-digit SRC appears on the screen, see Chapter 7, "Using the Problem Determination Procedures" on page 77.

**Step 1** Make sure the control unit power switch is set to off (O).

**Step 2** Set all work station power switches to on.

If you are using IBM AS/400 PC Support on any IBM Personal System/2 or IBM PC, do not start the AS/400 PC Support program until step 5 on page 33 of this procedure.

If you are using an IBM PC or IBM Personal System/2 with a 5250 emulation program (such as Enhanced 5250 Emulation or System 36/38 Work Station Emulation), set the control unit power switch to on (I) and start the emulation program now.

**Note:** Work stations that are not powered on will not appear on the configuration screen. See "Configuring without All Work Stations Attached" on page 31.

**Step 3** Make sure the Test switch on the IBM 5394 operator panel is set to On.

- Step 4** Make sure that the write-protect tab on the system diskette is closed (not write-protected). Insert the system diskette in the diskette drive.

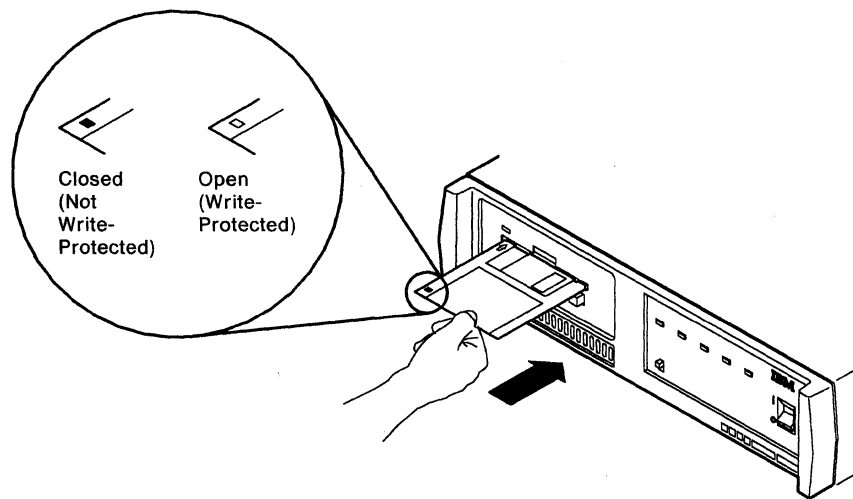

- Step 5** Make sure the control unit power switch is set to on (I).

After the IBM 5394 Ready indicator appears, start the IBM AS/400 PC Support program at each IBM Personal System/2 or IBM PC that is running AS/400 PC Support. Wait for the AS/400 PC Support router to complete initialization and become active before proceeding to the next step.

- Step 6** Go to the display you are using to configure. When the System Available indicator appears on the screen, press the Test Request key sequence to display the configuration screen. See Appendix F, "Key Sequences" on page 197 through page 204 for the correct key sequence for your keyboard.

**Note:** If you are running a 5250 emulation program, the System Available indicator appears on the host session screen, not on the PC session screen.

If an SRC appears on the display screen after you press these keys, press the Error Reset key and repeat this step.

- Step 7** Does the configuration screen appear? (The illustration in step 8 on page 34 shows a sample configuration screen. Your screen may not look exactly like this one.)

**Note:** The configuration screen appears only on the display you are using.

**YES** - Go to step 8 on page 34.

**NO** - Do the following:

- Set the control unit power switch to off (O) and repeat steps 1 through 6 on page 33.
- If the configuration screen still does not appear, see Chapter 7, "Using the Problem Determination Procedures" on page 77.



**Step 8** The following example shows the SDLC configuration screen. X.25 and X.21 communication modes use the same procedures, but have different entry fields and values. If you have a Model 02, Field 3 has slightly different default values.

**Notes:**

- a. Field 8 and Field P appear only for Release 2 or later.
- b. Your screen may display a copyright statement in English. The first valid keystroke removes this statement.

**Work Station Addresses**

**Port Numbers**

	0	1	2	3	4	5	6
0/	D	.	.	.	.	P	.
1/	D	.	.	.	.	.	.
2/	D	.	.	.	.	.	.

AA-> 0      BB-> 0  
 1-> 00      2-> 01      3-> 0 0 0 0 0 0 0 0      8-> 3C 0

P-> \_ \_

- The upper portion of the screen shows the configuration of the work stations on the three ports.

The Ds and Ps on the configuration screen show the arrangement of display stations and printers on the ports. In the preceding example, the letter D next to each of the ports shows that display stations are located at address 0 on each port. The letter P under address 5 shows that a printer is on port 0 at address 5.

**Notes:**

- If an E appears on the screen, you have too many work stations attached to the IBM 5394. See "Problem Checklist" on page 57.
  - Work stations that are not powered on will not appear on the configuration screen.
  - You can attach up to eight work stations to a Model 01B or 02B connected to an IBM System/36 or System/38. If you attach more than eight work stations, a D or P appears on the configuration screen. However, the host system will only communicate with the work stations in its configuration table.
- The lower portion of the screen contains the operator input fields.

The operator input fields differ depending on the communication mode you are using. The SDLC fields appear as the defaults. If you enter a setting other than 0 in Field AA, the fields change to display either X.25 or X.21 fields.

The default values for SDLC communication mode are shown in the following example. SDLC communication mode uses Fields AA, BB, 1, 2, 3, and, for Release 2 or later, Fields 8 and P.

**Note:** For Model 02, Field 3 has different default values than those shown.

```

AA-> 0    BB-> 0
1-> 00    2-> 01    3-> 0 0 0 0 0 0 0    8-> 3C 0
P-> _ _

```

The default values for X.25 communication mode are shown in the following example. X.25 communication mode uses Fields AA, BB, 1, 2, 4, 5, 6, 7, and P.

```

AA-> 1    BB-> 0
1-> 00    2-> 01    4-> 0 2 7    5-> 1 0 0 0 0    6-> 0 0 1 0 0 0 0
7-> 0A 03
P-> _ _

```

The default values for X.21 switched communication mode are shown in the following example. X.21 switched communication mode uses Fields AA, BB, 1, 2, A, B, C, and P.

```

AA-> 2   BB-> 0
1-> 00   2-> 01   A-> _____   B-> 05 6 0
C-> _ _ _ _ _ _ _ _ _ _ _ _ _ _ _ _
P-> _ _
  
```

**Step 9** Does a D or P appear on the screen for each attached work station that is powered on?

**YES** - Go to step 10.

**NO** - Go to "Problem Checklist" on page 57.

**Step 10** Locate the cursor on your display screen. It is under the number 0 in Field AA.

```

AA-> 0   BB-> 0
1-> 00   2-> 01   3-> 0 0 0 0 0 0 0   8-> 3C 0
P-> _ _
  
```

**Step 11** Field AA contains the setting for the communication mode. See the following table for the correct setting for your system.

Press the Cursor Up or Cursor Down key to scroll to the correct setting. Press the Cursor Right key to move to Field BB.

**Note:** If you are using an X.21 line, your communication mode can be X.21 switched or SDLC. Refer to your Communication Worksheet for the correct mode.

Communication Mode	Field AA Setting
SDLC	0
X.25	1
X.21 Switched (Model 02 only)	2

**Step 12** Field BB contains the setting for the operating mode. The operating mode is determined by the type of host system you are using. See the following table for the correct setting for your system.

Operating Mode	Field BB Setting
AS/400 (IBM 5394 Mode)	0
System/36 and System/38 (IBM 5294 Emulation Mode)	1

Scroll to the correct setting, and press the Cursor Right key to move to Field 1.

**Step 13** Field 1 contains the keyboard code. Find the keyboard code(s) on your Remote Work Station Setup Worksheets, or see the table on page 14.

- If all the display stations have the same keyboard code, scroll to that code in Field 1. Move the cursor to Field 2, and go to step 16.
- If all the display stations do not have the same keyboard code, do the following:
  - a. In Field 1, scroll to the keyboard code that is used on most display stations in your configuration.

**Notes:**

- 1) This code must be a multinational keyboard code.
  - 2) If no keyboard code represents a majority of the keyboard codes used on your display stations, use any multinational keyboard code in your configuration.
  - 3) The maximum number of multinational keyboard codes that can be selected for any configuration is four.
- b. Press Enter *twice* to store this setting. Go to step 14.

**Step 14** Refer to the Remote Work Station Setup Worksheets for the port number and work station address of any display station with a different keyboard code.

To enter the keyboard codes, do the following:

- a. Press the Cursor Right or Cursor Left key to move the cursor under the second position of Field 1.

```

AA-> 0   BB-> 0
1-> 05 - -   2-> 01   3-> 0 0 0 0 0 0 0   8-> 3C 0
P-> _ _
  
```

- b. Press the Cursor Up or Cursor Down key to scroll to the correct keyboard code for the display station.

When a valid keyboard code is in Field 1, two dashes appear beside that code.

```
AA-> 0    BB-> 0
1-> 17 - -    2-> 01    3-> 0 0 0 0 0 0 0    8-> 3C 0
P-> _ _
```

c. Press the Cursor Right key to move the cursor under the first dash next to Field 1 on the display screen.

```
AA-> 0    BB-> 0
1-> 17 _ -    2-> 01    3-> 0 0 0 0 0 0 0    8-> 3C 0
P-> _ _
```

d. Press the Cursor Up key to scroll to the port number of the display station.

```
AA-> 0    BB-> 0
1-> 17 0 -    2-> 01    3-> 0 0 0 0 0 0 0    8-> 3C 0
P-> _ _
```

e. Press the Cursor Right key to move the cursor under the second dash.

```
AA-> 0    BB-> 0
1-> 17 0 _    2-> 01    3-> 0 0 0 0 0 0 0    8-> 3C 0
P-> _ _
```

f. Press the Cursor Up key to scroll to the address of the display station.

```
AA-> 0    BB-> 0
1-> 17 0 0    2-> 01    3-> 0 0 0 0 0 0 0    8-> 3C 0
P-> _ _
```

g. Press the Enter key. The keyboard code should appear beside the correct D on the display screen.

## Work Station Addresses

**Port  
Numbers**

	0	1	2	3	4	5	6
0/	D 17	D	.	.	.	P	.
1/	D	P	D	.	.	.	.
2/	D	D	P	.	.	.	.

AA-> 0    BB-> 0  
 1-> 05 - -    2-> 01    3-> 0 0 0 0 0 0 0    8-> 3C 0

P-> \_ \_

**Step 15** Does the keyboard code appear beside the correct D on your display screen?

**YES** - Press the Enter key again to store the information on the system diskette. Repeat step 14 for any other display stations that use a different keyboard code than that you entered in step 13.

When you have entered all keyboard codes, move the cursor to Field 2, and go to step 16.

**NO** - Do the following:

- a. Press the Error Reset key and repeat step 14 of this chapter.
- b. If the keyboard code is still not correct, see Chapter 7, "Using the Problem Determination Procedures" on page 77. If an SRC appears on your display screen, see Appendix E, "System Reference Codes" on page 153.

**Step 16** Field 2 contains the control unit address (station address). This address is a two-digit hexadecimal number. You can find the control unit address on your Communication Worksheet.

Use the cursor keys to scroll to the correct setting in Field 2. Move the cursor to the next field.

**Step 17** To complete configuration for **SDLC** mode, go to "Completing Configuration for SDLC Communication" on page 40.

To complete configuration for **X.25** mode, go to "Completing Configuration for X.25 Communication" on page 44.

To complete configuration for **X.21 Switched** mode, go to "Completing Configuration for X.21 Switched Communication" on page 50.

## Completing Configuration for SDLC Communication

If you are using SDLC communication mode and you entered a 0 in Field AA, you must complete Field 3. If your IBM 5394 is Release 2 or later and you are configuring for V.25 bis auto-dial, you must also complete Field 8. If you want to configure a printer for local copy-to-printer operations (Release 2 or later), complete Field P. Each field contains several subfields.

Press the Cursor Up or Cursor Down key to scroll the options in each subfield. After you enter information, press the Cursor Right key to move to the next subfield.

Use the information from your SDLC Communication Worksheet to complete these fields.

### Field 3 (Communication Field)

Field 3 contains the settings for your modem configuration data. To complete the seven subfields of Field 3, do the following:

- Step 1** Subfield 1 selects a nonswitched, manual-dial switched, or auto-dial switched (V.25 bis) communication line. Enter the correct setting for this subfield from the following table.

Line Type	Subfield 1 Setting
Nonswitched	0
Manual-dial switched	1
Auto-dial switched (V.25 bis)	2

**Notes:**

- a. If your IBM 5394 is a Model 02, this subfield defaults to 0 and cannot be changed.
- b. For Release 1, you can select either nonswitched (0) or manual-dial switched (1).

- Step 2** Subfield 2 selects whether your modem is set to duplex or half-duplex. Enter the correct setting for this subfield from the following table.

Duplex or Half-Duplex	Subfield 2 Setting
Half-duplex	0
Duplex	1

**Note:** If your IBM 5394 is a Model 02, this subfield defaults to 1 and cannot be changed.

**Step 3** Subfield 3 selects either a multipoint or point-to-point communication line. Enter the correct setting for this subfield from the following table.

**Note:** If you use a modem that provides DTE interface fan-in/out, and you are using a point-to-point line to attach several control units to your host system, configure each control unit for multipoint communication.

Multipoint or Point-to-Point	Subfield 3 Setting
Multipoint (or fan-in/out)	0
Point-to-point	1

**Note:** If subfield 2 is set to duplex and subfield 3 is set to point-to-point, your modem must be configured to provide a constant RFS signal. The IBM 5394 sets RTS permanently on.

**Step 4** Subfield 4 selects either non-return to zero inverted (NRZI) or non-return to zero (NRZ). NRZI is recommended for an EIA/CCITT interface with analog modems or DCEs. NRZ is recommended for digital DCEs. This field must match your host configuration for NRZ/NRZI. Enter the correct setting for this subfield from the following table.

NRZI or NRZ	Subfield 4 Setting
NRZI	0
NRZ	1

**Notes:**

- a. If your IBM 5394 is a Model 02, this subfield defaults to 1 and cannot be changed.
- b. If your IBM 5394 Model 01 is attached to an X.21 network, enter a 1.

**Step 5** Subfield 5 indicates whether your modem uses pin 20 for DTR or CDSTL. Enter the correct setting for this subfield from the following table.

DTR or CDSTL	Subfield 5 Setting
DTR	0
CDSTL	1

**Notes:**

- a. If you entered a 2 in subfield 1 (V.25 bis), this subfield defaults to 0 and cannot be changed.
- b. In U.S.A. and Canada, enter a 0.
- c. If your IBM 5394 is a Model 02, this subfield defaults to 0 and cannot be changed.



- Step 6** Subfield 6 indicates whether the control unit transmits a leading pad character. The pad character is X'00'. For modems or DCEs that require a leading pad character for synchronization, leading pad transmitted should be used with NRZI mode. Enter the correct setting for this subfield from the following table.

Leading Pad	Subfield 6 Setting
Leading pad not required	0
Leading pad required	1

**Note:** If your IBM 5394 is a Model 02, this subfield defaults to 0 and cannot be changed.

- Step 7** Subfield 7 selects local loopback support. If this bit is set to on, the modem or DCE will enter local loopback mode when the Test Control 1 line is active during diagnostic testing. Enter the correct setting for this subfield from the following table.

Local Loopback	Subfield 7 Setting
Local loopback not supported	0
Local loopback supported	1

**Note:** If your IBM 5394 is a Model 02, this subfield defaults to 0 and cannot be changed.

If you are using a Release 1 system diskette, or if you are not configuring for an auto-dial switched line or a printer, go to "Saving Your SDLC Configuration Data" on page 43.

If you are configuring for an auto-dial switched line and you entered a 2 in the first subfield of Field 3, press the Cursor Right key to move to Field 8. Go to "Field 8 (V.25 bis Parameters)."

If you are configuring a printer for configuration screen printing, go to "Field P (Printer Port and Station Address)" on page 43.

## Field 8 (V.25 bis Parameters)

Field 8 (Release 2 or later) contains the settings for your V.25 bis auto-dial information. To complete the two subfields of Field 8, do the following:

- Step 1** Subfield 1 specifies the maximum number of seconds allowed to establish a call connection when using V.25 bis. This setting is a hexadecimal number between X'01' and X'FF'. The default value is 60 seconds (X'3C').

- Step 2** Subfield 2 specifies whether the V.25 bis call information will be saved on the diskette and redisplayed the next time an auto-dial call is attempted. Enter the correct setting for this subfield from the following table.

Call Information Security	Subfield 2 Setting
For security, do not save and display call information	0
Save and display call information	1

### Field P (Printer Port and Station Address)

Field P (Release 2 or later) contains the settings for the port address and station address of a printer for configuration screen printing. If you do not select a printer by completing this field, the system will send print jobs to the first available printer that is powered on. To complete the subfields of Field P, do the following:

- Step 1** Subfield 1 specifies the port address. Valid port address selections are 0, 1, or 2. Enter the correct setting for this subfield.
- Step 2** Subfield 2 specifies the station address. Valid station address selections are between 0 and 6. Enter the correct setting for this subfield.

### Saving Your SDLC Configuration Data

When you have completed entering the fields for SDLC communication, do the following:

- Step 1** Press the Enter key *twice* to store the configuration information on the system diskette.
- Step 2** Make sure that the diskette activity indicator on the front of the control unit is off.
- Step 3** Remove the system diskette.
- Step 4** Make sure that the write-protect tab on the backup system diskette is closed (not write-protected). Place the backup system diskette in the diskette drive.
- Step 5** Press the Enter key *twice* to store the information on the backup system diskette.
- Step 6** If you have Release 2 or later and you have a printer attached to your IBM 5394, you can make a copy of your configuration information for future reference. To make a copy, press the Local Copy key sequence. See Appendix F, "Key Sequences" on page 197 for the correct key sequence for your keyboard. If you selected a printer in Field P, the copy will print at the specified printer. If you did not select a printer in Field P, the copy will print at the first available printer that is powered on. Field P will display the port and station address of the printer when the print operation is complete.

**Step 7 Configuration is complete.** Make sure that the write-protect tabs on the diskettes are closed (not write-protected). Store one system diskette and all worksheets in a safe place. Keep the other system diskette in the diskette drive when operating the IBM 5394. If you move the IBM 5394 from one location to another, remove the diskette from the diskette drive.

**Step 8** Go to Chapter 5, "Connecting Your Communication Line" on page 59.

## Completing Configuration for X.25 Communication

If you are using X.25 communication mode and you entered a 1 in Field AA, you must complete Fields 4, 5, 6, and 7. If you want to configure a printer for local copy-to-printer operations (Release 2 or later), you must complete Field P. Each field contains several subfields as shown in the following example.

```

AA-> 1    BB-> 0
1-> 00    2-> 01    4-> 0 2 7    5-> 1 0 0 0 0    6-> 0 0 1 0 0 0 0
7-> 0A 03
P-> _ _
  
```

Press the Cursor Up or Cursor Down key to scroll the options in each subfield. After you enter information, press the Cursor Right key to move to the next subfield.

Use the information from your X.25 Communication Worksheet to complete these fields.

### Field 4 (X.25 Subscription Data)

To complete the three subfields of Field 4, do the following:

**Step 1** Subfield 1 selects packet level sequence numbering. Enter the correct setting for this subfield from the following table.

Packet Numbering	Subfield 1 Setting
Modulo 8	0
Modulo 128	1

**Step 2** Subfield 2 selects the packet window size. Valid settings for this field depend on the packet numbering scheme you selected in the first subfield. See the following table for the range of correct settings, and enter this setting in Subfield 2.

Packet Window Size	Subfield 2 Setting
For Modulo 8	X'2' to X'7'
For Modulo 128	X'2' to X'F'

**Step 3** Subfield 3 selects the link window size. Valid entries are X'1' to X'7'.

## Field 5 (X.25 Configuration Data)

To complete the five subfields of Field 5, do the following:

- Step 1** Subfield 1 selects the packet size. Enter the correct setting for this subfield from the following table.

Packet Size	Subfield 1 Setting
64 bytes	0
128 bytes	1
256 bytes	2
512 bytes (Release 2 or later)	3

- Step 2** Subfield 2 selects the virtual circuit type. Enter the correct setting for this subfield from the following table.

Virtual Circuit Type (PVC = permanent virtual circuit, SVC = switched virtual circuit)	Subfield 2 Setting
Multiple PVCs, multiple SVCs, or SVC call allowed	0
Single PVC	1
Single SVC answer only (Release 2 or later)	2

### Notes:

- For Release 1 system diskettes having a single SVC used for answer only, this field should be set to 0.
- For single PVC or single SVC answer only, if manual options are not allowed (subfield 4), the IBM 5394 will begin link initialization after power-on without any operator input.
- Your subscription may include multiple PVCs or multiple SVCs. However, the IBM 5394 communicates on only one assigned channel at a time. Packets arriving on a channel other than the assigned channel are discarded with no response.

- Step 3** Subfield 3 specifies whether your X.25 subscription allows flow control negotiation. Enter the correct setting for this subfield from the following table.

Flow Control Negotiation	Subfield 3 Setting
Not permitted	0
Permitted	1

- Step 4** Subfield 4 specifies whether the IBM 5394 operator is allowed to enter manual options when establishing communications. Enter the correct setting for this subfield from the following table.

Manual Options Allowed	Subfield 4 Setting
Manual options not allowed (operator allowed to enter network address, logical channel ID, and password only)	0
Manual options allowed (operator allowed to enter all applicable options)	1

**Note:** If manual options are allowed, Subfield 3 must be set to 1.

- Step 5** Subfield 5 specifies whether your modem or DCE supports local loopback initiated by interface pin 18. Enter the correct setting for this subfield from the following table.

Local Loopback	Subfield 5 Setting
Not supported	0
Supported	1

## Field 6 (X.25 Software Data)

To complete the six subfields of Field 6, do the following:

- Step 1** Subfield 1 specifies whether you subscribe to the reverse charging facility and accept incoming calls that specify reverse charging. Enter the correct setting for this subfield from the following table.

Reverse Charging	Subfield 1 Setting
Do not accept	0
Accept	1

- Step 2** Subfield 2 selects the logical link control (LLC) facility. This setting must be the same as the LLC used by your host system. Enter the correct setting for this subfield from the following table.

LLC	Subfield 2 Setting
Physical services headers (PSH)	00
Qualified LLC (QLLC)	01
Enhanced LLC (ELLC)	10

- Step 3** Subfield 3 selects special network attachment. Enter the correct setting for this subfield from the following table.

Special Network Attachment	Subfield 3 Setting
No Telenet**-type network; IBM 5394 responds with Disconnect mode (DM) to a DISC received before sending SABM.	0
Telenet-type network; IBM 5394 responds with Unnumbered Acknowledgment (UA) when polled with Disconnect (DISC) before sending Set Asynchronous Balanced mode (SABM).	1

- Step 4** Subfield 4 specifies whether the network only or the network and the control unit can initiate the link by sending a SABM. Enter the correct setting for this subfield from the following table.

Link Initiation	Subfield 4 Setting
Network or IBM 5394	0
Network only	1

- Step 5** Subfield 5 indicates which CCITT X.25 Recommendation the IBM 5394 must support. Enter the correct setting for this subfield from the following table.

Network Subscription	Subfield 5 Setting
CCITT X.25 Recommendation (1984)	0
CCITT X.25 Recommendation (1980)	1

- Step 6** Subfield 6 selects the format of diagnostic codes used by the IBM 5394. Enter the correct setting for this subfield from the following table.

Diagnostic Codes	Subfield 6 Setting
1984 Systems Network Architecture (SNA) format diagnostics codes	0
1984 International Standards Organization (ISO) format diagnostics codes	1
1980 SNA format diagnostics codes	2

**Note:** If you selected CCITT X.25 Recommendation (1980) in subfield 5, you must enter a 2 in subfield 6.

## Field 7 (Retry Parameters)

To complete the two subfields in Field 7, consider the following:

- Step 1** Subfield 1 specifies the number of attempts the IBM 5394 makes to solicit a response from the DCE to a transmitted frame (N<sup>2</sup><sup>3</sup>). This value can range from X'00' (no attempts) to X'FF' (255 attempts). The default value is X'0A' (10 attempts). Your network supplier may impose restrictions on this value to limit network congestion.

- Step 2** Subfield 2 specifies the time, in seconds, the IBM 5394 waits before timing out for a response to a transmitted frame (T<sup>1</sup><sup>3</sup>). This value can range from X'01' (1 second) to X'3C' (60 seconds). The default value is X'03' (3 seconds). Your network supplier may also restrict this value.

If you are using a Release 1 system diskette, or if you are not configuring a printer, go to "Saving Your X.25 Configuration Data" on page 49.

If you are configuring a printer for configuration screen printing, go to "Field P (Printer Port and Station Address)."

## Field P (Printer Port and Station Address)

Field P (Release 2 or later) contains the settings for the port address and station address of a printer for configuration screen printing. If you do not select a printer by completing this field, the system will send print jobs to the first available printer that is powered on. To complete the subfields of Field P, do the following:

- Step 1** Subfield 1 specifies the port address. Valid port address selections are 0, 1, or 2. Enter the correct setting for this subfield.
- Step 2** Subfield 2 specifies the station address. Valid station address selections are between 0 and 6. Enter the correct setting for this subfield.

<sup>3</sup> CCITT X.25 Recommendation parameter

## Saving Your X.25 Configuration Data

When you have completed entering the fields for X.25 communication, do the following:

- Step 1** Press the Enter key *twice* to store the configuration information on the system diskette.
- Step 2** Make sure that the diskette drive activity indicator on the front of the control unit is off.
- Step 3** Remove the system diskette.
- Step 4** Make sure that the write-protect tab on the backup system diskette is closed (not write-protected). Place the backup system diskette in the diskette drive.
- Step 5** Press the Enter key *twice* to store the information on the backup system diskette.
- Step 6** If you have Release 2 or later and you have a printer attached to your IBM 5394, you can make a copy of your configuration information for future reference. To make a copy, press the Local Copy key sequence. See Appendix F, "Key Sequences" on page 197 for the correct key sequence for your keyboard. If you selected a printer in Field P, the copy will print at the specified printer. If you did not select a printer in Field P, the copy will print at the first available printer that is powered on. Field P will display the port and station address of the printer when the print operation is complete.
- Step 7** **Configuration is complete.** Make sure that the write-protect tabs on the diskettes are closed (not write-protected). Store one system diskette and all worksheets in a safe place. Keep the other system diskette in the diskette drive when operating the IBM 5394. If you move the IBM 5394 from one location to another, remove the diskette from the diskette drive.
- Step 8** Go to Chapter 5, "Connecting Your Communication Line" on page 59.



## Completing Configuration for X.21 Switched Communication

If you are using X.21 switched communication mode and you entered a 2 in Field AA, you must complete Fields A, B, and C. If you want to configure a printer for local copy-to-printer operations (Release 2 or later), you must complete Field P. Each field contains several subfields as shown in the following example.

```
AA-> 2      BB-> 0
1-> 00      2-> 01      A-> _____      B-> 05 6 0
C-> _____
P-> _ _
```

Press the Cursor Up or Cursor Down key to scroll the options in each field. After you enter information, press the Cursor Right key to move to the next field.

Use the information from your X.21 Switched Communication Worksheet to complete these fields.

### Field A (Data Network Identification Field)

Field A contains the X.21 network ID (IBM 5394 telephone number). This number can be from 1 to 15 decimal digits.

Press the Cursor Up or Cursor Down key to enter the correct network ID in Field A.

### Field B (X.21 Short Hold Mode Retry Parameters)

Field B contains information for automatic call retry in Short Hold mode (SHM). To complete the three subfields of Field B, consider the following:

- Step 1** Subfield 1 specifies the number of retries. This value can range from X'00' (no retries) to X'FF' (255 retries). The default value is X'05' (5 retries). This value must comply with national requirement limits.
- Step 2** Subfield 2 specifies the time, in seconds, between retry attempts. This value can range from X'1' (1 second) to X'F' (15 seconds). The default value is X'6' (6 seconds). This value must comply with national requirement limits.
- Step 3** Subfield 3 selects direct call support in SHM. Enter the correct setting for this subfield from the following table.

Direct Call in SHM	Subfield 3 Setting
IBM 5394 will use host system XID dial digits to initiate SHM reconnection (address call)	0
IBM 5394 will not use dial digits (direct call)	1

## Field C (Optional Call Progress Signals)

Field C contains up to eight optional call progress signal (CPS) codes. During SHM link reestablishment, the IBM 5394 automatically retries all 2x and 6x CPSs received from the network using the parameters specified in Field B. The IBM 5394 can retry other CPSs.

The following table lists the CPSs that can be optionally retried. Since 2x and 6x codes are automatically retried, they are not included in this table.

Code	Significance
01	Terminal called
02	Redirected call
03	Connect when free
04	Private network reached
05	Public network reached
41	Access barred
42	Changed number
43	Not obtainable
44	Out of order
45	Controlled not ready
46	Uncontrolled not ready
47	DCE power off
48	Invalid facility request
49	Network fault in local loop
51	Call information service
52	Incompatible user class of service
71	Long-term network congestion
72	RPOA out of order

Enter up to eight two-digit codes in Field C.

Check your national requirements.

If you are using a Release 1 system diskette, or if you are not configuring a printer, go to "Saving Your X.21 Switched Configuration Data" on page 52.

If you are configuring a printer for configuration screen printing, go to "Field P (Printer Port and Station Address)."

## Field P (Printer Port and Station Address)

Field P (Release 2 or later) contains the settings for the port address and station address of a printer for configuration screen printing. If you do not select a printer by completing this field, the system will send print jobs to the first available printer that is powered on. To complete the subfields of Field P, do the following:

- Step 1** Subfield 1 specifies the port address. Valid port address selections are 0, 1, or 2. Enter the correct setting for this subfield.
- Step 2** Subfield 2 specifies the station address. Valid station address selections are between 0 and 6. Enter the correct setting for this subfield.

## Saving Your X.21 Switched Configuration Data

When you have completed all fields for X.21 switched communication, do the following:

- Step 1** Press the Enter key *twice* to store the configuration information on the system diskette.
- Step 2** Make sure that the diskette activity indicator on the front of the control unit is off.
- Step 3** Remove the system diskette.
- Step 4** Make sure that the write-protect tab on the backup system diskette is closed (not write-protected). Place the backup system diskette in the diskette drive.
- Step 5** Press the Enter key *twice* to store the information on the backup system diskette.
- Step 6** If you have Release 2 or later and you have a printer attached to your IBM 5394, you can make a copy of your configuration information for future reference. To make a copy, press the Local Copy key sequence. See Appendix F, "Key Sequences" on page 197 for the correct key sequence for your keyboard. If you selected a printer in Field P, the copy will print at the specified printer. If you did not select a printer in Field P, the copy will print at the first available printer that is powered on. Field P will display the port and station address of the printer when the print operation is complete.
- Step 7** **Configuration is complete.** Make sure that the write-protect tabs on the diskettes are closed (not write-protected). Store one system diskette and all worksheets in a safe place. Keep the other system diskette in the diskette drive when operating the IBM 5394. If you move the IBM 5394 from one location to another, remove the diskette from the diskette drive.
- Step 8** Go to Chapter 5, "Connecting Your Communication Line" on page 59.

---

## Configuring Additional Work Stations

If you later add another display station or printer, you do not need to reconfigure the IBM 5394 unless:

- The new work station uses a different keyboard code. The IBM 5394 will use the keyboard code currently defined for the port and station address or the one defined in Field 1.
- You encounter a problem making the new work station operational.

If you need to reconfigure, complete revised copies of the Remote Work Station Setup Worksheet. You need the following information from this worksheet:

- The work station address for the new display station or printer
- Cabling instructions
- Keyboard code for new display station (if needed).

For this procedure, use any convenient display station except the following:

- IBM PC or Personal System/2 using AS/400 PC Support
- IBM PC AT or Personal System/2 using OS/2 Extended Edition 1.2
- IBM Personal System/55 using 5250 PC/2 AD Support.

You may use an IBM PC, Personal System/2, or Personal System/55 using a 5250 emulation program.

**Step 1** Make sure that the new work station is set up and that all work stations are cabled according to the *revised* Remote Work Station Setup Worksheet.

**Step 2** Make sure that the work station address for the display station or printer you are adding is set correctly. Refer to the work station setup book for information on setting the work station address.

**Step 3** Make sure that your host system has a device configuration for the new work station.

**Step 4** The IBM 5394 will recognize that your new work station is present when it is powered on. You do not need to reconfigure your IBM 5394 unless:

- The new work station uses a different keyboard code. The IBM 5394 will use the keyboard code currently defined for the port and station address or the one defined in Field 1.
- You encounter a problem making the new work station operational.

Do you want to reconfigure your IBM 5394?

**YES** - Go to step 5.

**NO** - The task is complete.

**Step 5** Follow the instructions in steps 1 through 8 beginning on page 32 to display the configuration screen.

**Step 6** Look for a D or P on the screen for each work station attached to the IBM 5394.

If an E appears on the screen, you have too many work stations attached to the IBM 5394. See "Problem Checklist" on page 57.

**Note:** You can attach up to eight work stations to a Model 01B or 02B connected to an IBM System/36 or System/38. If you attach more than eight work stations, a D or P appears on the configuration screen. However, the host system will communicate only with the work stations in its configuration table.

Does a D or P appear in the correct position for each work station you attached?

**YES** - Go to step 8 on page 54 if you attached a printer. Go to step 7 on page 54 if you attached a display station.

**NO**- See "Problem Checklist" on page 57.

- Step 7** Refer to the *revised* Remote Work Station Setup Worksheet. Is the keyboard code for the display station you just attached different from the other display stations?
- YES** - Go to step 14 on page 37.
- NO** - Go to step 8.
- Step 8** Press the Enter key *twice* to store the configuration information on the system diskette. Remove the system diskette, insert the backup system diskette in the diskette drive, and press the Enter key twice.
- Step 9** If you have Release 2 or later and you have a printer attached to your IBM 5394, you can make a copy of your new configuration information for future reference. To make a copy, press the Local Copy key sequence. See Appendix F, "Key Sequences" on page 197 for the correct key sequence for your keyboard. If you selected a printer in Field P, the copy will print at the specified printer. If you did not select a printer in Field P, the copy will print at the first available printer that is powered on. Field P will display the port and station address of the printer when the print operation is complete.
- Step 10** Make sure that the write-protect tabs on the diskettes are closed (not write-protected). Store the backup diskette and all worksheets in a safe place. Keep the other system diskette in the diskette drive when operating the IBM 5394. If you move the IBM 5394 from one location to another, remove the diskette from the diskette drive.

---

## Copying Configuration Information to New System Diskettes

If you obtain new system diskettes, you can copy your configuration data to the new diskettes without reentering the information.

To copy information from your existing system diskette to a new system diskette, do the following:

- Step 1** Make sure the control unit power switch is set to off (O).
- Step 2** Go to the display station you are using for this procedure. Set the power switch to on (I).
- Step 3** Make sure that your new system diskette is in the control unit diskette drive and that the write-protect tab on the diskette is closed (not write-protected).
- Step 4** Set the control unit Test switch to On.
- Step 5** Set the control unit power switch to on (I).
- Step 6** When the System Available indicator appears on your display station screen, press the Test Request key sequence to display the configuration screen. See Appendix F, "Key Sequences" on page 197 for the correct key sequence for your keyboard.

If the configuration screen does not appear, repeat steps 1 through 6. If the configuration screen still does not appear, see Chapter 7, "Using the Problem Determination Procedures" on page 77.

**Note:** Work stations that are not on will not appear on the configuration screen. All configuration information will be copied to the new system diskette even though these work stations do not appear on the screen.

- Step 7** Remove the new diskette from the diskette drive.
- Step 8** Make sure that the write-protect tab on the existing system diskette is closed (not write-protected). Insert the existing diskette in the diskette drive.
- Step 9** Press the Read Configuration key sequence to read the previous configuration data. See Appendix F, "Key Sequences" on page 197 for the correct key sequence for your keyboard.
- Step 10** Remove the existing diskette from the diskette drive.
- Step 11** Insert the new system diskette in the diskette drive.
- Step 12** Press the Enter key *twice* to store the configuration information on the new system diskette.

- Step 13** When the diskette activity indicator goes off, remove the system diskette.
- Step 14** If you have a new backup system diskette, repeat steps 8 and 12 to store the information on this diskette.
- Step 15** Make sure that the write-protect tab on each system diskette is closed (not write-protected). Store one new system diskette in a safe place. Keep the other system diskette in the diskette drive when operating the IBM 5394.

---

## Problem Checklist

The following table explains the configuration screen layout symbols.

D	=	Display station
P	=	Printer
E	=	Extra work station
•	=	No work station at this address

If the Ds and Ps on your display screen do not match the information on your worksheets, make the following checks:

- Step 1** Make sure all the attached display stations and printers are set up and that the power is on.
- Step 2** Make sure all the cables connected to the ports on the control unit are connected properly and securely fastened. Also make sure the cables are securely fastened to the work stations.
- Step 3** Make sure the work station address of each work station is set correctly. If you are unsure of any work station address, refer to your Remote Work Station Setup Worksheet.
- Step 4** Check the terminator switch on any work station that has one. Make sure it is set correctly. Refer to the setup book that came with your work station(s) to locate terminator switches.
- Step 5** A period (.) on your configuration screen display indicates no work station at that address. If a period appears where a D or P should appear, check items 1 through 4. If a period still appears, see Chapter 7, "Using the Problem Determination Procedures" on page 77.
- Step 6** An E on your configuration screen indicates too many work stations are attached to the IBM 5394. An E appears if:
- You attach more than four work stations to a Model 01A or 02A.
  - You attach more than eight work stations to a Model 01B or 02B connected to an IBM System/36 or System/38.
  - You attach more than 16 work stations to a Model 01B or 02B connected to an IBM AS/400 system.
- If you are not sure which work stations to disconnect, contact your planner.
- Step 7** After you have checked all of the above, repeat Chapter 4.





## Chapter 5. Connecting Your Communication Line

This chapter describes how to connect the communication cable between the IBM 5394 and your modem or data circuit-terminating equipment (DCE).

**CAUTION:**

Turn power off and unplug the power cord from the receptacle before connecting or disconnecting signal cables.

**Step 1** Set the control unit power switch to off (O).

**Step 2** Set the Test switch to Off.

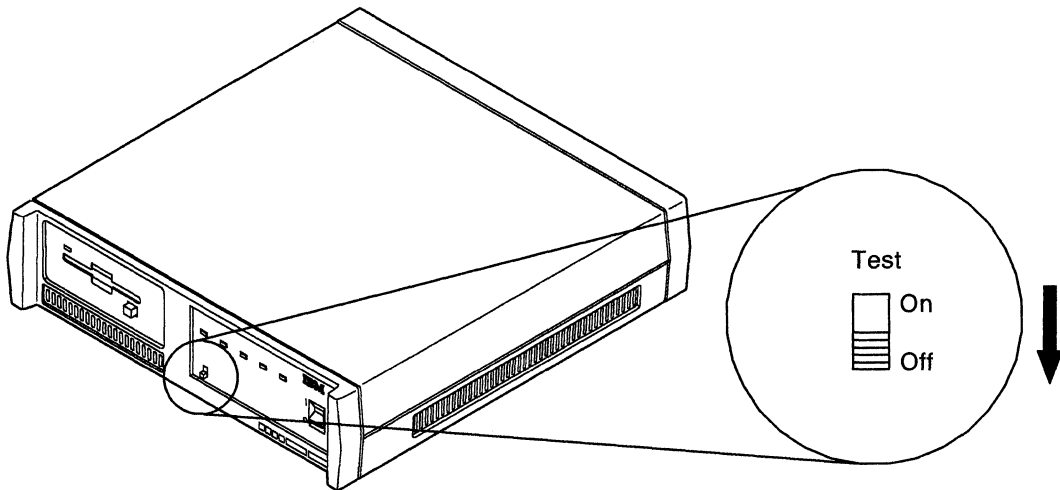

**Step 3** Disconnect the control unit power cord from the electrical outlet.

**Step 4** Connect the communication cable to the IBM 5394 and turn the thumbscrews clockwise until tight.

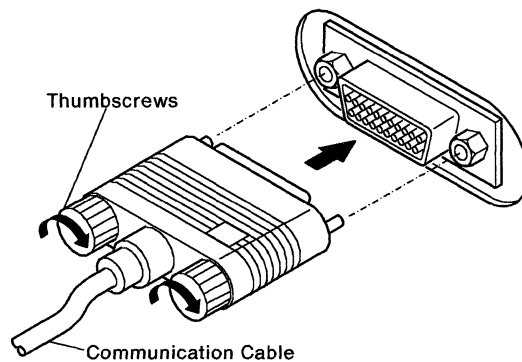

- Step 5** Connect the control unit to your modem or DCE by doing the following:
- Make sure you have the communication cable that comes with the IBM 5394.
  - Connect the communication cable to the receptacle on the modem or DCE.
  - Turn the thumbscrews clockwise until tight.

**Note:** Your cable connector may look different from the example.

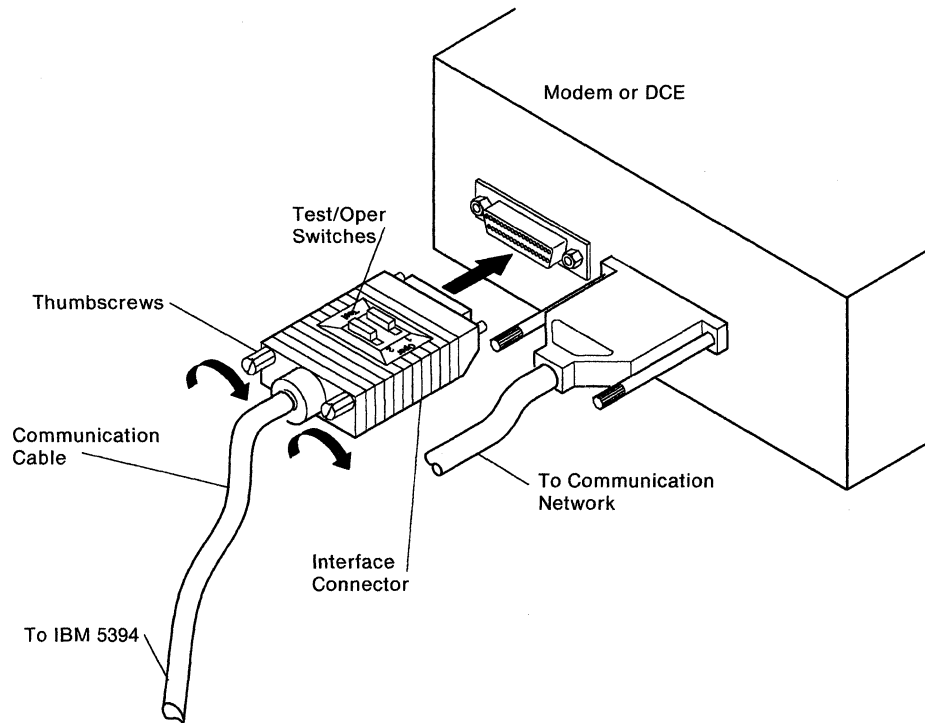

- Step 6** Make sure the Test/Oper switch (or switches) on the communication cable from the control unit is in the OPER position.

**Note:** Your connector may have one to three Test/Oper switches. All switches must be set to the OPER position.

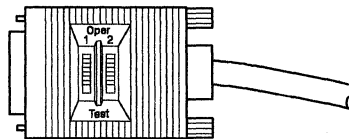

**CAUTION:**

**For your safety, you must connect equipment only to a properly wired and grounded outlet. An improperly wired outlet can place hazardous voltage on accessible metal parts of the equipment. The customer is responsible for outlet wiring.**

- Step 7** Connect the modem or DCE power cable to a correctly grounded power source and set the power switch to on. Make sure the modem or DCE is connected to the network.
- Step 8** Connect the control unit power cord to a grounded electrical outlet.
- Step 9** Set the control unit power switch to on (I).
- Step 10** All the control unit indicators come on for about 1 second. Then all indicators except the Power indicator go off. Within 2 minutes, the Ready and Work Station Active indicators come on.

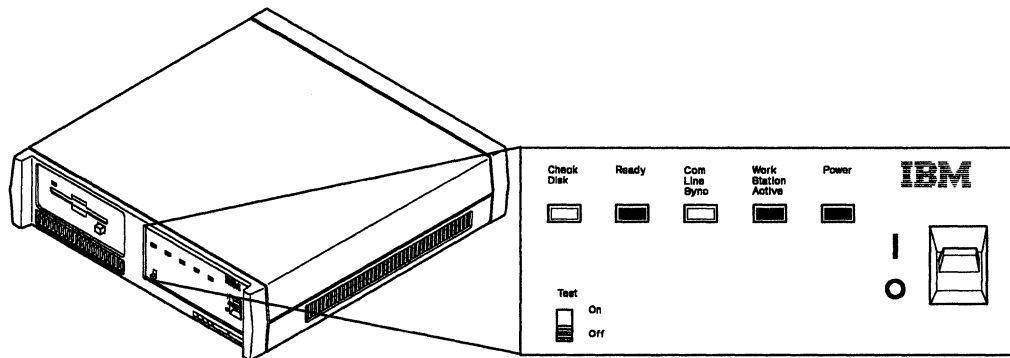

Do the indicators come on?

**YES - IBM 5394 setup is complete.** Go to Chapter 6, "Communicating with Your Host System" on page 63.

**NO - Do the following:**

- Make sure all the cable connectors are secure.
- If the indicators are still not on, refer to Chapter 7, "Using the Problem Determination Procedures" on page 77.
- If a D91010 system reference code (SRC) appears on the screen, contact your customer service representative. Report the SRC and that the IBM 5394 is not operating correctly.



---

## Chapter 6. Communicating with Your Host System

This chapter tells you how to establish and end communication with the host system. You can complete the following tasks using the information in this chapter:

- Establish communication with the host system in SDLC, X.25, or X.21 switched communication mode.
- Change subscription parameters for X.21 switched communication mode.
- End communication in X.25, X.21 switched, or SDLC (using V.25 bis) communication mode.

---

## Before You Establish Communication

Before you can establish communication with the host, you need to have line descriptions, control unit descriptions, and device descriptions configured at the host system. The control unit and devices must also be brought online.

The IBM 5394 supports three communication modes. They are:

- SDLC
- X.25
- X.21 switched.

The control unit uses these communication modes to transfer data over communication lines. Each communication mode has a different set of procedures to establish communication with the host system.

Some of the procedures in this chapter require you to enter data from a display station keyboard. To do these procedures, you need a completed Applications Worksheet. You should have this worksheet if you are using:

- V.25 bis auto-dial in SDLC communication mode
- X.25 communication mode
- X.21 switched communication mode.

See Appendix B, "Preparing the Applications Worksheet" on page 127 for instructions.

Other procedures do not require that you enter data from a display station keyboard. The logon screen appears on the display station shortly after the control unit power switch is set to on (I) and the control unit reaches the ready state.

If an error occurs during the communication procedure, a system reference code (SRC) may appear on the display screen. This code can be 4 or 6 alphanumeric characters and identifies a failure or status condition. If an SRC appears on the screen, go to Chapter 7, "Using the Problem Determination Procedures" on page 77.

Your control unit and attached work stations must be set up and configured before you begin this procedure.

---

## Establishing Communication with the Host System

To establish communication with the host system, do the following:

- Step 1** Make sure that the display stations and printers are on.
- Step 2** Make sure that the control unit power switch is set to off (O) and that the system diskette is in the diskette drive.
- Step 3** Make sure the control unit Test switch is set to Off.
- Step 4** Make sure that the host system operator has brought the control unit online.
- Step 5** Set the control unit power switch to on (I). The Ready indicator should come on within 2 minutes.
- Step 6** Go to the appropriate section for establishing communication for your communication mode:
  - “Establishing Communication in SDLC Mode”
  - “Establishing Communication in X.25 Mode” on page 70
  - “Establishing Communication in X.21 Switched Mode” on page 71.

If you do not know your communication mode, see Appendix D, “Determining Your Communication Mode” on page 151.

### Establishing Communication in SDLC Mode

- Step 1** Is this a nonswitched or switched communication line?
  - If the communication line is nonswitched, no special action is required to establish communication with the host system. Go to step 2.
  - If the communication line is switched, go to step 3 on page 66.

**Note:** If you do not know if your line is switched or nonswitched, go to Appendix D, “Determining Your Communication Mode” on page 151.

- Step 2** Does the logon screen appear within 2 minutes?

**YES - The communication procedure is complete.**

**NO -** If an SRC is displayed (blinking) on the screen, go to Appendix E, “System Reference Codes” on page 153.

If an SRC is not displayed, go back to step 1 under Establishing Communication with the Host System and repeat the procedure.

If the logon screen still does not appear, go to Chapter 7, “Using the Problem Determination Procedures” on page 77.



- Step 3** See the following table to determine the correct procedures for establishing communication with the host system.

<b>If you are:</b>	<b>Go to:</b>
Manually dialing the host system	"Manual-Dial Procedures"
Automatically dialing the host system (V.25 bis)	"Auto-Dial Procedures" on page 67
Manually answering a call from the host system	"Manual-Answer Procedures" on page 69
Automatically answering a call from the host system	"Auto-Answer Procedures" on page 69

### Manual-Dial Procedures

To dial the host site number manually, do the following:

- Step 1** Set the Mode switch on the modem to the Talk position.
- Step 2** Lift the handset from the telephone and pull up the exclusion key (a key on the telephone located under the handset that is used to establish communication).

- Step 3** Dial the host site number.

- Step 4** When the host site is ready, you hear the answer tone.

**Note:** When the IBM 3872 is used, the location receiving the call must go to the Data position (by hanging up the handset) first.

- Step 5** Wait until the answer tone ends.

- Step 6** Set the Mode switch on the modem to the Data position.

- Step 7** Hang up the handset.

- Step 8** **The procedure is complete.** A logon screen appears.

If a logon screen does not appear, call the host system operator and make sure that the IBM 5394 is online. If the logon screen still does not appear, go to Chapter 7, "Using the Problem Determination Procedures" on page 77.



**Step 2** Follow the instructions on the Applications Worksheet.

Your IBM 5394 may be configured to save call information. In this case, a number is displayed on the screen when you press the System Request key sequence. This number may be changed before pressing Enter. Press Enter to dial the number.

**Note:** If an SRC of 500004, 500005, or 500006 appears on the screen when you attempt to create or change a telephone number, do one of the following:

- To clear the error and end the call attempt, press the Reset key.
- To place the call without saving the telephone number:
  - a. Press the System Request key sequence.
  - b. Press the Enter key.
- To place the call and attempt to save the new number:
  - a. Set the control unit power switch to off (O).
  - b. Remove the diskette from the diskette drive. Make sure that your system diskette is Release 2 or later and that the write-protect tab on the diskette is closed (not write-protected). Reinsert the diskette, or insert your backup system diskette.
  - c. Make sure that the control unit Test switch is set to Off.
  - d. Set the power switch to on (I).
  - e. When the Ready indicator comes on, press the System Request key sequence at an attached display station.
  - f. Enter the new telephone number and press the Enter key. If the error recurs, place the call without saving the number, and contact your IBM Sales Representative for a replacement system diskette.

**Step 3** Does the logon screen appear within 2 minutes?

**YES - The procedure is complete.**

**NO** - If an SRC is displayed (blinking) on the screen, go to Appendix E, "System Reference Codes" on page 153.

If an SRC is not displayed, call the host system operator and have the control unit brought online. Go back to step 1 on page 67 and repeat the procedure.

If the logon screen still does not appear, go to Chapter 7, "Using the Problem Determination Procedures" on page 77.

## Manual-Answer Procedures

To answer a call from the host system, do the following:

- Step 1** Set the Mode switch on the modem to the Talk position.
- Step 2** Wait for the call.
- Step 3** Answer the telephone when it rings.
- Step 4** Lift the handset from the telephone and pull up the exclusion key (a key on the telephone located under the handset that is used to establish communication).
- Step 5** When you and the host site are ready, set the Mode switch on the modem to the Data position and hang up the handset.

**Note:** When the IBM 3872 is used, the location receiving the call must go to the Data position (by hanging up the handset) first.

- Step 6** **The procedure is complete.** A logon screen appears. If a logon screen does not appear, go to Chapter 7, "Using the Problem Determination Procedures" on page 77.

## Auto-Answer Procedures

To answer a call from the host system automatically, set the Mode switch on the modem to the Data position.

The IBM 5394 is now ready to answer an incoming call automatically.

**The procedure is complete.**

A logon screen appears when the host system program calls and establishes communication. If a logon screen does not appear, go to Chapter 7, "Using the Problem Determination Procedures" on page 77.



**Step 2** See the following table for the correct procedures for establishing communication with the host system.

To Open a PVC:	To Place an SVC Call:	To Answer an SVC Call:
<p>If your system is configured for single PVC and no manual options, no action is required. Otherwise, complete steps 1 through 3 on the Applications Worksheet.</p> <p>Go to step 3.</p>	<p>Complete steps 1 through 3 on the Applications Worksheet.</p> <p>Go to step 3.</p>	<p>If your system is configured for single SVC answer only and no manual options, no action is required. Otherwise, complete steps 1 through 3 on the Applications Worksheet.</p> <p>Go to step 3.</p>

**Step 3** Follow the instructions on the Applications Worksheet.

Does the logon screen appear within 2 minutes?

**YES - The communication procedure is complete.**

**NO -** If an SRC is displayed (blinking) on the screen, go to Appendix E, "System Reference Codes" on page 153.

If an SRC is not displayed, call the host system operator and have the control unit brought online. Go back to step 1 on page 65 and repeat the procedure.

If the logon screen still does not appear, go to Chapter 7, "Using the Problem Determination Procedures" on page 77.

## Establishing Communication in X.21 Switched Mode

**Step 1** Do you have a completed Applications Worksheet with instructions for establishing communication with the host system? (See the following illustration.)

**YES -** Go to step 2 on page 72.

**NO -** See Appendix B, "Preparing the Applications Worksheet" on page 127 for instructions for completing this worksheet. Do not attempt to establish communication with the host system without this worksheet. When you have a completed Applications Worksheet, go to step 2 on page 72.



**Step 3** Does the logon screen appear within 2 minutes?

**YES - The communication procedure is complete.**

**NO - Go to Chapter 7, "Using the Problem Determination Procedures" on page 77.**

---

## Changing Subscription Parameters

This procedure is valid only for **X.21 switched** communication.

Your network planner may provide you with instructions for changing subscription parameters. Complete this procedure *before* establishing communication with the host system.

To change these parameters:

**Step 1** Prepare an Applications Worksheet for the new subscription information. See Appendix B, "Preparing the Applications Worksheet" on page 127 for instructions. Line **D** of this worksheet contains the subscription information for the parameter(s) to be changed. Your planner should provide this information.

**Step 2** Make sure that the display stations and printers are on. Make sure that the control unit power switch is set to off (O).

**Step 3** Set the control unit Test switch to Off.

**Step 4** Set the power switch to on (I) and wait for the Ready and Work Station Active indicators to come on.

If these indicators do not come on within 2 minutes, go to Chapter 7, "Using the Problem Determination Procedures" on page 77.

**Step 5** Follow the instructions on the Applications Worksheet to enter the new subscription information.

**Step 6** To establish communication with the host system, go to step 1 on page 71.



---

## Ending Communication

This section provides step-by-step instructions for ending communication with the host system using the DETACH command. This command is valid only for X.25, X.21 switched, and SDLC (using V.25 bis) communication modes.

The DETACH command disconnects the data link between the IBM 5394 and the host system when no active sessions are established between them. If the data link has not been disconnected by the host system or network or as the result of an error, you must enter a DETACH command before you can establish another data link.

You can use the DETACH command in X.25 communication mode to end an ANSWER command that has been presented to the network, but remains unanswered.

For X.21 switched and SDLC (using V.25 bis) communication mode, the DETACH command is used to recover from an error (even though no SRC may appear). Use the DETACH command if you attempted to establish communication and the logon screen did not appear within 2 minutes.

**Note:** The DETACH command is *not* used to log off from the host system.

**Step 1** Press the System Request key sequence. See Appendix F, "Key Sequences" on page 197 for the correct sequence for your keyboard.

**Step 2** To enter a DETACH command, type a D and press the Enter key.  
The IBM 5394 disconnects from the network.

**The procedure is complete.**

---

## Repackaging, Moving, and Storing the IBM 5394

Follow the instructions in this section carefully if you need to store or move the IBM 5394 to a new location.

### Repackaging and Moving

To pack and move your IBM 5394, do the following:

1. Make sure that all cables are labeled correctly. Disconnect the cables.
2. Place the IBM 5394 system diskette and backup diskette in a protective covering. Use a plastic sleeve or an envelope.

**Warning:** Remove the diskette from the diskette drive before you move the IBM 5394.

3. Pack the IBM 5394 in its original shipping container.
  - a. Open the shipping container and remove the top piece of foam packing and the plastic bag.
  - b. Slip the IBM 5394 into the plastic bag with the front of the machine facing the bottom of the bag.
  - c. Insert the IBM 5394 into the shipping container and adjust the machine to fit properly into the bottom piece of foam packing.
  - d. Place the top piece of foam packing on top of the IBM 5394 in the shipping container and adjust for proper fit.
  - e. Close and tape the container securely.

### Storing

If you need to put your IBM 5394 in storage, repackage the machine in its original shipping container. Insert the IBM 5394 in the plastic bag and repack the box. Refer to the instructions in "Repackaging and Moving."



## Chapter 7. Using the Problem Determination Procedures

This chapter contains information you need to diagnose problems and recover from errors. Topics include:

- Problem determination procedures
- Problem determination flowchart.

When an error is detected, a system reference code (SRC) may appear on your display screen. This SRC can be 4 or 6 alphanumeric characters. These characters blink and are located either in the upper left corner or the lower left corner of the display screen.



Legend:

- A** - System Reference Code
- B** - System Available Indicator

**Note:** The System Available indicator on your display station may be located in a different position. Refer to your display station operator's guide for the exact location of this indicator.

## Problem Determination Procedures

These step-by-step procedures allow you to isolate and solve problems that may occur while operating the IBM 5394. Use the diagram in "Problem Determination Flowchart" on page 91 as a quick reference for these procedures.

### Step 1 Is an SRC displayed on your display screen?

**YES** - Go to Appendix E, "System Reference Codes" on page 153.

**NO** - Go to step 2.

**Warning:** Some errors may cause the diskette activity indicator to stay on for up to 5 minutes. Do not remove the diskette from the diskette drive while this indicator is on.

### Step 2 Check the following:

- The write-protect tab on the IBM 5394 system diskette is closed (not write-protected).

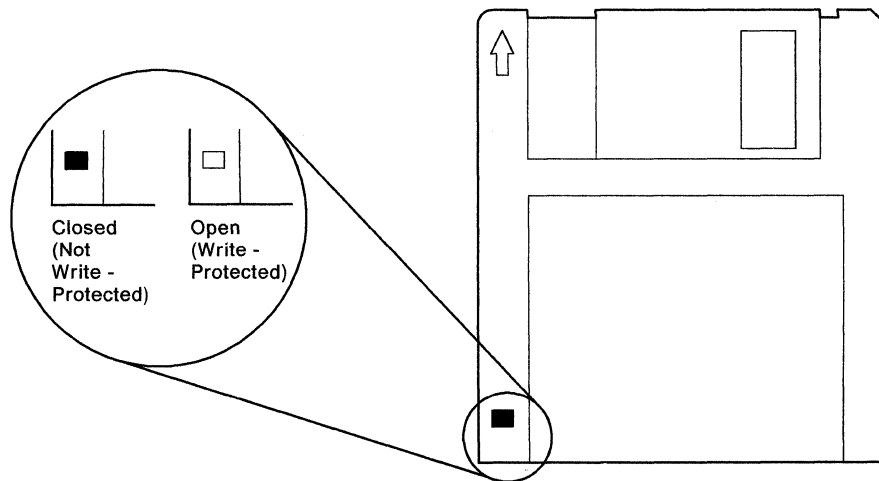

- The system diskette is in the diskette drive.
- The control unit Test switch is set to Off.

Were any problems found?

**YES** - Correct the problem. Set the control unit power switch to off (O) and back to on (I). Establish normal operation. If failure recurs, go back to step 1.

**NO** - Go to step 3 on page 79.

**Step 3** Is the IBM 5394 Power indicator on?

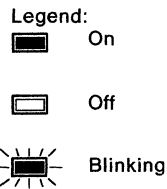
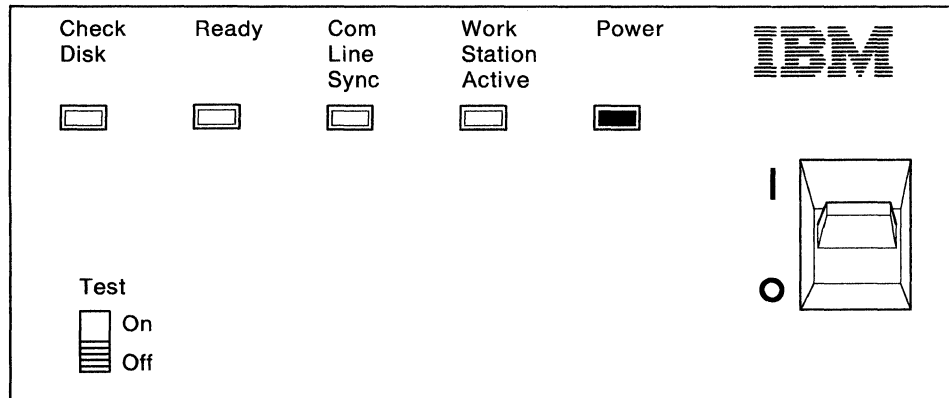

**YES** - Go to step 8 on page 81.

**NO** - Go to step 4.

**Step 4** Is the control unit power switch in the on (I) position?

**YES** - Go to step 5 on page 80.

**NO** - Set the control unit power switch to on (I) and establish normal operation. If unsuccessful, go back to step 3.

**Step 5** Is the control unit AC power indicator on?

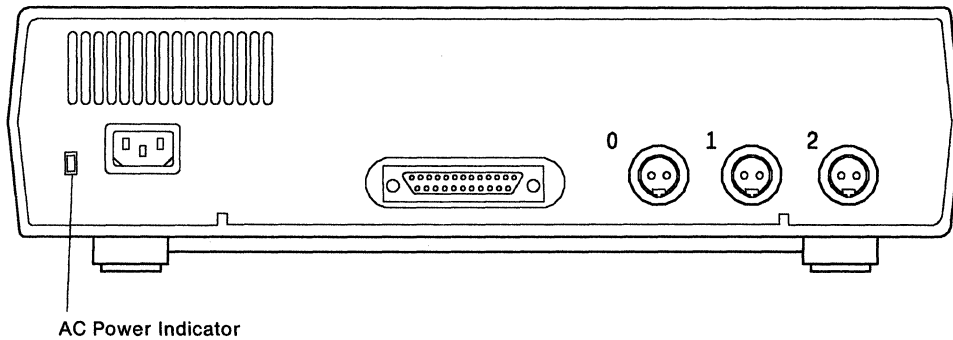

**YES** - Contact your customer service representative and report SRC D10002.

**End of procedure.**

**NO** - Go to step 6.

**Step 6** Is the power cord connected correctly to the control unit and the power outlet?

**DANGER**

**Never work on equipment, or connect or disconnect signal cables during periods of lightning activity.**

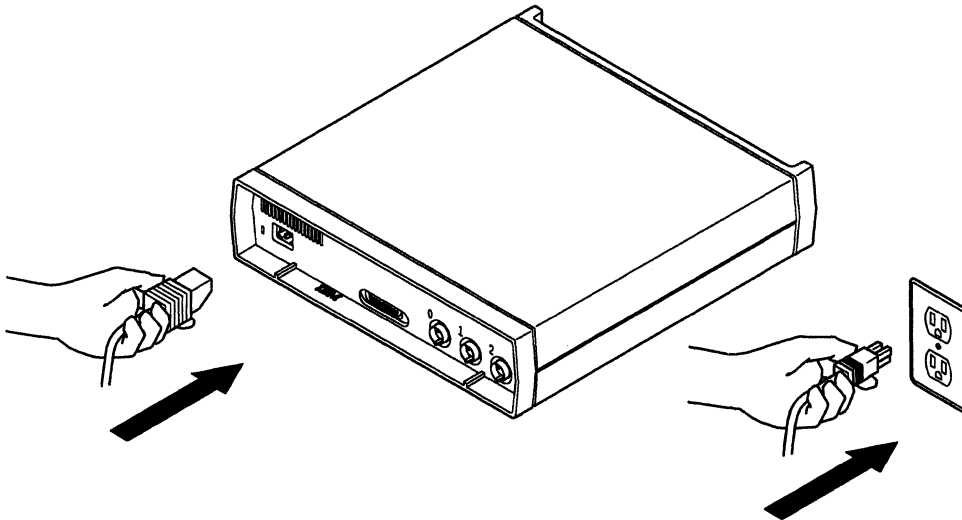

**YES** - Go to step 7.

**NO** - Set the control unit power switch to off (O).

Connect the power cord, set the control unit power switch to on (I), and establish normal operation.

If unsuccessful, go back to step 3 on page 79.

**Step 7** Is there voltage at the power outlet?

**Note:** You can determine this by plugging the power cord of some other device, such as a lamp or typewriter, into this outlet.

**YES** - Contact your customer service representative and report SRC D10001.

**End of procedure.**

**NO** - Contact your maintenance personnel to correct this condition.

**End of procedure.**

**Step 8** Is the Ready indicator blinking?

**YES** - Contact your customer service representative and report SRC D13004.

**End of procedure.**

**NO** - Go to step 9.

**Step 9** Is the Check Disk indicator either on or blinking?

**YES** - Set the control unit power switch to off (O), and remove the system diskette. If the serial number for your hardware is 55000 or above in North America, South America, Australia, and the Far East, or 77001-BE or above in Europe, the Middle East, and Africa, your system diskette must be Release 2.1 or later.

Check your system diskette to see if you have the correct release. If you do not have the correct release, see Appendix H, "Ordering Replacement System Diskettes" on page 207 for information on obtaining new system diskettes.

If the release is correct, insert the backup system diskette, and set the power switch back to on (I). If the failure recurs, call your customer service representative and report SRC D13005. If necessary, see Appendix H, "Ordering Replacement System Diskettes" on page 207 for information on obtaining new system diskettes.

**NO** - Go to step 10 on page 82.



**Step 10** Is the Ready indicator on?

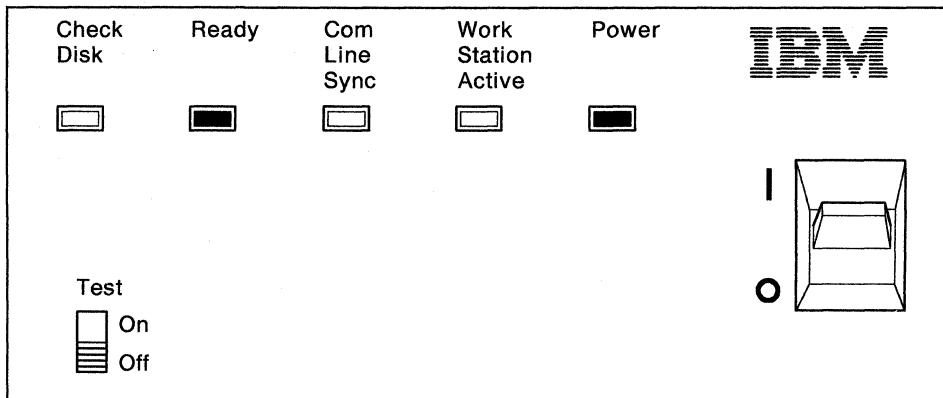

**YES** - Go to step 12.

**NO** - Go to step 11.

**Step 11** Is the Work Station Active indicator on?

**YES** - Contact your customer service representative and report SRC D13003.

**End of procedure.**

**NO** - Contact your customer service representative and report SRC D11001.

**End of procedure.**

**Step 12** Is the Work Station Active indicator on?

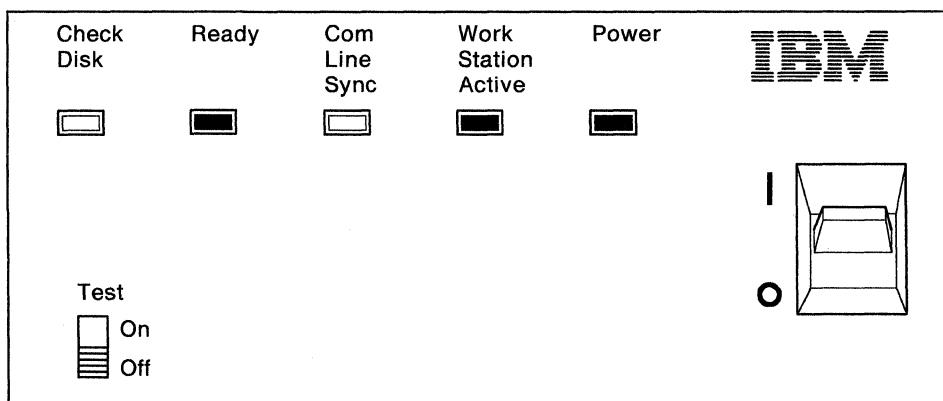

**YES** - Go to step 15 on page 83.

**NO** - Go to step 13 on page 83.

**Step 13** Refer to the Remote Work Station Setup Worksheets for your control unit to check work station installation.

Your work station operator's guide or setup book contains instructions for setting addresses and terminating work stations.

Check the following at each work station:

- All cables are attached correctly.
- Cabling to the last work station is terminated correctly.
- All work station addresses are set correctly.
- The power is set to on at all work stations.

Were any problems found?

**YES** - Correct the problem and set the work station power switch(es) to off and then to on. Set the control unit power switch to off (O) and then to on (I). Go to step 14.

**NO** - Contact your customer service representative and report SRC D13002.

**End of procedure.**

**Step 14** Is the System Available indicator on continuously at the work station? (See illustration on page 77.)

**YES** - Establish normal operation.

**End of procedure.**

**NO** - Contact your customer service representative and report SRC D13002.

**End of procedure.**

**Step 15** Is the System Available indicator on continuously at the failing work station? (See illustration on page 77.)

**YES** - Go to step 26 on page 88.

**NO** - Go to step 16.

**Step 16** Is the System Available indicator on intermittently at the failing work station?

**Note:** Observe your failing work station for 30 seconds before answering the above question.

**YES** - Go to step 17 on page 84.

**NO** - Go to step 20 on page 85.

**Step 17** Refer to the Remote Work Station Setup Worksheets for your control unit. Check all work station addresses on the port with the failing work station attached.

Your work station operator's guide or setup book contains instructions for setting and checking addresses.

Are any addresses duplicated on this port?

**YES** - Correct the error and go back to step 15 on page 83.

**NO** - Go to step 18.

**Step 18** See "Supported Work Stations" on page 3 for a list of work stations that can be attached to the IBM 5394. Is the model number of the failing work station included in this list?

**YES** - Go to step 19.

**NO** - Contact your network planner.

**End of procedure.**

**Step 19** Examine each work station connected to the port with the failing work station. Only the *last* work station attached to the port should be terminated. (Your work station operator's guide or setup book contains instructions for terminating the work station.)

Is the last work station terminated?

**YES** - Go to step 25 on page 87.

**NO** - Terminate only the last work station. Establish normal operation. If failure recurs, contact your customer service representative.

**End of procedure.**

**Step 20** Set the power switch on any failing display station or printer to off; wait 5 seconds, and then set the power switch to on.

Wait 10 seconds, and then observe the display screen or the indicators on the printer.

Answer only the question that applies to the type of work station that you just powered on.

- For all display stations except the IBM 3180 Model 2, see the following illustration. Does the cursor remain in the upper right corner of the display screen?



This line appears on IBM 3179 or IBM 3196 display screens while in offline mode.

- For an IBM 3180 Model 2 display station, see the following illustration. Does this display remain on the display screen?

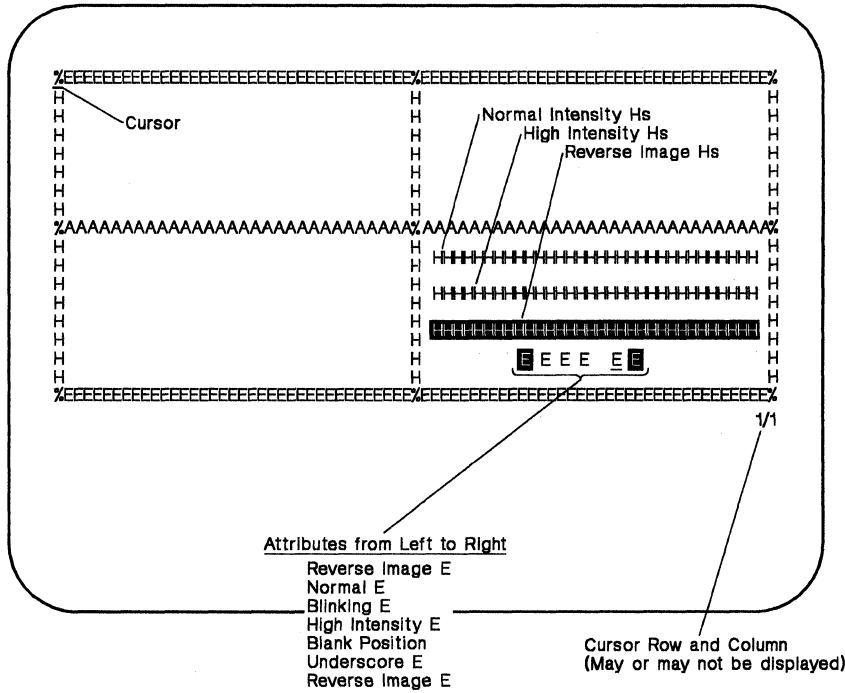

- For a printer or other type of work station, do the indicators show that power on was successfully completed? (Refer to the appropriate work station operator's guide for the indicators.)

**YES** - Go to step 22 on page 87.

**NO** - Go to step 21.

**Step 21** Make sure that any interconnecting cables between units of the failing display station or printer (such as keyboard cables) are correctly and securely connected.

If no problem is found with the cables, use the display station or printer problem determination procedures to isolate the failure.

**End of procedure.**

**Step 22** Refer to the Remote Work Station Setup Worksheet for the port with the failing work station. Check all work stations connected to this port for the following:

- All cables are attached correctly.
- Cabling to the last work station is terminated correctly.
- Only the last work station is terminated.
- All work station addresses are set correctly.

Your work station operator's guide or setup book contains instructions for setting addresses and terminating work stations.

Were any problems found?

**YES** - Correct the problem, and set the work station power switch to off and then to on. Set the control unit power switch to off (O) and then to on (I). Go to step 23.

**NO** - Go to step 24.

**Step 23** Is the System Available indicator on continuously at the work station?

**YES** - Establish normal operation.

**End of procedure.**

**NO** - Go to step 24.

**Step 24** Set the control unit power switch to off (O). Set the Test switch on the control unit to On. Set the control unit power switch to on (I). Find a display station that has a System Available indicator on. Follow the instructions in Chapter 4, "Configuring Your System" on page 31 to display the configuration screen.

Are any E's displayed on the upper portion of the screen?

**YES** - Too many work stations are attached to the control unit. Contact your network planner to determine if you have the wrong model control unit or if you should disconnect extra work stations.

**End of procedure.**

**NO** - Go to step 25.

**Step 25** Are all work stations failing that are connected to the port with the failing work station?

**YES** - Contact your customer service representative and report SRC D13007.

**End of procedure.**

**NO** - Go to the problem determination procedures for the failing work station. Refer to your work station documentation.

**End of procedure.**

**Step 26** Is the Com Line Sync indicator on or blinking?

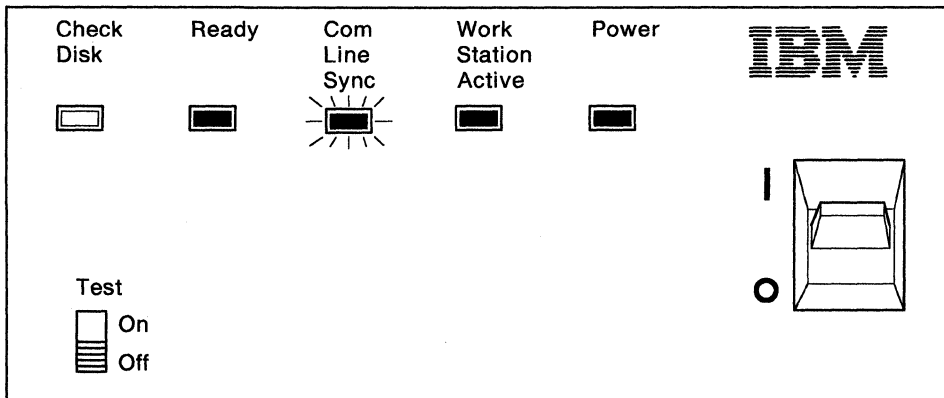

**YES** - Go to step 27.

**NO** - Go to step 29 on page 89.

**Step 27** Is a printer the only failing work station?

**YES** - Visually check the connecting cables for damage. If you find any damaged cables, have the cables repaired and establish normal operation.

Make sure that the cable connectors are securely connected to all the cables that connect the printer to the port.

Run the printer verification test. See "Running the Verification Tests" on page 97. If the test indicates equipment failure, contact your customer service representative.

**End of procedure.**

**NO** - Go to step 28.

**Step 28** Does a logon screen appear on the failing display station?

**YES** - Go to step 34 on page 90.

**NO** - Go to step 29 on page 89.

**Step 29** Contact the host system operator and ask if your control unit is online.

If your control unit is not online, have the host system operator bring your control unit online and retry the job.

If the host system operator has already brought your control unit online, have the host system operator bring your control unit offline and then online again.

Wait 30 seconds.

Does the logon screen appear on your display station?

**YES** - Go to step 33 on page 90.

**NO** - Go to step 30.

**Step 30** Have you tried to establish communication with the host system?

**YES** - Go to step 32.

**NO** - Go to Chapter 6, "Communicating with Your Host System" on page 63 and follow the procedure to establish communication with the host system. Attempt to establish normal operation. If unsuccessful, go to step 31.

**Step 31** Does the logon screen appear at the display station?

**YES** - Go to step 33 on page 90.

**NO** - Go to step 32.

**Step 32** Contact the host system operator and make sure that the work station is configured correctly at the host system.

Is the work station configured correctly at the host system?

**YES** - Run the extended test.

If your communication cable is EIA 232D or X.21 switched, see "Running the EIA 232D or X.21 Switched Extended Test Routine" on page 99.

If your communication cable is V.35, see "Running the V.35 Extended Test Routine" on page 107.

**End of procedure.**

**NO** - Have the host system operator correct the configuration. If the logon screen appears, establish normal operation. If the logon screen does not appear, run the extended test. See "Running the EIA 232D or X.21 Switched Extended Test Routine" on page 99.

**End of procedure.**



**Step 33** Can you log on to the host system?

**YES** - Call the host system operator and report that an intermittent failure occurred and that the failure was external to the control unit and attached work stations.

**End of procedure.**

**NO** - Call the host system operator and report that you have a logon screen but cannot log on.

**End of procedure.**

**Step 34** Do the characters displayed on your screen match the keys you pressed on your keyboard?

**YES** - Go to step 35.

**NO** - Follow the instructions in Chapter 4, "Configuring Your System" on page 31 to display the configuration screen. Does the keyboard code in Field 1 of the configuration screen match the keyboard code on your Remote Work Station Setup Worksheet? If the keyboard codes match, contact your customer service representative. If the keyboard codes do not match, follow the instructions for changing your configuration in Chapter 4. Establish normal operation.

**End of procedure.**

**Step 35** Is the problem related to a magnetic stripe reader or a selector light pen?

**YES** - Refer to the problem determination procedures in the appropriate work station operator's guide.

**End of procedure.**

**NO** - Go to step 36.

**Step 36** Do only certain jobs fail?

**YES** - Report the failing jobs to the host system operator.

**End of procedure.**

**NO** - The cause of the failure has not been identified. If a problem still exists, contact your customer service representative.

**End of procedure.**

---

## Problem Determination Flowchart

This flowchart provides a quick reference to the problem determination procedures beginning on page 78. The following symbols are used in the flowchart:

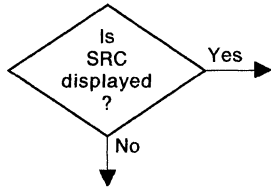

**Diamonds** indicate decision points. The answer to the question inside the diamond determines which branch of the flowchart you should follow. Arrows in the path line indicate the correct direction of flow.

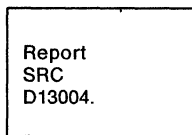

**Information blocks** contain instructions. Follow the instructions in each information block to continue the procedure.



**Lettered circles** indicate all entry points in the flowchart. A circle also indicates a departure point when the corresponding entry point is on the same page of the flowchart.



**Continuation flags** indicate departure points when the corresponding entry points are not on the same page.



**Numbered squares** correspond to steps in the problem determination procedures.

To use this flowchart with the problem determination procedures, do the following:

1. Enter the flowchart at the entry point (START) and answer the question in the decision point for step 1.
2. Follow the "Yes" or "No" path to the next information block or decision point.
3. Continue to follow the flowchart until you reach an information block that ends the path you are following. If you need more information at any point in the flowchart, go to the corresponding step in the problem determination procedures.

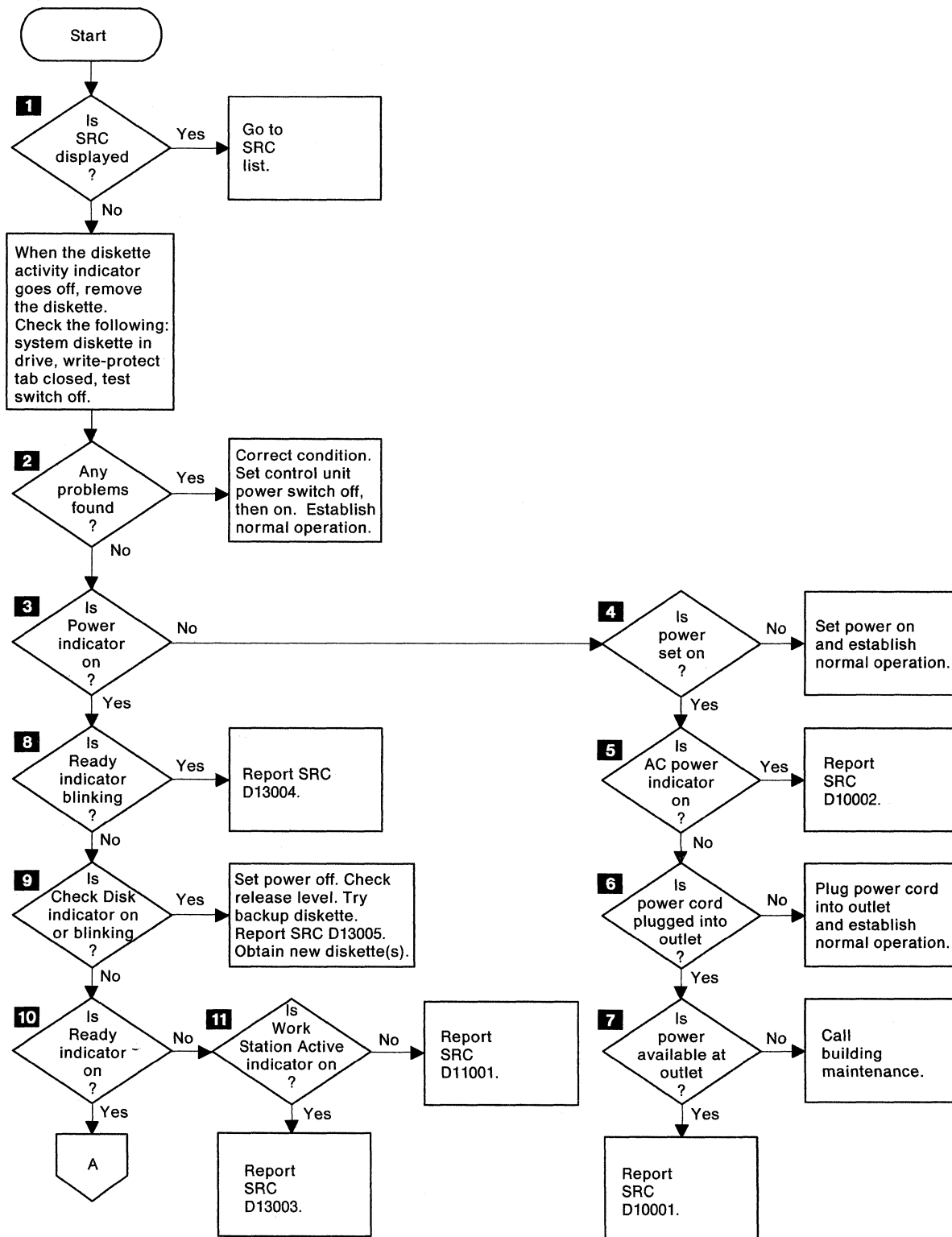

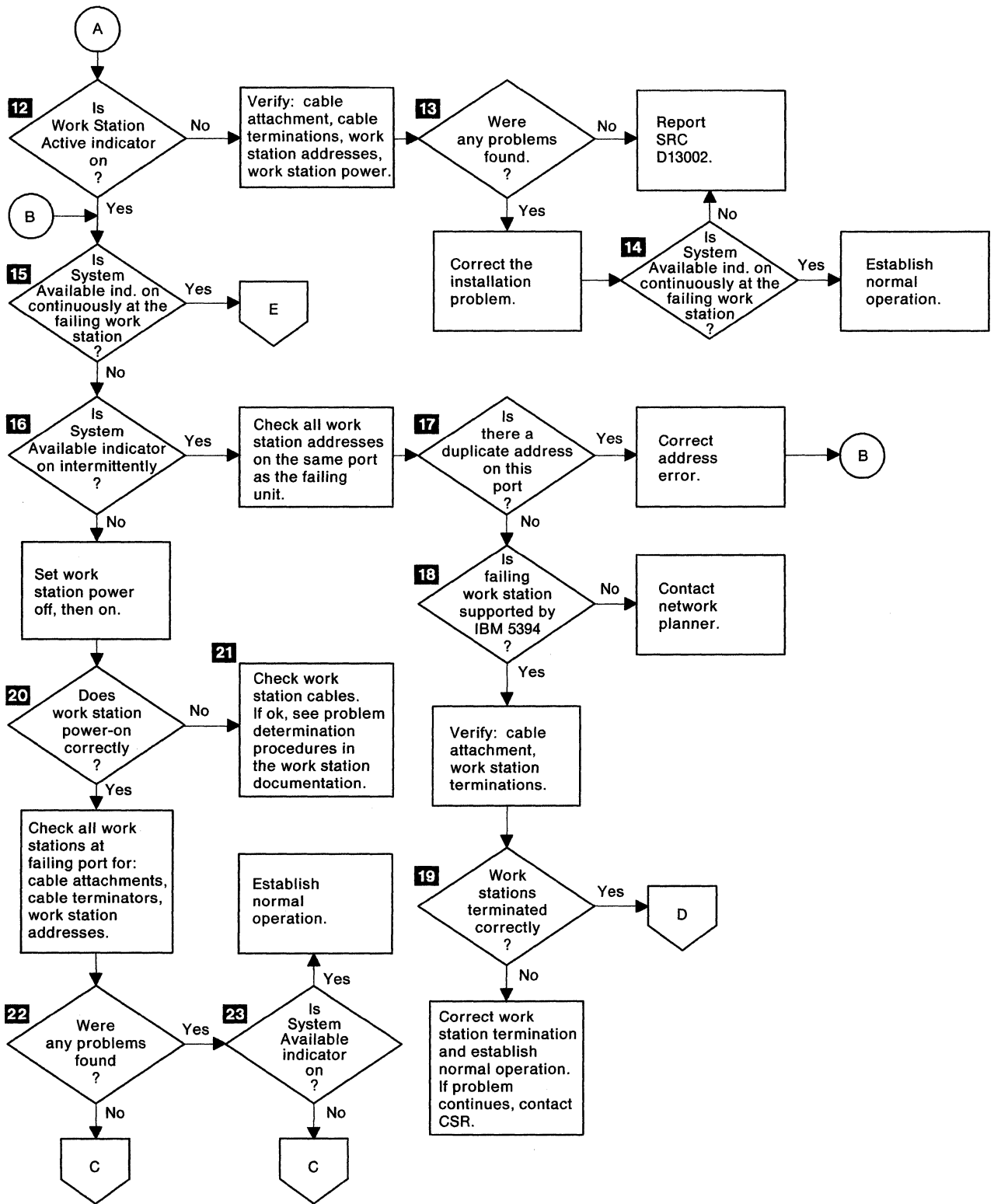

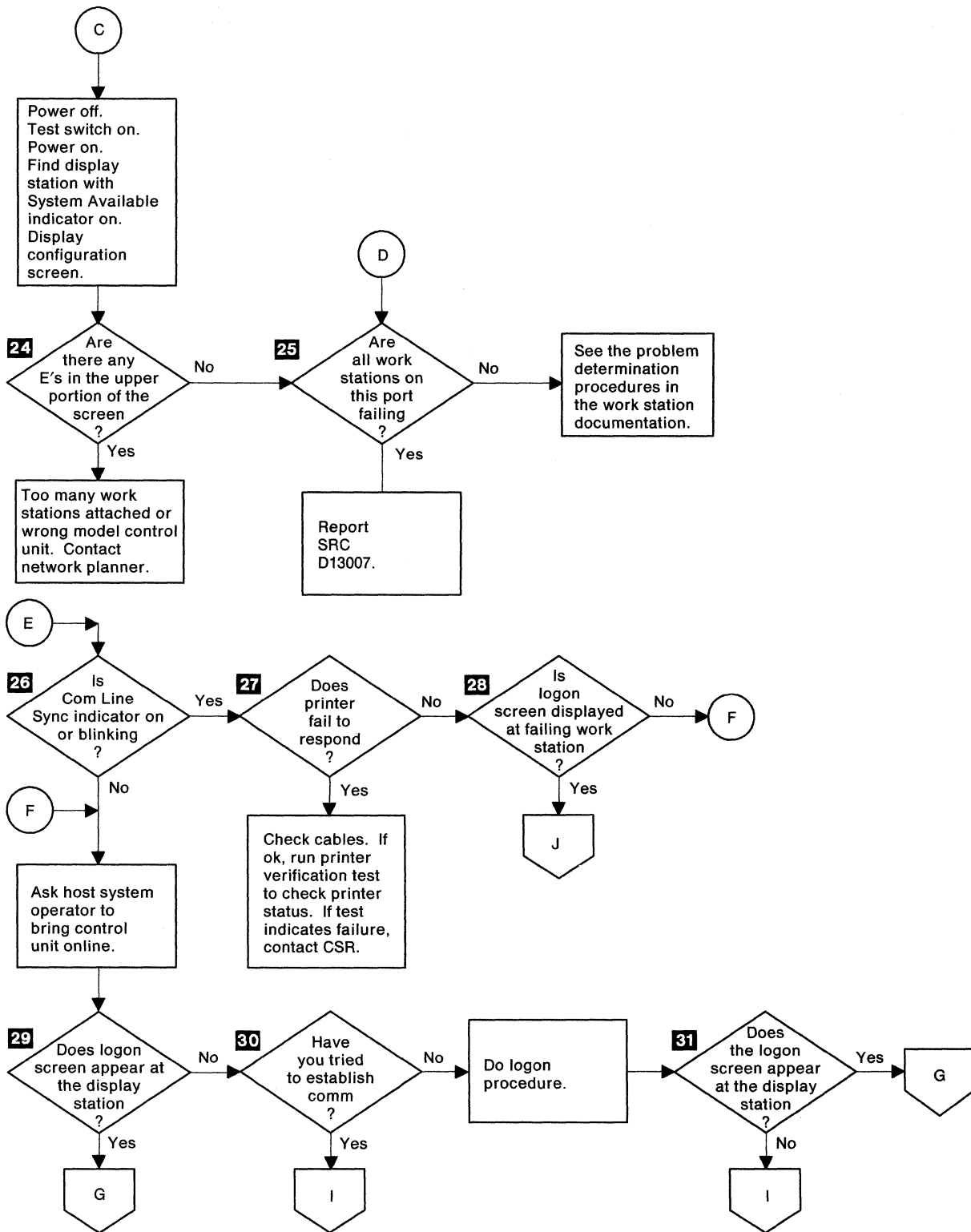

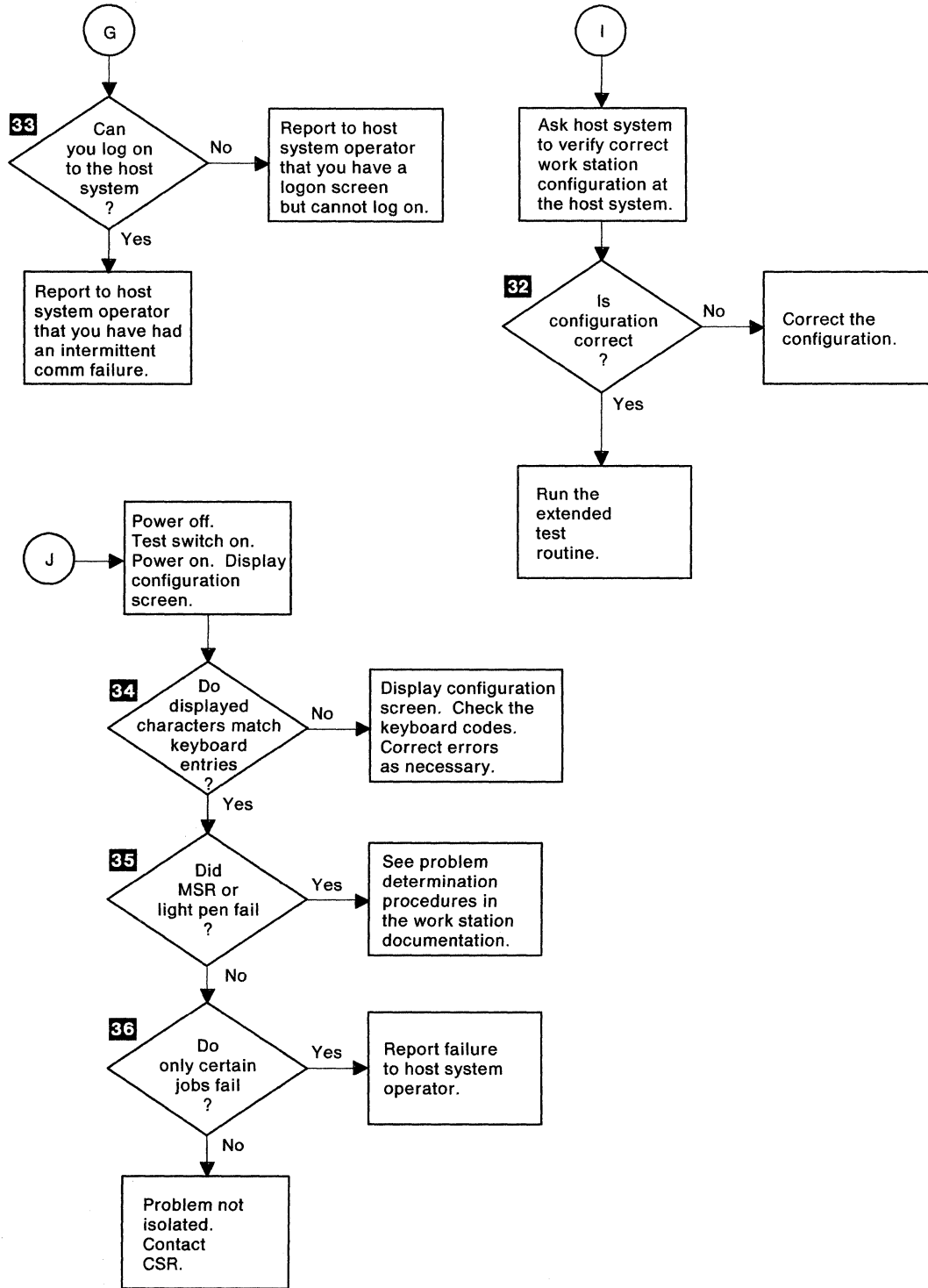



---

## Chapter 8. Running the Communication Tests

This chapter contains procedures for the following tests:

- Verification tests  
These tests check functions of the work stations.
- Extended test routine  
This test isolates problems on the communication network.

---

### Running the Verification Tests

The verification tests check some functions of the work stations.

Throughout these tests, you are required to make selections from a menu. If you make a selection error, the tests will not proceed. To recover from a selection error, you can:

- Backspace and enter the correct selection over the incorrect one (if you have not yet pressed the Enter key).
- Press the C key, then press the Enter key to return to the previous menu. Continue pressing these keys until the PRIME OPTION MENU screen appears. Then, you can make another selection.

Do the following to run the verification tests:

- Step 1** Make sure the Test switch is set to Off.
- Step 2** If necessary, start communication with the host system.
- Step 3** When the logon screen is displayed, press the Test Request key sequence. See Appendix F, "Key Sequences" on page 197 through page 204 for the correct sequence for your keyboard.

The PRIME OPTION MENU screen appears.

**Note:** The exact format of the display screens may vary from host system to host system.



```

PRIME OPTION MENU                SELECT OPTION                DISPLAY AB

C  END                            3  CONFIGURATION DATA
1  DISPLAY VERIFICATION           4  ERAP
2  WORK STATION PRINTER VERIFICATION

USE THE FOLLOWING LINES TO VERIFY CORRECT OPERATION OF KEYBOARD DATA KEYS

```

**Step 4** Select the desired option. See the following table for the correct key to press for each option.

Key	Option	Result
C	END	Returns you to the previous screen.
1	DISPLAY VERIFICATION	Provides test patterns that show various character display capabilities. A test is also run on the function keys.
2	WORK STATION PRINTER VERIFICATION	Tests a printer and provides a printed report showing print patterns for analysis.
3	CONFIGURATION DATA	Displays descriptive information, including addresses, for system devices.
4	ERAP	Displays or prints the errors that are stored in the host system for the IBM 5394 and attached work stations.

**Step 5** Press the Enter key.

Follow the instructions and prompts provided with each option.

For further information on these tests, refer to *IBM 5394 Remote Control Unit Maintenance Library*.

**Note:** See the appropriate work station operator's guide for operational requirements and meaning of SRCs.

---

## Running the EIA 232D or X.21 Switched Extended Test Routine

The following is a step-by-step procedure to isolate communication problems when using an EIA 232D communication cable or an X.21 switched communication cable.

If you are using a V.35 communication cable, go to "Running the V.35 Extended Test Routine" on page 107.

Before you run the extended test routine:

- Write down the displayed SRC if you have not already done so.
- Make sure that at least one display station is on.
- Make sure that the modem is set up correctly and is on.
- Make sure the communication cable is attached.

### Notes:

1. If the modem is not set up correctly or if you made any changes to the modem or DCE, do the following:
  - a. Set the control unit power switch to off (O).
  - b. Insert the system diskette into the diskette drive.
  - c. Set the control unit Test switch to Off.
  - d. Set the control unit power switch to on (I).
  - e. Retry the job. If the same failure occurs again, continue with the extended test routine.
2. If the modem is set up correctly or if you did not make any changes to the modem, continue with the extended test routine.

To run the extended test routine, do the following:

**Step 1** Make sure that all jobs are ended on all attached display stations and printers.

Set the control unit power switch to off (O).

**Step 2** Set the control unit Test switch to Off.

**Step 3** Set the control unit power switch to on (I).

The following indicators on the control unit should come on within 2 minutes.

- Power
- Ready
- Work Station Active.

The following indicators on all attached display stations should come on:

- Cursor **A** in the upper left corner of the display screen
- System Available indicator **B**.

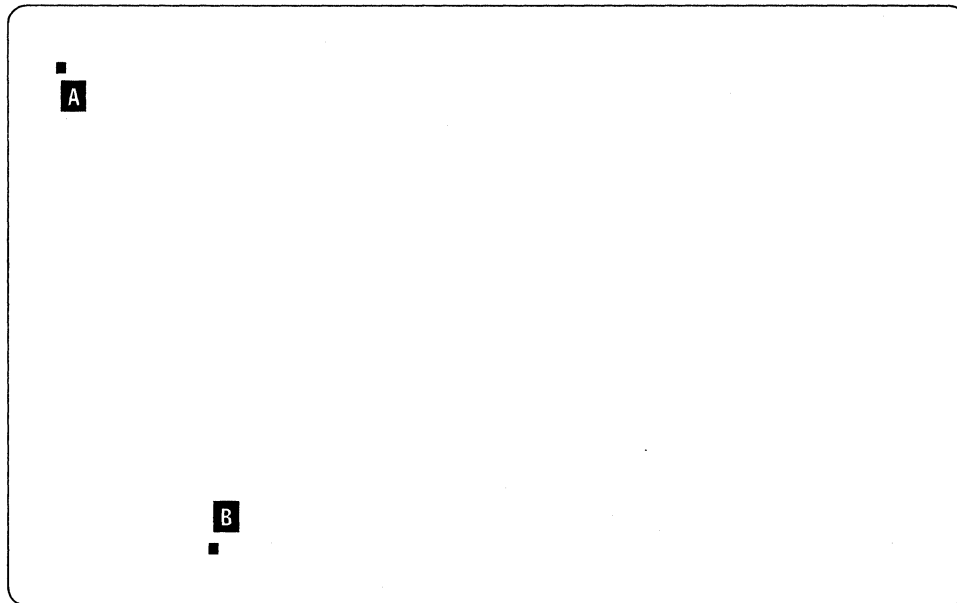

**Note:** Cursor style and System Available indicator position may be different on your display station screen.

If the correct indicators do not appear on at least one display station, go to Chapter 7, "Using the Problem Determination Procedures" on page 77.

**Step 4** Set the control unit Test switch to On.

**Step 5** At the display station closest to the control unit, press the Test Request key sequence. See Appendix F, "Key Sequences" on page 197 through page 204 for the correct sequence for your keyboard.

**Step 6** Press the D key.

**Note:** You can run this test from any display station except the following:

- IBM PC or Personal System/2 using AS/400 PC Support
- IBM PC AT or Personal System/2 using OS/2 Extended Edition 1.2
- IBM Personal System/55 using 5250 PC/2 AD Support.

However, using the display station nearest the control unit allows you to reach the switches easily.

The following information appears on the display screen within 5 seconds.

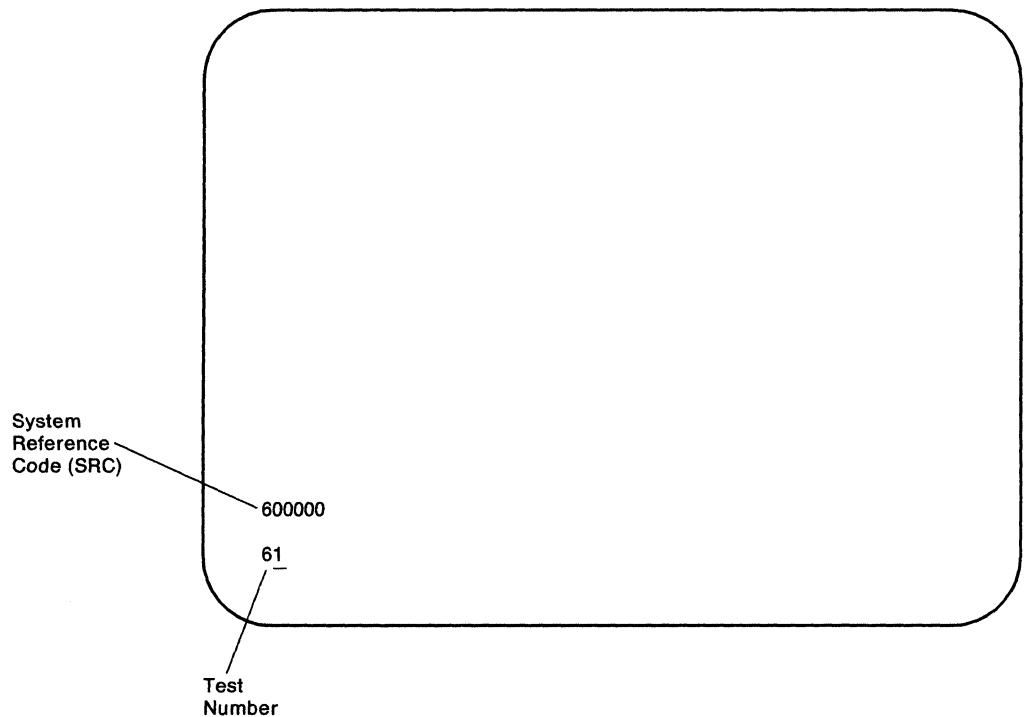

If the 600000 SRC does not appear, repeat steps 1 through 5.

If the 600000 SRC still does not appear, contact your customer service representative.

**Step 7** Press the Enter key.

The SRC on the display screen should change within 10 seconds.

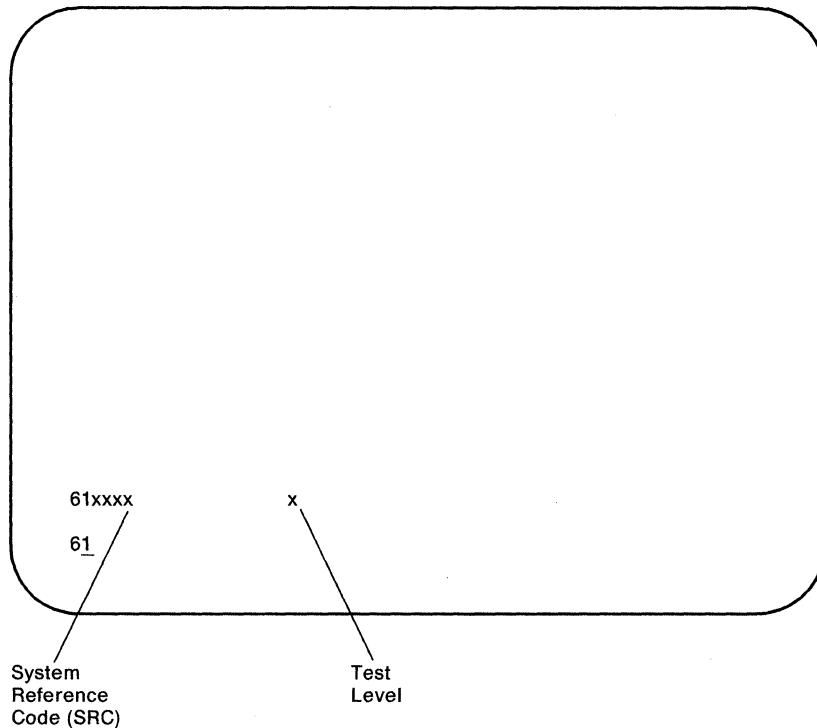

If the SRC does not change, press the Error Reset key and then press the Enter key.

If the SRC still does not change, contact your customer service representative.

If the SRC changes but the test number is not 61, press the Error Reset key. Use the Cursor Up or Cursor Down key to correct the test number. Then, press the Enter key.

**Step 8** Do the following:

- a. Observe the SRC displayed on the screen.
- b. Locate that SRC in the leftmost column of the table beginning on page 103. Follow the instructions for that code.

**Notes:**

- 1) The test-level digit appears only after the test sequence is completed.
- 2) SRCs are listed in numerical order. They may not appear on the screen in this order.
- 3) Before running the tests, determine which switches your modem or DCE uses for analog loopback, local loopback, digital loopback, and remote loopback. (Your modem or DCE may not have all four capabilities.) Refer to your modem or DCE operator's guide.

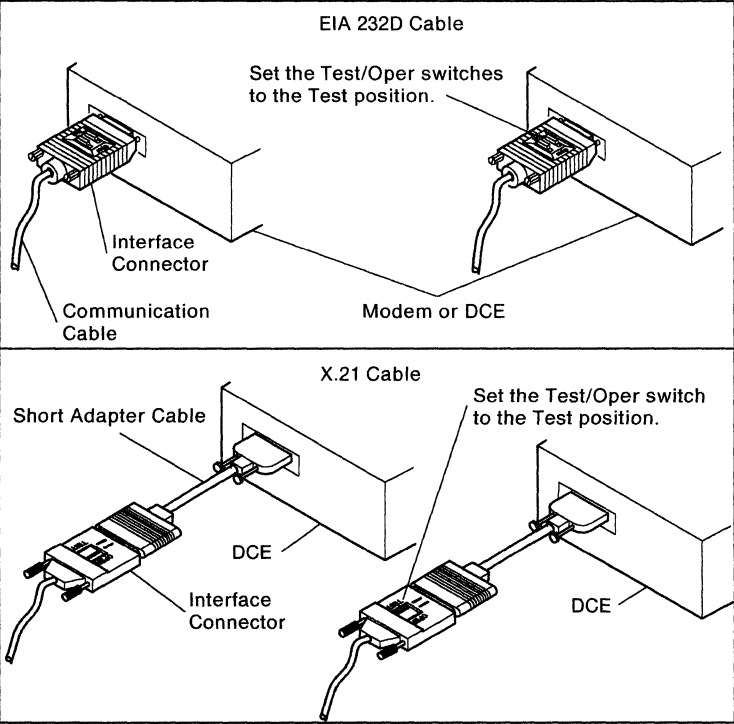
SRC	Test Level	Instructions
600000		You can run the selected test by pressing the Enter key.
610004		<ol style="list-style-type: none"> <li>1. Find your type of communication cable in one of the following illustrations.</li> <li>2. Locate the Test/Oper switches on your communication cable.</li> <li>3. Set the Test/Oper switches to TEST.</li> </ol> <div style="text-align: center;">  </div> <ol style="list-style-type: none"> <li>4. When the Test/Oper switches are in the TEST position, press the Enter key and wait 10 seconds for the next SRC to appear on the display screen.</li> <li>5. Set the Test/Oper switches to OPER.</li> <li>6. Locate the new SRC in this table and follow the instructions to continue the extended test routine.</li> </ol>
610005		<p>Make sure the Test/Oper switches on the communication cable are in the OPER position.</p> <p>If your modem or DCE has local loopback capabilities:</p> <ol style="list-style-type: none"> <li>1. Set the appropriate switch on the modem or DCE to select analog loopback or local loopback.</li> <li>2. At the display station, press the Enter key and wait 10 seconds for the next SRC to appear on the display screen.</li> <li>3. Go to the modem or DCE and return the switch that selects analog loopback or local loopback to the normal operating position.</li> <li>4. Locate the new SRC in this table and follow the instructions to continue the extended test routine.</li> </ol> <p>If your modem or DCE does not have loopback capabilities:</p> <ol style="list-style-type: none"> <li>1. At the display station, press the Error Reset key to skip the local loopback test. Wait 10 seconds for the next SRC.</li> <li>2. Locate the SRC in this table and follow the instructions to continue the extended test routine.</li> </ol>

SRC	Test Level	Instructions
610006		<p>If your modem or DCE has remote loopback capabilities:</p> <ol style="list-style-type: none"> <li>1. Set the modem or DCE to remote loopback.</li> <li>2. Press the Enter key and wait 10 seconds for the next SRC to appear on the display screen.</li> <li>3. Go to the modem or DCE and return the switch that selects remote loopback to the normal operating position.</li> <li>4. Locate the new SRC in this table and follow the instructions to continue the extended test routine.</li> </ol> <p>If your modem or DCE does not have remote loopback capabilities but the host system modem can loop (return) data back to the communication line:</p> <ol style="list-style-type: none"> <li>1. Have the host system operator set the host system modem to loop data back to the communication lines. <p style="margin-left: 40px;">If the host system is using an IBM 3872, 3874, or 3975 modem, have the host system operator set the host modem Test/Operate switch to the T3 position. For other modems, the Test/Operate switch is usually labeled digital loopback.</p> </li> <li>2. Press the Enter key and wait 10 seconds for the next SRC to appear on the display screen.</li> <li>3. Have the host system operator return the host system modem to normal operating mode.</li> <li>4. Locate the new SRC in this table and follow the instructions to continue the extended test routine.</li> </ol> <p>If neither the modem, the DCE, nor the host system modem have loopback capabilities:</p> <ol style="list-style-type: none"> <li>1. Press the Error Reset key.</li> <li>2. Locate the new SRC in this table and follow the instructions to continue the extended test routine.</li> </ol>

SRC	Test Level	Instructions
610007	ALL	<ol style="list-style-type: none"> <li>1. Write down the SRC and the test-level digit shown on the screen. Locate the test-level digit in this table.</li> <li>2. Exit the test mode by doing the following: <ul style="list-style-type: none"> <li>• Set the control unit power switch to off (O).</li> <li>• Set the control unit Test switch to Off.</li> <li>• If you changed any switch on the modem or DCE during the routine, return the switch to its normal operating position. In addition, if any switch was changed on the modem or DCE at the host site, have the host system operator return the switch to its normal operating position.</li> <li>• Make sure the Test/Oper switches on the communication cable are in the OPER position.</li> <li>• Set the control unit power switch to on (I).</li> </ul> </li> <li>3. If you ran the extended test routine because of an 004x or 005x SRC, locate the SRC in "Communication Network System Reference Codes" on page 161 and follow the recovery procedures.</li> <li>4. If you ran the extended test routine because you cannot establish communication with the host system and no SRC appeared on the screen, complete the test procedure as follows: <ul style="list-style-type: none"> <li>• If the test-level digit is 3, report to the host system operator that: <ul style="list-style-type: none"> <li>– A communication failure exists.</li> <li>– The control unit operates error free.</li> </ul> </li> <li>• If the test-level digit is 4, report to the host system operator that: <ul style="list-style-type: none"> <li>– A communication failure exists.</li> <li>– The control unit operates error free.</li> <li>– Local loopback runs successfully.</li> <li>– Remote loopback is not possible for this configuration.</li> </ul> </li> <li>• If the test-level digit displayed is a 6, report to the host system operator that: <ul style="list-style-type: none"> <li>– A communication failure exists and is probably caused by the host system.</li> <li>– The control unit operates error free.</li> <li>– The attached modem and the communication network operate correctly.</li> <li>– The host system modem successfully passed the remote loopback test.</li> </ul> </li> </ul> </li> </ol>



SRC	Test Level	Instructions
618xxx	ALL	<ol style="list-style-type: none"> <li>1. Write down the SRC and the test-level digit shown on the screen. Locate the test-level digit in this table.</li> <li>2. Exit the test mode by doing the following: <ul style="list-style-type: none"> <li>• Set the control unit power switch to off (O).</li> <li>• Set the control unit Test switch to Off.</li> <li>• If you changed any switch on the modem or DCE during the routine, return the switch to its normal operating position. In addition, if any switch was changed on the modem or DCE at the host site, have the host system operator return the switch to its normal operating position.</li> <li>• Make sure the Test/Oper switches on the communication cable are in the OPER position.</li> <li>• Set the control unit power switch to on (I).</li> </ul> </li> <li>3. If the test-level digit is 3, contact the customer service representative and report the SRC and test-level digit.</li> <li>4. If the test-level digit is 4, report to the host system operator that: <ul style="list-style-type: none"> <li>• The control unit is operating error free.</li> <li>• The modem or DCE attached to the control unit failed the local loopback test.</li> </ul> </li> <li>5. If the test-level digit is 6, report the following to the host system operator: <ul style="list-style-type: none"> <li>• The control unit is operating correctly.</li> <li>• The modem attached to the control unit successfully completed the local loopback test.</li> <li>• The remote loopback test to the host system modem failed.</li> <li>• The failure was caused by either the communication network or the host system.</li> </ul> </li> </ol>

---

## Running the V.35 Extended Test Routine

The following is a step-by-step procedure to isolate communication problems when using a V.35 communication cable. If you are using an EIA 232D communication cable or an X.21 switched communication cable, go to "Running the EIA 232D or X.21 Switched Extended Test Routine" on page 99.

Before you run the extended test routine:

- Write down the displayed SRC if you have not already done so.
- If your hardware is serial number 55000 or above in North America, South America, Australia, and the Far East, or 77001-BE or above in Europe, the Middle East, and Africa, your system diskette must be release level 2.1 or later. For all other hardware, your system diskette must be release level 1.1 or later.
- Make sure that at least one display station is on.
- Make sure that your modem or DCE is set up correctly.
- Make sure that the communication cable is attached.

### Notes:

1. If the modem is not set up correctly or if you made any changes to the modem or DCE, do the following:
  - a. Set the control unit power switch to off (O).
  - b. Insert the system diskette into the diskette drive.
  - c. Set the control unit Test switch to Off.
  - d. Set the control unit power switch to on (I).
  - e. Retry the job. If the same failure occurs again, continue with the extended test routine.
2. If the modem is set up correctly or if you did not make any changes to the modem, continue with the extended test routine.

To run the V.35 extended test routine, do the following:

**Step 1** Make sure that all jobs are ended on all attached display stations and printers. Set the control unit power switch to off (O).

**Step 2** Make sure that the control unit Test switch is in the Off position. Set the control unit power switch to on (I). The following indicators on the control unit should come on within 2 minutes:

- Power
- Ready
- Work Station Active.

The following indicators on all attached display stations should come on:

- Cursor **A** in the upper left corner of the display screen
- System Available indicator **B**.



**Note:** Cursor style and System Available indicator position may be different on your display station screen.

If the correct indicators do not appear on at least one display station, go to Chapter 7, "Using the Problem Determination Procedures" on page 77.

**Step 3** Set the control unit Test switch to On.

**Step 4** At the display station closest to the control unit, press the Test Request key sequence. See Appendix F, "Key Sequences" on page 197 through page 204 for the correct sequence for your keyboard.

**Step 5** Press the D key.

**Note:** You can run this test from any display station except the following:

- IBM PC or Personal System/2 using AS/400 PC Support
- IBM PC AT or Personal System/2 using OS/2 Extended Edition 1.2
- IBM Personal System/55 using 5250 PC/2 AD Support.

However, using the display station nearest the control unit allows you to reach the switches easily.

The following information appears on the display screen within 5 seconds.

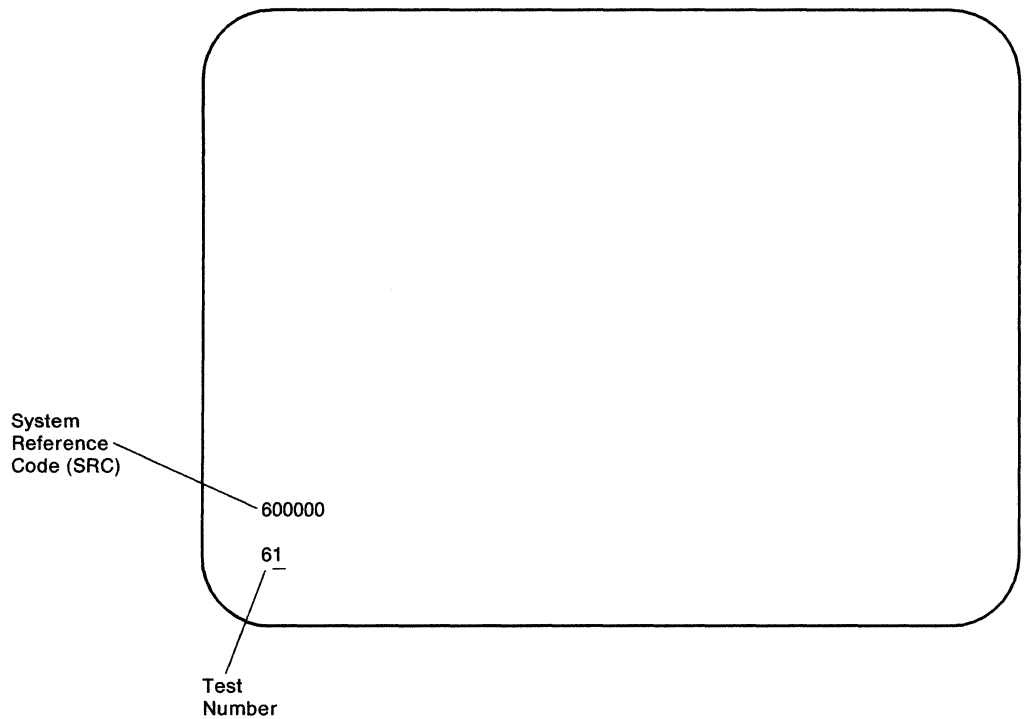

If the 600000 SRC does not appear, repeat steps 1 through 4.

If the 600000 SRC still does not appear, contact your customer service representative.

**Step 6** Press the Enter key.

The SRC on the display screen should change within 10 seconds.

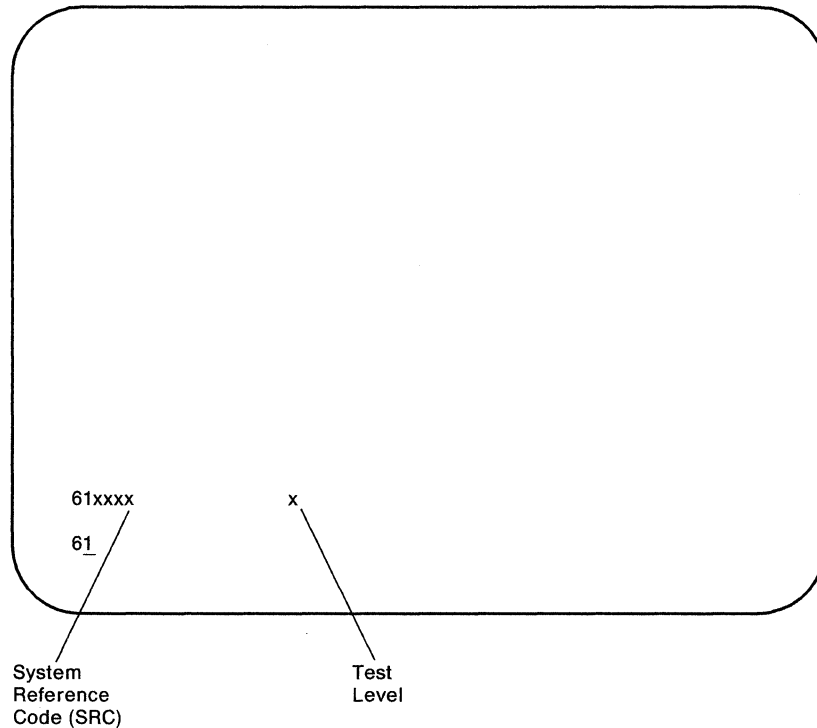

If the SRC does not change, press the Error Reset key and then press the Enter key.

If the SRC still does not change, contact your customer service representative.

If the SRC changes but the test number is not 61, press the Error Reset key. Use the Cursor Up or Cursor Down key to correct the test number. Then, press the Enter key.

**Step 7** Do the following:

- a. Observe the SRC displayed on the screen.
- b. Locate that SRC in the leftmost column of the following table. Follow the instructions for that code.

**Notes:**

- 1) The test-level digit appears only after the test sequence is completed.
- 2) SRCs are listed in numerical order. They may not appear on the screen in this order.
- 3) Before running the tests, determine which switches your modem or DCE uses for analog loopback, local loopback, digital loopback, and remote loopback. (Your modem or DCE may not have all four capabilities.) Refer to your modem or DCE operator's guide.

SRC	Test Level	Instructions
60000		Press the Enter key to start the test.
61000		The extended test is in progress.
61004	1	<ol style="list-style-type: none"> <li>1. Disconnect the communication cable from the modem or DCE.</li> <li>2. Locate the switch assembly near the end of the communication cable.</li> <li>3. Set switches 1 and 3 to the TEST position and switch 2 to the OPER position.</li> <li>4. Press the Enter key on your keyboard and wait 5 seconds for the next SRC to appear on the display station screen.</li> <li>5. Locate the new SRC in this table and follow the instructions to continue the test sequence.</li> </ol>
61004	2	<ol style="list-style-type: none"> <li>1. Locate the switch assembly near the end of the communication cable.</li> <li>2. Set switches 1 and 2 to the TEST position and switch 3 to the OPER position.</li> <li>3. Press the Enter key on your keyboard and wait 5 seconds for the next SRC to appear on the display station screen.</li> <li>4. Locate the new SRC in this table and follow the instructions to continue the test sequence.</li> </ol>
61005		<ol style="list-style-type: none"> <li>1. Make sure the communication cable is connected to the back of the modem or DCE and that all three switches are in the OPER position.</li> <li>2. If possible, set up your modem or DCE to run a local loopback test and press the Enter key.</li> <li>3. If your modem or DCE does not support local loopback, press the Error Reset key to bypass this test.</li> <li>4. Wait 5 seconds for the new SRC to appear on the display station screen. Locate that SRC in this table and follow the instructions to continue the extended test routine.</li> </ol>
61006		<ol style="list-style-type: none"> <li>1. If possible, set up your modem or DCE to run a remote loopback test and then press the Enter key.</li> <li>2. If your equipment does not support remote loopback: <ul style="list-style-type: none"> <li>• Set up your modem or DCE for normal operation.</li> <li>• Call your host system operator and request that the host system modem or DCE be set up to loop data back to the communication line.</li> <li>• Press the Enter key when the host system is ready for the test.</li> </ul> </li> <li>3. If you were not able to complete either of the above instructions, press the Error Reset key to exit this test.</li> <li>4. Wait for the next SRC to appear on screen. Locate the new SRC in this table and follow the instructions to complete the extended test routine.</li> </ol>

SRC	Test Level	Instructions
610007	ALL	<p>The test sequence ran without detecting any failure. Do the following:</p> <ol style="list-style-type: none"> <li>1. Write down the SRC and test-level digit that appear on the screen.</li> <li>2. Exit the test mode as follows: <ul style="list-style-type: none"> <li>• Set the control unit power switch to off (O).</li> <li>• Set the control unit Test switch to Off.</li> <li>• Make sure that your modem or DCE is set up for normal operation.</li> <li>• Make sure that the communication cable is attached to the modem or DCE and that all three switches are in the OPER position.</li> <li>• Set the control unit power switch to on (I).</li> </ul> </li> <li>3. If you ran the extended test because of an 004X or 005X SRC, locate that SRC in Appendix E, "System Reference Codes" on page 153 and follow the recovery procedure given there.</li> <li>4. If you ran the extended test because you could not establish communication with the host system and no SRC appeared on the screen, take the action corresponding to the test-level digit that you recorded in step 1 in this table. <ul style="list-style-type: none"> <li>• If test level is 3, report to the host system operator that a communication problem exists. The problem does not appear to be in the control unit.</li> <li>• If test level is 4, report to the host system operator that: <ul style="list-style-type: none"> <li>– A communication problem exists.</li> <li>– The problem does not appear to be in the control unit.</li> <li>– The local loopback test passed.</li> <li>– Remote loopback is not possible for this configuration.</li> </ul> </li> <li>• If test level is 6, report to the host system operator that: <ul style="list-style-type: none"> <li>– A communication problem exists.</li> <li>– The problem does not appear to be in the control unit.</li> <li>– The local loopback test passed.</li> <li>– The remote loopback test passed.</li> </ul> </li> </ul> </li> </ol>

SRC	Test Level	Instructions
618DXX 618EXX 618FXX	ALL	<p>The extended test sequence has detected a communication failure. Do the following:</p> <ol style="list-style-type: none"> <li>1. Write down the SRC and test-level digit that appear on the screen.</li> <li>2. Exit the test mode as follows: <ul style="list-style-type: none"> <li>• Set the control unit power switch to off (O).</li> <li>• Set the control unit Test switch to Off.</li> <li>• Make sure that your modem or DCE is set up for normal operation.</li> <li>• Make sure that the communication cable is attached to the modem or DCE and that all three switches are in the OPER position.</li> <li>• Set the control unit power switch to on (I).</li> </ul> </li> <li>3. Take one of the following actions, depending on the test-level digit that you recorded in step 1 in this table. <ul style="list-style-type: none"> <li>• If test level is 3, report the SRC and test-level digit to your customer service representative.</li> <li>• If test level is 4, contact your host system operator and report: <ul style="list-style-type: none"> <li>– A communication problem exists.</li> <li>– The problem does not appear to be in the control unit.</li> <li>– The attached modem or DCE failed the local loopback test.</li> </ul> </li> <li>• If test level is 6, contact your host system operator and report: <ul style="list-style-type: none"> <li>– A communication problem exists.</li> <li>– The problem does not appear to be in the control unit.</li> <li>– The attached modem or DCE passed the local loopback test.</li> <li>– The remote loopback test failed.</li> <li>– The failure was caused either by the communication network or by the host system.</li> </ul> </li> </ul> </li> </ol>





## Appendix A. Preparing the Communication Worksheet

This appendix provides a step-by-step guide for completing the Communication Worksheet.

The worksheet you complete depends on the physical interface and line type your communication network uses. Refer to the following table to determine which Communication Worksheet you need. Before you begin, make a copy of the appropriate blank worksheet in Appendix C, "Worksheets" on page 139.

<b>If you have this interface:</b>	<b>And this line type:</b>	<b>Complete this worksheet:</b>
EIA 232D (CCITT V.24/V.28) or CCITT V.35	Analog Switched or Nonswitched	SDLC Communication Worksheet – Go to page 116.
CCITT X.21 bis (V.24/V.28 or V.35)	X.21 Public Data Network Switched or Nonswitched	SDLC Communication Worksheet – Go to page 116.
CCITT X.21	X.21 Public Data Network Nonswitched	SDLC Communication Worksheet – Go to page 116.
CCITT X.21	X.21 Public Data Network Switched	X.21 Switched Communication Worksheet – Go to page 124.
CCITT X.21 bis (V.24/V.28 or V.35)	X.25 Packet-Switched Public Data Network	X.25 Communication Worksheet – Go to page 119.
CCITT X.21	X.25 Packet-Switched Public Data Network	X.25 Communication Worksheet – Go to page 119.

# SDLC Communication Worksheet

Complete this worksheet for SDLC communication.

## SDLC Communication Worksheet Example

See "Instructions for Completing the SDLC Communication Worksheet" on page 117.

IBM 5394 SDLC Communication Worksheet	
<b>A</b> Host system type and location	_____
<b>B</b> IBM 5394 model number	_____
<b>C</b> IBM 5394 location	_____
<b>D</b> IBM 5394 SDLC station address	_____
<b>E</b> Modem or DCE model number	_____
<b>F</b> Modem configuration information (Fill in the blank or circle the appropriate choice in each column):	
<b>F1</b> Modem or DCE type	_____
<b>F2</b> Half-duplex	Duplex
<b>F3</b> Multipoint (or fan-in/out modem)	Point-to-point
<b>F4</b> NRZI	NRZ
<b>F5</b> DTR	CDSTL
<b>F6</b> Leading pad not required	Leading pad
<b>F7</b> Local loopback not supported	Local loopback
<b>G</b> V.25 bis auto-dial option information (Complete <b>G1</b> and <b>G2</b> if you selected auto-dial switched in <b>F1</b> .)	
<b>G1</b> V.25 bis timeout (in seconds)	_____
<b>G2</b> V.25 bis call information saved to diskette	Call information not saved
<b>Send the completed worksheet to the remote location to ensure correct installation of the IBM 5394 Remote Control Unit.</b>	

## Instructions for Completing the SDLC Communication Worksheet

**A** Fill in the name and location of your IBM host system. The IBM 5394 is supported by:

- IBM AS/400 system
- IBM System/36
- IBM System/38.

If you have a switched line, your IBM 5394 can communicate with more than one host system. Fill out a separate worksheet for each host system. Make sure the information in **E** is the same on all worksheets.

**B** Enter the model number of your IBM 5394.

**C** Fill in the location of the IBM 5394.

**D** Fill in the station address of your IBM 5394. Valid entries are X'01' to X'FE'. This must be the same as the address used by the host system to identify this control unit.

**E** Fill in the modem or DCE model number.

**F** Answer the following questions. Fill in the blank or circle the appropriate choice in lines **F1** through **F7** on your worksheet.

If you are purchasing a modem, refer to your modem documentation or contact your modem supplier to obtain the necessary information.

If your network supplier is providing the modem or DCE, contact your network supplier.

**Note:** If your IBM 5394 is a Model 02, you only need to circle the appropriate choice in **F3** on your worksheet.

**F1** Fill in the modem or DCE type. Choose one of the following:

- Nonswitched
- Manual-dial switched
- Auto-dial switched (V.25 bis)

Auto-dial switched is available for Release 2 or later.

**F2** Is your modem set to half-duplex or duplex?

**F3** Is your communication line multipoint or point-to-point?

### Notes:

1. If you are using a modem that provides DTE interface fan-in/out, such as the IBM 5865 Model 3, and you are using a point-to-point line to attach several IBM 5394 control units to your host system, circle multipoint.
2. If your modem is set to duplex and you are selecting point-to-point for **F3**, your modem must be configured to provide a constant RFS signal. The IBM 5394 sets RTS permanently on.

**F4** Does your modem documentation recommend nonreturn to zero inverted (NRZI) or nonreturn to zero (NRZ) encoding? This must match the configuration information for NRZI/NRZ at the host site. If no recommendation is made, circle NRZI.

**Note:** If your IBM 5394 Model 01 is attached to an X.21 network, circle NRZ.

**F5** Does your modem use interface pin 20 for Data Terminal Ready (DTR) or Connect Data Set to Line (CDSTL)?

**Note:** In the U.S.A. and Canada, circle DTR.

**F6** Does your modem require a leading pad prior to the SDLC flag? This must match the configuration at the host site.

**Note:** If your IBM 5394 Model 01 is attached to an X.21 network, circle leading pad not required.

**F7** Does your modem support local loopback initiated by interface pin 18?

**G** Complete this section if you selected auto-dial switched (V.25 bis) in **F1**. V.25 bis is available for Release 2 or later.

**G1** Fill in the maximum number of seconds allowed to establish a call connection when using V.25 bis. Valid entries are X'01' to X'FF'. The default value is 60 seconds (X'3C').

**G2** If your modem supports V.25 bis, should the call information (phone number) be saved on the IBM 5394 system diskette and redisplayed each time a V.25 bis auto-dial call is attempted? (You may choose not to save the phone number for security reasons.)

**The SDLC Communication Worksheet is complete.** Send the completed worksheet to the remote site to ensure correct installation of the IBM 5394.

---

## **X.25 Communication Worksheet**

Complete this worksheet for X.25 communication.

### **X.25 Communication Worksheet Example**

See "Instructions for Completing the X.25 Communication Worksheet" on page 121.

**IBM 5394 X.25 Communication Worksheet**

**A** Host system type and location \_\_\_\_\_

**B** IBM 5394 model number \_\_\_\_\_

**C** IBM 5394 location \_\_\_\_\_

**D** IBM 5394 station address \_\_\_\_\_

**E** X.25 subscription data:

**E1** Packet level sequence numbering (Modulo 8 or Modulo 128)

**E2** Packet window size \_\_\_\_\_

**E3** Link window size \_\_\_\_\_

**F** X.25 configuration data:

**F1** Packet size (64 bytes, 128 bytes, 256 bytes, or 512 bytes)

**F2** Circuit type \_\_\_\_\_

**F3** Flow control negotiation allowed (yes or no)

**F4** Manual options allowed (yes or no)

**F5** Local loopback supported (yes or no)

**G** X.25 software data:

**G1** Reverse charging accepted (yes or no)

**G2** Logical link control (PSH, QLLC, or ELLC)

**G3** Special network attachment (yes or no)

**G4** Link initialization control (network only or network and control unit)

**G5** Network subscription (1984 or 1980)

**G6** Diagnostics code (1984 SNA, 1984 ISO, or 1980 SNA)

**H** Retry parameters:

**H1** Number of retries \_\_\_\_\_

**H2** Seconds between retries \_\_\_\_\_

**Send the completed worksheet to the remote site to ensure correct installation of the IBM 5394 Remote Control Unit.**

## Instructions for Completing the X.25 Communication Worksheet

**A** Fill in the name and location of your IBM host system. The IBM 5394 is supported by:

- IBM AS/400 system
- IBM System/36
- IBM System/38.

If you have a switched virtual circuit (SVC) or multiple permanent virtual circuits (PVCs), you can attach the IBM 5394 to more than one host system. Fill out a separate worksheet for each host system. Make sure the information in **E**, **F**, **G**, and **H** is the same on all worksheets.

**B** Enter the model number of your IBM 5394.

**C** Fill in the location of the IBM 5394.

**D** Fill in the station address of your IBM 5394. Valid entries are X'01' to X'FE'. This must be the same as the address used by the host to identify this control unit.

**E** This information depends on your X.25 network subscription. Contact your network supplier for this information.

**E1** Circle the packet sequence numbering scheme your network uses. The IBM 5394 supports modulo 8 and modulo 128.

**E2** Enter the packet window size. If you selected modulo 8 in **E1**, valid entries are X'2' to X'7'. If you selected modulo 128, valid entries are X'2' to X'F'.

**E3** Enter the link window size. Valid entries are X'1' to X'7'.

**F** Select the appropriate value for lines **F1** through **F5**.

**F1** Circle one of the following packet sizes:

- 64 bytes
- 128 bytes
- 256 bytes
- 512 bytes (Release 2 or later).



Consider the following when selecting this value:

- If your IBM 5394 uses only one virtual circuit, enter the number for the packet size of that virtual circuit.
- If your IBM 5394 uses more than one PVC, but no SVC, enter the number for the packet size used most often.
- If your IBM 5394 uses both PVC and SVC, and flow control negotiation is not provided, enter the number for the packet size of the SVC.
- If your IBM 5394 uses both PVC and SVC, and flow control negotiation is provided, enter the number for the packet size used most often.

**F2** Enter the circuit type for your subscription. Valid entries are:

- Single PVC
- Single SVC (answer only)
- Single SVC (call allowed)
- Multiple PVCs
- Multiple SVCs.

**Note:** Your subscription may include multiple PVCs or multiple SVCs. However, the IBM 5394 communicates on only one assigned channel at a time. Packets arriving on a channel other than the assigned channel are discarded with no response.

**F3** Does your subscription include the flow control negotiation facility?

**F4** Circle yes if you would like to allow the operator to enter all keyboard entered (manual) options when opening a PVC, placing a call on an SVC, or answering a call on an SVC. Circle no if the network address, the logical channel ID, and the password are the only options the operator needs to enter.

**Notes:**

1. If **F2** is set for a single PVC or single SVC (answer only), and **F4** is set for manual options not allowed, the link is automatically initialized when the control unit power switch is set to on (I).
2. If the packet size or window size options are used on an SVC, you must subscribe to the flow control negotiation facility (**F3**).

**F5** Does your DCE support local loopback initiated by interface pin 18?

**G** This information specifies some of the software selectable X.25 information. For a complete discussion of IBM's implementation of X.25 recommendations, refer to *The X.25 Interface for Attaching SNA Nodes to Packet-Switched Data Networks General Information Manual*.

Circle the correct choice for each item.

**G1** Do you subscribe to the reverse charging facility?

**G2** Which logical link control (LLC) facility will you be using? Valid entries are:

- Physical services headers (PSH)
- Qualified logical link control (QLLC)
- Enhanced logical link control (ELLC).

**Note:** This must be the same as the LLC used by your host system.

**G3** Will the IBM 5394 be attached to a Telenet-type network? Telenet-type networks will expect the IBM 5394 to respond with UNNUMBERED ACKNOWLEDGMENT (UA) when polled with the DISCONNECT (DISC) command before sending Set Asynchronous Balanced mode (SABM). If the IBM 5394 will not be attached to a Telenet-type network, it will respond with Disconnect mode (DM) to a DISC received before sending SABM.

**G4** Will the IBM 5394 be attached to a network that requires that the link initialization be done by the network only, or can link initialization be done by either the control unit or the network?

**G5** Which CCITT X.25 Recommendation must the IBM 5394 support? Valid entries are a 1980 subscription or a 1984 subscription.

**G6** Which format of diagnostics codes will be used by the IBM 5394? Valid entries are:

- 1984 Systems Network Architecture (SNA) format diagnostics codes.
- 1984 International Standards Organization (ISO) format diagnostics codes.
- 1980 SNA format diagnostics codes.

**Notes:**

1. If **G5** is set for 1980 subscription, **G6** must be set for 1980 SNA format diagnostic codes.
2. The diagnostic code format of the IBM 5394 must match the host site.

**H** Enter the following information used by the IBM 5394 for retries:

**H1** Enter the number (in hexadecimal) of attempts the IBM 5394 makes to solicit a response from the DCE to a transmitted frame (N2<sup>4</sup>). Valid entries are X'00' to X'FF'. The default number is 10 (X'0A'). Your network supplier may impose restrictions on this value to limit network congestion.

**H2** Enter the time (in seconds) the IBM 5394 waits before timing out for a response to a transmitted frame (T1<sup>4</sup>). Valid entries are X'01' to X'3C'. The default is 3 seconds (X'03'). This value may also be restricted. Contact your network supplier for restrictions.

**The X.25 Communication Worksheet is complete.** Send the completed worksheet to the remote site to ensure correct installation of the IBM 5394.

---

<sup>4</sup> CCITT X.25 Recommendation parameter

## X.21 Switched Communication Worksheet

Complete this worksheet for X.21 switched communication.

### X.21 Switched Communication Worksheet Example

See "Instructions for Completing the X.21 Switched Communication Worksheet" on page 125.

#### IBM 5394 X.21 Switched Communication Worksheet

- A** Host system type and location \_\_\_\_\_
- B** IBM 5394 model number \_\_\_\_\_
- C** IBM 5394 location \_\_\_\_\_
- D** IBM 5394 SDLC station address \_\_\_\_\_
- E** X.21 network ID# \_\_\_\_\_
- F** Short Hold mode (SHM) retries:
- F1** Number of retries \_\_\_\_\_
- F2** Delay between retries \_\_\_\_\_
- F3** Direct (yes or no) call support
- G** Retry of optional call progress signals:
- \_\_\_\_\_
- \_\_\_\_\_

**Send the completed worksheet to the remote site to ensure correct installation of the IBM 5394 Remote Control Unit.**

## Instructions for Completing the X.21 Switched Communication Worksheet

**A** Fill in the name and location of your IBM host system. The IBM 5394 is supported by:

- IBM AS/400 system
- IBM System/36
- IBM System/38.

You can attach the IBM 5394 to more than one host system. Fill out a separate worksheet for each host system. Make sure the information in **F** and **G** is the same on all worksheets.

**B** This worksheet is valid only for IBM 5394 Model 02. If you do not have a Model 02, see the table on page 115 to determine the correct communication worksheet for your IBM 5394.

**C** Fill in the location of the IBM 5394.

**D** Once the switched circuit is established, the control unit uses SDLC for data transmission. Fill in the SDLC station address of your IBM 5394. Valid entries are X'01' to X'FE'. This must be the same as the address used by the host to identify this control unit.

**E** Fill in the X.21 network ID # (IBM 5394 telephone number). Your network supplier will provide you with this number. It can be from 1 to 15 decimal digits.

**F** Enter the following information used by the IBM 5394 to do Short Hold mode (SHM) retries. Do not enter information if SHM is not used.

**F1** Enter the number of retries that you want your IBM 5394 to make to reestablish the link to the host during SHM operations. Valid entries are X'00' to X'FF'. The default is five (X'05'). Your network supplier may impose restrictions on this value.

**F2** Enter the number of seconds between retry attempts during SHM. Valid entries are X'1' to X'F'. This value may also be restricted by your network supplier to alleviate network congestion. The default is 6 seconds (X'06'). To limit network congestion, make sure that the time between retries on your IBM 5394 is greater than the time between retries on your host system.

**F3** Circle yes if the IBM 5394 will not use dial digits to initiate SHM reconnection (direct call support). Circle no if the IBM 5394 will use the host system XID dial digits to reestablish the link.

**G** During SHM link reestablishment, the IBM 5394 will automatically retry all 2x and 6x call progress signals (CPS) received from the network using the parameters specified in **F**. The IBM 5394 can retry other CPSs. You can specify retry of up to eight optional CPSs. Table 1 shows the CPSs that can be optionally retried. Since 2x and 6x codes are automatically retried, they are not included in this table.

Enter up to eight codes in space **G**.

*Table 1. Optional Call Progress Signals*

<b>Code</b>	<b>Significance</b>
01	Terminal called
02	Redirected call
03	Connect when free
04	Private network reached
05	Public network reached
41	Access barred
42	Changed number
43	Not obtainable
44	Out of order
45	Controlled not ready
46	Uncontrolled not ready
47	DCE power off
48	Invalid facility request
49	Network fault in local loop
51	Call information service
52	Incompatible user class of service
71	Long-term network congestion
72	RPOA out of order

**The X.21 Switched Communication Worksheet is complete.** Send the completed worksheet to the remote site to ensure correct installation of the IBM 5394.

---

## Appendix B. Preparing the Applications Worksheet

This appendix provides instructions for completing the Applications Worksheet. Complete this worksheet if:

- You are using V.25 bis auto-dial in SDLC communication mode (Release 2 or later)
- You are using X.25 communication mode
- You are using X.21 switched communication mode.

The Applications Worksheet allows you to record the application procedures needed to establish communication with the host system. Your system planner should provide the information for this worksheet. A blank worksheet is provided in Appendix C, "Worksheets" on page 139.



---

## SDLC Communication

Complete the Applications Worksheet for SDLC communication only if your system supports V.25 bis auto-dial.

Fill in **A**, **B**, and **C** on the Applications Worksheet. On line **D**, enter the number to be dialed, followed optionally by a semicolon (;) and the identification number of the calling data station. (Some countries require this ID.) If additional dial tones are required by your application, you may include separators, "wait tones," and so forth in the telephone number.



## X.25 Communication

This section describes three methods for establishing X.25 communication at the IBM 5394: PVC, SVC answer, and SVC call. Listed under each method are the required parameters followed by the optional ones. Fill in line **D** at the bottom of the Applications Worksheet with the required parameters. Then, fill in the optional parameters if options are allowed by the setup configuration and you want to override or supplement the setup information.

**Note:** Insert a comma between successive parameters on line **D**.

### PVC

If you have Release 2 or later and your configuration specifies single PVC operation and manual options are not permitted, no operator action is required to initiate communication following power-on or to reestablish communication following successful network link error recovery. If your configuration specifies single PVC operation and manual options are permitted, operator action is required to initiate communication following power-on. The operator options entered for link initialization are saved and used to reestablish communication following network link error recovery without further operator action. In all other cases, operator input is required to initiate or reestablish communication.

For PVC, the first parameter listed below is required. The other parameters are optional.

1. Enter 0 (alphabetic 0) on line **D**.
2. If your network subscription provides more than one logical channel, enter:  
L  
followed by a 3-character hexadecimal code to identify the logical channel to be used. Your planner or X.25 network supplier should provide this code. Valid logical channels are hexadecimal values 001 through FFF.
3. You can select the following options if the IBM 5394 setup configuration specifies that manual options are allowed:
  - To change from the configured logical link protocol to QLLC or ELLC, do one of the following:
    - If you want to change the logical link protocol to QLLC, enter:  
Q
    - If you want to change the logical link protocol to ELLC, enter:  
E  
followed by a three-digit number that defines the number in tenths of seconds for end-to-end error recovery. Valid values are 100 through 999. For example, 250 is 25 seconds. This value should be the same value used by the host system.

**Note:** You cannot select PSH logical link control as a manual option.

- To change the packet size, enter:

P

followed by the new packet size. Valid values are 064, 128, 256, or 512. (512 applies to Release 2 or later.)

- To change the packet window size, enter:

W

followed by a two-digit code. Valid values are 02 through 07 for modulo 8 or 02 through 15 for modulo 128.

**Note:** Insert a comma between successive parameters on line **D**.

The following worksheet shows an example of PVC parameters.

**APPLICATIONS WORKSHEET--OPERATOR'S INFORMATION**

**A** Setup instructions for the following applications:

    Payroll      
      Inventory Update    
        Time Cards      
    \_\_\_\_\_

**B** Host Contact   E.P. Barton  

**C** Telephone   287-1956  

1. Press the System Request key sequence. See Appendix F, Key Sequences in the *IBM 5394 Remote Control Unit User's Guide* for the correct sequence for your keyboard.
2. Enter the following as one line:

**D**

O	,	L	0	0	1	,	E	1	0	0	,	P	0	6	4	,	W
0	7																

3. Press Enter.

## SVC Answer at the IBM 5394

If you have Release 2 or later and your configuration specifies single SVC (answer only) operation and manual options are not permitted, no operator action is required to initiate communication following power-on or to reestablish communication following successful network link error recovery. If your configuration specifies single SVC (answer only) operation and manual options are permitted, operator action is required to initiate communication following power-on. The operator options entered for link initialization are saved and used to reestablish communication following network link error recovery without further operator action. In all other cases, operator action is required to initiate or reestablish communication.

For SVC answer, the first parameter listed below is required. The other parameters are optional.

1. Enter A in the first space of line **D**. This is required.

2. To enter a network address, enter:

N

followed by the host network address. The address can be from 1 through 15 numeric characters.

If this parameter is entered, the IBM 5394 answers only the calls that originate from that address.

3. To enter a password, enter:

X

followed by the password. The password can be from 1 through 8 alphanumeric characters.

If this parameter is entered, the IBM 5394 answers only the calls that include this password.

4. If your network subscription provides more than one logical channel, you may enter:

L

followed by a 3-character hexadecimal code to identify the logical channel to be used. If the L is omitted, incoming calls will be accepted on any logical channel. Your planner or X.25 network supplier should provide this code. Valid logical channels are hexadecimal values 001 through FFF.

If you have PVCs and SVCs in the same network subscription, specify the L parameter to assure correct operation.

5. You can select the following options if the IBM 5394 setup configuration specifies that manual options and flow control negotiation are allowed:

- To change the packet size, enter:

P

followed by the new packet size. Valid values are 064, 128, 256, or 512. (512 applies to Release 2 or later.)

- To change the packet window size, enter:

W

followed by a two-digit code. Valid values are 02 through 07 for modulo 8 or 02 through 15 for modulo 128.



## SVC Call at the IBM 5394

For SVC call, the first two parameters listed below are required. The other parameters are optional.

1. Enter C in the first space of line **D**. This must be the first entry in the sequence.

2. Enter:

N

followed by the host network address. The address can be from 1 through 15 numeric characters. This is required.

In addition, you can enter the local network address of your IBM 5394. Your local address can also be from 1 through 15 numeric characters and is separated from the host address by a dash (-). This portion of the N parameter is optional.

3. To enter a password, enter:

X

followed by the password. The password can be from 1 through 8 alphanumeric characters.

4. If a logical channel other than 001 is required, enter:

L

followed by a 3-character hexadecimal code. The person responsible for the application program should provide this code. Valid logical channels are hexadecimal values 001 through FFF.

You can select the following options if the IBM 5394 setup configuration specifies that manual options are allowed:

1. If you are using the closed user group, enter:

U

followed by the closed user group ID, a two-digit numeric code.

2. If you are using reverse charging, enter:

R

**Note:** If your network does not conform to CCITT Recommendation X.25 for the facility selection codes for closed user group and/or reverse charging, you must use the general facility selection procedure (parameter F) to select these facilities.

3. You can select other optional facilities by entering:

F

followed by 2 characters that identify the facility and 2 or more characters for the parameter code. Valid characters are 0 through 9 and A through F.

The following examples show facilities defined by CCITT Recommendation X.25. For other facilities, you must obtain the facility code and parameter code from your planner or network supplier.

- To select a specific throughput class facility, enter:

F02

followed by two hexadecimal values. Valid values are 0 through 9 and A through F.

- To select an RPOA, enter:

F44

followed by the four-digit code for the RPOA you want to use.

4. To change the default logical link protocol to QLLC or ELLC, do one of the following:

- If you want to change the logical link protocol to QLLC, enter:

Q

- If you want to change the logical link protocol to ELLC, enter:

E

followed by a three-digit number that defines the time (in tenths of seconds) allowed for end-to-end error recovery. Valid values are 100 through 999. For example, 250 is 25 seconds. This value should be the same value used by the host system.

**Note:** You cannot manually select the PSH logical link protocol.

You can select the following options if the IBM 5394 setup configuration specifies that manual options and flow control negotiation are allowed:

1. To change the packet size, enter:

P

followed by the new packet size. Valid values are 064, 128, 256, or 512. (512 applies to Release 2 or later.)

2. To change the packet window size, enter:

W

followed by a two-digit code. Valid values are 02 through 07 for modulo 8 or 02 through 15 for modulo 128.

**Note:** Insert a comma between successive parameters on line **D**.

The following worksheet shows an example of SVC call parameters.

**APPLICATIONS WORKSHEET--OPERATOR'S INFORMATION**

**A** Setup instructions for the following applications:

Payroll  
Inventory Update  
Time Cards  
\_\_\_\_\_

**B** Host Contact E.P. Barton

**C** Telephone 287-1956

1. Press the System Request key sequence. See Appendix F, Key Sequences in the *IBM 5394 Remote Control Unit User's Guide* for the correct sequence for your keyboard.
2. Enter the following as one line:

**D**

C	,	N	2	3	8	4	2	5	8	3	-	4	7	1	3	9	8
---	---	---	---	---	---	---	---	---	---	---	---	---	---	---	---	---	---

9	4	,	X	P	A	S	S	W	O	R	D	,	L	0	0	5	,
---	---	---	---	---	---	---	---	---	---	---	---	---	---	---	---	---	---

R	,	F	0	2	0	A	,	Q	,	P	0	6	4	,	W	0	7
---	---	---	---	---	---	---	---	---	---	---	---	---	---	---	---	---	---

--	--	--	--	--	--	--	--	--	--	--	--	--	--	--	--	--	--

3. Press Enter.

**The Applications Worksheet is complete for X.25 communication.**

---

## X.21 Switched Communication

This section describes four types of communication: X.21 Direct Call, X.21 Address Call, X.21 Answer, and Changing Subscription Parameters. Depending upon the application, more than one of these may be used for a particular procedure.

You can initiate communication at the host system or at the IBM 5394 (remote) site.

Communication can be initiated at the IBM 5394 by either direct call or address call, depending upon your network subscription.

### X.21 Direct Call

Fill in **A**, **B**, and **C** on the Applications Worksheet. Although information is not entered on line **D**, the operator still has to do steps 1 through 3 on the Applications Worksheet.

### X.21 Address Call

Fill in **A**, **B**, and **C** on the Applications Worksheet. Enter the network address for the host system on line **D**.

### X.21 Answer

Fill in **A**, **B**, and **C** on the Applications Worksheet. No special action is necessary for X.21 answer communication. Communication is established as soon as the IBM 5394 is powered on and has been brought online at the host system.

### Changing Subscription Parameters

If you want to change the subscription parameters from those already defined by the network, write SUBSCRIPTION PARAMETER CHANGE on line **A**, fill in **B** and **C**, and enter the facility registration or cancelation information on line **D**.

This information is network dependent and can be obtained from your network supplier.

**The Applications Worksheet is complete for X.21 switched communication.**





---

## **Appendix C. Worksheets**

This appendix contains blank copies of the following worksheets:

- Remote Work Station Setup Worksheet

For instructions on completing this worksheet, see "Completing the Remote Work Station Setup Worksheet" on page 9.

- Communication Worksheets

For instructions on completing these worksheets, see Appendix A, "Preparing the Communication Worksheet" on page 115.

- Applications Worksheet

For instructions on completing this worksheet, see Appendix B, "Preparing the Applications Worksheet" on page 127.



## IBM 5394 Remote Work Station Setup Worksheet

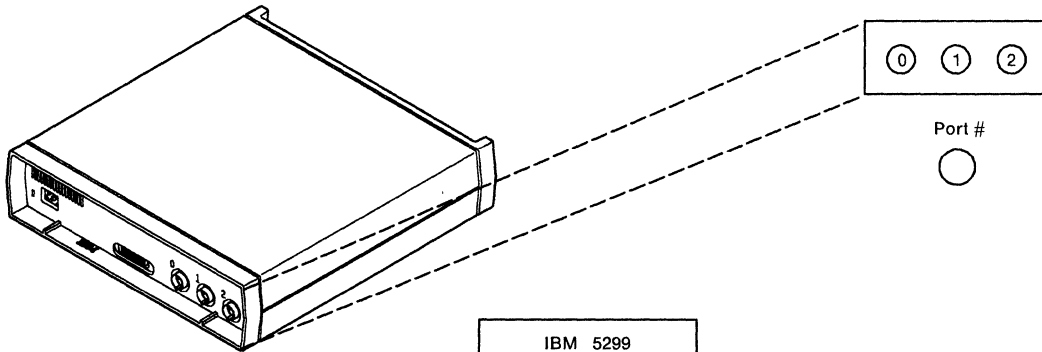

IBM 5299						
0	1	2	3	4	5	6

Name		Socket 1
Device Type		
Location		
Work Station Address		
Unit Address		
Keyboard Code		
Telephone		Socket 2

Socket 1	Name	
	Device Type	
	Location	
	Work Station Address	
	Unit Address	
	Keyboard Code	
Socket 2	Telephone	

Name		Socket 1
Device Type		
Location		
Work Station Address		
Unit Address		
Keyboard Code		
Telephone		Socket 2

Socket 1	Name	
	Device Type	
	Location	
	Work Station Address	
	Unit Address	
	Keyboard Code	
Socket 2	Telephone	

Name		Socket 1
Device Type		
Location		
Work Station Address		
Unit Address		
Keyboard Code		
Telephone		Socket 2

Socket 1	Name	
	Device Type	
	Location	
	Work Station Address	
	Unit Address	
	Keyboard Code	
Socket 2	Telephone	

Name		Socket 1
Device Type		
Location		
Work Station Address		
Unit Address		
Keyboard Code		
Telephone		Socket 2

**Note:** Each cable connected to an IBM 5394 Control Unit port should have a tag with a number from 0 through 2. Each port used should have a cable. Connect each cable to the port indicated on its tag.



**IBM 5394 SDLC Communication Worksheet**

<b>A</b> Host system type and location	_____
<b>B</b> IBM 5394 model number	_____
<b>C</b> IBM 5394 location	_____
<b>D</b> IBM 5394 SDLC station address	_____
<b>E</b> Modem or DCE model number	_____
<b>F</b> Modem configuration information (Fill in the blank or circle the appropriate choice in each column):	
<b>F1</b> Modem or DCE type	_____
<b>F2</b> Half-duplex	Duplex
<b>F3</b> Multipoint(or fan-in/out modem)	Point-to-point
<b>F4</b> NRZI	NRZ
<b>F5</b> DTR	CDSTL
<b>F6</b> Leading pad not required	Leading pad
<b>F7</b> Local loopback not supported	Local loopback
<b>G</b> V.25 bis auto-dial option information (complete <b>G1</b> and <b>G2</b> if you selected auto-dial switched in <b>F1</b> .)	
<b>G1</b> V.25 bis timeout (in seconds)	_____
<b>G2</b> V.25 bis call information saved to diskette	Call information not saved

**Send the completed worksheet to the remote location to ensure correct installation of the IBM 5394 Remote Control Unit.**



**IBM 5394 X.25 Communication Worksheet**

- A** Host system type and location \_\_\_\_\_
- B** IBM 5394 model number \_\_\_\_\_
- C** IBM 5394 location \_\_\_\_\_
- D** IBM 5394 station address \_\_\_\_\_
- E** X.25 subscription data:
  - E1** Packet level sequence numbering (Modulo 8 or Modulo 128)
  - E2** Packet window size \_\_\_\_\_
  - E3** Link window size \_\_\_\_\_
- F** X.25 configuration data:
  - F1** Packet size (64 bytes, 128 bytes, 256 bytes, or 512 bytes)
  - F2** Circuit type \_\_\_\_\_
  - F3** Flow control negotiation allowed (yes or no)
  - F4** Manual options allowed (yes or no)
  - F5** Local loopback supported (yes or no)
- G** X.25 software data:
  - G1** Reverse charging accepted (yes or no)
  - G2** Logical link control (PSH, QLLC, or ELLC)
  - G3** Special network attachment (yes or no)
  - G4** Link initialization control (network only or network and control unit)
  - G5** Network subscription (1984 or 1980)
  - G6** Diagnostics code (1984 SNA, 1984 ISO, or 1980 SNA)
- H** Retry parameters:
  - H1** Number of retries \_\_\_\_\_
  - H2** Seconds between retries \_\_\_\_\_

**Send the completed worksheet to the remote site to ensure correct installation of the IBM 5394 Remote Control Unit.**





**IBM 5394 X.21 Switched Communication Worksheet**

- A** Host system type and location \_\_\_\_\_
- B** IBM 5394 model number \_\_\_\_\_
- C** IBM 5394 location \_\_\_\_\_
- D** IBM 5394 SDLC station address \_\_\_\_\_
- E** X.21 network ID# \_\_\_\_\_
- F** Short Hold mode (SHM) retries:
  - F1** Number of retries \_\_\_\_\_
  - F2** Delay between retries \_\_\_\_\_
  - F3** Direct (yes or no) call support
- G** Retry of optional call progress signals:  
\_\_\_\_\_, \_\_\_\_\_, \_\_\_\_\_, \_\_\_\_\_  
\_\_\_\_\_, \_\_\_\_\_, \_\_\_\_\_, \_\_\_\_\_

**Send the completed worksheet to the remote site to ensure correct installation of the IBM 5394 Remote Control Unit.**



**APPLICATIONS WORKSHEET--OPERATOR'S INFORMATION**

**A** Setup instructions for the following applications:

\_\_\_\_\_  
\_\_\_\_\_  
\_\_\_\_\_  
\_\_\_\_\_

**B** Host Contact \_\_\_\_\_

**C** Telephone \_\_\_\_\_

1. Press the System Request key sequence. See Appendix F, Key Sequences in the *IBM 5394 Remote Control Unit User's Guide* for the correct sequence for your keyboard.
2. Enter the following as one line:

**D**

--	--	--	--	--	--	--	--	--	--	--	--	--	--	--	--	--	--	--	--

--	--	--	--	--	--	--	--	--	--	--	--	--	--	--	--	--	--	--	--

--	--	--	--	--	--	--	--	--	--	--	--	--	--	--	--	--	--	--	--

--	--	--	--	--	--	--	--	--	--	--	--	--	--	--	--	--	--	--	--

3. Press Enter.



## Appendix D. Determining Your Communication Mode

To determine which communication mode your system uses, do the following:

- Step 1** Make sure the control unit is set to off (O). Make sure the system diskette is in the diskette drive.
- Step 2** Set the control unit Test switch to On.
- Step 3** Set the control unit power switch to on (I). Wait for the Ready and Work Station Active indicators to come on.
- Step 4** Press the Test Request key sequence to display the configuration screen. See Appendix F, "Key Sequences" on page 197 for the correct sequence for your keyboard.
- Step 5** To determine your communication mode, look at Field AA near the bottom of the configuration screen. Your screen may not match this illustration exactly.

```
AA-> ?   BB-> 0
1-> 00    2-> 01   3-> 0 0 0 0 0 0 0 0   8-> 3C 0
P-> _ _
```

- If a 0 appears in Field AA, your communication mode is **SDLC**. Go to step 6.
- If a 1 appears in Field AA, your communication mode is **X.25**.
- If a 2 appears in Field AA, your communication mode is **X.21 switched**.

- Step 6** If your IBM 5394 is in **SDLC communication mode**, look at the leftmost position of Field 3 on the configuration screen to determine your line type.

```
AA-> 0   BB-> 0
1-> 00    2-> 01   3-> ? 0 0 0 0 0 0 0 0   8-> 3C A
P-> _ _
```

If a 0 appears in this position, the communication line is non-switched.

If a 1 or 2 appears in this position, the communication line is switched.



## Appendix E. System Reference Codes

This appendix lists system reference codes (SRCs) that may appear on the screen during operation. An SRC can be 4 or 6 alphanumeric characters. These characters blink and are located in the upper left corner or the lower left corner of the display screen.

### Determining Code Range

The following table defines specific ranges for SRCs. Refer to the leftmost column to determine the range of codes that contains your SRC. For example, SRC 0026 is contained within the 0000 through 003F range. Notice that each range of codes is in ascending sequence.

Read the second and third columns, and respond to the instructions in the rightmost column.

System Reference Code (SRC)	Reason for SRC	SRC Is Displayed on These Screens	Response to SRC (See Note 1)
0000 through 003F	An operator error occurred during an entry operation.	Where the error originated.	Go to "Operator Entry System Reference Codes" on page 156. Locate the SRC and follow the instructions.
0040 through 005F	An error occurred on the communication network during the time the IBM 5394 was communicating with the host system.	All active display stations.	Go to "Communication Network System Reference Codes" on page 161. Locate the SRC and follow the instructions.
0060 through 006F	An error occurred that is related to either the ideographic support function or the bidirectional support function.	Where the error originated.	Go to "Ideographic Support System Reference Codes" on page 166 or "Bidirectional Support System Reference Codes" on page 167. Locate the SRC and follow the instructions.
0070 through 007F	An operator error occurred while using the text processing function.	Where the error originated.	Go to "Text Entry Assist System Reference Codes" on page 168. Locate the SRC and follow the instructions.
0080 through 008F	An error occurred during the IBM 5394 setup procedure.	Only on the display station being used for the setup procedure.	Go to "Customer Setup System Reference Codes" on page 169. Locate the SRC and follow the instructions.
0090 through 009F	A display station operator caused an error that involves the host system.	Where the error originated.	Go to "Host Support System Reference Codes" on page 170. Locate the SRC and follow the instructions.
10000 through 10FFFF	A display station operator attempted to enter an incorrect or invalid X.25 command or parameter from the keyboard.	Where the error originated.	Go to "X.25 Operator System Reference Codes" on page 171. Locate the SRC and follow the instructions.



<b>System Reference Code (SRC)</b>	<b>Reason for SRC</b>	<b>SRC Is Displayed on These Screens</b>	<b>Response to SRC (See Note 1)</b>
<b>110000 through 1FFFFF</b>	An error was detected by the DTE or DCE on an X.25 network.	All active display stations.	Go to "X.25 Communication System Reference Codes" on page 175. Locate the SRC and follow the instructions.
<b>200000 through 20FFFF</b>	A display station operator attempted to enter an incorrect or invalid X.21 command or parameter from the keyboard.	Where the error originated.	Go to "X.21 Switched Operator System Reference Codes" on page 187. Locate the SRC and follow the instructions.
<b>210000 through 2FFFFF</b>	An error was detected by the DTE or DCE on an X.21 switched network.	All active display stations.	Go to "X.21 Switched Communication System Reference Codes" on page 188. Locate the SRC and follow the instructions.
<b>300000 through 30FFFF</b>	A display station operator attempted to enter an incorrect or invalid V.25 bis command or parameter from the keyboard.	Where the error originated.	Go to "V.25 bis Operator System Reference Codes" on page 192. Locate the SRC and follow the instructions.
<b>310000 through 31FFFF</b>	The DCE sent a call indication in response to an outgoing call request.	Where the error originated.	Go to "V.25 bis Call Indication System Reference Codes" on page 193. Locate the SRC and follow the instructions.
<b>320000 through 32FFFF</b>	An error occurred during call establishment that led to termination of the call.	Where the error originated.	Go to "V.25 bis Circuit-Terminating System Reference Codes" on page 193. Locate the SRC and follow the instructions.
<b>500000 through 50FFFF</b>	A diskette drive or diskette error was detected.	All active display stations. See note 2.	Go to "Diskette Drive and Diskette System Reference Codes" on page 194. Locate the SRC and follow the instructions.
<b>510000 through 51FFFF</b>	An error occurred while installing a microcode change.	All active display stations.	Go to "Microcode Change System Reference Codes" on page 195. Locate the SRC and follow the instructions.
<b>520000 through 52FFFF</b>	An error occurred during a copy-to-printer operation.	Where the error originated.	Go to "Copy-to-Printer and Local Copy System Reference Codes" on page 195. Locate the SRC and follow the instructions.
<b>530000 through 5FFFFF</b>	Reserved		
<b>600000 through 6FFFFF</b>	These SRCs are displayed only during IBM 5394 testing procedures.	Only on the display station being used for the testing procedures.	SRC does not display when the Test switch is in the Off position. See "Running the EIA 232D or X.21 Switched Extended Test Routine" on page 99 for information about these SRCs.

<b>System Reference Code (SRC)</b>	<b>Reason for SRC</b>	<b>SRC Is Displayed on These Screens</b>	<b>Response to SRC (See Note 1)</b>
<b>D10000 through DFFFFF</b>	An error was detected during the IBM 5394 power-on sequence.	All active display stations. See Note 2.	Go to "Power-On Sequence System Reference Codes" on page 196. Locate the SRC and follow the instructions.
<b>E00000 through EFFFFF</b>	A hardware error occurred in the IBM 5394 during operation.	All active display stations. See Note 2.	Record the SRC. Set the control unit power switch to off (O) and then to on (I). If the error occurs again, contact your customer service representative and report the SRC.
<b>F00000 through FFFFFF</b>	A microcode error occurred in the IBM 5394 during operation.	All active display stations. See Note 2.	Record the SRC. Contact the customer service representative and report the SRC.

**Notes:**

1. The SRC may not appear until the Enter key is pressed.
2. Certain types of errors can prevent the SRC from appearing on all active display stations.

## Operator Entry System Reference Codes

If an entry error occurs, further input is inhibited. A blinking cursor indicates the location of the error and a four-digit SRC between 0000 and 003F is displayed. The host system program determines the location of the displayed SRC, but it is usually displayed on the last line of the screen.

While using some applications, you can press the Help key to display the message that describes the error. Then press the Error Reset key to recover from the error. The cursor remains at its current position unless otherwise noted.

The SRCs, their meanings, and recovery procedures are as follows:

SRC	Meaning and Recovery Procedure
0000	<p>Help Key Not Allowed</p> <p>You pressed the Help key; however, either no SRC was displayed or the application program does not support the Help key.</p> <p>To recover, press the Error Reset key. Continue entering information or refer to the meaning for the previously displayed SRC and do the recovery procedure.</p>
0001	<p>Keyboard Overrun</p> <p>The IBM 5394 has not kept up with the rate you were entering information. The last character you entered was not recognized.</p> <p>To recover, press the Error Reset key and continue entering information.</p>
0002	<p>Invalid Scan Code</p> <p>The IBM 5394 received an invalid key code from the display station. Either the keyboard code is incorrect for the keyboard at your display station, or an error occurred in translating the keystroke.</p> <p>To recover, press the Error Reset key and try to continue entering the data. If the error occurs again, check the configuration for your display station. If the configuration is correct, contact the display station service representative and report the problem.</p>
0003	<p>Invalid Command/PF Key</p> <p>You pressed either a command key sequence, a PF key that is not supported or not valid for the current field, or an invalid Alt key sequence.</p> <p>To recover, press the Error Reset key and continue, using the correct keys.</p>
0004	<p>Data Not Allowed in This Field</p> <p>You tried to enter data from the keyboard into a field where only an entry from a magnetic stripe reader or a selector light pen is allowed.</p> <p>To recover, press the Error Reset key. Move the cursor to a field where data from the keyboard can be entered.</p>
0005	<p>Cursor in Protected Area of Display</p> <p>You have tried to enter data; however, the cursor is not in an input field on the display. Data cannot be entered in a protected area of the display.</p> <p>To recover, press the Error Reset key and move the cursor to a valid input field.</p>

SRC	Meaning and Recovery Procedure
0006	<p>Key Following Sys Req Key Not Valid</p> <p>You pressed the Sys Req/Attn key while establishing an X.25 circuit, or you pressed an invalid key after pressing the Sys Req/Attn key and before pressing the Enter/Rec Adv key or the Error Reset key.</p> <p>To recover, press the Error Reset key, wait for the logon screen to appear, and use a valid key sequence.</p>
0007	<p>Mandatory Enter Field - Must Enter Data</p> <p>There is at least one mandatory entry field on the screen that you must enter data into before the screen can be changed or processed. (The cursor goes to the first character position of the first unentered mandatory entry field.)</p> <p>To recover, press the Error Reset key and enter the required data.</p>
0008	<p>This Field Must Have Alphabetic Characters</p> <p>You tried to enter nonalphabetic characters into a mandatory alphabetic field. Valid characters are A through Z, blank, comma, period, hyphen, apostrophe, and Dup. The Dup key may be used to duplicate these characters in the field.</p> <p>To recover, press the Error Reset key and continue, using valid characters.</p>
0009	<p>This Field Must Have Numeric Characters</p> <p>You tried to enter nonnumeric characters into a mandatory numeric field. Valid characters are 0 through 9, blank, comma, period, plus, minus, and Dup. The Dup key may be used to duplicate these characters in the field.</p> <p>To recover, press the Error Reset key and continue, using valid characters.</p>
0010	<p>Only Characters 0 Through 9 Permitted</p> <p>The key pressed is not valid for a signed numeric field. Valid characters are 0 through 9 and Dup.</p> <p>To recover, press the Error Reset key and continue, using valid characters.</p>
0011	<p>Key For Sign Position of Field Not Valid</p> <p>You tried to enter data into the last position of a signed numeric field.</p> <p>To recover, press the Error Reset key. Make sure that the data is correct, and exit the field by using the Field -, Field +, or Field Exit key.</p>
0012	<p>Insert Mode - No Room to Insert Data</p> <p>There is no room to insert data into this field. Either there is no more room in the field, or the cursor is in the last position of the field.</p> <p>Do not use Insert mode to change data or to enter the last character into this field.</p> <p>To recover, press the Error Reset key. Correct the field, if necessary, and continue.</p>
0013	<p>Insert Mode - Only Data Keys Permitted</p> <p>You tried to exit a field while the display station was still in Insert mode.</p> <p>To recover, press the Error Reset key and exit the field normally.</p>
0014	<p>Mandatory Fill Field - Must Fill to Exit</p> <p>You pressed a function key that would move the cursor out of this field; however, the requirements of this mandatory-fill field were not met. A mandatory-fill field must be completely filled or left blank.</p> <p>To recover, press the Error Reset key. Enter data to fill the entire field, or move the cursor to the start of the field, and use the Field -, Field +, or Field Exit key to blank all of the field.</p>

SRC	Meaning and Recovery Procedure
0015	<p>Modulo 10 or 11 Check Digit Error</p> <p>You entered data into a self-check field, and the number you entered and the check digit do not compare.</p> <p>To recover, press the Error Reset key. Make sure that you have correctly entered the number and check digit. If you entered them correctly, make sure that the number is valid for a self-check field. If the numbers you are using are valid but this error still occurs, contact the display station service representative and report the problem.</p>
0016	<p>F- Key Not Valid in This Field</p> <p>You pressed the Field - key when the cursor was not in a numeric-only, digits-only, or signed numeric field.</p> <p>To recover, press the Error Reset key. Continue to enter data or press the Field Exit key to exit the field.</p>
0017	<p>Mandatory Fill Field - Key Pressed is Not Valid</p> <p>You pressed the Field -, Field +, or Field Exit key; however, the requirements for this mandatory-fill field were not met. A mandatory-fill field must be completely filled unless you exit it from the first position of the field.</p> <p>To recover, press the Error Reset key. Enter data to the end of the field or move the cursor to the start of the field and use the Field -, Field +, or Field Exit key to blank all of the field.</p>
0018	<p>Key Used to Exit This Field Not Valid</p> <p>The cursor is in a right adjust or field exit required field, and you pressed a data key.</p> <p>Use the Field Exit key to exit this field.</p> <p>To recover, press the Error Reset key. Press a Field Exit key to exit this field.</p>
0019	<p>Dup or Field Mark Key Not Permitted in This Field</p> <p>You pressed the Dup or Field Mark key; however, the key is not permitted in this field.</p> <p>To recover, press the Error Reset key. Continue without using the Dup or Field Mark key in this field.</p>
0020	<p>Function Key Not Valid for Right Adjust Field</p> <p>You pressed a function key that is not permitted in this field. Press the Field Exit, F+, or F-key to exit this field before pressing one of the following function keys:</p> <ul style="list-style-type: none"> <li>• Test Req</li> <li>• Clear</li> <li>• Enter/Rec Adv</li> <li>• Print</li> <li>• Help</li> <li>• Roll</li> <li>• Home (when the cursor is in the home position)</li> <li>• PF/Cmd1-24</li> <li>• Sys Req</li> <li>• Rec Backspace.</li> </ul> <p>To recover, press the Error Reset key. The cursor is in the same position it was when you pressed the invalid key. Continue by pressing the Field -, Field +, or Field Exit key.</p>
0021	<p>Mandatory Enter Field - Must Enter Data</p> <p>The cursor is positioned in a mandatory entry field. You must enter data into a mandatory entry field before you can exit the field by pressing the Field -, Field +, or Field Exit key. You can exit from any position if no data is entered.</p> <p>To recover, press the Error Reset key and enter the required data.</p>

<b>SRC</b>	<b>Meaning and Recovery Procedure</b>
<b>0022</b>	<p>Status of Field Not Known</p> <p>A system error occurred. The status of the current field is not known. This error can occur during an insert or delete operation.</p> <p>To recover, press the Error Reset key. Check the display screen to determine if the insert or delete function was completed properly. If not completed properly, correct the field.</p>
<b>0023</b>	<p>Hex Mode - Entry Not Valid</p> <p>You are in hexadecimal mode but the first key pressed was not a character 4 through 9 or A through F, or the second key pressed was not a character 0 through 9 or A through F.</p> <p>This error also occurs when a hexadecimal code is used in a numeric-only, signed numeric, digits-only, alpha-only, or I/O field.</p> <p>To recover, press the Error Reset key. Continue by pressing the correct keys.</p>
<b>0024</b>	<p>Decimal Field - Entry Not Valid</p> <p>You pressed a key that is not valid. Only characters 0 through 9 and the Dup key (if specified in the field format word) are allowed in this field.</p> <p>To recover, press the Error Reset key and continue by entering digits in this field.</p>
<b>0026</b>	<p>F- Key Entry Not Valid</p> <p>You pressed the Field - key to exit a numeric-only field but the last position of the field was not a character 0 through 9.</p> <p>To recover, press the Error Reset key. Correct the last position of this field or exit the field by using a key other than the Field - key; for example, the Field + or Field Exit key.</p>
<b>0027</b>	<p>Key Not Defined - Key Cannot Be Used</p> <p>You pressed a key that is either blank or not defined for your display station.</p> <p>To recover, press the Error Reset key and continue, using valid keys.</p>
<b>0029</b>	<p>Diacritic Character Not Valid</p> <p>The second key pressed during a diacritic key function did not produce a valid diacritic character.</p> <p>To recover, press the Error Reset key and enter a valid combination.</p>
<b>0031</b>	<p>Data Buffer Overflow</p> <p>The data received from the magnetic stripe reader card was longer than the maximum allowed.</p> <p>To recover, press the Error Reset key and use another magnetic stripe reader card.</p>
<b>0032</b>	<p>MSR Data Error</p> <p>The data from the magnetic stripe reader was not received correctly.</p> <p>To recover, press the Error Reset key and pass the card through the magnetic stripe reader again. If the error is still present after several attempts, contact the display station service representative and report the problem.</p>
<b>0033</b>	<p>MSR Secure Data Read Not Authorized</p> <p>The magnetic stripe reader data received was secured data (for example, an operator ID card), and this field was not specified for secured data.</p> <p>To recover, press the Error Reset key and continue using a correct magnetic stripe reader card.</p>

SRC	Meaning and Recovery Procedure
0034	<p>MSR Data Exceeds Length of Field</p> <p>The magnetic stripe reader data received will not fit into the active input field.</p> <p>To recover, press the Error Reset key. Pass another card through the magnetic stripe reader. If the error is still present, contact the host system operator and report a possible programming error.</p>
0035	<p>MSR Error</p> <p>The card to be read was incorrectly inserted into the magnetic stripe reader, was incorrectly made, or is damaged.</p> <p>To recover, press the Error Reset key. Put the card to be read through the magnetic stripe reader again. If the error is still present after several attempts, try other magnetic stripe reader cards or the test magnetic stripe reader card to make sure that the problem is not caused by a defective card. If the error is still present, contact the display station service representative and report the problem.</p>
0036	<p>Cursor Select Not Allowed in Field Exit Required State</p> <p>You pressed the Cursor Select key while in field exit required state.</p> <p>To recover, press the Error Reset key. Complete the current field or use the Field Exit or Field Backspace key to position the cursor.</p>
0037	<p>Cursor Select Attempted in Non-Selectable Field</p> <p>You pressed the Cursor Select key in a nonselectable field.</p> <p>To recover, press the Error Reset key. Then position the cursor to a field where the cursor select function is valid. For more information, refer to your display station operator's guide.</p>
0038	<p>Light Pen and MSR Use Not Allowed</p> <p>You attempted to use the selector light pen or magnetic stripe reader while using text processing. These functions are not valid for text processing.</p> <p>To recover, press the Error Reset key.</p>

## Communication Network System Reference Codes

If a communication error occurs, a four-digit code between 0040 and 0054 appears on the screen. Find your SRC in this table and follow the recovery procedures given.

SRC	Meaning and Recovery Procedure
0040	<p>Modem or DCE Not Ready</p> <p>Data Set Ready (DSR) Line Inactive (Model 01); DCE Not Ready (Model 02).</p> <p>This error indicates that the modem or DCE was not ready during required intervals of normal operation. The operating state of the modem or DCE is checked at different times, depending on the specific link-level protocol in use.</p> <p>This SRC can be caused by the configuration being incorrect, but if you are sure that the configuration is correct or has not changed, go to step 2.</p> <ol style="list-style-type: none"> <li>1. To verify the configuration, do the following:           <ol style="list-style-type: none"> <li>a. Go to "Beginning Configuration" on page 32 and do steps 1 through 6 to display the configuration screen.</li> <li>b. Look at Subfield 1 (the leftmost position) of Field 3. This subfield selects the communication line type. Valid entries are 0 = nonswitched line, 1 = manual-dial switched line, and 2 = auto-dial switched line.</li> <li>c. If the setting in Field 3, Subfield 1 is correct for your system, go to step 2. If the setting is not correct, follow the instructions in "Completing Configuration for SDLC Communication" on page 40 to correct the setting, and retry the job.</li> </ol> </li> <li>2. See "Running the EIA 232D or X.21 Switched Extended Test Routine" on page 99 or "Running the V.35 Extended Test Routine" on page 107 and run the extended test routine. If the extended test routine directs you to report this error, report to one of the following:           <ul style="list-style-type: none"> <li>• The modem service representative that the "data set ready" line from the modem is inactive when it should be active.</li> <li>• The network service representative that the network is out of service or that no signal is being received from the DCE.</li> </ul> </li> </ol>
0041	<p>Idle Condition Detected (X.25 only)</p> <p>This error indicates that the "receive" line was idle for 15 or more contiguous bit-times.</p> <p>See "Running the EIA 232D or X.21 Switched Extended Test Routine" on page 99 or "Running the V.35 Extended Test Routine" on page 107 and run the extended test routine. If the extended test routine directs you to report this error, contact the network service representative and report that the "indicate" lines or the "received line signal detector" line is inactive when it should be active.</p>
0042	<p>Receive Clock Failure</p> <p>This error indicates that the receive clock signal became inactive during data transfer.</p> <p>See "Running the EIA 232D or X.21 Switched Extended Test Routine" on page 99 or "Running the V.35 Extended Test Routine" on page 107 and run the extended test routine. If the extended test routine directs you to report this error, contact the modem or DCE service representative and report that "receive clock" signals are not being received from the modem or DCE.</p>



SRC	Meaning and Recovery Procedure
0043	<p><b>DSR Remains Active (Model 01 on switched networks only)</b></p> <p>This error indicates that the control unit attempted to disconnect from the line, but the DSR line failed to become inactive. (This error is also posted when the modem or DCE is not operating in CDSTL mode and the DSR line becomes active before DTR.)</p> <p>This SRC can be caused by the configuration being incorrect, but if you are sure that the configuration is correct or has not been changed, go to step 2.</p> <ol style="list-style-type: none"> <li>1. To verify the configuration, do the following: <ol style="list-style-type: none"> <li>a. Go to "Beginning Configuration" on page 32 and do steps 1 through 6 to display the configuration screen.</li> <li>b. Look at Subfield 1 (the leftmost position) of Field 3. This subfield selects the communication line type. Valid entries are 0 = nonswitched line, 1 = manual-dial switched line, and 2 = auto-dial switched line.</li> <li>c. If the setting in Field 3, Subfield 1 is correct for your system, go to step 2 on page 162. If the setting is not correct, follow the instructions in "Completing Configuration for SDLC Communication" on page 40 to correct the setting, and retry the job.</li> </ol> </li> <li>2. See "Running the EIA 232D or X.21 Switched Extended Test Routine" on page 99 or "Running the V.35 Extended Test Routine" on page 107 and run the extended test routine. If the extended test routine directs you to report this error, contact the modem or DCE service representative and report that the "data set ready" line is active when it should be inactive.</li> </ol>
0044	<p><b>30-Second Timeout (switched line only)</b></p> <p>This error indicates that no valid data has been received for 30 seconds. The DTR signal goes inactive to disconnect the line.</p> <p>If the IBM 5394 is attached to an X.25 network, call the customer service representative. If the IBM 5394 is attached to an X.21 switched network and you are using Model 02A or 02B, go to step 2.</p> <p>If you are not sure which communication mode your IBM 5394 uses, see Appendix D, "Determining Your Communication Mode" on page 151.</p> <p>This SRC can be caused by the configuration being incorrect, but if you are sure that the configuration is correct or has not been changed, go to step 2.</p> <ol style="list-style-type: none"> <li>1. To verify the configuration, do the following: <ol style="list-style-type: none"> <li>a. Go to "Beginning Configuration" on page 32 and do steps 1 through 6 to display the configuration screen.</li> <li>b. Look at Subfield 1 (the leftmost position) of Field 3. This subfield selects the communication line type. Valid entries are 0 = nonswitched line, 1 = manual-dial switched line, and 2 = auto-dial switched line.</li> <li>c. If the setting in Field 3, Subfield 1 is correct for your system, go to step 2 on page 162. If the setting is not correct, follow the instructions in "Completing Configuration for SDLC Communication" on page 40 to correct the setting, and retry the job.</li> </ol> </li> <li>2. See "Running the EIA 232D or X.21 Switched Extended Test Routine" on page 99 or "Running the V.35 Extended Test Routine" on page 107 and run the extended test routine. If the extended test routine directs you to report this error, contact the host system operator and report that communication is being lost due to a receive timeout but the control unit is operating correctly.</li> </ol>

SRC	Meaning and Recovery Procedure
0045	<p>DCE Will Not Activate (X.25 only)</p> <p>This error indicates that either a Disconnect mode (DM) or a DISCONNECT (DISC) command was received during the link setup sequence.</p> <p>To restart communication, see Chapter 6, "Communicating with Your Host System" on page 63.</p> <p>Retry the procedure. If this SRC occurs again, contact your network service representative and report the problem.</p>
0046	<p>Frame Reject Received (X.25 only)</p> <p>The control unit received an FRMR from the network, indicating that an error was detected in the last frame transmitted. The error log entry of this code includes three sense bytes, which preserve the contents of the FRMR I-field.</p> <p>To restart communication, see Chapter 6, "Communicating with Your Host System" on page 63.</p> <p>Retry the job. If this SRC occurs again, contact the customer service representative and report the problem.</p>
0047	<p>Unexpected Disconnect Mode (DM) or DISCONNECT (DISC) Command Received (X.25 only)</p> <p>This error indicates that either a Disconnect mode (DM) or a DISCONNECT (DISC) command was received while in information transfer state.</p> <p>To restart communication, see Chapter 6, "Communicating with Your Host System" on page 63.</p> <p>Retry the job. If this SRC occurs again, contact your network service representative and report the problem.</p>
0048	<p>Unexpected Unnumbered Acknowledgment (UA) Frame Received (X.25 only)</p> <p>This error is posted if the control unit receives a UA frame while in the information transfer state.</p> <p>To restart communication, see Chapter 6, "Communicating with Your Host System" on page 63.</p> <p>Retry the job. If this SRC occurs again, contact your network service representative and report the problem.</p>

SRC	Meaning and Recovery Procedure
0050	<p>Ready For Sending (RFS) Error (Model 01 only)</p> <p>This error is posted when either:</p> <ul style="list-style-type: none"> <li>• The RFS line is inactive for up to 30 seconds while the RTS line is active.</li> <li>• The RFS line is active when the RTS line is inactive (except during V.25 bis call establishment).</li> </ul> <p>If the IBM 5394 is attached to an X.25 network, go to step 2 below. If you are not sure which communication mode your IBM 5394 uses, see Appendix D, "Determining Your Communication Mode" on page 151.</p> <p>This SRC can be caused by the configuration being incorrect, but if you are sure that the configuration is correct or has not been changed, go to step 2.</p> <ol style="list-style-type: none"> <li>1. To verify the configuration, do the following: <ol style="list-style-type: none"> <li>a. Go to "Beginning Configuration" on page 32 and do steps 1 through 6 to display the configuration screen.</li> <li>b. Look at Subfield 2 (the second position) of Field 3. This subfield selects a half-duplex or duplex line. Valid entries are 0=half-duplex and 1=duplex.</li> <li>c. Look at Subfield 3 of Field 3. This subfield selects a multipoint or point-to-point line. Valid entries are 0=multipoint and 1=point-to-point.</li> <li>d. If the settings in these subfields are correct for your system and match your modem configuration, go to step 2 below. If the settings are not correct, follow the instructions in "Completing Configuration for SDLC Communication" on page 40 to correct the settings, and retry the job.</li> </ol> </li> <li>2. See "Running the EIA 232D or X.21 Switched Extended Test Routine" on page 99 or "Running the V.35 Extended Test Routine" on page 107 and run the extended test routine. If the extended test routine directs you to report this error, contact the modem or DCE service representative and report that the "ready for sending" signal received from the modem or DCE is not correctly responding to the "request to send" signal sent from the control unit.</li> </ol>
0051	<p>Transmit Clock Failure</p> <p>The transmit clock failed during a transmit operation.</p> <p>See "Running the EIA 232D or X.21 Switched Extended Test Routine" on page 99 or "Running the V.35 Extended Test Routine" on page 107 and run the extended test routine. If the extended test routine directs you to report this error, contact the modem or DCE service representative and report that the "transmit clock" signal is not being received from the modem or DCE.</p>
0052	<p>Transmit Hardware Error</p> <p>The link adapter hardware failed to complete a transmit operation within 30 seconds, but no transmit clock or other DCE signal failure was detected.</p> <p>Contact the customer service representative and report the problem.</p>
0053	<p>Expiration of Retry Count (X.25 only)</p> <p>No acknowledgment of a transmission was received within allowed timeout. (Timeout retry count (N2) and retry interval (T1) are specified in CSU Field 7.)</p> <p>See "Running the EIA 232D or X.21 Switched Extended Test Routine" on page 99 or "Running the V.35 Extended Test Routine" on page 107 and run the extended test routine. If the extended test routine directs you to report this error, contact the network service representative and report that no acknowledgment of a transmission was received before the T1 timer expired after retries were exhausted.</p>

<b>SRC</b>	<b>Meaning and Recovery Procedure</b>
<b>0054</b>	<p data-bbox="440 237 643 264">Frame Reject Sent</p> <p data-bbox="440 281 1414 363">The control unit has sent a link-level FRMR response to the host system after receiving an invalid SDLC or LAPB command. Sense bytes S1, S2, and S3 preserve the contents of the FRMR I-field.</p> <p data-bbox="440 384 1382 438">To restart communication, see Chapter 6, "Communicating with Your Host System" on page 63.</p> <p data-bbox="440 457 1463 512">Retry the job. If this SRC occurs again, contact the host system operator and report a possible programming error.</p>

## Ideographic Support System Reference Codes

If an ideographic error occurs, a four-digit code between 0060 and 0069 appears on the screen. Find the SRC in this table and follow the recovery procedures given.

To recover from these errors, press the Error Reset key.

<b>SRC</b>	<b>Meaning and Recovery Procedure</b>
<b>0060</b>	<b>Alphanumeric Data Not Allowed</b> You attempted to enter alphanumeric data into a field that only accepts double-byte data characters.
<b>0061</b>	<b>Ideographic Data Not Translated</b> You attempted to enter a double-byte character into a field that only accepts alphanumeric data.
<b>0062</b>	<b>Data Type Change Not Valid</b> You attempted to change the data type, but the cursor is not in an open field or in the first position of an ideographic either field.
<b>0063</b>	<b>Ideographic Number Not Valid</b> You entered an ideographic character that is not valid while operating in Alternate Entry mode.
<b>0064</b>	<b>Key Not Defined</b> You pressed a key that is not valid for the current keyboard mode.
<b>0065</b>	<b>Reserved for Shift Characters</b> The cursor is positioned in a column reserved for shift-out or shift-in characters.
<b>0066</b>	<b>Repeat Key Not Valid</b> The cursor is positioned under a shift character or attribute character, or at the first valid entry character position of an input field. Only data characters can be repeated at these positions.
<b>0067</b>	<b>Extension Character RAM Full</b> The display station extension character RAM is full. Any additional extension characters display as a special default character.
<b>0068</b>	<b>Output Data Stream for Extension Characters Screen Not Valid</b> The output data stream to the control unit is not valid for extension characters. Any additional extension characters display as a special default character.
<b>0069</b>	<b>Outbound Extension Characters Not Valid</b> The output data stream to the control unit contains invalid or undefined extension characters. Any additional extension characters display as a special default character.

## Bidirectional Support System Reference Codes

If an error occurs relating to the bidirectional support function, a four-digit code between 0060 and 0069 appears on the screen. Find the SRC in this table and follow the recovery procedures given.

<b>SRC</b>	<b>Meaning and Recovery Procedure</b>
<b>0060</b>	Key Not Valid Within an Imbedded Segment The cursor is within an imbedded segment or on an end reverse control character. To recover, press the Error Reset key.
<b>0061</b>	Key Not Valid Outside an Imbedded Segment The cursor is outside an imbedded segment or on a begin reverse control character. To recover, press the Error Reset key.
<b>0069</b>	Unable to Insert Terminating Character The Automatic Shape Determination process cannot insert a terminating character (tail). To recover, press the Error Reset key.

## Text Entry Assist System Reference Codes

If you are using DisplayWrite software and an SRC between 0070 and 0078 appears on the screen, find the SRC in this table. Then, follow the recovery procedures given.

**Note:** These errors usually result in text messages similar to the ones provided here. The SRC is displayed only when the Help key is pressed.

SRC	Meaning and Recovery Procedure
0070	<p>Word Wrap/Carrier Return Error</p> <p>An error occurred during the word spill function or the carrier return function.</p> <p>To recover, press the Error Reset key. For more information, press the Help key.</p>
0071	<p>Command Conflict</p> <p>You attempted a start copy, move, or delete text operation while one of the previous operations was already in progress.</p> <p>To recover, press the Error Reset key. Try the operation again when the operation in progress is complete.</p>
0072	<p>Key Not Valid for Cursor Position</p> <p>The key pressed is not valid when the cursor is in the current position.</p> <p>To recover, press the Error Reset key. Move the cursor to the correct position and try again.</p>
0073	<p>Invalid Attempt to Delete</p> <p>You attempted to delete or replace an instruction or format change when the general prompt function was not active.</p> <p>To recover, press the Error Reset key. Press the general prompt command key to delete or replace instruction and format change characters. For more information, press the Help key.</p>
0074	<p>Invalid Entry During General Prompt</p> <p>You pressed a key that is not valid when using the general prompt function.</p> <p>To recover, press the Error Reset key.</p>
0075	<p>Character Not Found</p> <p>The find function failed to find the keyed characters.</p> <p>To recover, press the Error Reset key. Try the operation again when the operation in progress is complete.</p>
0076	<p>Continuous Insert Mode Failed</p> <p>The insert function failed because the host system has not processed the text on the screen.</p> <p>To recover, press the Error Reset key. Wait until the host system processes the text on the screen and try again.</p>
0077	<p>Function Key Selection Not Valid</p> <p>You either pressed a function key that is not valid at this time, or tried to use a 3270 keyboard function while in Word Processing mode.</p> <p>To recover, press the Error Reset key.</p>
0078	<p>Required Scale Line Not Defined to Control Unit</p> <p>The required scale line is not defined for your display station.</p> <p>There is an error in the application program. No scale line is defined for this line.</p>

## Customer Setup System Reference Codes

If your SRC is between 0080 and 008F, an error occurred during customer setup (CSU). Find the SRC in this table and follow the recovery procedures given.

SRC	Description
0081	<p>Too Many Work Stations</p> <p>More than the maximum number of work stations are attached to the control unit. (An E should appear on the display for every extra work station attached.)</p> <p>To recover, contact your planner to find out which work stations are extra and disconnect them.</p>
0083	<p>Keyboard Code Not Valid</p> <p>You tried to enter a keyboard code for a printer or at a location where no display station exists. (You can enter keyboard codes only beside Ds on the display.)</p> <p>To recover, make sure you have the correct address and port number of the display station and enter the keyboard code again.</p>
0087	<p>Flow Control Entry Error (X.25 only)</p> <p>The values for subfield 3 and subfield 4 of Field 5 are not compatible. If subfield 4 is 0, subfield 3 must be 1.</p> <p>To recover, compare the settings in Field 5 with the information on your X.25 Communication Worksheet. If the settings for flow control negotiations and manual options match the information on your worksheet, contact your planner to determine the correct settings.</p>
008B	<p>Too Many Keyboard Codes</p> <p>More than the maximum number of different keyboard codes have been used. A maximum of four different keyboard codes can be selected (the master country and three others).</p> <p>To recover, contact your planner to determine which four keyboard codes to use.</p>
008D	<p>Printer Port and Station Address Invalid</p> <p>To recover, check Field P, and make sure that the printer port and the station address are either both numbers or both underscores. If you selected a printer for copy-to-printer operations, both subfields should be numbers. If not, both should be underscores.</p>



## Host Support System Reference Codes

If your SRC is between 0097 and 009F, required host support is not currently available. Find the SRC in this table and follow the recovery procedures given.

SRC	Meaning and Recovery Procedure
0097	<p>Test Request Function Not Supported</p> <p>A test request function is not supported by the host system. Contact the host system operator and determine why the function is not supported.</p>
0098	<p>Undefined Hardware Error</p> <p>The control unit entered an error handling routine, but did not detect an error.</p> <p>To recover, press the Error Reset key.</p>
0099	<p>Host Support Not Currently Available</p> <p>A key requiring host system action was pressed, but either the requested function is not supported or the work station is not in session with the host system.</p> <p>To recover, select the step that is appropriate for the current status of the display station(s) or printer(s).</p> <ol style="list-style-type: none"><li data-bbox="367 827 1365 877">1. If this error occurs during CSU or while you are establishing communication with the host system, press the Error Reset key and retry the operation.</li><li data-bbox="367 898 1357 982">2. If there is at least one display station with a logon screen displayed, contact the host system operator and determine if all display stations and printers attached to the control unit are online.</li></ol> <p>If all attached display stations and printers are online, report to the host system operator that a mismatch may exist between the actual control unit cluster configuration and the system configuration record.</p> <ol style="list-style-type: none"><li data-bbox="367 1100 1247 1129">3. If no display stations have a logon screen displayed, go to step 26 on page 88.</li><li data-bbox="367 1142 1328 1205">4. If there is only one display station attached to the control unit, contact the host system operator and have the display station brought online.</li></ol> <p>If the display station cannot be brought online, go to step 2 on page 78.</p>

## X.25 Operator System Reference Codes

If the IBM 5394 is in the X.25 communication mode and an error occurs during the keyboard entry of command, options, or parameters, a six-digit SRC between 100000 and 10FFFF is displayed.

SRC	Meaning and Recovery Procedure
100000	<p>A previous CALL command is in progress.</p> <p>Wait until the previous CALL command is complete, or an SRC other than 100000 is displayed.</p>
100100	<p>A virtual circuit has already been established.</p> <p>The IBM 5394 can only communicate over one virtual circuit at a time. Wait for the virtual circuit currently in use to be detached before you retry your CALL or OPEN command.</p>
100200	<p>An ANSWER command was entered for a permanent virtual circuit (PVC).</p> <p>Your system configuration may be incorrect. To verify the configuration, go to "Beginning Configuration" on page 32 and display the configuration screen. Make sure that the settings on this screen match the information on your worksheets. Pay particular attention to Field 5, Subfield 2 (page 45).</p> <p>If the settings match, press the Error Reset key and try the operation again. To restart communication, go to Chapter 6, "Communicating with Your Host System" on page 63.</p> <p>If still unsuccessful, call the host system operator.</p>
100300	<p>A CALL command was entered for a permanent virtual circuit (PVC).</p> <p>Your system configuration may be incorrect. To verify the configuration, go to "Beginning Configuration" on page 32 and display the configuration screen. Make sure that the settings on this screen match the information on your worksheets. Pay particular attention to Field 5, Subfield 2 (page 45).</p> <p>If the settings match, press the Error Reset key. To restart communication, go to Chapter 6, "Communicating with Your Host System" on page 63.</p> <p>If still unsuccessful, call the host system operator.</p>
100400	<p>The logical channel ID is invalid because it is not 3 characters long.</p> <p>Press the Error Reset key to display the keyboard-entered option. To restart communication, go to Chapter 6, "Communicating with Your Host System" on page 63.</p> <p>If still unsuccessful, call the host system operator.</p>
100500	<p>The logical channel ID option is invalid because it is not a hexadecimal value between 001 and FFF.</p> <p>Press the Error Reset key. To restart communication, go to Chapter 6, "Communicating with Your Host System" on page 63.</p> <p>If still unsuccessful, call the host system operator.</p>
100600	<p>The password option is invalid because it is longer than 8 characters.</p> <p>Press the Error Reset key. To restart communication, go to Chapter 6, "Communicating with Your Host System" on page 63.</p> <p>If still unsuccessful, call the host system operator.</p>
100700	<p>The host network address (TO network address) is invalid because it is greater than 15 decimal digits.</p> <p>Press the Error Reset key. To restart communication, go to Chapter 6, "Communicating with Your Host System" on page 63.</p> <p>If still unsuccessful, call the host system operator.</p>

SRC	Meaning and Recovery Procedure
100800	<p>Your network address (FROM network address) is invalid because it is greater than 15 decimal digits.</p> <p>Press the Error Reset key. To restart communication, go to Chapter 6, "Communicating with Your Host System" on page 63.</p> <p>If still unsuccessful, call the host system operator.</p>
100900	<p>The network address is invalid because it does not contain all numeric digits (0 through 9).</p> <p>Press the Error Reset key. To restart communication, go to Chapter 6, "Communicating with Your Host System" on page 63.</p> <p>If still unsuccessful, call the host system operator.</p>
100A00	<p>You attempted to enter manual options or flow control negotiations from the keyboard, and the IBM 5394 is not configured to allow the option.</p> <p>Your system configuration may be incorrect. To verify the configuration, go to "Beginning Configuration" on page 32 and display the configuration screen. Make sure that the settings on this screen match the information on your worksheets. Pay particular attention to Field 5, Subfields 3 and 4 (page 45).</p> <p>If the settings match, press the Error Reset key. To restart communication, go to Chapter 6, "Communicating with Your Host System" on page 63.</p> <p>If still unsuccessful, call the host system operator.</p>
100B00	<p>The facility option was entered but the characters are not hexadecimal (0 through 9 or A through F).</p> <p>Press the Error Reset key. To restart communication, go to Chapter 6, "Communicating with Your Host System" on page 63.</p> <p>If still unsuccessful, call the host system operator.</p>
100C00	<p>The packet window size option is invalid because it is less than 02.</p> <p>Press the Error Reset key. To restart communication, go to Chapter 6, "Communicating with Your Host System" on page 63.</p> <p>If still unsuccessful, call the host system operator.</p>
100D00	<p>The packet window size option is invalid because it is greater than 07 and Modulo 8 is specified.</p> <p>Press the Error Reset key. To restart communication, go to Chapter 6, "Communicating with Your Host System" on page 63.</p> <p>If still unsuccessful, call the host system operator.</p>
100E00	<p>The packet window size option is invalid because it is greater than 15 and Modulo 128 is specified.</p> <p>Press the Error Reset key. To restart communication, go to Chapter 6, "Communicating with Your Host System" on page 63.</p> <p>If still unsuccessful, call the host system operator.</p>
100F00	<p>The packet size is not equal to 064, 128, 256, or 512.</p> <p>Press the Error Reset key. To restart communication, go to Chapter 6, "Communicating with Your Host System" on page 63.</p> <p>If still unsuccessful, call the host system operator.</p>
101000	<p>The closed user group option does not contain two decimal digits.</p> <p>Press the Error Reset key. To restart communication, go to Chapter 6, "Communicating with Your Host System" on page 63.</p> <p>If still unsuccessful, call the host system operator.</p>

SRC	Meaning and Recovery Procedure
101100	<p>An invalid control character was entered.</p> <p>Press the Error Reset key. To restart communication, go to Chapter 6, "Communicating with Your Host System" on page 63.</p> <p>If still unsuccessful, call the host system operator.</p>
101200	<p>The host network address is missing for a CALL command.</p> <p>Press the Error Reset key. To restart communication, go to Chapter 6, "Communicating with Your Host System" on page 63.</p> <p>If still unsuccessful, call the host system operator.</p>
101300	<p>An A, O, C, or D was not entered as the first control character or an A, O, C, or D was previously entered.</p> <p>Press the Error Reset key. To restart communication, go to Chapter 6, "Communicating with Your Host System" on page 63.</p> <p>If still unsuccessful, call the host system operator.</p>
101400	<p>A network address was entered for a permanent virtual circuit (PVC).</p> <p>Your system configuration may be incorrect. To verify the configuration, go to "Beginning Configuration" on page 32 and display the configuration screen. Make sure that the settings on this screen match the information on your worksheets. Pay particular attention to Field 5, Subfield 2 (page 45).</p> <p>If the settings match, press the Error Reset key. To restart communication, go to Chapter 6, "Communicating with Your Host System" on page 63.</p> <p>If still unsuccessful, call the host system operator.</p>
101500	<p>The password option was entered for a permanent virtual circuit (PVC).</p> <p>Your system configuration may be incorrect. To verify the configuration, go to "Beginning Configuration" on page 32 and display the configuration screen. Make sure that the settings on this screen match the information on your worksheets. Pay particular attention to Field 5, Subfield 2 (page 45).</p> <p>If the settings match, press the Error Reset key. To restart communication, go to Chapter 6, "Communicating with Your Host System" on page 63.</p> <p>If still unsuccessful, call the host system operator.</p>
101600	<p>The password option is invalid because it is not all alphanumeric characters.</p> <p>Press the Error Reset key. To restart communication, go to Chapter 6, "Communicating with Your Host System" on page 63.</p> <p>If still unsuccessful, call the host system operator.</p>
101800	<p>The closed user group option was entered either for an ANSWER command or an OPEN command.</p> <p>Press the Error Reset key. To restart communication, go to Chapter 6, "Communicating with Your Host System" on page 63.</p> <p>If still unsuccessful, call the host system operator.</p>
101900	<p>The Q or the E option was selected with the ANSWER command.</p> <p>Press the Error Reset key. To restart communication, go to Chapter 6, "Communicating with Your Host System" on page 63.</p> <p>If still unsuccessful, call the host system operator.</p>

SRC	Meaning and Recovery Procedure
101A00	<p>An F (facility) control character or an R (reversed charging) was entered for an ANSWER command or a PVC.</p> <p>Your system configuration may be incorrect. To verify the configuration, go to "Beginning Configuration" on page 32 and display the configuration screen. Make sure that the settings on this screen match the information on your worksheets. Pay particular attention to Field 5, Subfield 2 (page 45).</p> <p>If the settings match, press the Error Reset key. To restart communication, go to Chapter 6, "Communicating with Your Host System" on page 63.</p> <p>If still unsuccessful, call the host system operator.</p>
101B00	<p>The value entered with the E option is invalid because it is not 3 characters long, or it is not a decimal value in the range of 100-999.</p> <p>Press the Error Reset key. To restart communication, go to Chapter 6, "Communicating with Your Host System" on page 63.</p> <p>If still unsuccessful, call the host system operator.</p>
101C00	<p>A Call command was entered for an answer-only SVC.</p> <p>Your system configuration may be incorrect. To verify the configuration, go to "Beginning Configuration" on page 32 and display the configuration screen. Make sure that the settings on this screen match the information on your worksheets. Pay particular attention to Field 5, Subfield 2 (page 45).</p> <p>If the settings match, press the Error Reset key. To restart communication, go to Chapter 6, "Communicating with Your Host System" on page 63.</p> <p>If still unsuccessful, call the host system operator.</p>
101D00	<p>An OPEN command was entered for an answer-only SVC.</p> <p>Your system configuration may be incorrect. To verify the configuration, go to "Beginning Configuration" on page 32 and display the configuration screen. Make sure that the settings on this screen match the information on your worksheets. Pay particular attention to Field 5, Subfield 2 (page 45).</p> <p>If the settings match, press the Error Reset key. To restart communication, go to Chapter 6, "Communicating with Your Host System" on page 63.</p> <p>If still unsuccessful, call the host system operator.</p>

## X.25 Communication System Reference Codes

If the IBM 5394 accepts the keyboard-entered options, but the network operation with the host system fails, a code that indicates the type of communication problem is displayed on the attached work stations.

To use these tables, locate the diagnostic field (ff) of the SRC in the appropriate column (SNA or ISO). If you are not sure whether your system uses SNA or ISO diagnostic codes, search both columns. SRCs are not duplicated in the two columns except where they identify the same error.

Some recovery procedures instruct you to retry the operation. To retry the operation, do the following:

1. Issue the DETACH command. (See "Ending Communication" on page 74.)
2. Follow the instructions on your Applications Worksheet to establish communication with the host system.

### 1100ff or 1180ff System Reference Codes

The IBM 5394 issued a Clear Request packet after detecting an error.

The cause of the error is contained in the diagnostic field (ff). The diagnostic codes that apply to the 1100ff and 1180ff SRCs follow.

If one of the following SRCs is displayed, contact your supervisor because you will have to restart the job. To restart communication, go to Chapter 6, "Communicating with Your Host System" on page 63.

SNA Diagnostic Codes (ff)	ISO Diagnostic Codes (ff)	Meaning and Recovery Procedure
14	14	Invalid packet type for state p1.  Retry the operation. You may be allowed temporary operation. However, you should report the error to the network service representative.
15	15	Invalid packet type for state p2.  Retry the operation. You may be allowed temporary operation. However, you should report the error to the network service representative.
17	17	Invalid packet type for state p4.  Retry the operation. You may be allowed temporary operation. However, you should report the error to the network service representative.
18	18	Invalid packet type for state p5.  Retry the operation. You may be allowed temporary operation. However, you should report the error to the network service representative.

SNA Diagnostic Codes (ff)	ISO Diagnostic Codes (ff)	Meaning and Recovery Procedure
31	31	Call Connected not received within 200 seconds. Report problem to host system operator.
32	32	Clear Confirmation not received within 200 seconds. Report problem to host system operator.
50		General ELLC/QLLC error. Report the problem to the host system operator.
51		Undefined ELLC C-field. Report the problem to the host system operator.
54		Undefined ELLC I-field. Report the problem to the host system operator.
55		I-field too long. Report the problem to the host system operator.
56		ELLC frame reject received. Report the problem to the host system operator.
57		ELLC header invalid. Report the problem to the host system operator.
59		ELLC timeout (LT1 x LN2) condition. Report the problem to the host system operator.
5A		ELLC receive sequence count (LNr) invalid. Report the problem to the host system operator.
5B		ELLC recovery rejected/terminated. Report the problem to the host system operator.
60		General PSH error. Host system or network problem. Report the problem to the host system operator.
61		PSH sequence error. Host system or network problem. Report the problem to the host system operator.

<b>SNA Diagnostic Codes (ff)</b>	<b>ISO Diagnostic Codes (ff)</b>	<b>Meaning and Recovery Procedure</b>
<b>A1</b>		Invalid M-bit packet sequence. Report the problem to the host system operator.
<b>A6</b>	<b>26</b>	Packet too short. Make sure that the packet size entered (in the configuration or manually entered) matches the network subscription.
<b>A7</b>	<b>27</b>	Packet too long. Make sure that the packet size entered (in the configuration or manually entered) matches the network subscription.
<b>AA</b>		Interrupt packet not supported. Report the problem to the host system operator.
<b>AB</b>	<b>01</b>	Invalid packet send sequence number (Ps). Report the error to the network service representative.
<b>AC</b>	<b>02</b>	Invalid packet receive sequence number (Pr). Report the error to the network service representative.
<b>AD</b>		Invalid D-bit received. Report the problem to the host system operator.
<b>D0</b>	<b>F4</b>	General resources error. Retry the operation. Other applications may operate normally. However, you should report the error to the host system operator.
<b>D2</b>	<b>F5</b>	PIU too long. Retry the operation. Other applications may operate normally. However, you should report the error to the host system operator.
<b>E0</b>	<b>69</b>	Invalid facility length. Report the error to the host system operator.
<b>E6</b>	<b>42</b>	Facility parameters not supported. Report the error to the host system operator.
<b>E7</b>	<b>41</b>	Facility not supported. Report problem to the host system operator.
<b>E8</b>	<b>46</b>	Call from unexpected DTE. Make sure that the network address is correct. Retry the operation. If the problem continues, report the error to the host system operator.



SNA Diagnostic Codes (ff)	ISO Diagnostic Codes (ff)	Meaning and Recovery Procedure
E9		<p>Invalid D-bit requested.</p> <p>There is a host system problem or you are connected to the wrong DTE. Report the problem to the host system operator.</p>
EA		<p>Reset indication on virtual call.</p> <p>Retry the operation. If the error recurs, report the problem to the host system operator.</p>
EB		<p>Invalid protocol identifier.</p> <p>Make sure that the LLC protocol entered (in the configuration or manually entered) is correct. Retry the operation. If the error recurs, report the problem to the host system operator.</p>
EC		<p>Password mismatch.</p> <p>Make sure that the password is correct. Retry the operation. If the error recurs, report the problem to the host system operator.</p>
	00	<p>No additional information.</p> <p>Report the problem to the host system operator.</p>
	20	<p>Packet not allowed.</p> <p>Report the problem to the host system operator.</p>

## 1200ff or 1280ff System Reference Codes

The IBM 5394 issued a Reset Request packet after detecting an error.

The cause code is contained in the diagnostic field (ff). The cause codes that apply to the 1200ff and 1280ff SRCs follow.

If one of the following SRCs is shown, contact your supervisor because you will have to restart the job. To restart communication, go to Chapter 6, "Communicating with Your Host System" on page 63.

SNA Diagnostic Codes (ff)	ISO Diagnostic Codes (ff)	Meaning and Recovery Procedure
1B	1B	Invalid packet type for state d1. Retry the operation. You may be allowed temporary operation. However, you should report the error to the network service representative.
33	33	Reset confirmation not received within 200 seconds. Report the problem to the host system operator.
50		General ELLC/QLLC error. Report the problem to the host system operator.
51		Undefined ELLC C-field. Report the problem to the host system operator.
54		Undefined ELLC I-field. Report the problem to the host system operator.
55		ELLC I-field too long. Report the problem to the host system operator.
56		ELLC frame reject received. Report the problem to the host system operator.
57		ELLC header invalid. Report the problem to the host system operator.
59		ELLC timeout (LT1 x LN2) condition. Report the problem to the host system operator.
5A		ELLC receive sequence count (LNr) invalid. Report the problem to the host system operator.
5B		ELLC recovery rejected/terminated. Report the problem to the host system operator.

<b>SNA Diagnostic Codes (ff)</b>	<b>ISO Diagnostic Codes (ff)</b>	<b>Meaning and Recovery Procedure</b>
<b>60</b>		General PSH error. Host system or network problem. Report the error to the host system operator.
<b>61</b>		PSH sequence error. Host system or network problem. Report the error to the host system operator.
<b>A1</b>		Invalid M-bit packet sequence. Report the problem to the host system operator.
<b>A6</b>	<b>26</b>	Packet too short. Make sure that the packet size entered (in the configuration or manually entered) matches the network subscription.
<b>A7</b>	<b>27</b>	Packet too long. Make sure that the packet size entered (in the configuration or manually entered) matches the network subscription.
<b>AA</b>		Interrupt packet not supported. Report the error to the host system operator.
<b>AB</b>	<b>01</b>	Invalid packet send sequence number (Ps). Report the error to the network service representative.
<b>AC</b>	<b>02</b>	Invalid packet receive sequence number (Pr). Report the error to the network service representative.
<b>AD</b>		Invalid D-bit received. Report the error to the host system operator.
<b>D0</b>	<b>F4</b>	General resources. Retry the operation. Other applications may operate normally. However, you should report the error to the host system operator.
<b>D2</b>	<b>F5</b>	PIU too long. Retry the operation. Other application may operate normally. However, you should report the error to the host system operator.
	<b>00</b>	No additional information. Report the problem to the host system operator.
	<b>20</b>	Packet not allowed. Report the problem to the host system operator.

## 18ccdd, 19ccdd, and 1Accdd System Reference Codes

SRCs between 180000 and 1AFFFF have the following format:

### TTccdd

TT = General error category (18, 19, or 1A)

cc = Cause code

dd = Diagnostic code.

A description of each error category and its cause codes follows. For the diagnostic codes for all errors in this range, see "Diagnostic Codes for 18ccdd, 19ccdd, and 1Accdd Errors" on page 184.

### Notes:

1. Most cause codes (cc) and diagnostic codes (dd) are issued by the network and may vary from network to network.
2. The cause codes and diagnostic codes listed here are defined by CCITT Recommendation X.25. IBM does not guarantee that they will apply to the network.

**18ccdd Cause Codes:** The data circuit-terminating equipment (DCE) issued a Clear Indication packet after detecting an error.

If one of the following codes is shown, contact your supervisor because you will have to restart the job. To restart communication, go to Chapter 6, "Communicating with Your Host System" on page 63.

Cause Code (cc)	Meaning and Recovery Procedure
00	Call clearing originated at host system. Report the error to the host system operator.
01	Host busy. Wait. Then retry the operation.
03	Invalid facility request. Make sure that the facility request was entered correctly and retry the operation. If the error recurs, report the problem to the network service representative.
05	Network congestion. Wait. Then retry the operation. If the error recurs, report the problem to the network service representative and the host system operator.
09	Out of order - host not ready. Wait. Then retry the operation. If the error recurs, report the problem to the network service representative and the host system operator.
0B	Access to the host not allowed. Make sure that you entered the correct network address for the host system. Then retry the operation. If the problem continues, report the error to the host system operator.

<b>Cause Code (cc)</b>	<b>Meaning and Recovery Procedure</b>
<b>0D</b>	<p>Unrecognized host network address.</p> <p>Make sure that you entered the correct network address for the host system. Then retry the operation. If the problem continues, report the error to the host system operator.</p>
<b>11</b>	<p>Error at the host system.</p> <p>Report the error to the host system operator. Include the diagnostic code (dd).</p>
<b>13</b>	<p>Error at the IBM 5394.</p> <p>Look at the diagnostic code (dd). Retry the operation. If the error recurs, report it to the person who planned the procedures.</p>
<b>15</b>	<p>Recognized Private Operating Agency (RPOA) out of order.</p> <p>Make sure that the correct RPOA facility is selected or select a different RPOA. If the error recurs, report the problem to the host system operator.</p>
<b>19</b>	<p>Reverse charging not subscribed.</p> <p>Make sure that you entered the correct host system address and the correct number for the reverse charge. Retry the operation. If the error recurs, report the problem to the host system operator.</p>
<b>21</b>	<p>Incompatible destination.</p> <p>Make sure that you entered the correct address. If the address is correct, report the problem to the host system operator.</p>
<b>29</b>	<p>Fast select not subscribed.</p> <p>Make sure that call establishment is correct. This facility should not be selected.</p>
<b>80-FF</b>	<p>Call clearing originated at host system.</p> <p>Report the error to the host system operator.</p>

**19ccdd Cause Codes:** The DCE issued a Reset Indication packet after detecting an error.

If one of the following codes is shown, contact your supervisor because you will have to restart the job. To restart communication, go to Chapter 6, "Communicating with Your Host System" on page 63.

<b>Cause Code (cc)</b>	<b>Meaning and Recovery Procedure</b>
<b>00</b>	Reset originated at host system. Report the error to the host system operator.
<b>01</b>	Out of order - disconnected host system. Wait. Then retry the operation. If the error recurs, report the problem to the network service representative and the host system operator.
<b>03</b>	Error at the host system. Report the error to the host system operator. Include the diagnostic code (dd).
<b>05</b>	Error at the IBM 5394. Look at the diagnostic code (dd). Retry the operation. If the error recurs, report it to the person who planned the procedures.
<b>07</b>	Network congestion. Wait. Then retry the operation. If the error recurs, report the problem to the network service representative and the host system operator.
<b>09</b>	Remote DTE operational. This is not an error. It is a normal condition at startup.
<b>0F</b>	Network operational. This is not an error. It is a normal condition at startup.
<b>11</b>	Incompatible destination. Make sure that you entered the correct address. If the address is correct, report the problem to the host system operator.
<b>1D</b>	Network out of order. Retry the operation. If the error recurs, report the problem to the network service representative and the host system operator.
<b>80-FF</b>	Reset originated at host system. Report the error to the host system operator.

**1Accdd Cause Codes:** The DCE issued a Restart.

If one of the following codes is shown, contact your supervisor because you will have to restart the job. To restart communication, go to Chapter 6, "Communicating with Your Host System" on page 63.

Cause Code (cc)	Meaning and Recovery Procedure
00	DTE (host) originated. This is not an error.
01	Local procedure error. Look at the diagnostic code (dd). Retry the operation. If the error recurs, report it to the network planner.
03	Network congestion. Retry the operation. If the error recurs, report the problem to the network service representative and the host system operator.
07	Network is operational. This is not an error. This is a normal condition at startup.
7F	Registration/cancelation confirmed. This is not an error.

**Diagnostic Codes for 18ccdd, 19ccdd, and 1Accdd Errors:** The diagnostic codes (dd) listed here are defined by CCITT Recommendation X.25. IBM does not guarantee that they will apply to your network. You should consult a representative of your network to determine the diagnostic codes that apply to you.

Diagnostic Code (dd)	Description
00	No additional information
01	Invalid send sequence - P (S)
02	Invalid receive sequence - P (R)
10	Invalid packet type
11	State r1
12	State r2
13	State r3
14	State p1
15	State p2

<b>Diagnostic Code (dd)</b>	<b>Description</b>
<b>16</b>	State p3
<b>17</b>	State p4
<b>18</b>	State p5
<b>19</b>	State p6
<b>1A</b>	State p7
<b>1B</b>	State d1
<b>1C</b>	State d2
<b>1D</b>	State d3
<b>20</b>	Packet not allowed
<b>21</b>	Unidentifiable packet
<b>22</b>	Call on one-way logical channel
<b>23</b>	Invalid packet type on a permanent virtual circuit
<b>24</b>	Packet on unassigned logical circuit
<b>25</b>	Reject not subscribed to
<b>26</b>	Packet too short
<b>27</b>	Packet too long
<b>28</b>	Invalid general format identifier
<b>29</b>	Restart with LCID not equal X'000'
<b>2A</b>	Packet type not compatible with facility
<b>2B</b>	Unauthorized interrupt confirmation
<b>2C</b>	Unauthorized interrupt
<b>2D</b>	Unauthorized reject
<b>30</b>	Timer expired, general
<b>31</b>	Timer expired for incoming call
<b>32</b>	Timer expired for clear indication
<b>33</b>	Timer expired for reset indication
<b>34</b>	Timer expired for restart indication
<b>40</b>	Call setup or clearing problem
<b>41</b>	Facility code not allowed



<b>Diagnostic Code (dd)</b>	<b>Description</b>
42	Facility parameter not allowed
43	Invalid called address
44	Invalid calling address
45	Invalid facility/registration length
46	Incoming call barred
47	No logical channel available
48	Call collision
49	Duplicate facility requested
4A	Nonzero address length
4B	Nonzero facility length
4C	Facility not provided when expected
4D	Invalid CCITT-specified DTE facility
50	Miscellaneous problems
51	Improper cause code from DTE
52	Not aligned octet
53	Inconsistent Q bit setting
60-6F	Not assigned
70	International problem
71	Remote network problem
72	International protocol problem
73	International link out of order
74	International link busy
75	Transit network facility problem
76	Remote network facility problem
77	International routing problem
78	Temporary routing problem
79	Unknown called DNIC
7A	Maintenance action
80-FF	Network specific diagnostic information

## 1Bcc00 System Reference Codes

The IBM 5394 issued a Restart Request packet after detecting an error.

The cause code (cc) is contained in the cause field. The cause codes that apply to the 1Bccyy SRC follow.

SNA Cause Code (cc)	ISO Cause Codes (cc)	Description
11	11	Unsolicited Restart Confirmation received
34	34	Restart Confirmation packet not received within 200 seconds
A5	A5	Diagnostic packet received (see note)
A6	A6	Packet too short
A7	A7	Packet too long
A8	28	Invalid GFI (Restart Indication/Confirmation only)
E2	29	LCID is not equal to 0 on Restart Indication/Confirmation
E5	24	LCID = 0 on non-Restart/Diagnostic packet.
<b>Note:</b> The SRC for diagnostic packet received has two additional descriptive characters appended, 1BA5yy, for example. The definitions of yy are described in <i>The X.25 Interface for Attaching IBM SNA Nodes to Packet-Switched Data Networks, General Information Manual</i> . This packet does not generate a restart request.		

## X.21 Switched Operator System Reference Codes

If the IBM 5394 is in X.21 switched communication mode and an error occurs during the keyboard entry of commands, options, or parameters, a six-digit SRC between 200000 and 20FFFF is displayed.

SRC	Meaning and Recovery Procedure
200000	A CALL command is already in progress (not in session). Wait until the CALL command is complete, or an SRC other than 200000 is displayed.
200100	DETACH command accepted. Call clearing in progress. Try to make another call.
200200	You attempted a DETACH command while a CALL command was in progress or when no circuit connection existed. Wait until the previous command completes. Then try again. If no command was in progress, try to make a call.

## X.21 Switched Communication System Reference Codes

If the IBM 5394 accepts the keyboard-entered options, but the network operation with the host system fails, a code that indicates the type of communication problem is shown on the attached work stations.

The 21xx00 and 23xx00 SRCs occur when a call progress signal is received from the network (where xx is the call progress signal code).

If the recovery procedure indicates that the call can be retried, the time period you must wait between calls and the maximum number of calls you can attempt in a series are dependent upon the network to which you are attached. Contact your network supplier to determine these values.

<b>SRC</b>	<b>Meaning and Recovery Procedure</b>
<b>210100</b>	<p>The incoming call was received by the host system. Communication should be established shortly.</p> <p>Wait 1 minute or until a different SRC is displayed. This status is temporary.</p>
<b>210200</b>	<p>The call is being redirected to a number other than the one entered.</p> <p>Wait 1 minute or until a different SRC is displayed. This status is temporary.</p>
<b>210300</b>	<p>The call was queued and communication will be established when the host system is not busy.</p> <p>Wait 1 minute or until a different SRC is displayed. This status is temporary.</p>
<b>210400</b>	<p>A private network was reached.</p> <p>Wait 1 minute or until a different SRC is displayed. This status is temporary.</p>
<b>210500</b>	<p>A public network was reached.</p> <p>Wait 1 minute or until a different SRC is displayed. This status is temporary.</p>
<b>212000</b>	<p>There is no connection.</p> <p>Make sure that the number called is correct and try the operation again. This is a DCE or a network error.</p>
<b>212100</b>	<p>The number is busy.</p> <p>Make sure that the number called is correct and try the call again. If the number is busy for longer than normal, call the host system operator to see if the system port for the number called is actually busy. If the host system port and the DCE for the number called is ready and not busy, there is a network problem.</p>
<b>212200</b>	<p>There is a procedure error in the selection signals sent to the network (for example, incorrect format).</p> <p>Make sure that the operating procedures are correct and try the operation again. If the same failure occurs, the problem is caused by the DCE or the network.</p>
<b>212300</b>	<p>The network detected a transmission error in the selection signals.</p> <p>Make sure that the number called is correct and try the operation again. This is a DCE or a network error.</p>
<b>214100</b>	<p>Access is barred. The IBM 5394 is not allowed to connect to the host system.</p> <p>Make sure that the number called is correct and that the operating procedures and configuration are compatible with the network subscription for the control unit and the host system location. If the procedures and configuration are correct and compatible, the failure is a network problem.</p>

<b>SRC</b>	<b>Meaning and Recovery Procedure</b>
<b>214200</b>	<p>The number you are calling has changed.</p> <p>Make sure that the number called is correct and that the operating procedures and configuration are compatible with the network subscription for the IBM 5394 and the host system location. If the procedures and configuration are correct and compatible, the failure is a network problem.</p>
<b>214300</b>	<p>The called DTE address is not valid or not assigned to any DTE, or the user class of service is not compatible.</p> <p>Make sure that the number called is correct and that the operating procedures and configuration are compatible with the network subscription for the IBM 5394 and the host system location. If the procedures and configuration are correct and compatible, the failure is a network problem.</p>
<b>214400</b>	<p>The number you called is out of order.</p> <p>Make sure that the number called is correct, that the host system you called and the DCE are on and ready, and that the IBM 5394 is brought online by the host system operator. If the host system and DCE are on and ready, and the control unit is online, then the failure is a network problem.</p>
<b>214500</b>	<p>The called DTE is signaling controlled-not-ready.</p> <p>Make sure that the number called is correct, that the host system you called and the DCE are on and ready, and that the IBM 5394 is brought online by the host system operator. If the host system and DCE are on and ready, and the control unit is online, then the failure is a network problem.</p>
<b>214600</b>	<p>The called DTE is signaling uncontrolled-not-ready.</p> <p>Make sure that the number called is correct, that the host system you called and the DCE are on and ready, and that the IBM 5394 is brought online by the host system operator. If the host system and DCE are on and ready, and the control unit is online, then the failure is a network problem.</p>
<b>214700</b>	<p>The called DCE is powered off.</p> <p>Make sure that the number called is correct, that the host system you called and the DCE are on and ready, and that the IBM 5394 is brought online by the host system operator. If the host system and DCE are on and ready, and the control unit is online, then the failure is a network problem.</p>
<b>214800</b>	<p>The facility request code is not valid.</p> <p>Make sure that the facility request code is correct and that the operating procedures and configuration are compatible with the network subscription for the IBM 5394 and the host system location. If the procedures and configuration are correct and compatible, the failure is a network problem.</p>
<b>214900</b>	<p>There is a network problem in the local loop at the DCE you called.</p> <p>Make sure that the number called is correct and that the operating procedures and configuration are compatible with the network subscription for the IBM 5394 and the host system location. If the procedures and configuration are correct and compatible, the failure is a network or DCE problem.</p>
<b>215100</b>	<p>The number called cannot be obtained.</p> <p>Make sure that the number called is correct and that the operating procedures and configuration are compatible with the network subscription for the IBM 5394 and the host system location. If the procedures and configuration are correct and compatible, the failure is a network or DCE problem. Call the network information service to find out why the number called is temporarily unobtainable.</p>

SRC	Meaning and Recovery Procedure
215200	<p>The user class of service is not compatible.</p> <p>Make sure that the number called is correct and that the operating procedures and configuration are compatible with the network subscription for the IBM 5394 and the host system location. If the procedures and configuration are correct and compatible, the failure is a network problem.</p>
216100	<p>The network is congested.</p> <p>Make sure that the number called is correct and try the operation again. This is a network error.</p>
217100	<p>There is long-term network congestion.</p> <p>Make sure that the number called is correct. Some networks allow retry after a wait period. This is a network error.</p>
217200	<p>The Recognized Private Operating Agency (RPOA) is out of order.</p> <p>The failure is caused by an RPOA problem or a network problem. Report the problem to the RPOA representative.</p>
218100	<p>The registration or cancelation is confirmed.</p> <p>This is a confirmation of the facility registration or cancelation, not an error.</p>
218200	<p>Redirection of the call facility is activated.</p> <p>This is a response to a status inquiry, not an error.</p>
218300	<p>Redirection of the call facility is deactivated.</p> <p>This is a response to a status inquiry, not an error.</p>
219x00	<p>Codes reserved for national purposes.</p> <p>If this code appears, call the network supplier to determine the meaning of the call progress signal 9x.</p>
220000	<p>An invalid XID was received (invalid Short Hold indicators).</p> <p>Make sure that the number called was correct. If the number called was correct, there is a host system programming error or a configuration problem.</p>
220100	<p>An invalid XID was received (more than 27 digits were received or the number of digits received does not equal the number of digits specified for Short Hold mode).</p> <p>Make sure that the number called was correct. If the number called was correct, there is a host system programming error or a configuration problem.</p>
220200	<p>The wrong XID was received.</p> <p>Make sure that the number called was correct. If the number called was correct, there is a host system programming error or a configuration problem.</p>
220300	<p>An XID was required and was not received first.</p> <p>Make sure that the number called was correct. If the number called was correct, there is a host system programming error or a configuration problem.</p>
220400	<p>A DCE clear was received during call selection.</p> <p>The failure is caused by a network or DCE problem. Report the problem to the network service representative.</p>
220500	<p>There was a transition to SDLC during a message.</p> <p>The failure is caused by a network or DCE problem. Report the problem to the network service representative.</p>

<b>SRC</b>	<b>Meaning and Recovery Procedure</b>
<b>220600</b>	An X.21 message was too long for the buffer. The failure is caused by a network or DCE problem. Report the problem to the network service representative.
<b>220700</b>	An attempt was made to send an X.21 message to the network in SDLC state. Contact your customer service representative and report the SRC.
<b>220800</b>	An attempt was made to send an SDLC frame to the network in X.21 state. Contact your customer service representative and report the SRC.
<b>220900</b>	An X.21 message was received in the not ready queue. Contact your customer service representative and report the SRC.
<b>221101</b>	A timeout (T1) for call-request response occurred. The failure is caused by a network or DCE problem. This error can occur if the host configuration does not match the IBM 5394 configuration. Make sure that the Test/Oper switches on the communication cable are in the OPER position. If the failure recurs with the switches set to OPER, report the problem to the network service representative.
<b>221102</b>	A timeout (T2) for selection-signal response occurred. The failure is caused by a network or DCE problem. Report the problem to the network service representative.
<b>221103</b>	A timeout (T3A or T3B) for call-progress-signal response occurred. The failure is caused by a network or DCE problem. Report the problem to the network service representative.
<b>221104</b>	A timeout (T4B) for call-accepted response occurred. The failure is caused by a network or DCE problem. Report the problem to the network service representative.
<b>221105</b>	A timeout (T5) for DTE-clear-request occurred. The failure is caused by a network or DCE problem. Report the problem to the network service representative.
<b>221106</b>	A timeout (T6) for DTE-clear-confirmation occurred. The failure is caused by a network or DCE problem. Report the problem to the network service representative.
<b>221300</b>	A call-collision error occurred. Try the operation again. If the error occurs again, contact your customer service representative and report the SRC.
<b>221400</b>	A DCE clear was received during X.21 data-transfer state. Connection to the host system was lost. Make sure that the number called is correct. If the number called is correct, there is a host system or network problem.
<b>221500</b>	The received XID indicated that the host system was busy at the network address you typed in. Wait until the host system is not busy, or try a different address.
<b>23xx00</b>	A call progress signal was received from the network, but a call was not placed. The failure is caused by a network or DCE problem. Report the problem to the network service representative.
<b>240000</b>	The DTE received an invalid call progress signal. The failure is caused by a network or DCE problem. Report the problem to the network service representative.

## V.25 bis Operator System Reference Codes

If the IBM 5394 is in SDLC communication mode and an error occurs during the V.25 bis call establishment or call clearing procedure, a six-digit SRC between 300000 and 30FFFF is displayed on the screen. Find your SRC in the following table and follow the recovery procedures given.

SRC	Meaning and Recovery Procedure
300000	Call request not allowed. Link is not established or another call is in progress. Wait 30 seconds to retry the call or until an SRC other than 300000 is displayed.
300100	DETACH command accepted. Call clearing in progress. If necessary, try to make another call.
300200	Call clearing not allowed. Do not attempt call clearing at this time.
300300	Call request entered with no call information. Enter call information from the Applications Worksheet.

## V.25 bis Call Indication System Reference Codes

If a request for an outgoing call fails, an SRC between 310000 and 31FFFF is displayed on the screen.

SRC	Meaning and Recovery Procedure
3101pp	<p>Call Failure Indication received. "pp" = one of the following parameters:</p> <p>ET Engaged Tone            CB Local DCE Busy            RT Ring Tone (timeout)            AB Abort Call (timeout)            NT Answer Tone Not Detected            FC Forbidden Call (for nationally dependent parameters)</p> <p><b>Note:</b> The IBM 5394 may receive other parameters that indicate a problem in the DCE.</p>
3102nn	<p>Delayed Call Indication received. "nn" = time in minutes.</p> <p><b>Note:</b> "nn=99" could indicate a number greater than 99.</p>
310300	Invalid Call Indication received.

## V.25 bis Circuit-Terminating System Reference Codes

If a call is ended during call establishment because of an error, an SRC between 320000 and 3FFFFFF is displayed on the screen. Find your SRC in this table and follow the recovery procedures given.

SRC	Meaning and Recovery Procedure
320100	A V.25 bis message transmission error occurred.
320600	A V.25 bis message was too long for the buffer.
320900	A V.25 bis message was received in the not ready queue.
321000	An RFS timeout occurred during call establishment.
321100	A call-connected timeout occurred for an outgoing call.
321200	A call-connected timeout occurred for an incoming call.
322000	A call collision error occurred.
322100	An incoming call was rejected in invalid state.
323100	A message containing fewer than 3 characters was received.
323300	A corrupt or invalid call failure indication parameter was received.
323400	A delayed call failure indication was received with no time indicated.



## Diskette Drive and Diskette System Reference Codes

If a problem occurs during control unit operation, a six-digit SRC is displayed on all active display stations. Find the SRC in this table and follow the recovery procedures given.

SRC	Meaning and Recovery Procedure
500001	<p>Configuration, error log, microcode change, or translate table data cannot be read from the system diskette.</p> <p>To recover, set the control unit power switch to off (O), replace the system diskette with the backup diskette, and set the power switch to on (I). If the problem continues, contact your customer service representative. If the backup diskette corrects the problem, see Appendix H, "Ordering Replacement System Diskettes" on page 207 to obtain new system diskettes.</p>
500002	<p>System diskette contains configuration parameters not supported by this model.</p> <p>The system diskette used to operate the IBM 5394 should be the same diskette used for that individual control unit during customer setup. Either replace the diskette with the correct system diskette, or use the diskette to do the customer setup procedure again.</p>
500003	<p>System diskette is not compatible with hardware.</p> <p>To recover, see Appendix H, "Ordering Replacement System Diskettes" on page 207 to obtain the latest level IBM 5394 system diskette.</p>
500004	<p>You are using the wrong diskette.</p> <p>To recover, replace the diskette with a valid system diskette.</p>
500005	<p>The system diskette you are using is write-protected.</p> <p>To recover, remove the diskette, close the write-protect tab, and reinsert the diskette.</p> <p>If the error occurred during the configuration procedure or concurrent diagnostics, press the Error Reset key to clear the error and retry the operation.</p> <p>If the error occurred during the power-on sequence, set the control unit power switch to off (O), and then back to on (I).</p>
500006	<p>An error occurred when you tried to write information to the system diskette, or you tried to save configuration information from a Release 2 or later system diskette to a Release 1 diskette.</p> <p>If the error occurred when you tried to write information to the system diskette, replace the system diskette with the backup diskette. If the problem occurred during the configuration procedure, press the Error Reset key. Retry the operation. If necessary, see Appendix H, "Ordering Replacement System Diskettes" on page 207 to obtain new system diskettes.</p> <p>If the error occurred when you attempted to save configuration information to a Release 1 diskette, replace the Release 1 diskette with a Release 2 or later diskette before trying to save configuration information.</p> <p>If the SRC reappears, contact your customer service representative.</p>
500007	<p>See Appendix H, "Ordering Replacement System Diskettes" on page 207 to obtain new system diskettes with the current microcode level. The current level is an updated and improved version of what you already have and is available to you at no cost. Continue to operate your IBM 5394 with your present system diskette until your updated diskette arrives.</p>

## Microcode Change System Reference Codes

If an error is detected when changes from the system diskette or from the host system are applied, a six-digit SRC between 510000 and 51FFFF is displayed. Find the range for your SRC and follow the recovery procedures given.

SRC	Meaning and Recovery Procedure
5101xx	<p>A problem occurred while applying or removing changes contained in the microcode change file on the system diskette.</p> <p>Retry the power-on sequence. If the problem recurs, insert the backup diskette. Set the power switch to off and then back to on.</p> <p>If the problem occurs with the backup diskette, contact your customer service representative. If necessary, see Appendix H, "Ordering Replacement System Diskettes" on page 207 to obtain a new backup diskette.</p>
5102xx	<p>A problem occurred while applying changes contained in the microcode change file from the host system.</p> <p>To recover, restart communication. If the problem recurs, contact your host system operator.</p>

## Copy-to-Printer and Local Copy System Reference Codes

If an error is detected during a copy-to-printer operation, an SRC between 520000 and 52FFFF is displayed on the screen. Find the SRC in this table and follow the recovery procedures given.

SRC	Meaning and Recovery Procedure
520000	<p>The IBM 5394 did not find a printer that was available for local copy-to-printer operation.</p> <p>To recover, press the Error Reset key. Make sure that a printer is powered on, online, and available, and retry the operation.</p>
520001	<p>The device at the address selected for the copy-to-printer operation is not a printer.</p> <p>Your configuration may be incorrect. To check the configuration, go to "Beginning Configuration" on page 32 and display the configuration screen. Make sure that the settings for Field P match the actual port number and station address of the printer you want to use for copy-to-printer operations.</p>
520002	<p>The designated printer is in session, powered off, or in error state; or no device is powered on at this address.</p> <p>To recover, press the Error Reset key. If the designated printer is in session, wait until printing is completed and retry the operation. Otherwise, correct any error conditions at the printer and retry the operation.</p>
520003	<p>The IBM 5394 lost communication with the printer while the print operation was in progress.</p> <p>Press the Error Reset key. If you want to restart the print job, make sure that the printer is powered on and online, and correct any error conditions. Retry the operation.</p>

## Power-On Sequence System Reference Codes

If an error is detected during the power-on sequence, an SRC between D10000 and DFFFFF is displayed on the screen. Find the SRC in this table and follow the recovery procedures given.

SRC	Meaning and Recovery Procedure
<b>D73xA2</b>	<p>Twinaxial port error.</p> <p>Check for proper termination of your twinaxial cables. Set the control unit power switch to off (O) and then to on (I). If the error occurs again, remove the twinaxial cables from the IBM 5394 twinaxial ports. Set the control unit power switch to off (O) and then to on (I). If the error occurs again, contact your customer service representative and report the SRC.</p> <p>If the error does not occur with the twinaxial cables removed from the IBM 5394, you have a problem with either your cabling or your work stations. Follow local procedures for obtaining service for your cable and work stations.</p>
<b>Other Dxxxxx</b>	<p>Record the SRC.</p> <p>Set the control unit power switch to off (O) and then to on (I). If the error occurs again, contact your customer service representative and report the SRC.</p>

---

## Appendix F. Key Sequences

The illustrations on the following pages show the keyboards supported by the IBM 5394. All keys used in this book are labeled.

Four key sequences are used in this book:

- Test Request key sequence

The Test Request key sequence displays the configuration screen and the extended test screen.

- System Request key sequence

The System Request key sequence displays the screen to establish or end communication with the host system.

- Local Copy key sequence

The Local Copy key sequence allows you to print a currently displayed screen.

- Read Configuration key sequence

The Read Configuration key sequence displays configuration data from an existing system diskette.

These sequences are different for each keyboard. All key sequences are defined after each illustration. Find your display station keyboard and note the keys you will be using.

# IBM Typewriter Keyboard

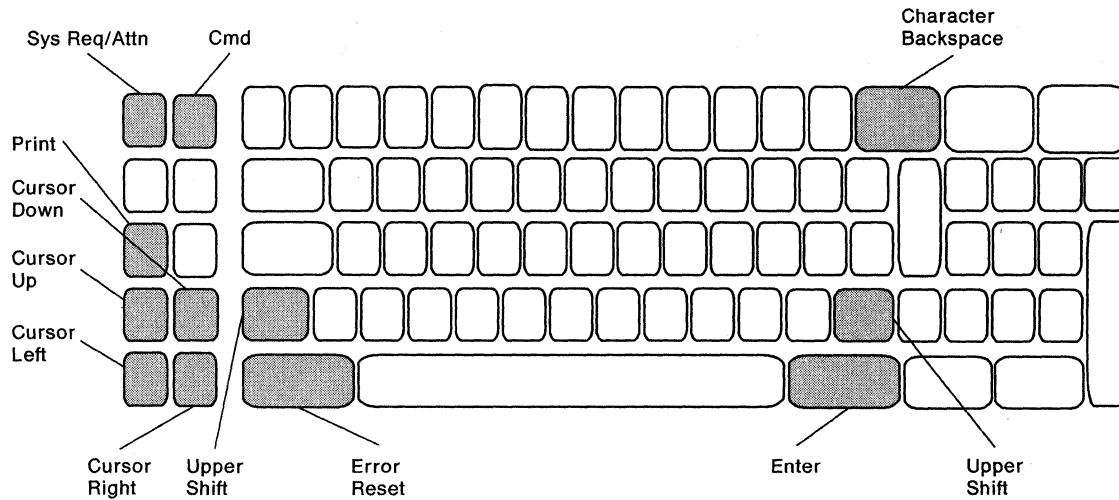

## Test Request Key Sequence

1. Press the Error Reset key.
2. Press the Command (Cmd) key.
3. Press the Character Backspace (←) key.

## System Request Key Sequence

1. Press the Error Reset key.
2. Press and hold the Upper Shift key.
3. Continue to hold the Upper Shift key and press the Sys Req/Attn key.

## Local Copy Key Sequence

Press the Print key.

## Read Configuration Key Sequence

1. Press the Command (Cmd) key.
2. Press the Cursor Up key.

# IBM Typewriter Data Entry Keyboard

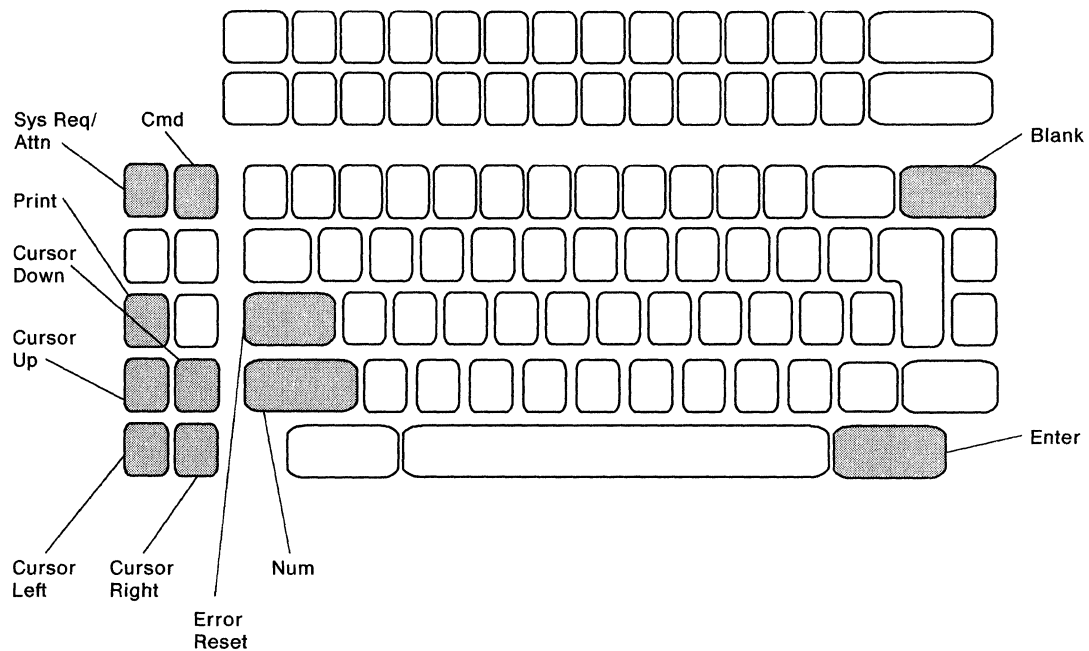

## Test Request Key Sequence

1. Press the Error Reset key.
2. Press the Command (Cmd) key.
3. Press the blank key in the upper right-hand corner.

## System Request Key Sequence

1. Press the Error Reset key.
2. Press and hold the Num key.
3. Continue to hold the Num key and press the Sys Req/Attn key.

## Local Copy Key Sequence

Press the Print key.

## Read Configuration Key Sequence

1. Press the Command (Cmd) key.
2. Press the Cursor Up key.

# IBM 122-Key Keyboard

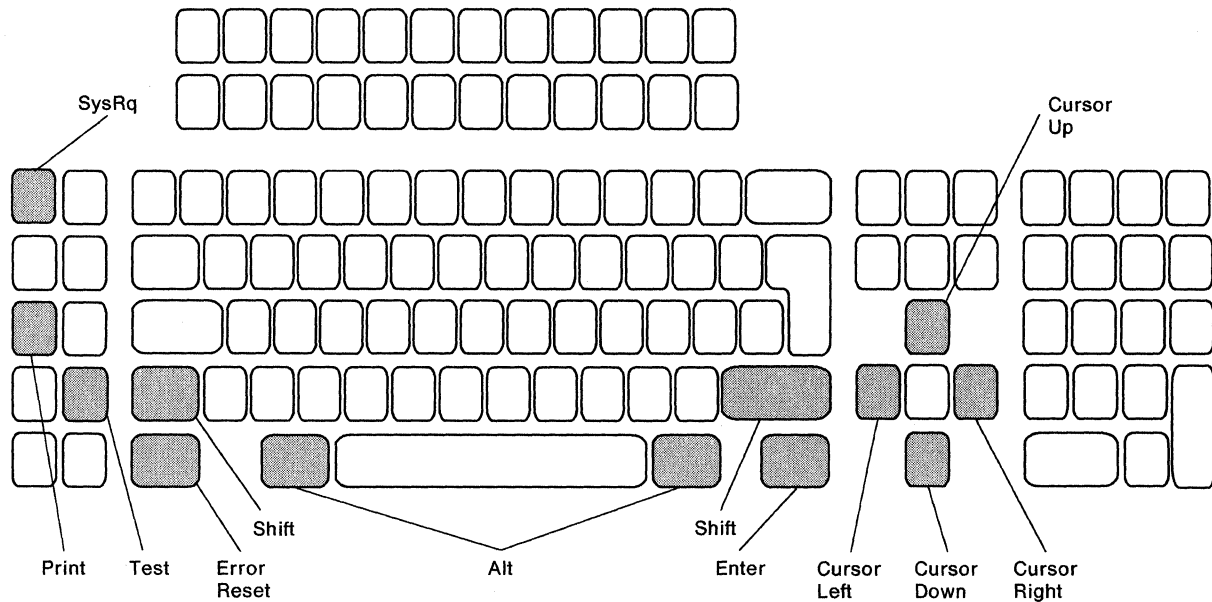

## Test Request Key Sequence

1. Press the Error Reset key.
2. Press and hold the Alt key.
3. Continue to hold the Alt key and press the Test key.

## System Request Key Sequence

1. Press the Error Reset key.
2. Press and hold the Shift key.
3. Continue to hold the Shift key and press the SysRq key.

## Local Copy Key Sequence

Press the Print key.

## Read Configuration Key Sequence

1. Press and hold the Alt key.
2. Continue to hold the Alt key and press the Cursor Up key.

# IBM Enhanced (102-Key) Keyboard

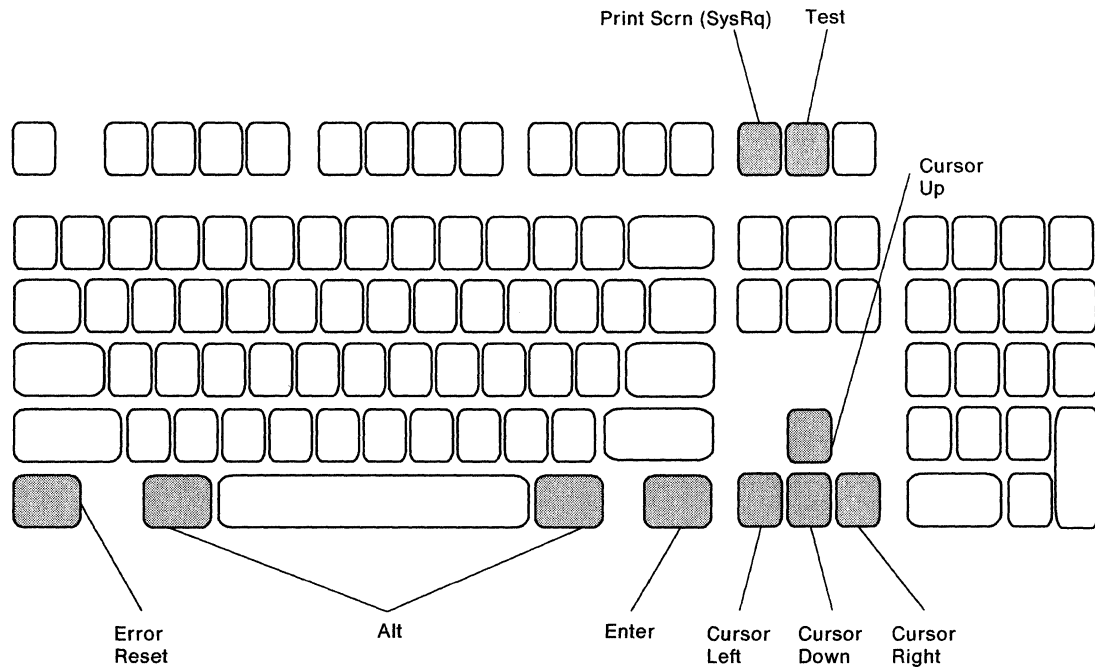

## Test Request Key Sequence

1. Press the Error Reset key.
2. Press and hold the Alt key.
3. Continue to hold the Alt key and press the Test key.

## System Request Key Sequence

1. Press the Error Reset key.
2. Press and hold the Alt key.
3. Continue to hold the Alt key and press the Print Scrn (SysRq) key.

## Local Copy Key Sequence

Press the Print Scrn (SysRq) key.

## Read Configuration Key Sequence

1. Press and hold the Alt key.
2. Continue to hold the Alt key and press the Cursor Up key.



# IBM PC, PC XT, and Portable PC Keyboard

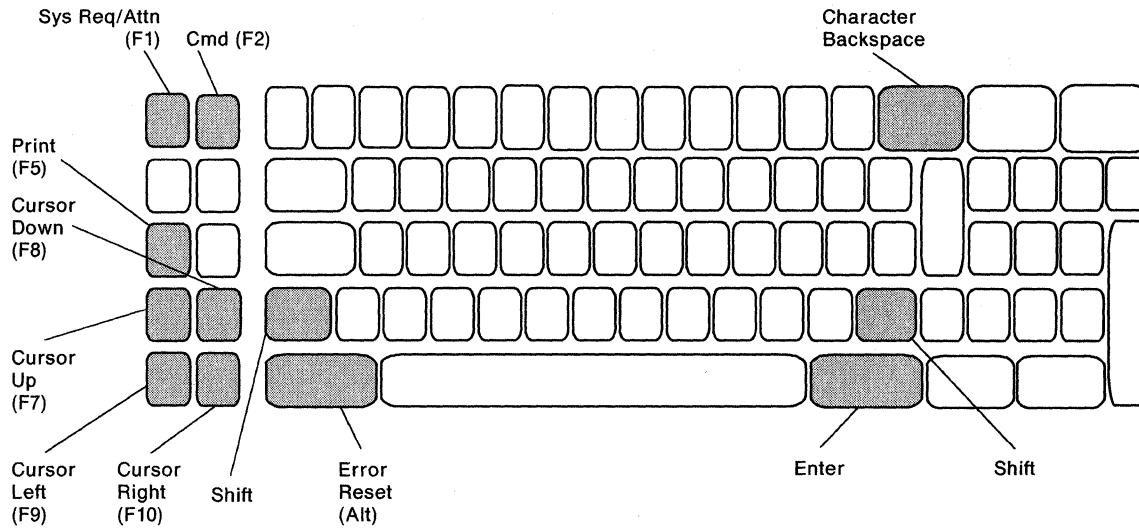

## Test Request Key Sequence

1. Press the Error Reset (Alt) key.
2. Press the Cmd (F2) key.
3. Press the Character Backspace (←) key.

## System Request Key Sequence

1. Press the Error Reset (Alt) key.
2. Press and hold the Shift key.
3. Continue to hold the Shift key and press the Sys Req/Attn (F1) key.

## Local Copy Key Sequence

Press the Print (F5) key.

## Read Configuration Key Sequence

1. Press the Cmd (F2) key.
2. Press the Cursor Up (F7) key.

# IBM Personal Computer AT Keyboard

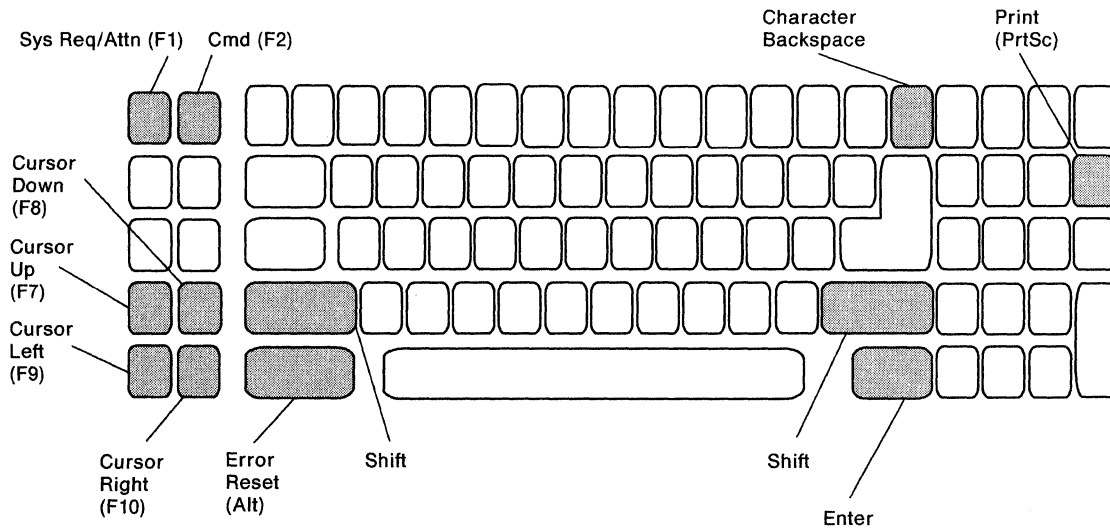

## Test Request Key Sequence

1. Press the Error Reset (Alt) key.
2. Press the Cmd (F2) key.
3. Press the Character Backspace (←) key.

## System Request Key Sequence

1. Press the Error Reset (Alt) key.
2. Press and hold the Shift key.
3. Continue to hold the Shift key and press the Sys Req/Attn (F1) key.

## Local Copy Key Sequence

1. Press and hold the Shift key.
2. Continue to hold the Shift key and press the Print (Prt Sc) key.

## Read Configuration Key Sequence

1. Press the Cmd (F2) key.
2. Press the Cursor Up (F7) key.

# IBM Personal System/2 Keyboard (using IBM System 36/38 Work Station Emulation Program)

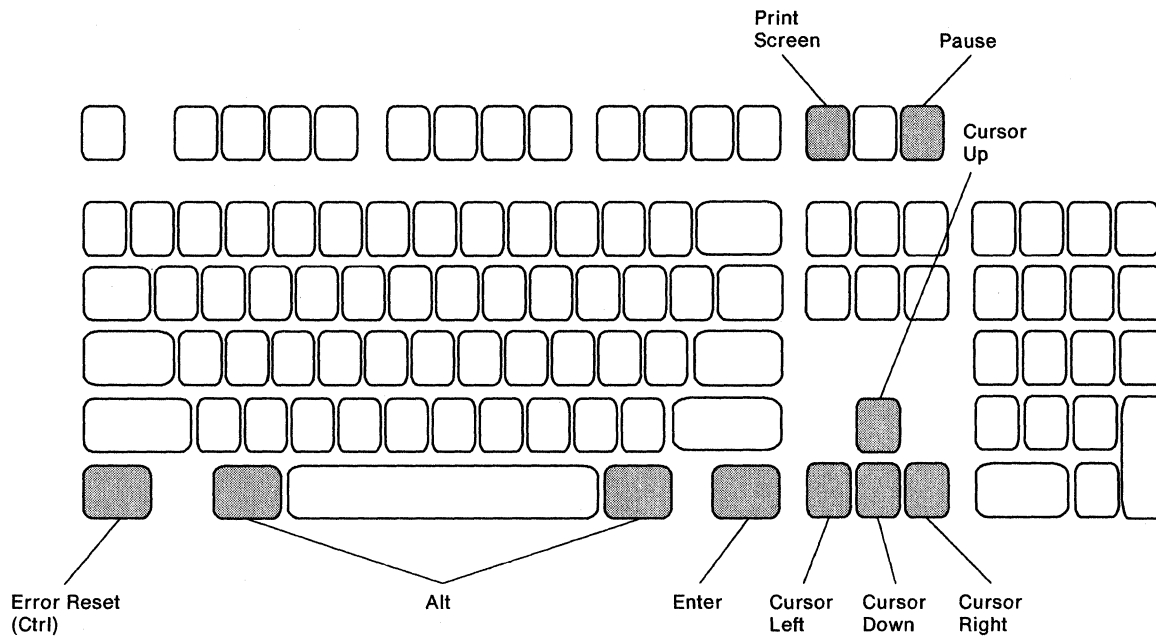

## Test Request Key Sequence

1. Press the Error Reset (Ctrl) key.
2. Press and hold the Alt key.
3. Continue to hold the Alt key and press the Pause key.

## System Request Key Sequence

1. Press the Error Reset (Ctrl) key.
2. Press and hold the Alt key.
3. Continue to hold the Alt key and press the Print Screen key.

## Local Copy Key Sequence

Press the Print Screen key.

## Read Configuration Key Sequence

1. Press and hold the Alt key.
2. Continue to hold the Alt key and press the Cursor Up key.

## Appendix G. Decimal to Hexadecimal Conversion Chart

This appendix contains a chart for converting decimal notations to hexadecimal form.

Decimal	Hex	Decimal	Hex	Decimal	Hex	Decimal	Hex
00	00	32	20	64	40	96	60
01	01	33	21	65	41	97	61
02	02	34	22	66	42	98	62
03	03	35	23	67	43	99	63
04	04	36	24	68	44	100	64
05	05	37	25	69	45	101	65
06	06	38	26	70	46	102	66
07	07	39	27	71	47	103	67
08	08	40	28	72	48	104	68
09	09	41	29	73	49	105	69
10	0A	42	2A	74	4A	106	6A
11	0B	43	2B	75	4B	107	6B
12	0C	44	2C	76	4C	108	6C
13	0D	45	2D	77	4D	109	6D
14	0E	46	2E	78	4E	110	6E
15	0F	47	2F	79	4F	111	6F
16	10	48	30	80	50	112	70
17	11	49	31	81	51	113	71
18	12	50	32	82	52	114	72
19	13	51	33	83	53	115	73
20	14	52	34	84	54	116	74
21	15	53	35	85	55	117	75
22	16	54	36	86	56	118	76
23	17	55	37	87	57	119	77
24	18	56	38	88	58	120	78
25	19	57	39	89	59	121	79
26	1A	58	3A	90	5A	122	7A
27	1B	59	3B	91	5B	123	7B
28	1C	60	3C	92	5C	124	7C
29	1D	61	3D	93	5D	125	7D
30	1E	62	3E	94	5E	126	7E
31	1F	63	3F	95	5F	127	7F

Decimal	Hex	Decimal	Hex	Decimal	Hex	Decimal	Hex
128	80	160	A0	192	C0	224	E0
129	81	161	A1	193	C1	225	E1
130	82	162	A2	194	C2	226	E2
131	83	163	A3	195	C3	227	E3
132	84	164	A4	196	C4	228	E4
133	85	165	A5	197	C5	229	E5
134	86	166	A6	198	C6	230	E6
135	87	167	A7	199	C7	231	E7
136	88	168	A8	200	C8	232	E8
137	89	169	A9	201	C9	233	E9
138	8A	170	AA	202	CA	234	EA
139	8B	171	AB	203	CB	235	EB
140	8C	172	AC	204	CC	236	EC
141	8D	173	AD	205	CD	237	ED
142	8E	174	AE	206	CE	238	EE
143	8F	175	AF	207	CF	239	EF
144	90	176	B0	208	D0	240	F0
145	91	177	B1	209	D1	241	F1
146	92	178	B2	210	D2	242	F2
147	93	179	B3	211	D3	243	F3
148	94	180	B4	212	D4	244	F4
149	95	181	B5	213	D5	245	F5
150	96	182	B6	214	D6	246	F6
151	97	183	B7	215	D7	247	F7
152	98	184	B8	216	D8	248	F8
153	99	185	B9	217	D9	249	F9
154	9A	186	BA	218	DA	250	FA
155	9B	187	BB	219	DB	251	FB
156	9C	188	BC	220	DC	252	FC
157	9D	189	BD	221	DD	253	FD
158	9E	190	BE	222	DE	254	FE
159	9F	191	BF	223	DF	255	FF

---

## Appendix H. Ordering Replacement System Diskettes

If you need to order replacement system diskettes for the IBM 5394, do one of the following:

- **Inside U.S.**

Make sure you have the serial number of your control unit available. Within North Carolina, call 800-672-3301. Outside North Carolina, call 800-334-1089.

- **Outside U.S.**

Make sure you have the serial number of your control unit available. Contact your local IBM Branch Office.



---

## List of Abbreviations and Acronyms

<b>AC</b>	alternating current	<b>ISO</b>	International Standards Organization
<b>bps</b>	bits per second	<b>LAPB</b>	link access protocol-balanced
<b>CCITT</b>	International Telegraph and Telephone Consultative Committee	<b>LCID</b>	logical channel identifier
<b>CDSTL</b>	connect data set to line	<b>LLC</b>	logical link control
<b>C-field</b>	control field	<b>NRZ</b>	nonreturn-to-zero
<b>CPS</b>	call progress signal	<b>NRZI</b>	nonreturn-to-zero-inverted
<b>CSU</b>	customer setup	<b>PSH</b>	physical services header
<b>DCD</b>	data carrier detect	<b>PTT</b>	Post Telephone and Telegraph Administration
<b>DCE</b>	data circuit-terminating equipment	<b>PVC</b>	permanent virtual circuit
<b>DISC</b>	disconnect	<b>QLLC</b>	qualified logical link control
<b>DM</b>	disconnect mode	<b>RFS</b>	ready for sending
<b>DSR</b>	data set ready	<b>RPOA</b>	Recognized Private Operating Agency
<b>DTE</b>	data terminal equipment	<b>RTS</b>	request to send
<b>DTR</b>	data terminal ready	<b>SABM</b>	set asynchronous balanced mode
<b>EBCDIC</b>	extended binary-coded decimal interchange code	<b>SDLC</b>	synchronous data link control
<b>EIA</b>	Electronics Industries Association	<b>SHM</b>	short hold mode
<b>ELLC</b>	enhanced logical link control	<b>SNA</b>	systems network architecture
<b>FRMR</b>	frame reject	<b>SNBU</b>	switched network backup
<b>GFI</b>	general format identifier	<b>SRC</b>	system reference code
<b>I-field</b>	information field	<b>SVC</b>	switched virtual circuit
<b>IPDS</b>	intelligent printer data stream	<b>UA</b>	unnumbered acknowledgment
<b>IPL</b>	initial program load	<b>WT</b>	World Trade
		<b>XID</b>	exchange identifier





---

# Glossary

**alphanumeric.** Pertaining to a character set that contains letters, digits, and usually other characters, such as punctuation marks. Alphanumeric is a synonym for alphanumeric.

**analog network.** A type of communication network that carries analog signals.

**answer command.** A command that is entered from a display station keyboard, and when processed, places the control unit in Answer mode. The control character is A.

**blank character.** A character that does not display but occupies a position on the display screen.

**cable adapter.** A device used to connect two cable ends together. An adapter is used instead of a splice.

**cabling system.** A system of communication wiring installed in a building to connect computers and communication equipment.

**cable-thru.** A method of cabling that allows multiple work stations to be attached to a single cable path.

**call command.** A command that is entered from a display station keyboard, and when processed, places the control unit in Call mode. The control character is C.

**character location.** A location on the display screen at which one character can be displayed.

**circuit type.** A type of circuit that connects two remote locations. Analog circuits and X.21 circuits can be point-to-point switched, point-to-point nonswitched, or multipoint nonswitched. X.25 circuit types can be either PVC or SVC. Either PVC or SVC can be used on the same IBM 5394 but not at the same time.

**clicker.** A mechanism that sounds when a key is pressed.

**closed user group.** A group of locations that can communicate among themselves but cannot call to or receive calls from any location outside the group. However, it is possible to define a different closed user group for a different application. The control character is U. The 2-character variable is supplied by the network.

**command.** An instruction that directs the system to do an operation.

**common carrier.** In the US, a government-regulated private company (such as a telephone or telegraph

company) that furnishes the general public with telecommunication service facilities.

**communication network.** The equipment and software required to transmit data signals between a host system and a remote site.

**configuration.** The arrangement of a computer system or network as defined by the nature, number, and chief characteristics of its functional units. See *system configuration*.

**control unit.** A device that controls the flow of data between work stations and a host computer. Some control units do error checking, error handling, and error recovery procedures, and provide certain editing features to the display station.

**cursor.** A movable marker on the screen that can appear as an underscore or as a rectangular block. The cursor indicates where the next character entered from the keyboard will appear.

**customer setup (CSU).** The unpacking, setup, and checkout of IBM CSU-designated machines by user personnel, according to a sequence of instructions provided by IBM, without the use of tools or help from IBM personnel.

**data circuit-terminating equipment.** The equipment that does the signal conversion and coding between the data terminal equipment (DTE) and the communication line.

**data communication system.** A configuration of data processing devices, software, and a communication network connected for information interchange.

**data link.** The equipment and protocols used for sending and receiving data.

**data management.** The process of controlling the acquisition, analysis, storage, retrieval, and distribution of data.

**data network identification code.** A four-digit code added as a prefix to the network address when the receiving DTE is attached to another network or is located in another country.

**data packet.** The type of data grouping used to send information from one DTE to another DTE attached to an X.25 packet-switched network.

**data terminal equipment (DTE).** Any machine, such as the IBM 5394 or its host computer, that is connected to a network.

**delimiter.** A character used to indicate the beginning and end of a character string.

**detach command.** A command that is entered from a display station keyboard, and when processed, ends the data link between two data stations when no active sessions are established between the stations. The control character is D.

**digital data network.** A communication network that uses digital transmission (that is, information is transmitted in digital form as a serial stream of pulses).

**direct call request.** A request that allows an operator to establish communication on an X.21 switched network without entering the network address of the host system. The network subscription must specify direct call request.

**display screen.** The presentation surface of a cathode ray tube used to display graphics or alphanumeric information.

**display station.** An input/output device containing a display screen and an attached keyboard.

**display station operator.** A person who uses the keyboard to do operations at a display station.

**duplex.** A method of data transmission in which the data can be transmitted in both directions simultaneously.

**emulation.** The imitation of all or part of one system by another, so that the imitating system accepts the same data, runs the same programs, and achieves the same results as the imitated system.

**enhanced logical link control.** A type of logical link control used in X.25 communication.

**external modem.** A modem that is not integrated into the DTE.

**exclusion key.** A key that, if present on the telephone, is located under the handset and is used to establish data communication.

**facility registration.** Allows an operator to change subscription parameters on an X.21 switched network (for example, the closed user group or redirection of calls).

**facility request code.** A one- or two-digit number representing a subscription parameter.

**fan-in/out modem.** A modem that uses a point-to-point line to attach multiple control units to the host system. Each control unit operates as if it were part of a multi-point line and processes only the data addressed to it.

**field.** One or more consecutive positions on the display screen set up for a specified type of data.

**flow control negotiation.** The ability to alter packet size and packet window size. These can be changed from call to call if the network subscription allows flow control negotiation.

**formatted display.** A display screen with fields established for specific information. The mode that the display station is in while signed on to the system.

**frame.** A single transmission of variable length (32-bit minimum format) that SDLC uses for transmission of data over a communication network.

**free key mode.** An operating mode that allows displaying of data without control by a system program (unformatted). The mode that the display station is in before logon to the system.

**half-duplex.** A method of data transmission in which data can be transmitted in both directions, but not at the same time.

**hexadecimal.** Pertains to a numbering system with a base of 16. Valid digits range from 0 through F, where F represents the highest units position, which is equivalent to decimal 15.

**home position.** The first input position of the first input field.

**host system.** In a data communication system, the computer that provides end users with services such as computation and data bases, and that usually does network control functions.

**image.** The characters or attributes displayed on a display screen.

**incoming calls barred.** A facility that prevents all incoming calls to a DTE on all logical channels for a period of time.

**input field.** An area on the display in which an operator enters data. Input fields may be blank on the display and can be preceded by a request, issued by a program, that requires information or an action from the operator.

**interface.** A shared boundary between two functional units, defined by functional characters, common physical interconnections, and signal characteristics.

**interface adapter.** A device that connects two machines with different physical characteristics.

**International Telegraph and Telephone Consultative Committee (CCITT).** This committee is an organization of common carriers and other interested parties who meet periodically to define standards that they will mutually adopt.

**leading pad.** A byte inserted into the data stream to synchronize the modem.

**link window size.** The maximum number of I-frames that can be sent from the control unit without receiving an acknowledgment from the network. Valid values are 1 through 7.

**local loopback.** A test procedure done to verify the operation of the modem attached to the IBM 5394.

**local network address.** The network address of the control unit. Some networks require this to be sent with the host network address on a call from the control unit to the host system.

**logical channel.** In packet mode operation, one logical channel is used for each PVC or SVC. Several logical channels can be established on the same data link by interleaving the transmission of packets.

**logical channel identifier.** A 12-bit number used to identify a logical channel. It consists of a 4-bit logical channel group number and an 8-bit logical channel number. The control character is L. The default value is 001.

**logical link control.** Information included in data packets for X.25 that provides end-to-end link-level type functions to the SNA layers in the host system and the IBM 5394.

**manual options.** Options that allow the display station operator to change call parameters from one call to the next.

**modem (modulator-demodulator).** A device that converts digital data from a computer to an analog signal that can be transmitted on a telecommunication line, and converts the analog signal received to data for the computer.

**network address.** The number that the network uses to identify a DTE. The display station operator must key in a host network address in order to initiate a call to a host system. The control character is N.

**Network Interface Adapter (NIA).** An IBM custom product (5973-L02) that allows SNA machines to communicate through X.25 networks.

**nonreturn to zero (NRZ).** A data encoding method.

**nonreturn to zero inverted (NRZI).** A data encoding method.

**nonswitched line.** A communication line that is permanently connected, always available, and does not require dialing to establish communication.

**null.** The EBCDIC character that represents X'00'.

**offline.** Pertains to the control unit when it is not communicating with the host system.

**online.** Pertains to the control unit when it is communicating with the host system.

**open command.** A command that is entered from a display station keyboard, and when processed, establishes a permanent virtual circuit (PVC) between two data stations. The control character is alphabetic O.

**outgoing calls barred.** A facility that prevents all outgoing calls from a DTE on all logical channels for a period of time.

**packet.** Information transmitted through a packet-switched network is divided up and inserted into packets. These usually consist of control information fields giving destination, sequence number, optional facilities, and often a user data area. Various kinds of packets are used to transmit system reference codes and supervise the virtual circuit.

**packet size.** The maximum number of bytes allowed in the user data area of a data packet. A default value, usually 128 bytes, is assigned at subscription time. On some networks, the packet size can be altered from call to call. The control character is P.

**packet-switched.** The transfer of data by means of address packets that occupy the network channel only during actual transmission. The channel is available for the simultaneous transfer of packets belonging to other network users.

**packet window size.** The maximum number of packets that can be sent without receiving an acknowledgment. The control character is W.

**password.** This parameter is used by the host system to allow access to the application program. The control character is X. The length of the variable can be from 1 through 8 characters.

**permanent virtual circuit (PVC).** The packet-switched equivalent of a leased line. The IBM 5394 and its host system appear to the user to be permanently connected.

**physical services header (PSH).** A type of logical link protocol used in X.25 communication.

**point-to-point line.** A data link that interconnects two DTEs. It can be either switched or nonswitched.

**port.** The hardware coupling used to attach the work stations to the control unit.

**Post Telegraph Telephone (PTT).** A name used to describe a government operating agency that controls the transportation of information (postal, voice, or data) within that country.

**power cord.** A cord that plugs into a wall outlet supplying electrical power.

**printer.** A device that provides printed output.

**program.** A sequence of instructions suitable for processing by a computer.

**protocol.** A set of instructions, requests, and responses providing the means of controlling the transfer of data between devices.

**public switched network (PSN).** A communication facility owned by a telephone company through which subscribers can be connected by dialing the unique telephone number of another subscriber.

**qualified logical link control.** A type of logical link control used in X.25 communication.

**Recognized Private Operating Agency (RPOA).** A CCITT term for organizations that provide network services.

**Recommendation V.25 bis.** A recommendation for interfaces set by the CCITT and amended periodically. V series defines standards for interfaces and voice board modem. V.25 bis defines automatic calling/answering for the general switched telephone network using the 100-series interchange circuits.

**Recommendation V.35.** A recommendation for interfaces set by the CCITT and amended periodically. V.35 defines a communication interface composed of five single-ended interchange lines and separate differential lines for transmit data, transmit clock, receive data, and receive clock signals.

**Recommendation X.21.** A recommendation for interfaces set by the CCITT and amended periodically. The X series of recommendations defines standards for data transmission interfaces. X.21, specifically, defines the interface between data terminal equipment and public data networks for digital leased and circuit-switched synchronous services.

**Recommendation X.25.** A recommendation for interfaces set by the CCITT and amended periodically. The X series of recommendations defines standards for data transmission interfaces. X.25, specifically, defines the interface between data terminal equipment and packet-switched networks.

**redirection of call.** On an X.21 switched network, this optional parameter allows an operator to specify if incoming calls should be directed to another number.

**remote attachment.** Attachment of work stations to the host system through communication lines, and usually through an intermediate control unit.

**remote loopback.** A test procedure done to verify the operation of the local modem, remote modem, and the communication lines between them.

**remote work station.** A work station that is attached to the host system through communication lines.

**reverse charging acceptance.** A facility that allows the network to pass reversed-charge calls to the DTE.

**reversed charging.** A facility that allows virtual calls to be billed to the DTE receiving the calls. The control character is R. There is no variable associated with the control character.

**short hold mode (SHM).** An X.21 switched communication option that allows a link between two stations to remain established only when there is data to transfer. The IBM 5394 supports, but does not initiate, an SHM session. The host system determines and controls SHM sessions.

**station protector.** A device used on the system cable to offer protection against lightning for attachments made in different buildings.

**subscription.** An agreement between a user and a PTT/network supplier for the use of certain network services and optional facilities.

**switched line.** A connection between computers or devices that is established by dialing.

**switched network backup (SNBU).** An optional facility that allows a user to specify a switched line to be used as an alternate path if the primary line becomes unavailable or unusable.

**switched virtual circuit (SVC).** The packet-switched service equivalent of a switched line. It allows communication between the IBM 5394 and one of several possible hosts. Switched virtual circuits are also known as virtual calls.

**synchronous data link control (SDLC).** A communication mode for managing synchronous, code-transparent, serial-by-bit information transfer over a data communication channel or line. Transmission exchanges may be duplex or half-duplex, over switched or nonswitched lines. The configuration of the communication line may be point-to-point, multipoint, or loop.

**system configuration.** A process that determines the devices, programs, and methods that form a data processing system.

**system operator.** A person who uses a display station that is designated as the system console, to activate certain system functions, and to control and monitor system operation.

**system reference code.** A four- or six- digit alphanumeric code that identifies a failure or status condition.

**systems network architecture (SNA).** A set of rules for controlling the transfer of information in a data communication network.

**telecommunication.** The transmission of data between locations by telephone line, telegraph, radio, satellite system, television, or microwave media.

**terminal multiconnector.** A device used to connect up to seven work stations to a single port on the IBM 5394. The IBM 5299 Terminal Multiconnector can be used when cable-thru is inappropriate or unavailable.

**terminator switch.** A switch used to terminate the system cable on the last work station when cable-thru is used and to provide a feed-thru path for other stations on the cable-thru line.

**test mode indication.** A signal generated by the modem that indicates that the modem is in a test mode, doing a self-test, a remotely requested test, or locally requested test.

**throughput class negotiation.** The throughput class is the approximate data transmission rate through the virtual circuit under ordinary conditions. (Network congestion could reduce this rate.) Unlike the link access data rate, which is a permanent property of the network connection, the throughput class can be altered by the display station operator if the network subscription allows. The subscription charge may increase with the throughput class selected. Note that choosing a different throughput class may also involve altering packet and window sizes.

**twinaxial cable.** A shielded cable with two conductors. It is used to pass information between devices separated by up to 1524 m (5000 ft). Compare with *twisted-pair cable*.

**twisted-pair cable.** An unshielded cable with two or more pairs of insulated copper wire twisted together at a minimum of two twists per foot. This type of cable is commonly used in telephone installations for voice transmission. It can also be used for data transmission. However, twisted-pair cable is subject to interference and line loss, and therefore is limited to lengths of 365.8 meters (1200 feet) when used to interconnect work stations attached to the IBM 5394.

**typematic keys.** Keyboard keys that repeat their function when pressed and held down.

**unformatted display.** See *free key mode*.

**unit address.** The address used to define each remote work station. This address must be obtained from the host system operator.

**V.25 bis.** See *Recommendation V.25 bis*.

**V.35.** See *Recommendation V.35*.

**X.21.** See *Recommendation X.21*.

**X.25.** See *Recommendation X.25*.

**virtual call.** A call placed on a switched virtual circuit.

**virtual circuit.** A logical connection between two DTEs that enables them to exchange information according to a standard communication procedure with the sequence of information preserved. A virtual circuit occupies transmission capacity only when the data is actually being transmitted.

**window size.** The maximum number of packets that the DTE is authorized to transmit and have outstanding at any given time. It is the basic flow control mechanism in X.25 and protects the network from accepting packets faster than they can be accepted by the remote DTE. The window can also be used by a DTE to prevent transmission of packets from the network if the DTE is unable or unwilling to queue them. A default window size, usually 2, is assigned at subscription time. On some networks, this can be altered for a given virtual call.

**work station.** An input or output device that allows either the transmission of data or the reception of data (or both) from a host system, as needed to do a job (for example, a display station or printer).

**work station address.** The address set by the operator during setup of the work station. This address can be set on rocker switches, by keyboard entry, or by control panel entry.

**World Trade.** Any of the countries in Europe, Asia, Africa, and South America served by IBM.



# Index

## A

- AC power indicator 22
- adding work stations 52
- applications worksheet 70, 71
  - copy of 149
  - preparing 127
    - X.21 switched communication 137
    - X.25 communication 130

## B

- bidirectional support SRCs 167

## C

- cables
  - connecting to work stations 18
  - labeling 15
- call progress signals 51, 126
- check disk indicator 20
- codes, system reference 153
- com line sync indicator 20
- communication line, connecting 59
- communication network SRCs
  - general 161
  - X.21 switched 188
  - X.25 175
- communication procedures
  - detaching communication 74
  - determining your mode 151
  - ending communication 74
  - establishing communication 65, 70
    - SDLC mode 65
    - X.21 switched mode 71
    - X.25 communication mode 70
    - X.25 mode 70
  - introduction 63
- communication tests 97
- configuring the system
  - adding work stations 52
  - at a central site 31
  - SDLC communication 40
  - starting 32
  - without all work stations attached 31
  - X.21 switched communication 50
  - X.25 communication 44
- Control unit setup 22
- conversion, decimal-to-hexadecimal 205
- copy-to-printer SRCs 195
- copying configuration information 55
- country codes 13
- customer setup SRCs 169

## D

- DETACH command 74
- devices, supported 4
- diagnostic codes
  - ISO (1984) 123
  - SNA (1980) 123
  - SNA (1984) 123
- diskette activity indicator 21
- diskette drive SRCs 194
- diskette SRCs 194
- diskettes, ordering replacement 207

## E

- EIA 232D extended test routine 99
- ending communication 74
- establishing communication 63
- extended test routine
  - EIA 232D 99
  - V.35 107
  - X.21 switched. 99

## F

- flowchart (PDPs) 91

## H

- hexadecimal conversion 205
- host support SRCs 170

## I

- IBM 5299 Terminal Multiconnector
  - configuration 13
- IBM 5394 Remote Control Unit
  - introduction 1
  - moving 75
  - operator panel 19
  - operator panel indicators 20
  - repackaging 75
  - Setup 22
  - storing 75
  - switches 19
- ideographic support SRCs 166
- indicators
  - AC power 22
  - check disk 20
  - com line sync 20
  - disk activity 21
  - power 21
  - ready 20
  - work station active 20



ISO format diagnostic codes 123

## K

key sequences

system request 197

test request 197

keyboard codes 14

keyboards

IBM Enhanced (102-key) keyboard 201

IBM PC AT keyboard 203

IBM PC, PC XT, and Portable PC keyboard 202

IBM Personal System/2 keyboard 204

IBM Typewriter Data Entry keyboard 199

IBM Typewriter keyboard 198

IBM 122-key keyboard 200

## L

labels, cable 15

local copy key sequence 197

loopback

analog loopback 103

local loopback 103

remote loopback 104

## M

menu, prime option 97

microcode change SRCs 195

modems, supported 4

moving the IBM 5394 75

## O

operator panel

indicators 20

switches 19

operator panel indicators 20

check disk 20

com line sync 20

power 21

ready 20

work station active 20

operator SRCs 156

general 156

X.21 switched only 187

X.25 only 171

## P

power indicator 21

power switch 19

power-on sequence SRCs 196

prime option menu 97

Print, key sequence 197

problem checklist 57

problem determination procedures 77

PVC

establishing X.25 communication with 130

example 131

## R

ready indicator 20

Remote Work Station Setup Worksheet 9

repackaging the IBM 5394 75

replacing failing diskettes 207

## S

saving configuration data

SDLC 43

X.21 switched 52

X.25 49

screen symbols 57

SDLC communication mode

establishing communication with host 151

nonswitched communication line 65

switched communication line 66

autoanswering 66

dialing 66

manual answering 66

SDLC communication worksheet

completing 117

SDLC, saving configuration 43

setting up the 5394 22

setting up work stations

floor plan 9

necessary equipment 7

SNA format diagnostic codes 123

storing the IBM 5394 75

subscription parameters, changing 73

SVC answer

establishing X.25 communication with 132

example 133

SVC call

establishing X.25 communication with 134

example 136

switches

power 19

test 20

system available indicator 77

system diskettes, replacing 207

system reference codes

bidirectional support errors 167

communication network errors

general 161

X.21 switched only 188

X.25 only 175

copy-to-printer 195

customer setup errors 169

diskette drive errors 194

diskette errors 194

host support errors 170

ideographic support errors 166

system reference codes (*continued*)  
microcode change errors 195  
operator errors  
  general 156  
  X.21 switched only 187  
  X.25 only 171  
power-on sequence errors 196  
table 153  
text entry assist 168  
V.25 bis call indication 193  
V.25 bis circuit-terminating 193  
V.25 bis operator 192  
system request key sequence 197

## T

test number 101, 109  
test request key sequence 197  
test switch 20  
text entry assist SRCs 168  
twiaxial cabling  
  labeling 15

## V

verification tests 97  
V.25 bis SRCs  
  call indication 193  
  circuit-terminating 193  
  operator 192  
V.35 extended test routine 107

## W

work station active indicator 20  
work station setup 7  
work stations, supported 3  
worksheets  
  checklist 115  
  Remote Work Station Setup 9  
  example 11, 12  
  instructions for completing 13

## X

X.21 switched  
  answer 137  
  changing subscription parameters 137  
  establishing communication  
    address call 137  
    direct call 137  
  saving configuration 52  
X.21 switched communication mode  
  DETACH command 74  
  establishing communication with host 71  
  system reference codes  
    communication network errors 188  
    keyboard-entry errors 187

X.21 switched communication worksheet  
  completing 125  
X.21 switched extended test routine 99  
X.25  
  *See also* packet-switched network  
  establishing communication  
    PVC 130  
    SVC answer 132  
    SVC call 134  
  saving configuration 49  
X.25 communication mode  
  DETACH command 74  
  establishing communication with host 70  
  system reference codes 171  
    communication network errors 175  
    operator errors 171  
X.25 communication worksheet  
  completing 121







Cut or Fold  
Along Line

Fold and Tape

Please do not staple

Fold and Tape



NO POSTAGE  
NECESSARY  
IF MAILED IN THE  
UNITED STATES



# BUSINESS REPLY MAIL

FIRST CLASS MAIL PERMIT NO. 40 ARMONK, NEW YORK

POSTAGE WILL BE PAID BY ADDRESSEE

International Business Machines Corporation  
Information Development  
Department E02  
PO BOX 12195  
RESEARCH TRIANGLE PARK NC 27709-9990



Fold and Tape

Please do not staple

Fold and Tape

Cut or Fold  
Along Line













Part Number  
53F7965

File Number  
5394-09

GA27-3852-01



Printed in U.S.A.