



First Edition September 1971

Requests for copies of IBM publications should be made to your IBM representative or to the IBM branch office serving your locality. Address comments concerning the contents of this publication to IBM Corporation, DPD Education Development - Publications Services, Education Center, South Road, Poughkeepsie, New York 12602.

© Copyright International Business Machines Corporation 1971

TABLE OF CONTENTS

Section 1 INTRODUCTION	1
Section 2 COURSE DESCRIPTION	2
Section 3 GENERAL COURSE OUTLINE.....	3
Section 4 DETAILED COURSE OUTLINE	4
Section 5 INSTRUCTOR MATERIALS	5
Section 6 SOLUTIONS TO STUDENT EXERCISES.....	6



.

.



.

.



INTRODUCTION

This Education Guide consists of the following sections:

- Section 1 - Introduction
- Section 2 - Course Description
- Section 3 - General Course Outline
- Section 4 - Detail Course Outline
- Section 5 - Student Exercises
- Section 6 - Solutions to Student Exercises

Both outlines are in a suggested teaching sequence and indicate the daily topics and placement of student exercises and tests. In addition, the Detail Course Outline contains instruction notes, foil references, and foils.

This Education Guide is written for the instructor who is trained and qualified to teach the IBM 3270 Operation and Design Course. At the time this outline was prepared, there were a limited number of manuals available on the IBM 3270 operation; therefore, it is particularly important that the instructor who plans to teach this course attend an IBM 3270 Operation and Design Class.

Conduction

The IBM 3270 O&D Course consists of lecture interspersed with student exercises to reinforce the material. These student exercises are an important part of the class and without exception all students should perform all the exercises. Where possible the exercises should be presented at a time in the class where they coincide with a break. In this manner the break and performing of the exercise overlap to account for the differences in time it takes for various students to perform the exercises.

The student will be expected to read "An Introduction to the IBM 3270 Information Display System" (GA27-2739) However, it should be noted much of the information covered in this class is not contained in that manual. The instructor should also be careful that a student who has read the manual does not draw the instructor into a discussion of a subject before he is ready to cover it in class.

It must be emphasized that this class is not a programming class. The instructor must not become involved in any discussions which hypothesize as to the form of programming support. However, the instructor must realize that there will be students in every class looking for this type of information. Although the class is dealing with output and input data streams, the channel programs generated are not a concern of this class.

Student Exercises

The student exercises are contained in Section 5 of this guide for instructor reference and in Section 2 of the "IBM 3270 Student Materials". Section 2 should be removed from the student materials before handing them out at the start of the class. The exercises build on one another and, therefore, later exercises contain results of earlier exercises. Exercises should be handed out to the students as they are assigned.

Because of the systems design nature of the class exercises, there are several exercises which can have variations to the sample solutions. Where possible some of these differences are discussed in the solutions. The instructor must be qualified in order that he can recognize other acceptable variations of the solutions. Ideally, the instructor should examine every student's solution to each exercise. However, if time does not permit, as a very minimum, students should be selected to present their solutions to the class. Adequate time must then be provided for other class members to take exception to the solution and present their own solutions.

In allowing time for each exercise, the instructor must include time for presentation of the problem and discussion of the solution. The times provided in the outline for class exercises represent only approximate time that should be given for all students to complete working the exercise. Additional time will be required for reviewing the solutions.

Abbreviations for 3270 Class

In the process of teaching this class the instructor and student will encounter many new abbreviations. The following list of abbreviations and their meanings is provided for reference:

AID	Attention ID
ATT	Attribute Code
BPS	Bits Per Second
BSC	Binary Synchronous Communications
BTAM	Basic Teleprocessing Access Method
CBA	Current Buffer Address
CCC	Copy Control Character
CPS	Characters Per Second
CU	Control Unit
DIDOCs	Device Independent Display Operator Console Support
DS	Display Station
DUP	Duplicate order
EAU	Erase All Unprotected command
EM	End of Message order
EUA	Erase Unprotected to Address order
FM	Field Mark
IC	Insert Cursor order
K/B	Keyboard
MDT	Modified Data Tag
NL	New Line order
PA	Program Attention key
PF	Program Function key
PT	Program Tab order
RA	Repeat to Address order
SBA	Set Buffer Address order
SDS	Status Display Support
SF	Start Field order
WCC	Write Control Character
∅	Blank
∅	Null



.

.



.

.



COURSE DESCRIPTION

IBM 3270 OPERATION AND DESIGN

Course Code - G3687

Audience - Personnel performing the function of Systems Analysis, Applications Programming or Systems Programming.

Prerequisite - Given the appropriate reference materials, the student should be able to:

1. Match teleprocessing related terms to their definitions.
2. Select the data link control sequences required to perform a given teleprocessing application.
3. Select the BSC text framing characters necessary to transmit data.
4. Using the S/360 Reference Data Card convert between EBCDIC and hexadecimal.
5. Discriminate among bits, bytes, and words as used in the S/360 and S/370.
6. Select the correct channel command to cause a given teleprocessing function to be performed.

The above prerequisites may be learned in Communications System Design and Analysis (D3602) or Communications System Design for Programmers (G3600). The total content of these courses will provide more than the minimum prerequisite for attendance at this course.

Objectives -

Upon successful completion of this course, given appropriate reference materials, the student should be able to:

1. Select the combination of IBM 3270 Information Display System devices and features that will meet the input and output requirements for a given application at a particular location, either in a remote or local environment.
2. Specify the format and characteristics of information to be displayed at a display station or printer, or both, when given a specific application to be implemented.
3. Identify the fields, field delimiters, and control sequences comprising a message transmitted to or from the 3270 system, and describe the functions and effects of the control sequences and field delimiters when given the format and contents of a record.
4. Identify the limits of data fields within the record from the application program and correctly build messages for transmission to a 3270 system, either local or remote.
5. Identify the source of a message received from a 3270 system, either local or remote, and extract the text to be passed to the application program, if required by the application.
6. Select the appropriate command to cause a control-unit function of a 3270 system, either local or remote, to be executed as required by a given application.

7. Describe how to position the cursor of the 3275 or 3277 Display Station, and how to Determine its position when a message is received from the 3270 system.
8. List the variables which will describe the status of each device in the 3270 system to the teleprocessing access method programmer, when given the configuration of devices and control units in the system and the application requirements of the system.

Materials Required:

Student Material (one per student)

TITLE	FORM NO.
An Introduction to the IBM 3270 Information Display System.	GA27-2739
The IBM 3270 Information Display System.	G520-2446
General Information-Binary Synchronous Communications.	GA27-3004
IBM System/360 Reference Data.	GX20-1703
Student Materials	ZR20-4265

Instructor Material (in addition to above)

3270 Preliminary Installation Aids - TIE Paper	ZZ77-1056
Education Guide	ZR20-4264
IBM 3270 Information Display System - Slides	GV20-0283

Tests

A prerequisite and final test are available in the Standard Course Guidelines - see your Education Center Manager for the availability of this manual.

The abstracts for these publications can be found in BOIS.

GENERAL COURSE OUTLINE

DAY 1

Prerequisite Test (30 min.)

Review Test

TOPIC 1 - INTRODUCTION TO IBM 3270 INFORMATION DISPLAY SYSTEM.

A. IBM 3270 System Features

1. Components

- a. Control Units
- b. Display Station
- c. Printer
- d. Operator ID card reader

2. Display Station features

- a. Human factors
- b. Size of screen
- c. Character addressable
- d. Field oriented
- e. Selector pen
- f. Keyboards
- g. Audible alarm
- h. Speed of data transfer
- i. Hard copy
- j. Security
- k. Indicator lights

3. Uses

- a. Terminal
- b. System operator's console

B. Local Hardware Configuration

1. IBM 3272 Control Unit general information
 - a. Attaches to selector, multiplexer, or block multiplexer channel.
 - b. Speeds up to 650,000 cps.
 - c. CU up to 200 feet from channel.
2. IBM 3272 Control Unit
 - a. Functions
 - b. Models of CU
 - c. Models of DS - 3277
 - d. Models of printers - 3284 and 3286.

C. Remote Hardware Considerations

1. Control Unit - 3271 general information.
 - a. Attaches to S/360 or S/370 via communication line.
2. 3271 Control Unit
 - a. Functions
3. 3275 Stand-alone Unit
 - a. Attaches on multipoint BSC line
 - b. CU and DS contained in single unit.
 - c. Models of stand-alone DS
 - d. Printer - 3284 Model 3

Class Exercise 1 - Configuration (30 min.)

TOPIC 2 - REMOTE OPERATION

A. BSC Multipoint Data Link Control for 3270.

1. Features

- a. Supports multiple BSC devices on line.
- b. Line operates in EBCDIC or ASCII.
- c. Improved checking on transmission.

2. BSC data link control review.

- a. Polling
- b. Selection

3. I/O operations controlled by BTAM

B. Data Stream Contents

1. Polling or selection sequence

2. Output data stream - general.

- a. BSC text framing characters
- b. Command sequence
- c. Set Buffer Address (SBA) sequence.
- d. Start Field (SF) sequence

C. Example of Screen Format

1. Field oriented concept.

TOPIC 3 - CREATING SCREEN FORMAT AND BUILDING OUTPUT
DATA STREAM FOR REMOTE 3270.

A. Components of Data Stream.

1. General contents
 - a. Commands
 - b. Orders
 - c. Control characters
 - d. Text
2. Start Field sequence
 - a. Start Field (SF) order
 - b. Attribute (ATT) code
3. Set Buffer Address (SBA) sequence
 - a. SBA order
 - b. Address
 - c. Occurance
4. Command Sequence
 - a. ESC
 - b. Commands
 - c. Write Control Character (WCC)

Class Exercise 2 - Building output data stream (20 min.)

DAY 2

B. IBM 3270 Output Data Stream Continued.

1. Additional orders
 - a. Insert Cursor (IC)
 - b. Repeat to Address (RA)
2. Selector pen detectable fields
 - a. Optional feature
 - b. Entry of data without keyboard operation.
 - c. Attribute code indicates field selectable.
 - d. On detection Modified Data Tag (MDT) set.
 - e. Field format

Class Exercise 3 - Expansion of output data stream.
(30 min.)

TOPIC 4 - INPUT DATA STREAM FROM REMOTE 3270.

A. Types of Reads

1. Read Modified
 - a. Read only fields with MDT set.
 - b. If unformatted buffer, read entire buffer.
 - c. Short read

B. Components of Data Stream for Read Modified.

1. General contents of data stream.
2. Source of message
 - a. CU and Device address.
 - b. Specific poll vs. general poll.
3. Attention ID (AID) character
 - a. Operator request for service.
 - b. AID identifies cause of request.
 - c. I/O pending set at device.
 - d. Resetting of AID
4. Cursor address
5. Field data

C. Erasing Under Program Control.

1. Erase/Write command.
2. Erase All Unprotected command.
 - a. Functions
 - b. Data stream
3. Erase Unprotected to Address (EUA) order.
 - a. Include in write data stream.
 - b. Operation
 - c. Use

D. Additional Read Command Considerations.

1. Read Modified command - short read.
2. Read Buffer command.
 - a. Entire buffer transferred.
 - b. Used primarily for debugging.

Class Exercise 4 - Input data stream and erasing of
screen (45 min.)

DAY 3

TOPIC 5 - LOCAL OPERATION

A. Output Data Stream

1. Channel commands

- a. Effect of CBA
- b. ERASE/WRITE channel command
- c. WRITE channel command
- d. ERASE ALL UNPROTECTED channel command

B. Input Data Stream

1. Channel commands

- a. Read channel commands
- b. SELECT channel command

C. WCC, Orders, Attribute Code, AID

Class Exercise 5 - Local data streams (10 min.)

TOPIC 6 - PRINTER OPERATIONS

A. Hardware Considerations

1. IBM 3284 or 3286 Printer with 3271 or 3272 CU.
2. IBM 3284 Model 3 with 3275 DS.
3. Print positions - 120, 126, or 132 characters per line.

B. Uses for Printer

1. Hard copy of displayed information.
 - a. Processor to printer
 - b. DS to printer
2. Hard copy formatted for printer

C. Output to Printer When Same as DS.

1. General data stream.
2. Command sequence
3. SBA sequence
4. SF sequence
5. Other orders and text

D. Output Formatted Specifically for Remote Printer.

1. Program specifically for hard copy.
2. WCC - printer specifications (NL & EM)
3. SBA sequence

E. Copy DS to Printer or DS to DS.

1. General information - remote cluster only.
2. Output data stream to perform copy
 - a. Select device to receive with BSC selection
 - b. Write data stream to initiate copy
 - c. Copy DS to DS

F. Output to Local Printer

1. Differences between remote and local.
2. Output data stream to local.

TOPIC 7 - ADDITIONAL FUNCTIONS AND FEATURES OF THE
3270 SYSTEM.

A. Additional Orders

1. Program Tab (PT)
2. Duplicate (DUP)
3. Field Mark (FM)

B. Operator Identification Card Reader

1. Enters user information.
2. Physical characteristics of ID card.

TOPIC 8 - PROGRAMMING SUPPORT OVERVIEW, MAINTAINING
STATUS, AND SCREEN DESIGN.

- A. IBM 3270 System as a Terminal.
 - 1. OS and DOS BTAM
- B. IBM 3270 System as a Display Operator Console.
 - 1. DIDOCS - Device Independent Display Operator Console Support.
 - 2. SDS - Status Display Support.
- C. Determining What Status Information Must Be Maintained For Each Display Station and Printer.

Class Exercise 7 - Determining status information
(15 min.)

D. Screen Design

Class Exercise 8 - Screen design (30 min.)

FINAL TEST (30 min.)

PREQUISITE TEST

REVIEW TEST

NOTE: Based on the results of the prerequisite test, it may be necessary to review BSC and particularly Multipoint Data Link Control.

TOPIC 1 - INTRODUCTION TO IBM 3270 INFORMATION DISPLAY SYSTEM.

A. IBM 3270 System Features

NOTE: It is suggested IBM 3270 Information Display System (GV20-0283) slides be shown at this point. With the use of these slides, the instructor can skip portions of Section A.

1. Components (1-V-1)

a. Control Units (CU)

- 1) Remote - BSC
- 2) Local

b. Display Station (DS)

CRT
Keyboards

c. Printer

Two speeds to select from - 40 CPS
& 66 CPS

d. Operator identification card reader attaches to DS.

2. Display Station Features (1-V-2)

a. Human factors

1) Clarity of image

a) Anti-glare design

High contrast screen

b) 7X9 dot matrix

c) Brightness is operator adjustable

- 2) No air conditioning required
 - 3) Light and small
Control unit size of 2 drawer file cabinet.
 - 4) K/B key clicks when character successfully entered.
- b. Size of screen
- 1) 480 - Model 1 (1-V-3)
12 lines of 40 characters
 - 2) 1920 - Model 2 (1-V-2)
24 lines of 80 characters
- c. Character addressable
- 1) Every character addressable
 - 2) Program controlled arrangement of data on screen by selective writes to various noncontiguous areas on the screen.
 - 3) Permits changing of selected fields
- d. Field oriented
- 1) Each data field specified by field attribute control code in first position of field.
 - 2) Functions of attribute code
 - a) Protected or unprotected
Permits operator to enter only variable data.
 - b) Brightness
Off/normal/bright
 - c) Alphameric or numeric input
 - d) Selector pen detectable

e. Selector pen

1) Special feature

- 2) Select fields for input with use of pen for speed and accuracy.

Reduces keystrokes and simplifies operations.

f. Keyboards

NOTE: Three basic keyboards are shown in Chapter 2 of GA27-2739.

1) Several keyboard layouts depending on application -

- a) Typewriter - 66 or 78 character (1-V-4)

Either US ASCII or US EBCDIC

- b) Data Entry - 66 character (1-V-5)

- c) Operator Console - 66 or 78 character

2) Keyboard operations

NOTE: Use foils 1-V-5 or 1-V-6 to show cursor movement and keyboard functions.

NOTE: There will always be a cursor on the screen, e.g., power on places the cursor in the upper left hand corner of the screen.

Cursor can be displayed under any position on the screen and does not destroy data as it is moved. It can be moved under both operator and program control.

a) Cursor movement keys

UP (↑)

DOWN (↓)

LEFT or BACKSPACE (←)

RIGHT (→)

TAB or SKIP (→|)

BACKTAB (←|)

NEW LINE (↵)

All typamatic except BACKTAB
All keys will wrap

NOTE: TAB, SKIP (Data entry keyboard), and BACKTAB are all field oriented keys. TAB and SKIP will cause cursor movement to the first position of the next unprotected field as defined by the attribute code. BACKTAB will cause cursor movement to the first position of the previously defined unprotected field.

NOTE: Any erase function clears the buffer or portions of the buffer to null characters. A null is a distinct character and will permit functions to be performed that are not possible with blank characters in the buffer. The differences will be discussed throughout the course.

b) Erasing keys

ERASE EOF

Clears to nulls from cursor position to end of field in which cursor is located.
Does not move cursor.

ERASE INPUT

Clears all unprotected characters to nulls.
Position cursor in first position of first unprotected field.

CLEAR

Clears entire buffer to nulls.
Cursor positioned at location 0.

c) Edit keys

Insert mode (INS MODE key)
Delete (DEL key)

NOTE: To use insert mode must have nulls in the field being modified to permit addition of new data. If at end of line or field and no nulls left for insertion, K/B locks. Operator leaves insert mode or resets K/B when locked by depressing reset key.

Delete causes removal of character, compression of data in the field, and addition of nulls at the end of the field.

- d) Program function and program attention keys.

Depression of any of these keys permit uniquely coded input to application program.

NOTE: PF and PA keys will be discussed in greater detail when considering content of input data streams.

- e) Reset key

Enables operator to recover from a locked keyboard, e.g., after attempting to key data into a protected field.

- f) Enter key

One of the keys used to request servicing of the terminal after the operator has entered data.

NOTE: See Chapter 3 of GA27-2739 for further description of keyboard functions. Certain other keys, e.g., DUP and FIELD MARK, will be discussed when covering input data streams.

- 3) Movable

2 1/2 feet of cable

Keyboards can be interchanged for different applications.

Can remove keyboard and lock it up for security.

- g. Audible alarm

- 1) Special feature

- 2) Obtains operator's attention

Duration 3 seconds

Volume operator adjustable

- h. Speed of data transfer.

- 1) Speed of CRT

- 2) Speed of data transfer

3) Techniques to reduce volume of data transfer.

i. Hard copy

Two models of printers

j. Security

1) Lock

Special feature

2) Non-display feature

Permits operator to key security code without being displayed.

3) Operator identification via an operator ID card reader.

k. Indicator lights

1) Located on right hand side of screen

2) Three lights

a) Insert mode

Turned on by depression of insert key when operator wants to go into insert mode.

b) Input inhibited

Manual input or selector pen input inhibited.

c) System available

Successful completion with CPU. Ready for another operation.

3. Uses

a. As a terminal

1) Data entry

2) Inquiry

NOTE: Data entry and inquiry applications include many different types. Reference Chapter 4 of GA27-2739 for types.

- b. System operator's console
 - 1) Display operator console
Includes keyboard
 - 2) Output only display console
Keyboard not necessary

B. Local Hardware Configuration

(1-V-7)

- 1. IBM 3272 Control Unit general information
 - a. Attaches to selector, multiplexer, or block multiplexer channel.
 - b. Speeds up to 650,000 character per second.
 - c. CU can be up to 200 feet from channel.

Distance from channel has same limits as other types of control units on S/360 or S/370.

NOTE: Speed varies depending on model of S/360 or S/370. When significant volumes of data being transferred, block multiplexer channel would be preferred if system has one.

2. 3272 Control Unit

a. Functions

- 1) Interfaces with channel. (1-V-8)
- 2) Interprets and performs operations specified by:

Channel commands
Data stream
- 3) Buffers I/O to and from DS's and printer buffers.
- 4) Interfaces with displays and printers.

Up to 32 of them.
Must have at least 1 DS.
Can have 0 printers.

b. Models of CU

(1-V-9)

- 1) Model 1

- a) 480 character buffer
 - b) Can have only DS and printers with 480 character buffers connected to it.
- 2) Model 2
- a) 1920 character buffer
 - b) Can have any size DS or printer connected to it.
- c. Models of DS - 3277
- 1) Model 1
- a) 480 character display image
 - b) Contains 480 character regenerative buffer.
 - c) Keyboards
 - None
 - Typewriter
 - Data entry
 - Operator console keyboard

NOTE: All keyboards can have variations. See Chapter 2 of GA27-2739 and sales manual pages. Do not get involved with a detailed discussion of keyboards.

- 2) Model 2
- a) 1920 character display image
 - b) Contains 1920 regen buffer

NOTE: Keyboards for Model 2 same as for Model 1.

NOTE: Actual screen size varies between Model 1 and 2. See 1-V-2 and 1-V-3.

- d. Models of printers - 3284 and 3286
- 1) 3284 - 40 CPS print rate
- a) Model 1
 - 480 character buffer
 - Attaches only to Model 2 of 3272.

b) Model 2

1920 character buffer
Attaches only to model 2 of 3272

NOTE: There is a Model 3 for the 3284 but only for remote stand-alone. Do not discuss at this point.

2) 3286 - 66 CPS print rate

a) Model 1

480 character buffer
Attaches to 3272 Model 1 or 2

b) Model 2

1920 character buffer
Attaches to only Model 2 of 3272

NOTE: The DS's and printers attached to the 3271 and 3272 CU units can be up to 2000' away from the CU. If the user has 2260 cables, they can be used for installation. The only cable required for this installation is a single coaxial cable. The cable is limited to 2000' because of signal distortion above that distance.

C. Remote Hardware Considerations

1. Control Unit - (3271) general information

(1-V-10)

a. Attaches to S/360 or S/370 via communications line.

1) Data set at CPU attaches to:

a) TCU-2701 or 2703

b) Integrated Communications Adapter (ICA)

S/370 Model 135 only.

NOTE: TCU will normally be attached to multiplexer channel. The 2701 can be attached to block multiplexer channel on Model 135 and selector channels on other S/360 and S/370's. The 2703 can be connected only to multiplexer channel.

- 2) Communications line speeds - leased line.
1200 bps
2000 bps
2400 bps
4800 bps
- 3) Binary synchronous multipoint data link control.

NOTE: Even if only one remote CU on line it will be multipoint line control.

- a) Up to 32 remote 3270 display systems.
- b) Can have 3270 system intermixed on same line with other BSC devices.
- c) BSC transmission code can be either EBCDIC or ASCII.

2. 3271 Control Unit

a. Functions

(1-V-11)

- 1) Interfaces with data set

NOTE: Since CU is remote it will not receive channel commands. All control unit commands and device orders will be in data stream. Data stream including commands and orders will be covered later.

NOTE: The strategy of the course is to emphasize remote terminal operations. Then cover the differences in local operations.

3. 3275 Stand-alone Unit

- a. Attaches remotely in the same manner as the 3271 multipoint on BSC line.
- b. CU and display station are contained in a single unit.
- c. Models of DS

- 1) Model 1

480 character display image and buffer

2) Model 2

1920 character display image and buffer.

d. Printer - Only 3284 Model 3

1) Attaches to 3275 Model 1 and 2

2) Shares buffer in 3275

3) Prints at 40 CPS

4) Printer up to 10 feet from display

NOTE: Appendix A and Appendix B of GA27-2739 are good references for the hardware configuration.

Class Exercise 1 - Configuration of a system (30 min.)



.

.



.

.



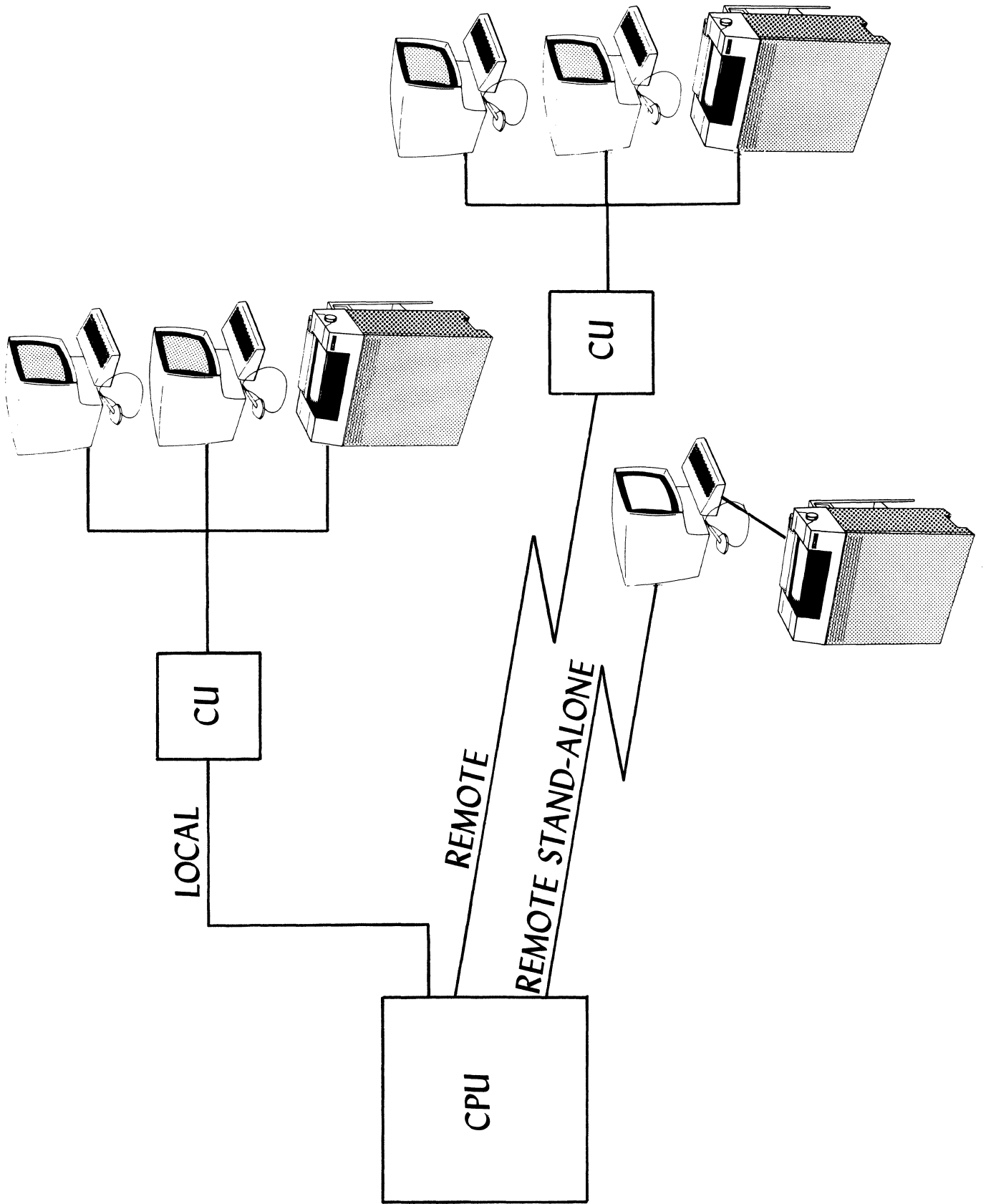

		NAME :											
		SALARY :											
		JOB TITLE :											
		PHONE # :											

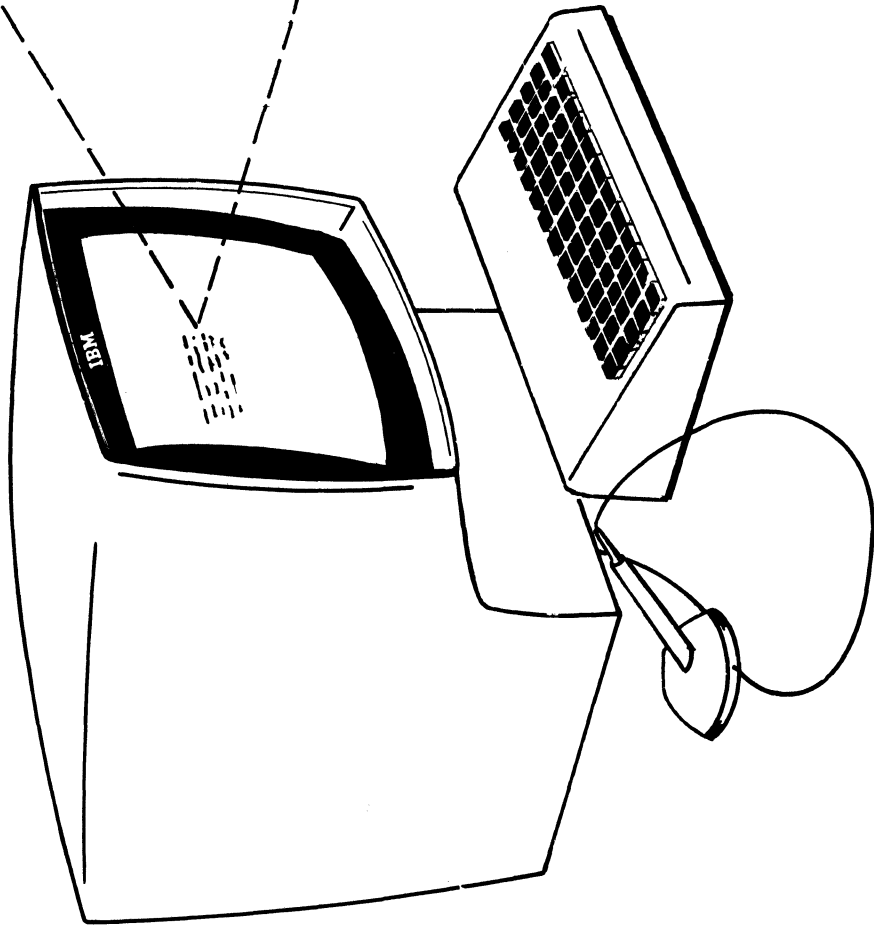
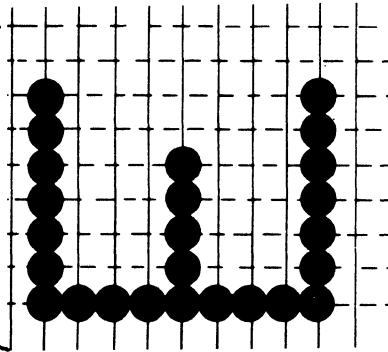

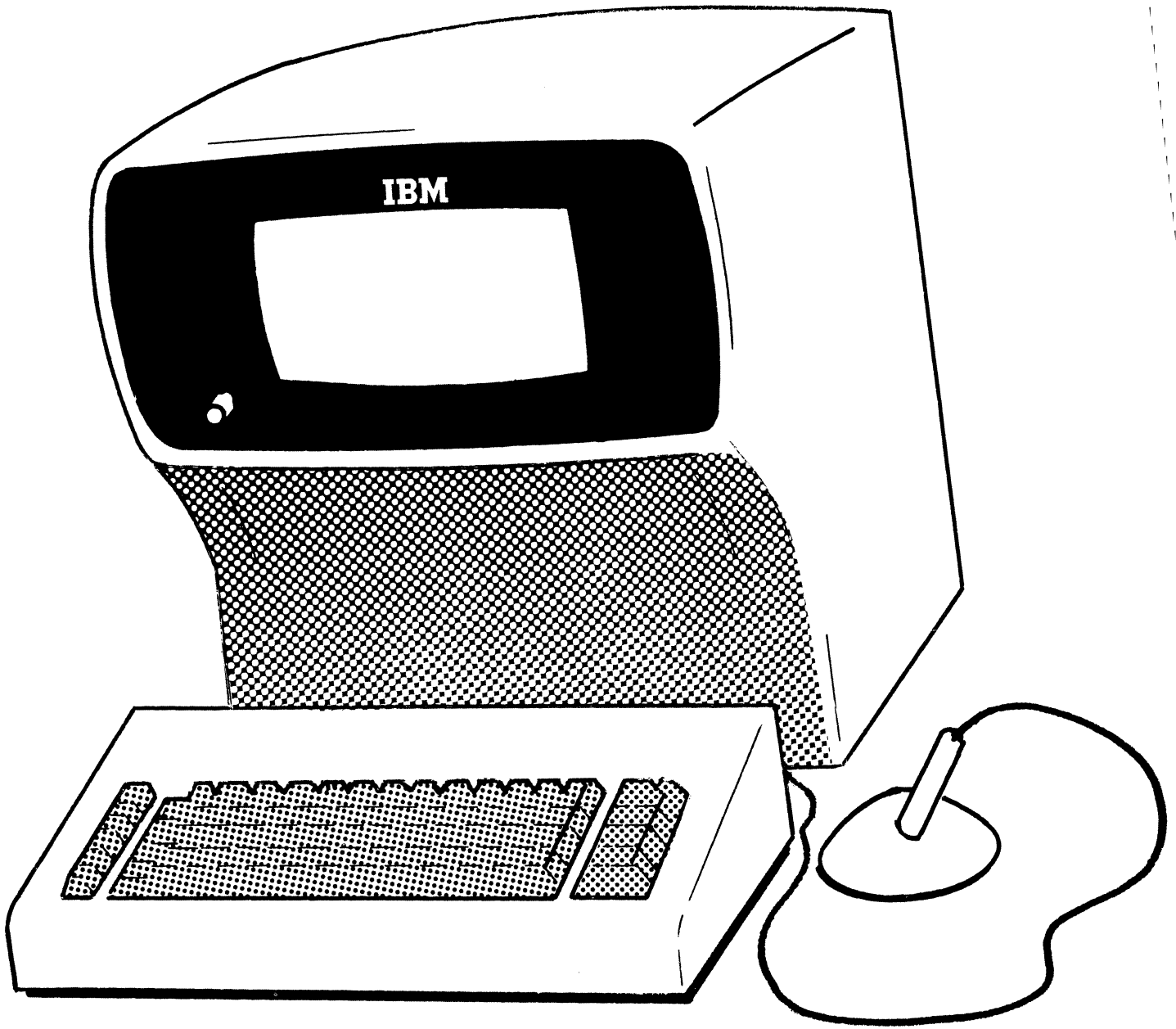

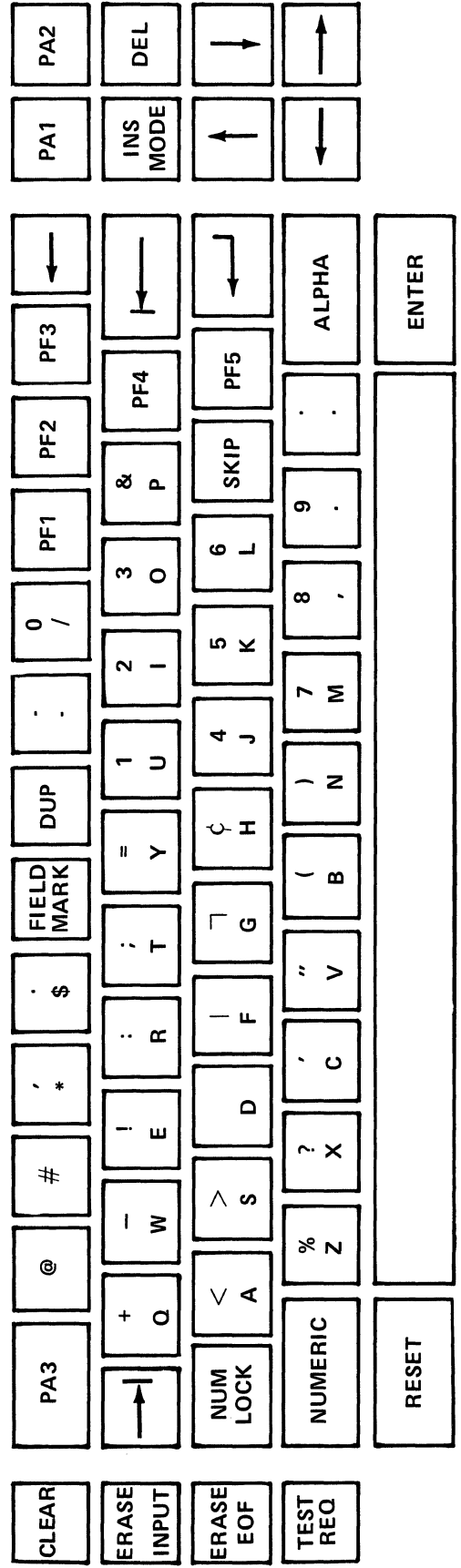
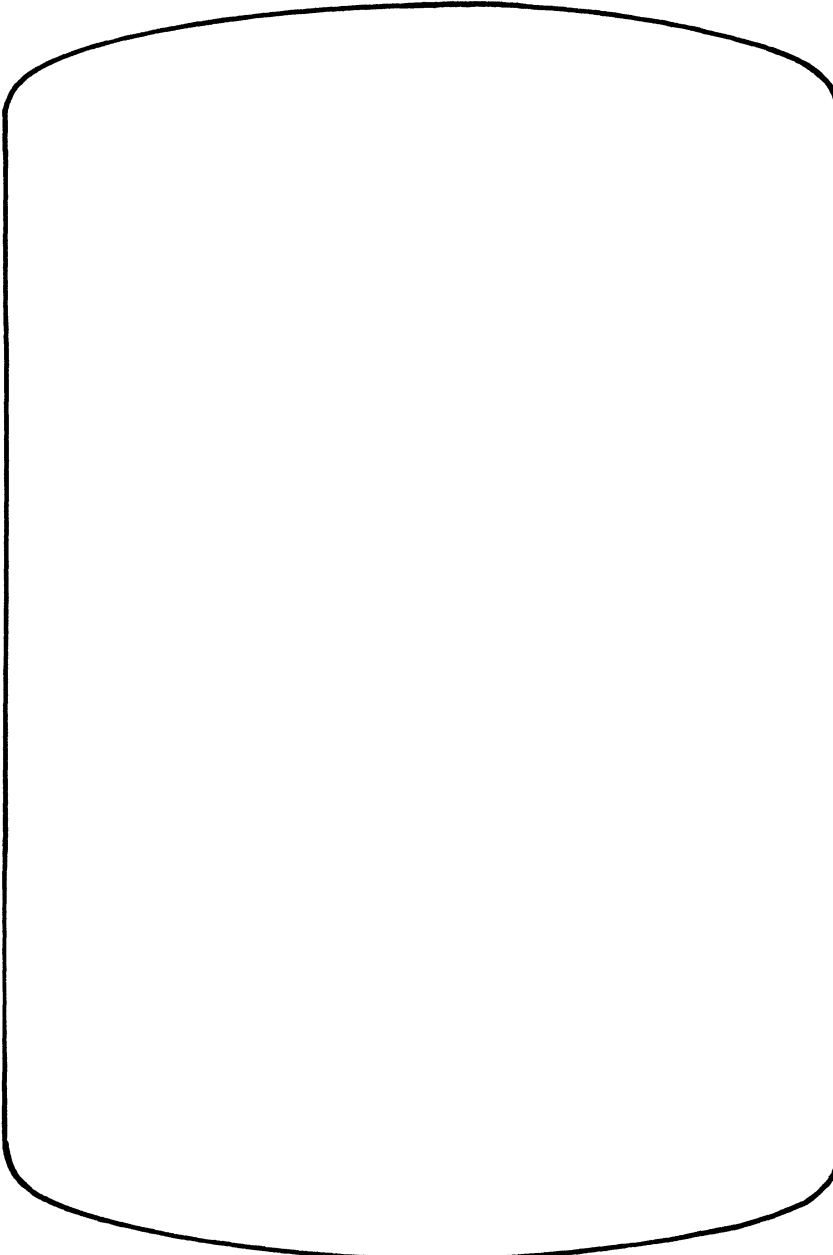

1-V-6

	0	1	2	3	4	5	6	7	8	9	10	11	12	13	14	15	16	17	18	19	20	21	22	23	24	25	26	27	28	29	30	31	32	33	34	35	36	37	38	39		
0																																										
40																																										
80																																										
120																																										
160																																										
200																																										
240																																										
280																																										
320																																										
360																																										
400																																										
440																																										

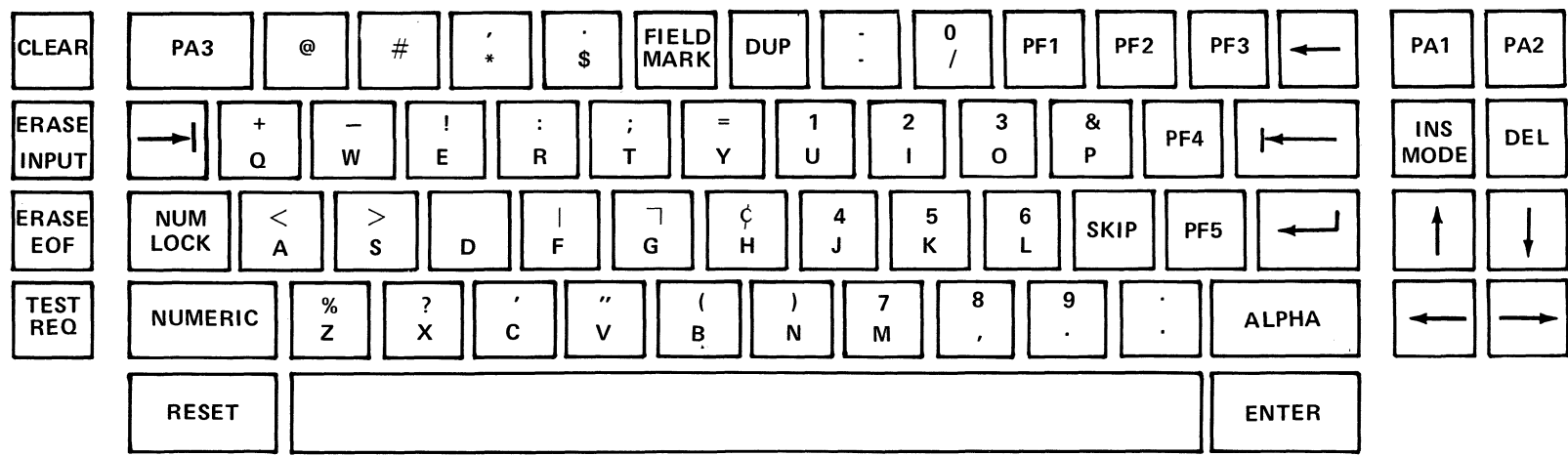

LOCALLY ATTACHED 3270 DISPLAY SYSTEM

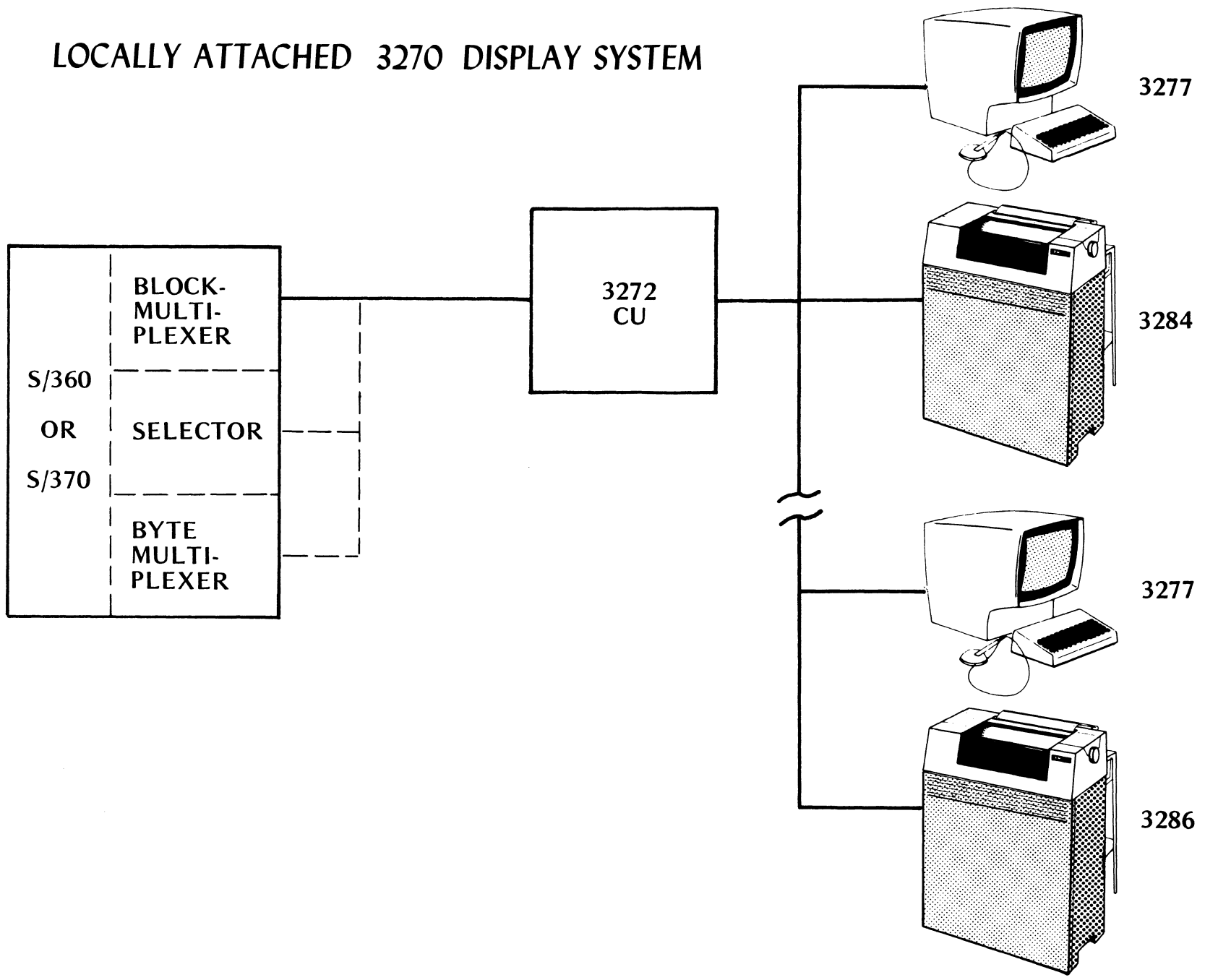

1-V-7

FUNCTIONS OF 3272 CONTROL UNIT

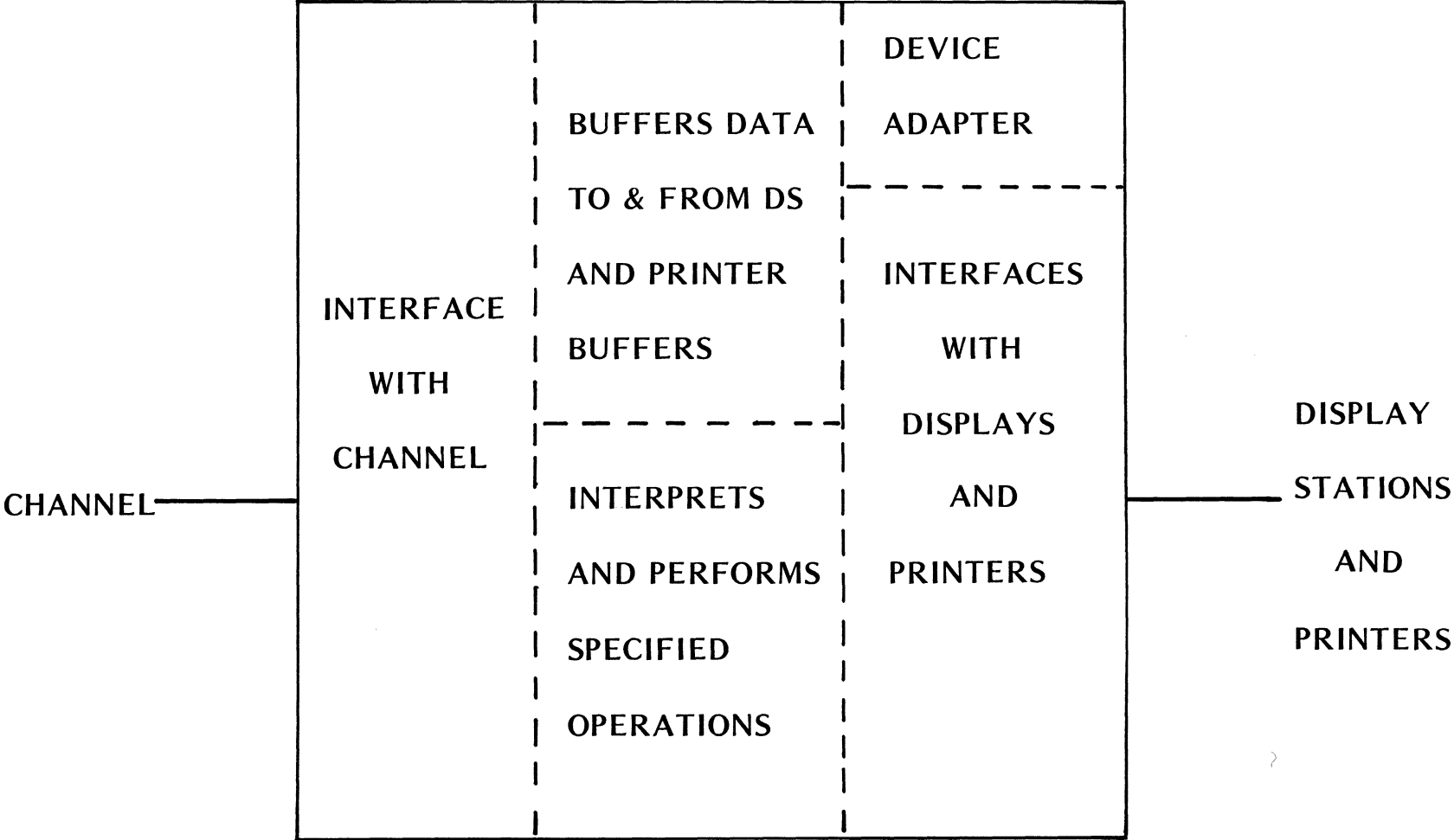

1-V-8

LOCALLY ATTACHED 3270 DISPLAY SYSTEM

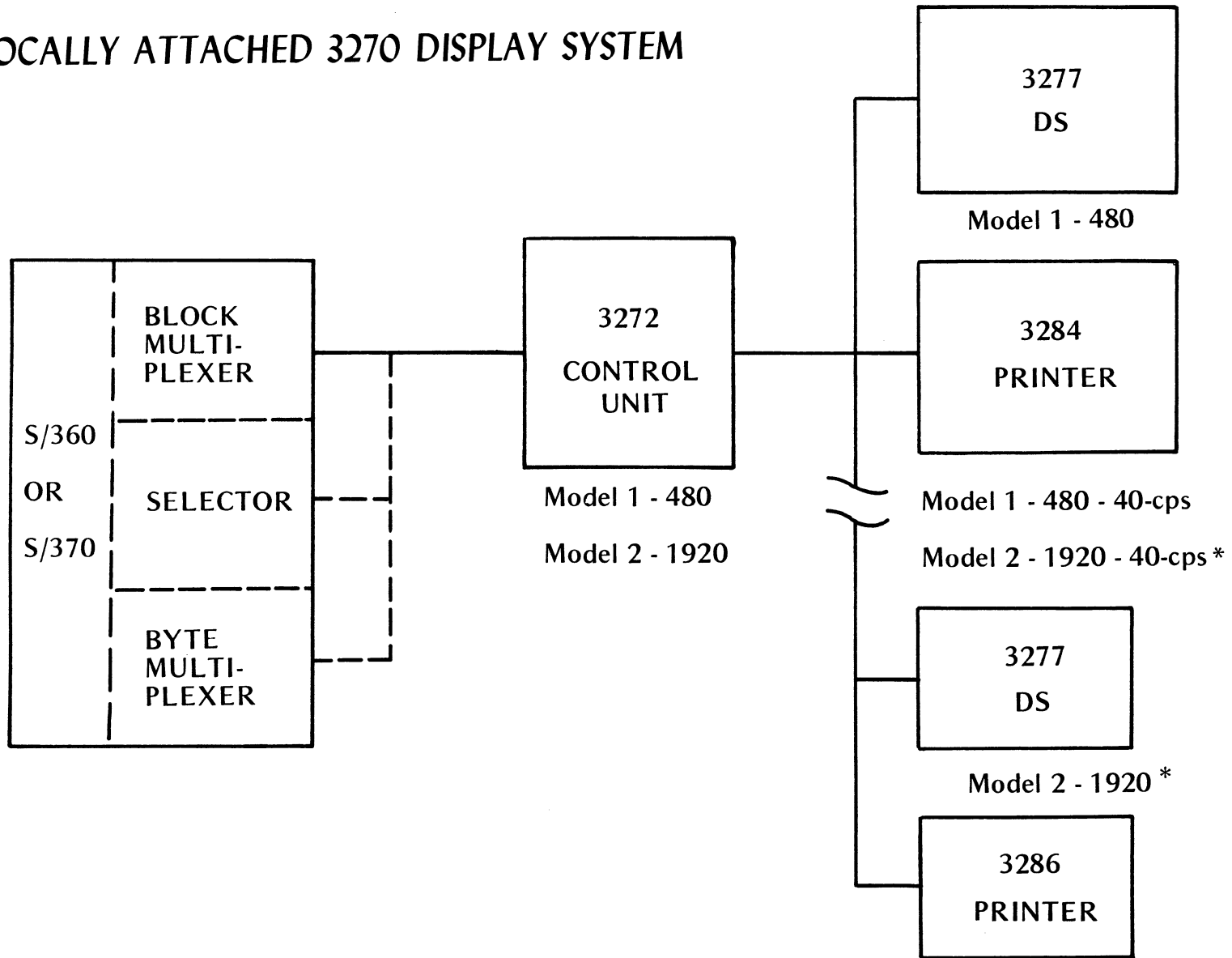

1-V-9

* REQUIRES MODEL 2 CONTROL UNIT

Model 1 - 480 - 66-cps

Model 2 - 1920 - 66-cps *

REMOTELY ATTACHED 3270 DISPLAY SYSTEM

1-V-10

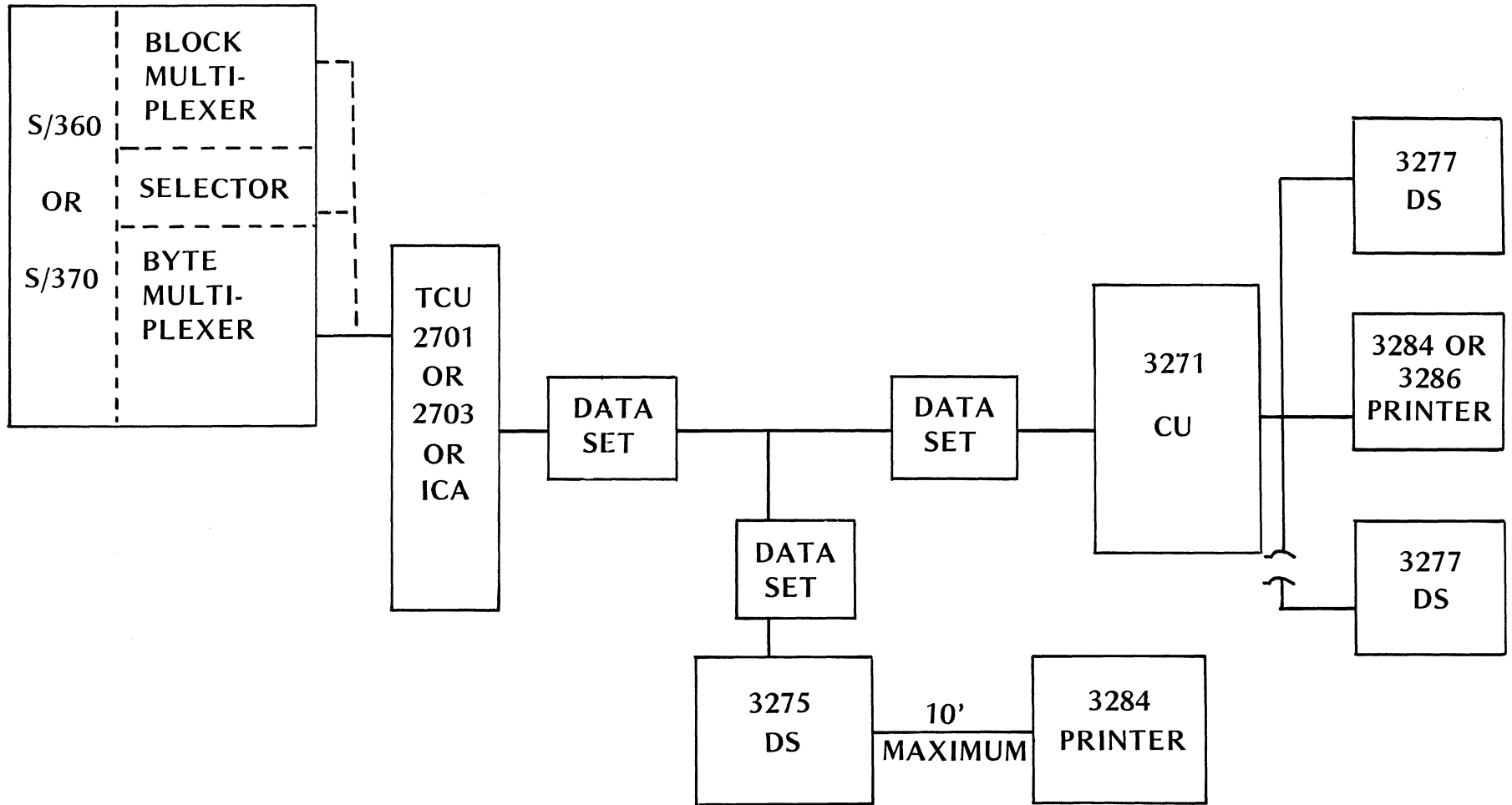

FUNCTIONS OF 3271 CONTROL UNIT

1-V-11

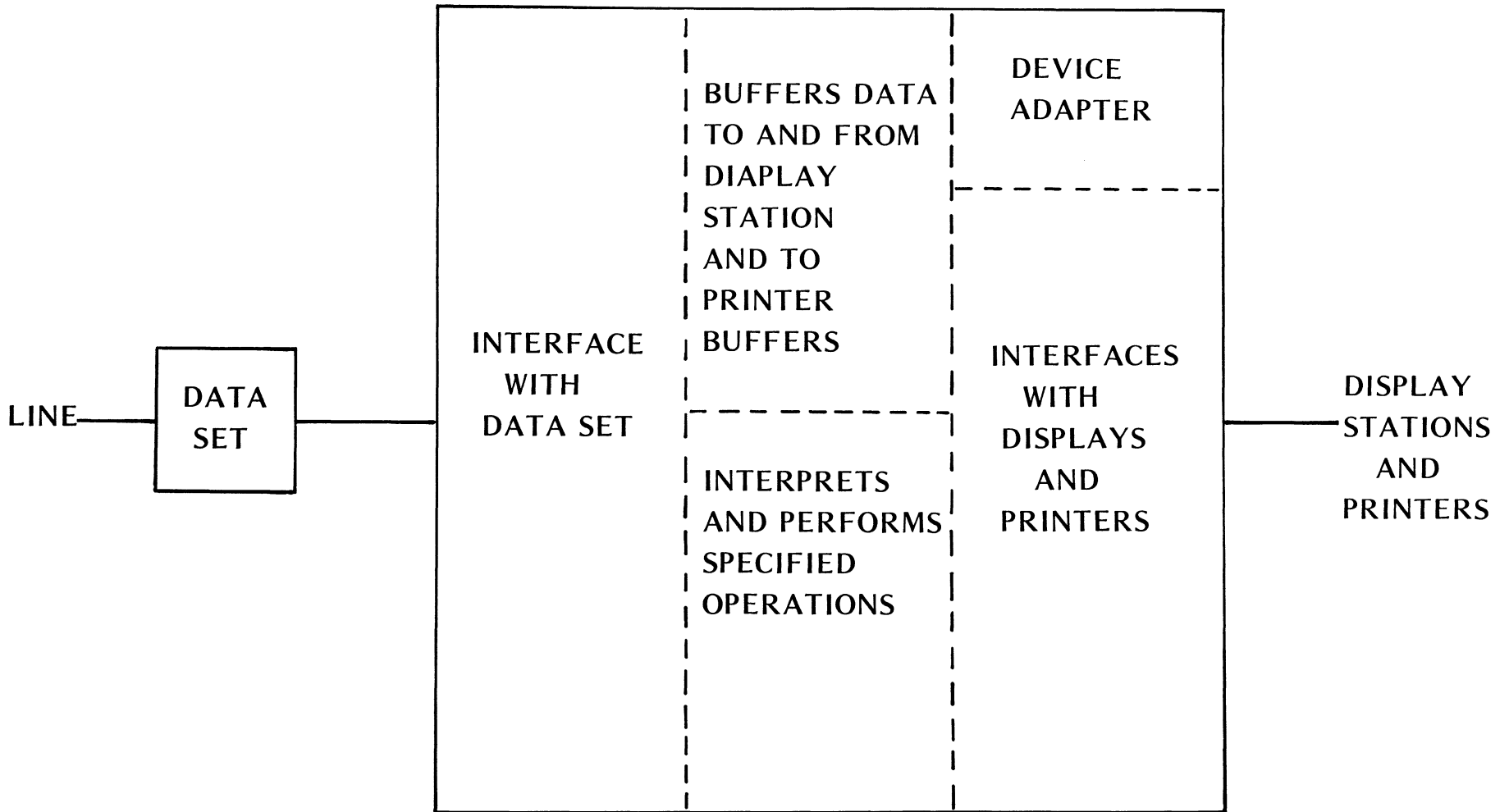



.

.



.

.



TOPIC 2 - REMOTE OPERATION

NOTE: In examining the operation of the 3270 Display System, including screen design and data stream formats, most of the time will be spent on the remotely attached system. Except for commands and BSC control characters this data stream will be the same as the local data stream.

A. BSC Multipoint Data Link Control for 3270

NOTE: BSC is a prerequisite and may have been reviewed after the prerequisite test, therefore, the instructor may not need to spend much time on this subject.

1. Features

a. Supports multiple BSC device on line.

1) 3271 CU

2) 3275 Stand-alone

3) Other BSC terminals

2770, System 3, Mod 20, 2780, 3735,
1130

b. A line can operate in EBCDIC or ASCII

c. Improved checking on transmission

2. BSC data link control review

a. Polling example

(2-V-1)

b. Selection example

(2-V-3)

NOTE: Foils 2-V-2 and 2-V-4 are provided as another way to illustrate the exchange of control and data between the CPU and remote 3270.

3. I/O operations on line controlled by BTAM channel programs.

NOTE: This is not a programming course; therefore, do not get involved with a discussion of BTAM channel programs. The main point to be made here is that the normal READ and WRITE channel commands used in most BTAM channel programs are employed. When the topic of local support comes up the channel commands will be considerably different.

B. Data Stream Contents

1. Polling or selection sequence

- a. EOT establishes control mode
- b. CU and DS address

NOTE: These addresses will take the place of "AA11" and "aa99" on foils (2-V-1) and (2-V-3).

2. Output data stream - general format (2-V-5)

a. BSC text framing characters

- 1) STX - start of text
- 2) ETB or ETX

ETB indicates another block to be transmitted from 3270. ETX indicates last block.

NOTE: On polling 3270, CPU can receive multiple blocks since remote 3270 will break long data streams into shorter blocks for transmission. For transmission to the remote 3270, all blocks will end in ETX since it does not recognize an ETB.

b. Command sequence

- 1) Indicates function to be performed at specified remote 3270.

NOTE: When working with locally attached 3270's there would not be a command sequence in the data stream. Instead the channel command would specify the function to be performed. This will be covered in detail under local operation.

c. Set Buffer Address (SBA) sequence

- 1) Indicates the address in the buffer where the following text is to be stored. This determines the screen or printer image.

d. Start Field (SF) sequence

- 1) Specified beginning of a field and the characteristics of the field, e.g.,

Protected or unprotected, selector pen detectable, brightness, etc.

C. Example of Screen Format

(2-V-6)

NOTE: Either 1-V-5 or 1-V-6 may be used by the instructor if he wishes to write his own example on the screen.

NOTE: Instructor must start emphasizing the important concept of field oriented display.

1. Field oriented concept

- a. Each field positioned on screen by SBA sequence.
- b. Characteristic of field determined by attribute code.

- 1) SF precedes attribute code.

- 2) Attribute code

- a) Takes position in buffer.

- b) Not displayed on screen.

- c) Field separator for visual purposes attribute code automatically gives blank.

NOTE: In foil 2-V-6 [] represents attribute code. The fields shown in the foil are protected and normal intensity. Fields to be entered are unprotected and the salary field is also non-displayed (brightness off).



BSC DATA LINK CONTROL (POLLING)

CPU

E		E		A		A
O	AA11	N		C 1		C 0
T		Q		K		K

3270

S	E b	S	E b	E
T TEXT	T c	T TEXT	T c	O
X	B c	X	X c	T

NOTE: "AA11" POLLING CHARACTERS ARE EXAMPLES AND NOT INTENDED TO BE ACTUAL 3270 CHARACTERS.

BSC DATA LINK CONTROL (POLLING)

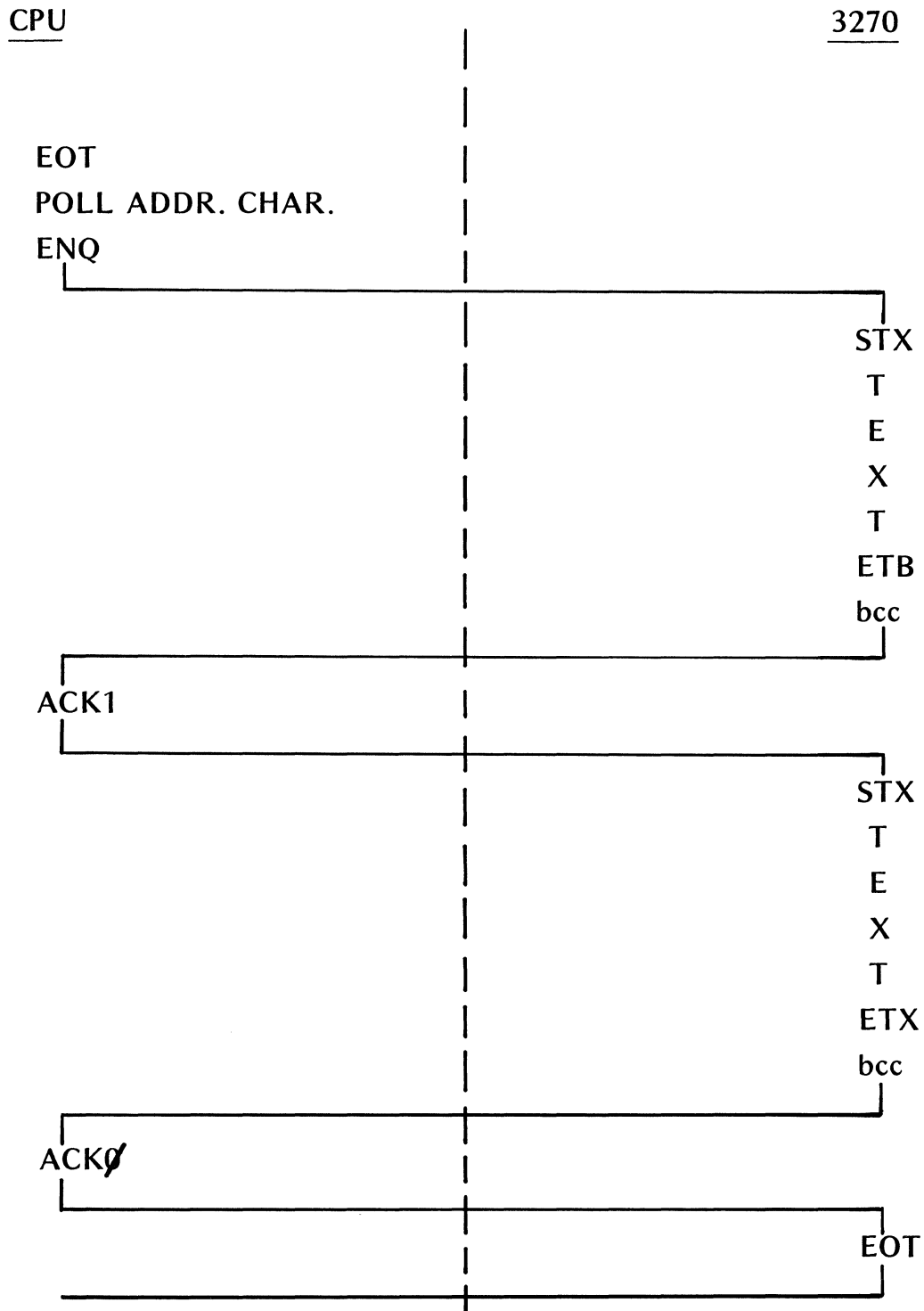

BSC DATA LINK CONTROL (SELECTION)

CPU

E		E	S	E b	E
O	aa99	N	T TEXT	T c	O
T		Q	X	X c	T

3270

A	A
C Ø	C 1
K	K

NOTE: "aa99" SELECTION CHARACTERS ARE EXAMPLES AND NOT INTENDED TO BE ACTUAL 3270 CHARACTERS.

BSC DATA LINK CONTROL (SELECTION)

CPU

3270

EOT
SELECTION ADDR. CHAR.
ENQ

ACKØ

STX
T
E
X
T
ETX

bcc

ACK1

EOT

REMOTE 3270 OUTPUT DATA STREAM

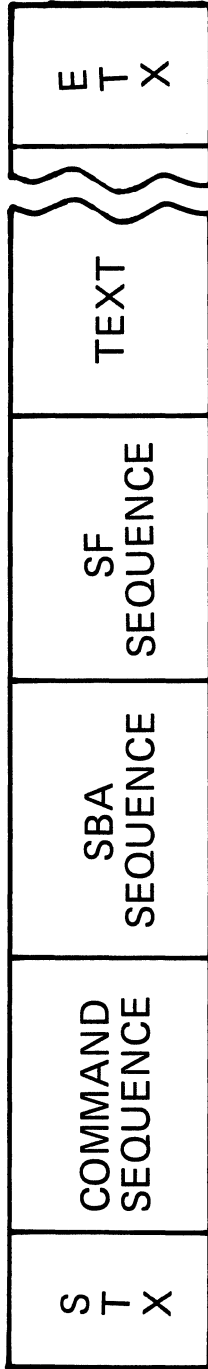

TOPIC 3 - CREATING SCREEN FORMAT AND BUILDING OUTPUT
DATA STREAM FOR REMOTE 3270.

NOTE: Instructor may find it useful to see foil
3-V-1 to illustrate what happens on screen
when discussing some of the concepts in this
topic.

NOTE: The hex codes for all commands, addresses, or-
ders, attribute code, and AID bytes are un-
available for release at the time this Educa-
tion Guide is being written. Therefore, these
bytes will be represented symbolically.

A. Components of Data Stream

1. General Contents of data stream

a. Commands

Cause CU to perform specified function.
For example, erase screen and write mess-
age.

b. Orders

- 1) Causes certain device related opera-
tions to be performed.

For example, position cursor.

c. Control characters

BSC characters
Attribute code

d. Text

2. Start Field sequence

(3-V-2)

a. Start Field (SF) order.

- 1) Indicates beginning of a field.
- 2) Precedes attribute code in output data
stream.

NOTE: The other orders will be covered as they are
needed for student exercises.

b. Attribute (ATT) code

- 1) General considerations

- a) Occupies displayable position
- b) Controls characteristics of field until another attribute code in data stream.
- c) Can be entered only under program control as part of data stream.
- d) Once an attribute code is given, it pertains to all following buffer locations until another attribute code is encountered. This also pertains in a wraparound situation.
- e) Presence of an attribute code implies formatted buffer.

NOTE: The unformatted buffer is similar to 2260; therefore, may be first step in conversion of 2260 applications to 3270.

There would be no attribute character in any location of the buffer. The entire screen would be unprotected, alphameric, and normal brightness.

- f) Attribute code's position in buffer is protected from operator keying over it.

2) Characteristics

NOTE: Attribute code is a one byte character which has various combinations of bits set on indicate characteristics of a field.

- a) Protected or unprotected field.

Protected prevents operator from keying data into that field. Keyboard remains locked until operator depresses RESET.

Also provides a means of erasing variable data (unprotected) from the screen, while retaining headings (protected), etc.

- b) Alphameric and numeric.

Indicate whether field is to contain alphameric or numeric data.

- c) Brightness

Allows a field to be displayed at one of three intensities - normal, bright, or off.

Bright is used to highlight specific fields and off prevents the field from being displayed.

- d) Modified Data Tag (MDT)

Indicates whether a field has been modified either under program control or from the keyboard.

Normally, the MDT will be set by K/B entry as opposed to program control.

- e) Selector pen detectable

Allows a field to be selected for input by using a selector pen.

- 3) Relationship between ATT code and operator functions.

- a) ATT codes act as tab stop.

When TAB key depressed cursor moves to next unprotected field.

BACKTAB causes following cursor movement:

If cursor in protected field, ATT character, or first alphameric character location of unprotected field, it moves to first position of preceding unprotected data field.

If cursor located in any other position in unprotected field, it moves to first position in that field.

b) Autoshift - Data entry K/B only.

Numeric in ATT code causes autoshift. If numeric lock feature on DS, entry of any other character than 0-9, ".", "-", and DUP will cause K/B to lock (autolock).

Can override autoshift with ALPHA key. If no numeric lock can enter any character and not cause autolock.

NOTE: When autolock occurs depress RESET to restore K/B.

c) Numeric ATT code with typewriter K/B.

No autoshift on numeric ATT code.

If numeric ATT code and numeric lock feature, entry of any character other than 0-9, ".", "-", and DUP will cause autolock.

If no numeric lock can enter any character.

d) Autoskip - All K/B's.

When keying into last position of a field and the next field is defined as protected and numeric, cursor will autoskip to the next unprotected field when that last operation is filled. If next field is protected alphameric, the cursor will move into that field and autolock will occur if entry is attempted.

3. Set Buffer Address (SBA) sequence

(3-V-3)

NOTE: The concept of the DS's CBA must be discussed and understood by the student during the presentation of the SBA sequence.

a) SBA order

- 1) Used in WRITE and ERASE/WRITE command data stream.
- 2) Resets CBA to a specified location.

Any write will cause data to be read into the buffer location specified by the DS's CBA. As each character is moved into the buffer the address is incremented by one.

The value in the CBA can be reset at any time by the data stream with an SBA.

b. Address

Following SBA order will be the two byte address to be used as the CBA.

c. Occurance

1) Establish position of first field.

Will normally occur early in the data stream for the first field.

2) Prior to new field

Will normally have SBA sequence coded prior to any new field to be displayed or defined.

4. Command Sequence

(3-V-4)

NOTE: There will be only one command sequence in an output data stream. This can be an area confusion to the student since there can be many SBA and SF sequences in a single output data stream.

a. ESC

BSC escape control character required prior to command.
This alerts CU that command follows.

b. Commands

NOTE: Only the commands which may be used to perform class exercises 2 and 3 will be discussed at this time.

1) Writes

a) Erase/Write

Clears entire buffer to nulls
Reset CBA to 0.
Places cursor at position 0.
Writes data into buffer as specified by rest of data stream.
Does not restore K/B.
Does RESET MDT.

NOTE: Nulls need not be transmitted when reading from the 3270. Blank characters would be transmitted on all reads.

b) WRITE

Write data as specified by rest of data stream.

CBA not reset until SBA sequence encountered in data stream.

NOTE: When using a WRITE command, the inclusion of an SBA sequence in the data stream is recommended to assure proper positioning of a message on the screen.

c. Write Control Character (WCC)

1) Function

a) First character in data stream following every ERASE/WRITE and WRITE command.

b) Further defines write operation.

Indicates whether output is for printer or DS.

Printer format information.

Sound audible alarm.

Restore K/B.

Reset MDT in attribute code.

NOTE: Show class how to use forms for exercise. Two foils are provided, 3-V-5 and 3-V-1. The instructor may choose to use the example or write his own example on 3-V-1.

Class Exercise 2 - Building of output data stream.
(20 min.)

DAY 2

B. 3270 Remote Output Data Stream Continued.

NOTE: This portion of the class is directed at expanding on the last class exercise to use additional functions of the 3270. In effect it is a continuation of the data stream developed in Class Exercise 2.

1. Additional orders

a. Insert Cursor (IC)

(3-V-6)

NOTE: This is the only order which will cause the cursor to be repositioned.

- 1) Included in ERASE/WRITE or WRITE data stream.
- 2) Cursor will be positioned at location specified by the CBA.
 - a) Therefore, IC must be given in data stream when CBA is set at desired value, or
 - b) SBA sequence can be issued prior to IC.
- 3) IC itself does not cause CBA to be incremented.
- 4) Will normally set cursor at beginning of first unprotected field into which operator is to key data.
- 5) Once operator entry of variable data is initiated, the CBA will be the same as the cursor's position.

NOTE: Other than when entering data, there is no relationship between cursor position and CBA. For example, the IC order can be followed by additional data which will keep incrementing the CBA. However, as soon as the operator enters data into the cursor position, the CBA is changed to reflect that location.

b. Repeat to Address (RA)

(3-V-7)

- 1) Included in ERASE/WRITE or WRITE data stream.

- 2) Inserts a specified character (alphanumeric or null) in all locations beginning at CBA up to but not including address specified in data stream.
 - a) User must be sure of CBA prior to coding this character in data stream.
- 3) CBA incremented every time character is repeated.
- 4) Specified character can be followed by regular text which will start following last repeated character.

2. Selector pen detectable fields

- a. Optional feature
- b. Provides operator with means of identifying a portion of a displayed message for entry into the processor without using the keyboard.
- c. Attribute code indicates whether field is selector pen detectable.
- d. Modified data tag (MDT) is set in attribute code when detection is accomplished with pen.
- e. Field format for detectable field. (3-V-8)
 - 1) Attribute code must indicate field is selector pen detectable.
 - 2) Designator character.

NOTE: Foils 3-V-9 and 3-V-10 are provided for additional examples of selector pen detectable fields.

- a) ? or)

Normally a "?" would be sent in output data stream. When detection is made on that field, the "?" is changed to ") " and the MDT is set on.

If detection should then be made on a field with " ", it is changed to "?" and the MDT is set off, thus providing a means of negating a previous selection.

b) Nulls or blanks

If the designator character is null or blank, the selector pen detection:

Will not change display.
Will set MDT on.
Requests service and locks
K/B;
therefore, selection is irreversible.

NOTE: No other graphic can be used for a designator character.

3) At least one character in addition to designator character must be displayed.

NOTE: A blank is frequently left between the designator character and displayed character for clarity; however, it is not necessary.

NOTE: Actual detection can be made on the displayed alphanumeric character or the designator character when "?" or ">" is present.

4) Concluding nulls or blanks

a) At least three nulls or blanks at end of field to provide buffer zone to next detectable field.

b) If last field on line, 3 nulls or blanks not required.

NOTE: If when creating a selector pen detectable field, the program knows nulls already exist in the field (e.g., ERASE/WRITE command has been issued), it would not be necessary to transmit nulls in the output data stream.

Class Exercise 3 - Expansion of output data stream.
(30 min.)



.

.



.

.



0	1	2	3	4	5	6	7	8	9	10	11	12	13	14	15	16	17	18	19	20	21	22	23	24	25	26	27	28	29	30	31	32	33	34	35	36	37	38	39
---	---	---	---	---	---	---	---	---	---	----	----	----	----	----	----	----	----	----	----	----	----	----	----	----	----	----	----	----	----	----	----	----	----	----	----	----	----	----	----

0																																													
40																																													
80																																													
120																																													
160																																													
200																																													
240																																													
280																																													
320																																													
360																																													
400																																													
440																																													

3-V-1

REMOTE 3270 OUTPUT DATA STREAM

SF SEQUENCE

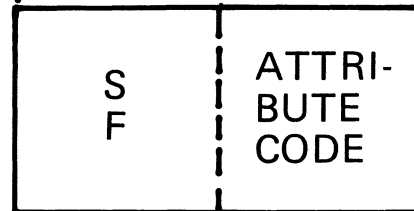
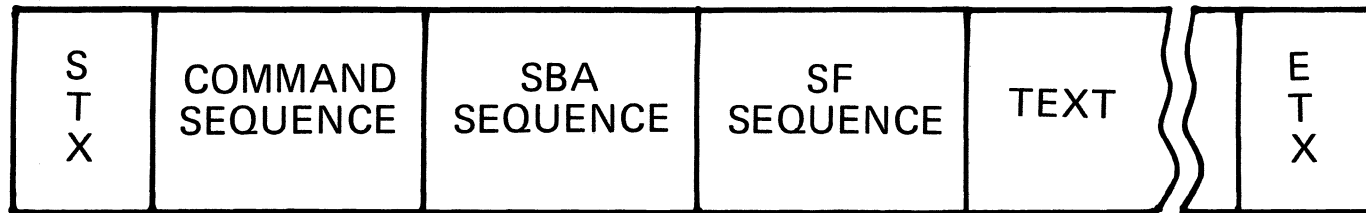

CHARACTERISTICS

PROTECTED
UNPROTECTED
BRIGHTNESS
NUMERIC
SELECTOR PEN DETECT
MODIFIED DATA

REMOTE 3270 OUTPUT DATA STREAM

SBA SEQUENCE

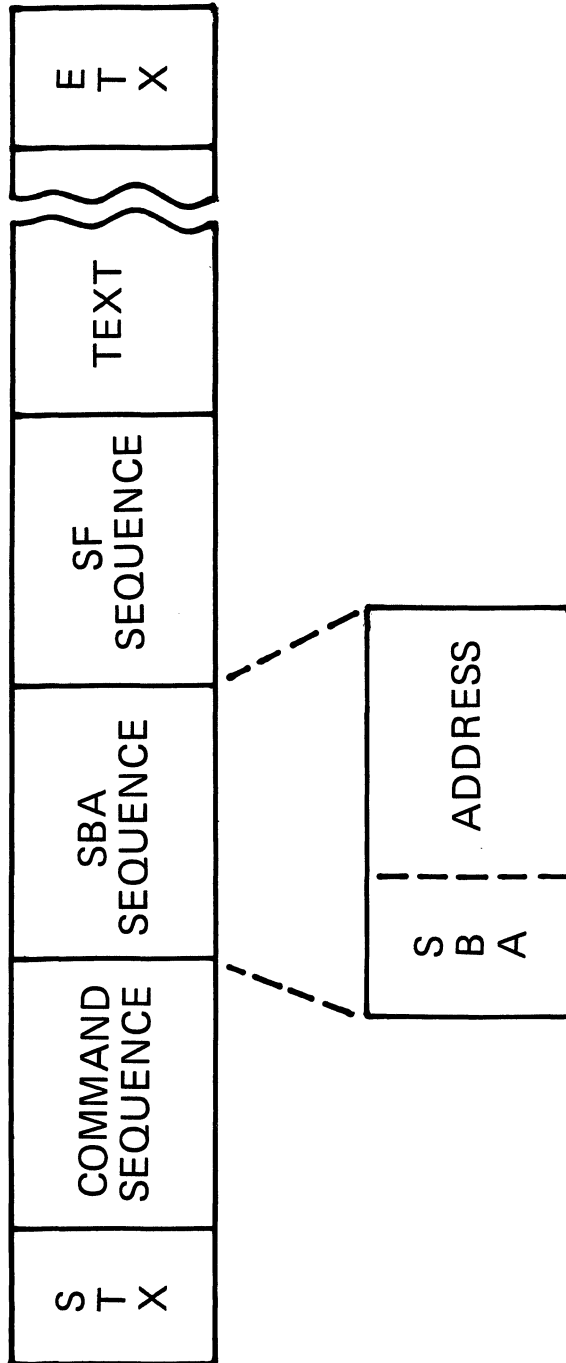

REMOTE 3270 OUTPUT DATA STREAM
COMMAND SEQUENCE

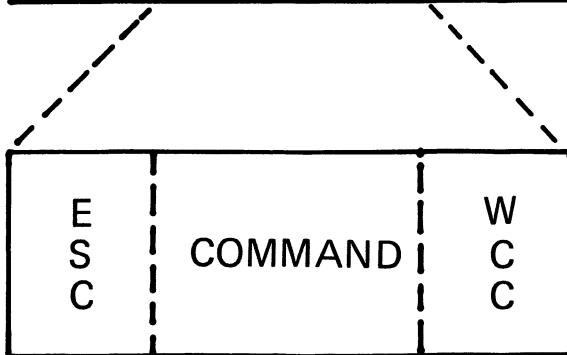
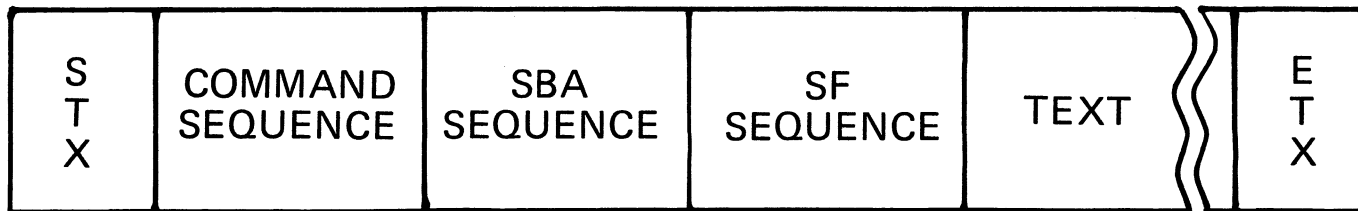

COMMANDS

ERASE/WRITE
WRITE

WCC

KEYBOARD RESTORE

3-V-4

0 1 2 3 4 5 6 7 8 9 10 11 12 13 14 15 16 17 18 19 20 21 22 23 24 25 26 27 28 29 30 31 32 33 34 35 36 37 38 39

0																																						
40																																						
80																																						
120																																						
160																																						
200																																						
240																																						
280																																						
320																																						
360																																						
400																																						
440																																						

ACCOUNT #

3-V-5

S T X	E S C	WR	WK,WM	S B A	170	S F	P,R	ACCOUNT #	S F	U,H	S B A	_____	E T X
-------------	-------------	----	-------	-------------	-----	--------	-----	-----------	--------	-----	-------------	-------	-------------

3270 OUTPUT DATA STREAM

INSERT CURSOR SEQUENCE

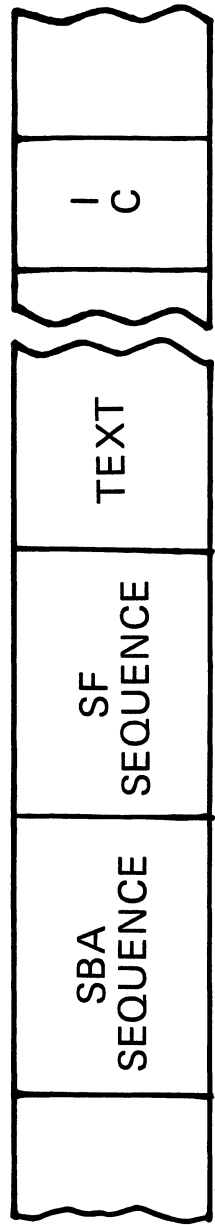

OR

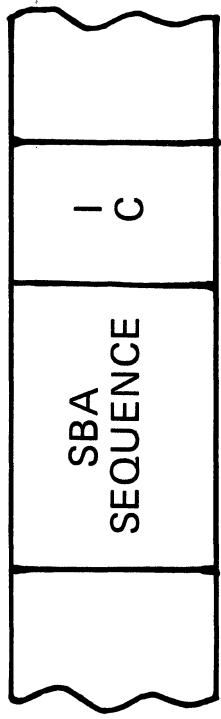

3270 OUTPUT DATA STREAM

REPEAT TO ADDRESS

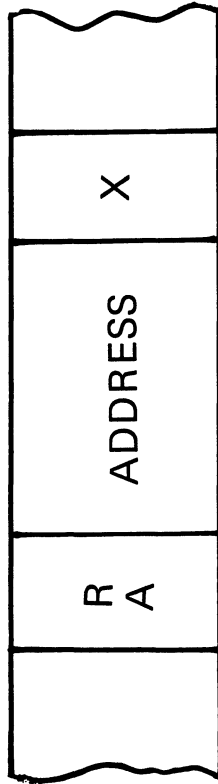

OR

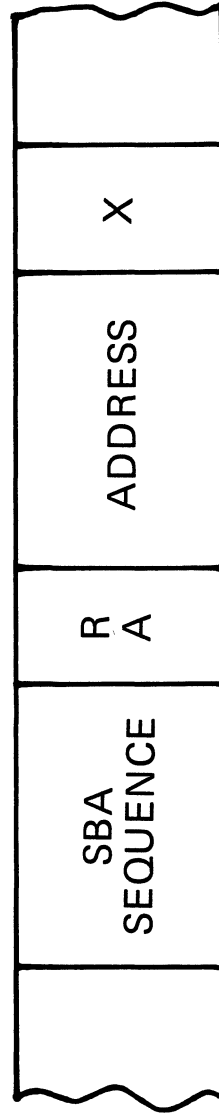

FIELD FORMAT FOR SELECTOR PEN DETECTION

	0	1	2	3	4	5	6	7	8	9	10	11	12	13	14	15	16	17	18	19	20	21	22	23	24	25	26	27	28	29	30	31	32	33	34	35	36	37	38	39										
0																																																		
40																																																		
80																																																		
120																																																		
160																																																		
200																																																		
240																																																		
280																																																		
320																																																		
360																																																		
400																																																		
440																																																		

S F	ATT CODE	DESIGNATOR	1 OR MORE DISPLAYED ALPHAMERIC	3 / OR / (IF NOT LAST FIELD ON LINE)
--------	-------------	------------	--------------------------------------	--

? ~~/~~ ~~/~~

8-V-8

SELECTOR PEN EXAMPLE

TP CLASS ENROLLMENT

NAME:

ADDRESS:

? CUSTOMER

? IBM

CLASS

? CSD & A

? BTAM

? TCAM

? 3270

DONE

SCHEDULE

R. JONES 2/22/71 HOSPITAL VISIT CARE-NORMAL FOOD-SAME

DRUGS — ASPIRIN

STRENGTH —	? FULL	? 1/2	? BABY
DOSE	? 20 MG	? 50 MG	? 100 MG
DAILY SCHED	? 1 TIME	? 2 TIMES	? 3 TIMES
	? 4 TIMES	? 6 TIMES	? 8 TIMES
	? 12 TIMES	? 24 TIMES	
	? AS REQUIRED		

DRUG A

DRUG B

DRUG C

DRUG D

EXIT

FOOD

HISTORY

TOPIC 4 - INPUT DATA STREAM FROM REMOTE 3270.

A. Types of Reads

1. Read Modified

NOTE: This will be the customary read employed when polling a remote 3270. The remote CU actually generates the Read Modified command when polled.

The BTAM channel programs are unavailable for release at the time this Education Guide is being written. Therefore, use foil 2-V-1 for general review purposes. Do not attempt to get into detail of this operation since that is not the intent of the course.

- a. Reads only fields which have been modified, e.g., MDT set on for protected and unprotected.

NOTE: MDT could have been set on for protected fields under program control.

- b. If unformatted buffer, will read entire buffer, e.g., 480 or 1920 positions.
- c. Short read

Under certain circumstances no data read, just certain control information.

NOTE: This occurs when PA key depressed. Short read will be discussed further in following lecture.

B. Components of Data Stream for Read Modified.

1. General contents of data stream.

- a. BSC control characters
- b. Source of message
- c. Identifies cause of response to poll
- d. Cursor location
- e. Field data

2. Source of Message

(4-V-1)

- a. CU and Device address or originating device.

b. Specific poll vs. general poll

1) Specific poll

Specific poll is used when checking to see if a specified device has anything to send.

Still will receive source address even though program knows who was polled.

2) General poll

a) When a 3270 CU has more than one DS connected to it, this poll will take message from whichever one is requesting service.

b) Significance of source

In the general poll it is essential that the responding device's address be included in the input data stream to know who was read.

3. Attention ID (AID) character

(4-V-2)

a. Operator causes request for service - I/O pending and setting of AID.

1) Enter

2) Clear

Causes short read.
Indicates to program that operator has cleared buffer.

3) Program Attention (PA) keys

Allows code to be transmitted to the program to identify which key was depressed, without transmitting text.

Example of use would be to instruct program to cancel last input received.

4) Program Function (PF) keys

Allows any input data on the screen to be transmitted to the program together with a code that identifies which program function key was pressed.

Example of use would be to request a certain application program to process the data just entered.

NOTE: PF keys do cause I/O pending and setting of AID. Therefore, if operator wishes to send both data and PF indication, he must depress the specified PF key after keying in the data.

5) Selector pen detect

With blank or null causes I/O pending and setting of AID.

With "?" causes only setting of MDT.

6) Cancel

For operator console K/B - replaces a PA key.
Short read

7) Test Request

Used for device testing purpose. Permits initiation of on-line test program.

b. AID identifies which of these operations were performed by the operator.

c. I/O pending also set at device.

I/O pending causes remote device to send a message when polled.

Device inoperative as long as I/O pending.

d. Resetting of AID.

1) Erase All Unprotected command.

NOTE: This command will be covered shortly.

2) WCC in output data stream.

Restore K/B
Resets AID
Resets MDT

NOTE: RESET key can reset an existing I/O pending condition and the AID character as long as I/O is not in progress. This type of usage should seldom occur.

4. Cursor address

Indicates location of cursor at time Read Modified was issued.

5. Field data

(4-V-3)

a. Field data received for every field modified, i.e., MDT set on.

1) SBA

2) Buffer address of first character position in modified field.

Will be as many field data sequences as fields modified (MDT set on).

3) Text

Alphameric data of each field
Null characters not included in data stream.

NOTE: Under certain circumstances, e.g., long input streams, the input may consist of more than one transmission block. In this case all blocks will end with ETB except the last which ends with ETX. After the first block all other blocks start with STX which is immediately followed by next field data.

It is recommended that the instructor does not get involved with the concept of multiple blocks since most transmissions will only be one block due to transmission of only modified fields. Also, at the time this Education Guide was prepared the block length was not available.

C. Erasing Under Program Control

NOTE: Besides the ERASE/WRITE command the user has two other methods available to erase, all or portions of the screen. One involves the use of a command (EAU) while the other is done by use of an order (EUA) in the data stream. Either may be employed by the student in student exercise 4; however, the EUA order will offer the best solution.

1. Erase/Write Command - already discussed.

2. Erase All Unprotected(EAU) command

a. Functions

- 1) Clears all unprotected alphameric characters to nulls.
- 2) Resets MDT in attribute code for all unprotected fields.
- 3) Unlocks K/B
- 4) Reset AID
- 5) Repositions cursor to first character location in first unprotected field in buffer.
- 6) CBA unchanged

b. Data stream

(4-V-4)

No text transmitted

NOTE: The EUA command or EUA order will not cause ") " to be changed back to "?" in a protected selector pen detectable field. Therefore, if it is necessary to reset the screen image to display "?" once it has been changed to ") ", the "?" must be written out in the data stream.

This information may be used by the student to perform part of exercise 4.

3. Erase unprotected To address (EUA)

(4-V-5)

a. Can be included in Write or Erase/Write data stream.

b. Operation

- 1) Erases (sets to nulls) all unprotected character locations in buffer storage, beginning with CBA and continuing to, but not including, address in order sequence.
- 2) If CBA equal to address in sequence, all unprotected character locations erased.
- 3) Operation may wrap
- 4) No effect on cursor location

- 5) CBA is modified to reflect address associated with EUA order.
- 6) K/B is not restored.
- 7) AID is not reset
- 8) MDT's for fields effected are not reset.

NOTE: Can erase all unprotected fields, an entire field, portion of a field, or a single character depending on CBA and address in the order sequence.

c. Use

Provides a means of erasing variable data on a screen after a read without erasing the protected image format.

Screen would then be ready for new variable information to be entered.

D. Additional Read Command Considerations

1. Read Modified command - short read

a. Only brings in

(4-V-6)

- 1) Source
- 2) AID

To indicate reason for requesting service.

- 3) No field data since no MDT bits set on.

b. Occurs when

- 1) Clear
- 2) Program Attention (PA) keys
- 3) Cancel - replace PA key on operator console K/B.

2. Read Buffer command

(4-V-7)

- a. The contents of the entire buffer transferred.

Protected and Unprotected fields.

Attributes codes preceded by SF.
Alphameric characters.
Nulls and blanks.

b. Used primarily for debugging

Class Exercise 4 - Input data stream and erasing of
screen. (45 min.)



.

.



.

.



REMOTE 3270 INPUT DATA STREAM

SOURCE OF MESSAGE

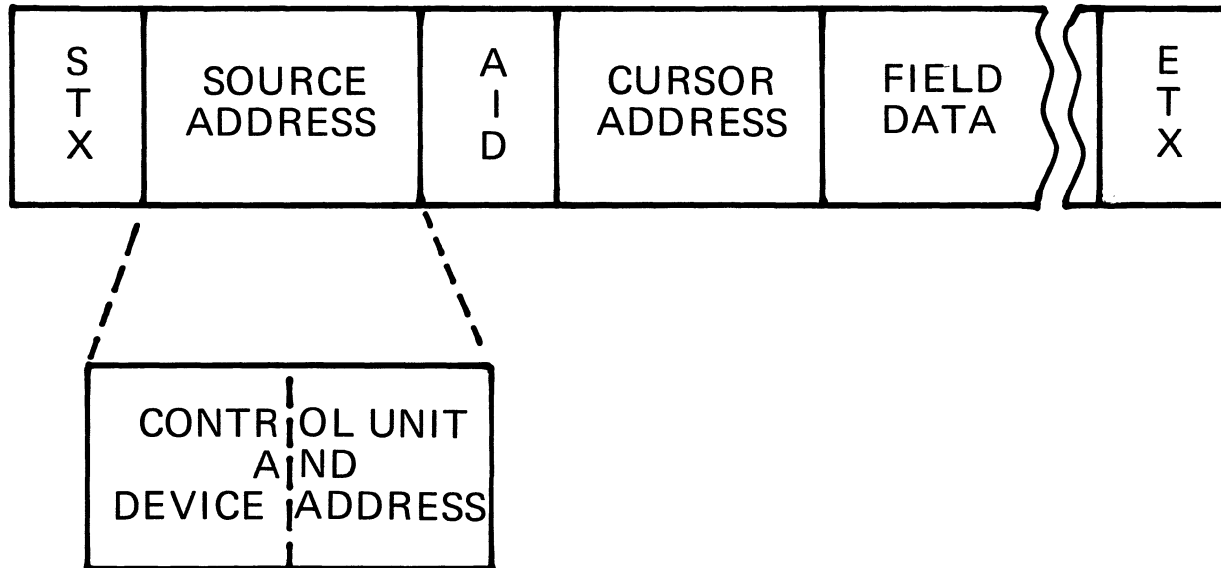

REMOTE 3270 INPUT DATA STREAM
ATTENTION ID

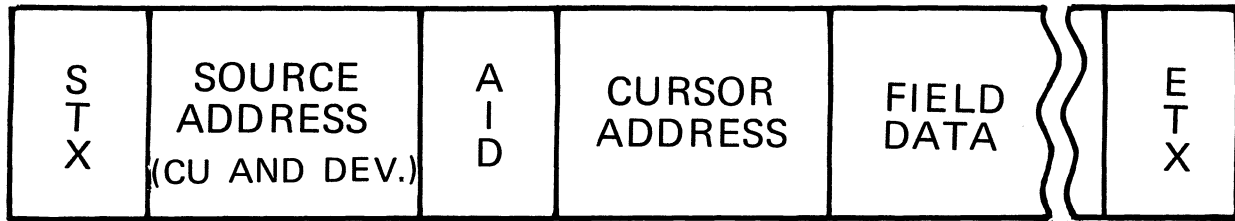

AID SETTINGS

- ENTER
- CLEAR
- PA KEYS
- PF KEYS
- SELECTOR PEN DETECT
- CANCEL
- TEST REQUEST

4-V-2

REMOTE 3270 INPUT DATA STREAM

FIELD DATA

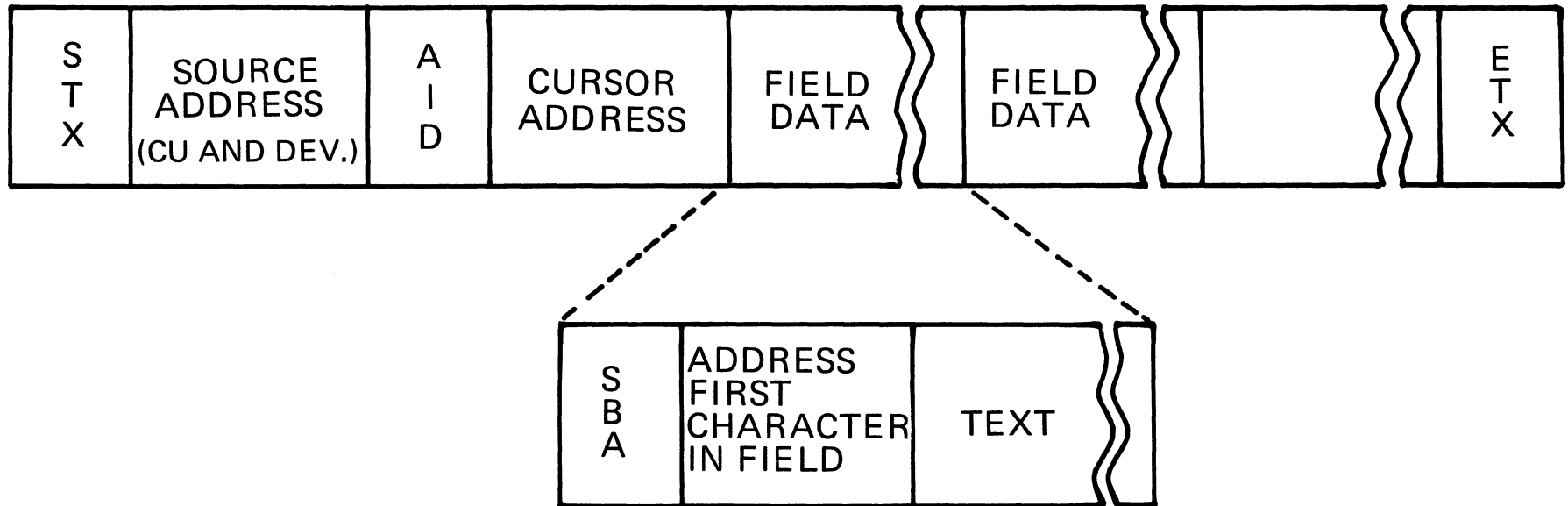

REMOTE 3270 OUTPUT DATA STREAM
ERASE ALL UNPROTECTED

S T X	E S C	E A U	E T X
-------------	-------------	-------------	-------------

REMOTE 3270 INPUT DATA STREAM FOR SHORT READ

(READ MODIFIED ON CLEAR OR PA/CANCEL)

S T X	SOURCE ADDRESS (CU AND DEV.)	A I D	E T X
-------------	------------------------------------	-------------	-------------

REMOTE 3270 INPUT DATA STREAM FOR READ BUFFER

4-V-6

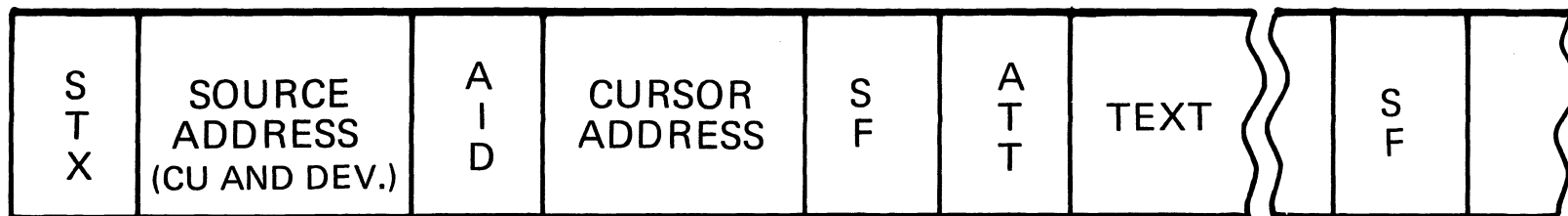

ERASE UNPROTECTED ORDER SEQUENCE

(EUA)

CBA ALREADY SET AT 40

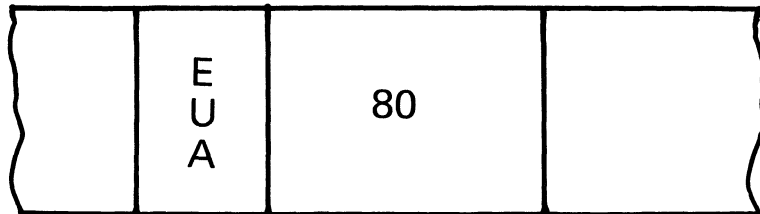

CBA UNKOWN

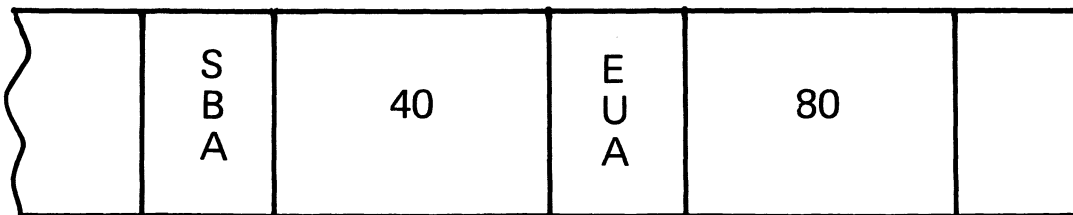

*IN BOTH CASES ERASE ALL UNPROTECTED POSITIONS
FROM LOCATION 40 TO 79.*



.

.



.

.



DAY 3

TOPIC 5 - LOCAL OPERATION

NOTE: Much of the information covered in the remote operation will pertain to the local operation. Two of the most significant points to be made are that:

Commands will not be in the data stream. Instead there are channel commands to perform the specified function.

There is no need for BSC data link control; therefore, all of those control characters are eliminated.

A. Output Data Stream

1. Channel commands

a. Writes

1) Effect of current buffer address (CBA)

Same significance as with remote, e.g., will indicate where field is to be displayed.
SBA sequence resets the address.

2) ERASE/WRITE channel command

a) Functions

Same as remote, e.g.;
Clears entire buffer to nulls.
Sets CBA to 0.
Places cursor in position 0.
Writes text as specified by rest of data stream.
Does not restore K/B.
Does reset MDT.

b) Data stream format

(5-V-1)

WCC - same meaning as remote

Orders and text - same as remote

3) WRITE channel command

Same as remote.
Write data as specified by rest of data stream.

CBA remains unchanged until SBA sequence encountered in data stream.

4) ERASE ALL UNPROTECTED channel command

Functions same as remote command.
No data stream - only issue command.
Clears all unprotected alphanumeric fields to nulls.
Resets AID.
Resets MDT for all unprotected fields.
Restores K/B.
Positions cursor to first character location in first unprotected field in buffer.
CBA unchanged.

B. Input Data Stream

1. Channel commands

a. Reads

1) READ MODIFIED channel command

a) Function

Same as remote

b) Data stream

(5-V-2)

NOTE: Will read entire modified data stream with a single read. No blocking as might occur in remote.

c) Short read format

(5-V-3)

Caused by same operations as in remote.

NOTE: Source address is not included in any of the local input data streams. At this point the instructor may have to briefly review channel operations. That is, the local 3270 will generate an interrupt and the device causing the interrupt will be specified in the old PSW. Therefore, the supervisor or access method will obtain the source address for the reads from the old PSW interruption code.

This is probably a good point to make since it will reemphasize that the local operation is completely under the control of channel commands while the remote operation is under control of commands in the data stream.

- 2) READ BUFFER channel command
 - a) Function - same as remote
 - b) Format

Same as remote except no BSC character or source address.

b. SELECT channel command

NOTE: To appreciate the usefulness of this command the instructor must describe one aspect of the 3270 operation. The display station regen buffer must be brought into the CU buffer when commands are issued to the CU. This operation may take up to 70 MS. Rather than have a delay of this sort in a read or write operation, the Select Command is available for use.

- 1) Function
 - a) Used only with local operation.
 - b) Usefulness realized when display system attached to block multiplexer channel.
 - c) Select command sent to CU to initiate buffer transfer. Channel would be available then for other functions.
 - d) On completion of the DS buffer to CU buffer transfer would then read buffer with a read command.

NOTE: Without the block multiplexer channel the SELECT channel command would require special programming by the user to effectively utilize it.

2) Data stream for Select command

No data stream

C. WCC, Orders, Attribute Code, AID

NOTE: This portion of data stream and its function is same as described for remote operation.

Class Exercise 5 - Local data streams (10 min.)



3270 OUTPUT DATA STREAM
ERASE/WRITE
WRITE

LOCAL

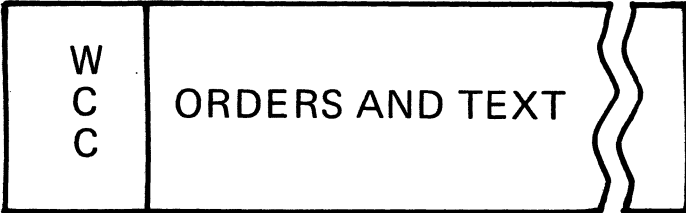

REMOTE

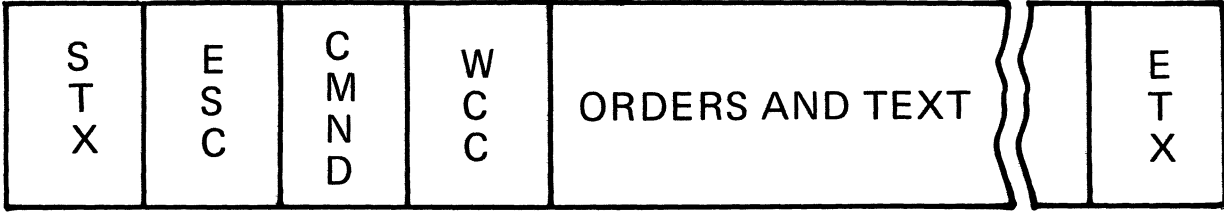

3270 INPUT DATA STREAM

READ MODIFIED

LOCAL

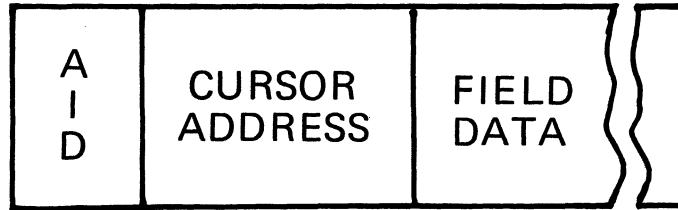

REMOTE

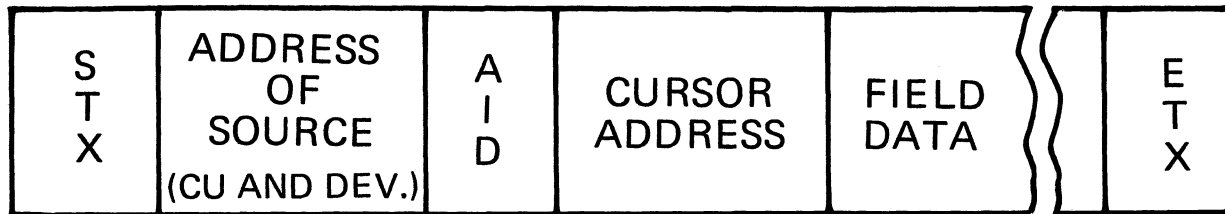

3270 INPUT DATA STREAM (SHORT READ)
READ MODIFIED

LOCAL

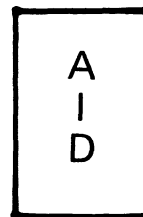

REMOTE

S T X	ADDRESS OF SOURCE (CU AND DEV.)	A I D	E T X
-------------	--	-------------	-------------



.

.



.

.



TOPIC 6 - PRINTER OPERATIONS

A. Hardware Considerations

1. 3284 or 3286 Printer associated with 3271 or 3272 CU.
 - a. Each printer in cluster will have its own buffer, as DS's have.
 - b. Will have a unique address.
2. Only Model 3 3284 printer with 3275 DS.
 - a. Single buffer services DS and printer.
Referred to as a dedicated printer.
 - b. Will not have unique address.
WCC in data stream causes printing.
3. Print positions - must specify when ordered.
 - a. 120, 126, or 132 characters per line.
 - b. 6 lines per inch.
 - c. 10 characters per inch.

B. Uses for Printer

1. To obtain hard copy of displayed information.
 - a. Processor to printer when information same as sent to DS.
 - b. DS directly to printer - remote only.
 - 1) This must be done under program control, e.g., operator depresses a specific function key which tells program to copy DS image on printer.
2. To obtain hard copy of text which is formatted specifically for printer output and not necessarily to be displayed at a DS, e.g., invoices.

C. Output to Remote Printer When Same as for DS, e.g., not especially formatted for printer

1. General data stream
 - a. BSC characters

(6-V-1)

- b. Command sequence
- c. Set buffer address sequence. Will indicate location in printer, buffer.
- d. Text

2. Command sequence

(6-V-2)

a. Command

1) ERASE/WRITE

Clears printer buffer to nulls.

2) WRITE

Write text into buffer location specified by CBA.

3) ERASE ALL UNPROTECTED

Operates same as with DS.

NOTE: Can issue Read Modified to printer which will read modified fields. In this case the MDT's would have to be set under program control for any fields to be read. The use of this command for the printer operation is unlikely; however, it does serve to illustrate the similarity between the printer buffer and DS buffer operation.

NOTE: Printing will always start with first position of buffer.

b. WCC

1) Start printer

2) Format - line length coincides with line lengths for DS.

a) 40 characters/line

b) 80 characters/line

NOTE: Line length has meaning only on buffered printer, e.g., printer connected to 3271 CU. If no line length specified, it will print to end of line (120, 126, 132) and start at the beginning of the next line.

3. SBA sequence

Sets CBA in printer buffer.

4. SF sequence

a. Defines field

1) Attribute code

a) If attribute code has brightness off following field will not print. Will be blanks.

b) Attribute character treated as a blank.

5. Other orders and text

a. Orders - Most orders function in same manner as with DS.

1) IC is ignored

Cursor not a printable character.

2) RA

Will repeat characters as with DS.

3) EUA

Erases unprotected to address as with DS.

b. Text

1) Prints what would appear on screen.

2) A line of all nulls and non-displayable characters - no line advance, no horizontal printing.

3) A line containing one or more blanks and rest of line is nulls and non-displayable characters - line advance and carriage return to cause blank line.

NOTE: With dedicated printer what is printed is also displayed since it is a common buffer.

D. Output Formatted Specifically for Remote Printer.

(6-V-3)

1. Program specifically for hard copy.
 - a. Reports and pre-printed form.
 - b. Will eliminate certain orders that really do not pertain to print out.
2. WCC
 - a. Additional printer specifications
 - 1) New Line (NL)

Enables insertion of NL character (order) in data stream which will be detected by CU and cause line feed and carriage return.
 - 2) End of Message (EM)

Enables program to insert EM (order) to prevent printing of entire buffer. Printing stops on encountering EM.
 - 3) NL and EM not honored when in non-displayable field.

Treated as blanks.

NOTE: When operating with NL and EM, 3270 does not recognize line length format in WCC.

NOTE: Dedicated printer honors NL and EM regardless of WCC setting.

3. SBA sequence

This sequence will still be valuable to establish start of print positions.

- E. Copy DS to Printer or DS to DS.

1. General Information

- a. Use at remote cluster only (not for dedicated) - 3271 CU.

Devices must be on the same control unit.

- b. Performed only under program control, e.g., operator depresses PF or PA key to inform program of copy requirement.

- c. On recognizing request for copy, the processor must send out a data stream with appropriate command.

2. Output data stream to perform copy

(6-V-4)

- a. Select device to receive copied information with BSC selection sequence.

- b. Write data stream to initiate copy.
(DS to Printer)

- 1) Command

Copy command

- 2) Copy Control Character (CCC)

- a) Starts printer

- b) Indicates length of print line.

- c) Specifies -

Copy only unprotected fields.

Copy only protected fields.

Copy all of screen.

- 3) Indicate address of device from which information is to be copied.

- c. Copy DS to DS

- 1) Use -

Efficient means of repeating same information on more than one DS in the cluster.

- 2) CCC

Indicates only what is to be copied.

Copy only unprotected.

Copy only protected.

Copy all of screen.

NOTE: Copying under program control assures that with successive copies the next copy is not started until the previous one is completed.

F. Output of Local Printer

1. Differences between remote and local. (6-V-5)
 - a. Local has no BSC characters.
 - b. Local has no command sequence.
 - c. Local has no copy function.
 - d. All local writes to printer performed with channel commands.

2. Output data stream to local - formatted for printer. (6-V-6)

Same as for remote except there are no BSC characters or command sequence.

Class Exercise 6 - Format data stream to perform printer operations. (30 min)

**OUTPUT DATA STREAM TO REMOTE PRINTER
(SAME AS FOR DS)**

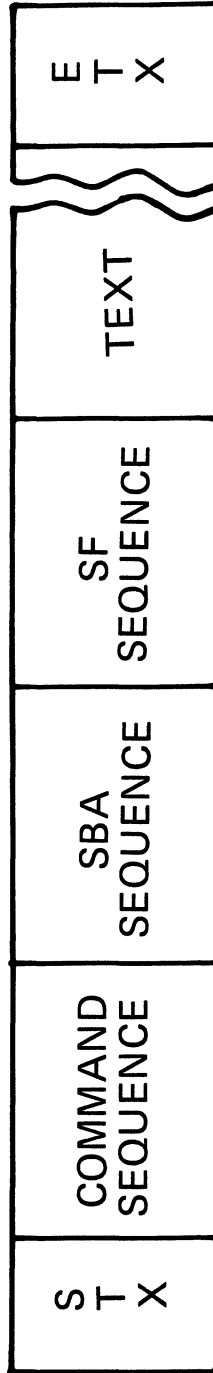

OUTPUT DATA STREAM TO REMOTE PRINTER

(SAME AS FOR DS)

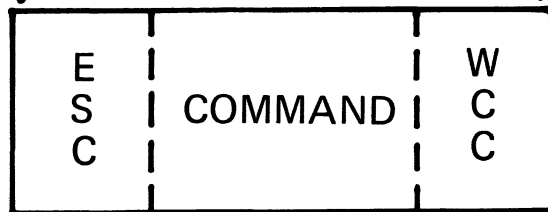
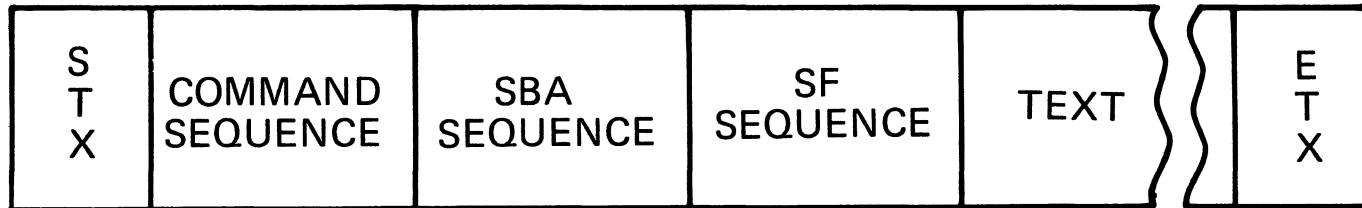

COMMANDS

ERASE/WRITE
WRITE

WCC

START PRINTER
LINE LENGTH
NEW LINE
END OF MESSAGE

OUTPUT DATA STREAM TO REMOTE PRINTER
(FORMATTED FOR PRINTER)

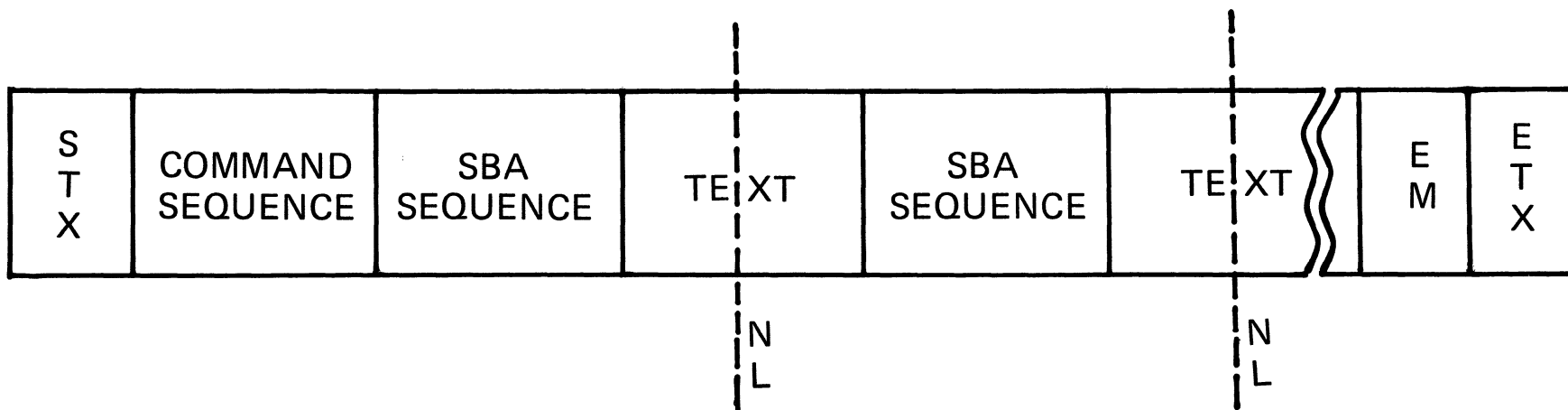

DATA FLOW TO INIATE COPY

CPU
E E
O a a 99 N
T Q
 ↑
 TO

3270
A
C Ø
K

S T X	E S C	COPY	C C C	DEVICE ADDRESS (FROM)	E T X
-------------	-------------	------	-------------	-----------------------------	-------------

OUTPUT DATA STREAM TO LOCAL PRINTER
(SAME AS DS)

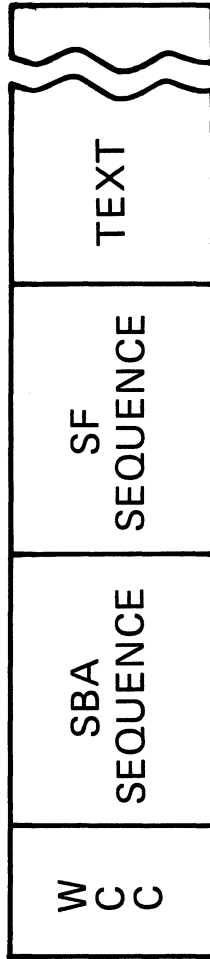

OUTPUT DATA STREAM TO LOCAL PRINTER
(FORMATTED FOR PRINTER)

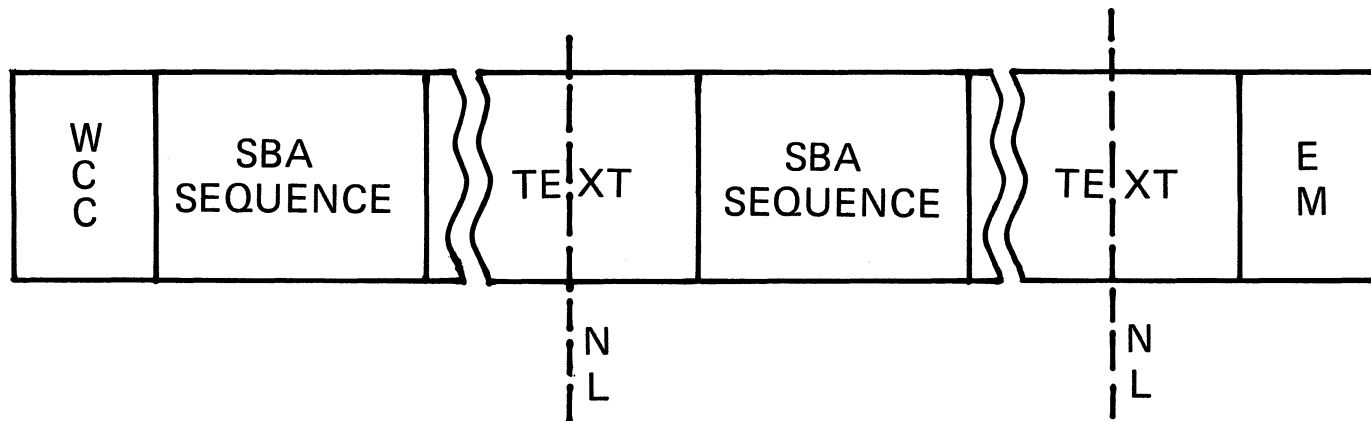

TOPIC 7 - ADDITIONAL FUNCTIONS AND FEATURES OF THE
3270 SYSTEM.

NOTE: There are additional features and functions of the 3270 which should be brought to the attention of the student. This is the purpose of this topic. Do not spend much time on any of the items.

A. Additional Orders

1. Program Tab (PT)

a. Used in Write or Erase/Write data stream.

b. Operation

1) When inserted in data stream after alphameric or null character will clear all remaining characters in existing field to nulls.

2) Advances buffer address to first alphameric character location of next unprotected field.

c. Use

Use for writing into successive data fields defined by a protected image format. This provides a means of cutting down on the amount of data which must be transmitted, especially, control characters such as the SBA sequence.

2. Duplicate (DUP)

a. An order received in the input data stream.

b. Operation

1) Generated by operator from K/B.

2) Displayed as '*'.

c. Use

Informs program to use information received in the previous record for this field. Saves the operator of keying in information which he may entered in the previous data entry operation.

3. Field Mark (FM)

- a. An order received in the input data stream.
- b. Operation
 - 1) Generated by operator from K/B.
 - 2) Displayed as ";".
- c. Use

Used as a field separator where keying in a series of variable length fields without a fixed format.

B. Operator Identification Card Reader.

- 1. Used to enter system user information.
 - a. Security
 - b. Account numbers
- 2. ID Card is 2 1/8" X 3 3/8" with a magnetically encoded stripe containing 15 characters.

TOPIC 8 - PROGRAMMING SUPPORT OVERVIEW, MAINTAINING STATUS, AND SCREEN DESIGN.

NOTE: Programming information is in Chapter 5 of GA27-2739.

A. 3270 System as a Terminal

1. OS and DOS BTAM

a. Functions Provided

- 1) Handles both remote and local systems.
 - a) Remote - part of the BTAM Support for BSC multipoint.
 - b) Local - Similar to DOS/BTAM 2260 local support.
- 2) Generates Channel programs
- 3) Starts I/O operations
- 4) Handles attentions for local and line interrupts for remote.
- 5) Provides error recovery procedures and posts error conditions.

NOTE: OS and DOS BTAM will be available with first customer shipments of the 3270 in May, 1972.

B. 3270 System as a Display Operator Console.

1. DIDOCS - Device Independent Display Operator Console Support.

- a. Provided under multiple console support option of S/360 OS-MFT & MVT.
- b. Supports locally attached display stations and printers (3272 control unit).
 - 1) 3277 DS Model 2 as a full capability console.
 - 2) 3277 DS Model 1 as an output-only console.
 - 3) 3284 and 3286 Models 1 and 2 printers as hardcopy consoles.

- c. Provides rapid entry of operator commands by support of 3270 System Program Function Keys and Selector Pen.
2. SDS-Status Display Support.
- a. Provided under OS/360 MVT and MFT.
 - b. Provides status of system devices and allows operator to monitor system activity on both DS and printers.
- C. Determining what status information must be maintained for each display station and printer.

NOTE: This subject should be covered by means of Student Exercise 7. Students should be placed in teams to work on the exercise and then the results should be reviewed in an interactive discussion between class and instructor. The major point here is that applications require the programmer to keep accurate status information on each device.

Class Exercise 7 - Determining status information
(15 min.)

D. Screen Design

NOTE: Based on the information given the students in this class, they should be able to take a particular application and format a screen or sequence of screens for that application. This is the purpose of Class Exercise 8. After the students have been given time to work on this exercise, the instructor should be able to generate a good interactive discussion on the important considerations for screen design.

Class Exercise 8 - Screen Design (30 min.)

FINAL TEST

NOTE: Time should be allowed to review the final test after all students have finished.

REFERENCES FOR STUDENT EXERCISES

Use of Codes in Data Stream

The student should use the attached list of codes to indicate what information is contained in the command, order, AID, ATTRIBUTE, WCC, and CCC codes. When a code has more than one characteristic associated with it then all of them should be indicated separated by commas. For example, if specifying an attribute byte for normal intensity and numeric, it would be written as follows:

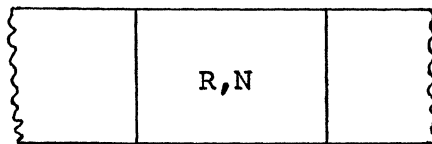

Use of Addresses in Data Stream

When an address is to be specified in the data stream, the student should use the decimal address of that location on the screen. For example, if the student wishes something to start in location 224 of the screen image it would be stated as:

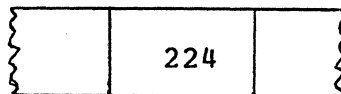

Text in Data Stream

For those fields containing text, either alphameric or numeric, simply write the characters desired, e.g.,

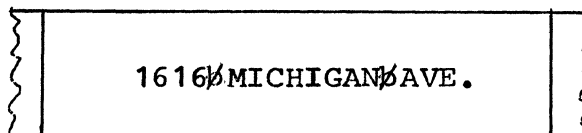

If it is necessary to specify a null in the data stream, it can be shown in the following manner:

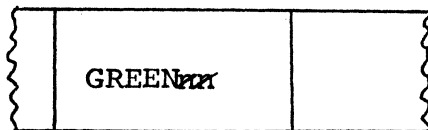

If it is necessary to specify a blank in a data stream, it can be shown as follows:

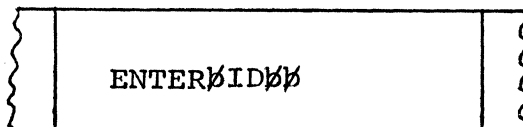

BSC Control Characters

For remote data streams indicate in the data stream where the proper binary synchronous control character would occur, e.g.:

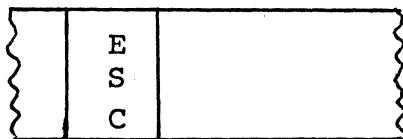

COMMANDS

CODE

EW
WR
EAU
RM
RB
CPY

COMMAND

ERASE/WRITE
WRITE
ERASE ALL UNPROTECTED
READ MODIFIED
READ BUFFER
COPY

ORDERS

CODE

SF
SBA
IC
RA
EUA
PT
NL
EM

ORDER

START FIELD
SET BUFFER ADDRESS
INSERT CURSOR
REPEAT TO ADDRESS
ERASE UNPROTECTED TO ADDRESS
PROGRAM TAB
NEW LINE
END OF MESSAGE

ATTRIBUTE CODE

CODE

U
P
N
R
H
O
S
M

CHARACTERISTICS

UNPROTECTED DATA
PROTECTED DATA
NUMERIC DATA
NORMAL INTENSITY
HIGH INTENSITY
OFF INTENSITY
SELECTOR PEN DETECTABLE
FIELD DATA TAGGED AS MODIFIED

WRITE CONTROL CHARACTER (WCC)

<u>CODE</u>	<u>DEVICE OPERATIONS</u>
WP	START PRINTER
WK	RESTORE KEYBOARD AND RESET AID
WM	RESET MODIFIED DATA TAG
WA	SOUND ALARM
WN	HONOR NL & EM CODES
WF	PRINT 40 CHARACTER LINE
WE	PRINT 80 CHARACTER LINE

COPY CONTROL CHARACTER (CCC)

<u>CODE</u>	<u>DEVICE OPERATION</u>
CP	START PRINTER
CS	COPY ENTIRE SCREEN
CX	COPY PROTECTED
CU	COPY UNPROTECTED
CA	SOUND AUDIBLE ALARM
CF	PRINT 40 CHARACTER LINE
CE	PRINT 80 CHARACTER LINE
CN	HONOR NL & EM CODES

ATTENTION ID (AID) CHARACTER

<u>CODE</u>	<u>SETTING</u>
E	ENTER KEY
C	CLEAR KEY
F	PF KEY
A	PA KEY
P	SELECTOR PEN

Student Exercise 1

The Cobra Company has its headquarters in New York City. It has offices in Philadelphia and Boston. A 3270 Information Display System is to be installed to handle data entry and inquiry applications. Display stations with 480 character image will be used for data entry and stations with 1920 character image will be used for inquiry.

New York City is the site of the CPU and requires:

- 10 - Display Stations - 480 character image
- 35 - Display Stations - 1920 character image
- 1 - 40 CPS Printer on each Control Unit

The control units in NYC will be no more than 100 feet from the CPU and all display stations and printers will be located within 750 feet of their control unit.

Philadelphia requires:

- 6 - Display Stations - 480 character image
- 4 - Display Stations - 1920 character image
- 2 - Printers @ 66 CPS each

These devices will all be located within 1500 feet of each other in Philadelphia.

Boston requires:

- 1 - Display Station - 480 character image
- 1 - Printer @ 40 CPS

These devices will be located within 10 feet of each other in Boston.

Using Appendix A and Chapter 2 in An Introduction to the IBM 3270 Information Display System (GA27-2739), list the configuration of control units, device adapters, display stations and printers at each location.

STUDENT EXERCISE 2

Remote 3270 System

A format is on the display screen for another application. Create an output data stream that will clear the screen and reset the keyboard and write out the format shown on the screen format sheet. The fields written out should be protected and normal intensity. Fields should be defined for the operator to key in name at high intensity and an ID of numerics only. ID is not to be displayed.

STUDENT EXERCISE 2

0	1	2	3	4	5	6	7	8	9	10	11	12	13	14	15	16	17	18	19	20	21	22	23	24	25	26	27	28	29	30	31	32	33	34	35	36	37	38	39			
0																																										
40																																										
80																																										
120																																										
160																																										
200																																										
240																																										
280																																										
320																																										
360																																										
400																																										
440																																										

ENTER NAME :

ID :

STUDENT EXERCISE 3

Remote 3270 System

Add to the output data stream created in Student Exercise 2 so that the display will have the information shown on the display screen format for this exercise. The cursor should be located in the first position of the first unprotected field. The additional fields should be protected and displayed at normal intensity. Cause 'CSDA', 'BTAM WORKSHOP' and '3270 O&D' to be displayed as selector pen detectable fields so that the operator may select one, several, or none of these before entering the data by means of the ENTER key.

STUDENT EXERCISE 3

	0	1	2	3	4	5	6	7	8	9	10	11	12	13	14	15	16	17	18	19	20	21	22	23	24	25	26	27	28	29	30	31	32	33	34	35	36	37	38	39		
0																																										
40																																										
80																																										
120																																										
160																																										
200																																										
240																																										
280																																										
320																																										
360																																										
400																																										
440																																										

ENTER NAME : _

SELECT CLASS

CSDA

BTAM WORKSHOP

3270 O&D

5.1.9

STUDENT EXERCISE 4

Remote 3270 System

The display screen format and output data stream for this exercise show one possible result of Student Exercise 3. Enter data on the format including selector pen detection, to reflect what you would enter as an operator. Show the input data stream that would result from a read modified command being executed when the ENTER key is depressed at the display station. Show on the format sheet the position of the cursor at the time the ENTER key is depressed. Assume the input is a single block and the source address of the input is 'B1'. Then create the output data stream that would be required to clear the variable input fields and set up the display for another enrollment transaction.

SOLUTION TO EXERCISE 3 FOR USE IN EXERCISE 4

0	1	2	3	4	5	6	7	8	9	10	11	12	13	14	15	16	17	18	19	20	21	22	23	24	25	26	27	28	29	30	31	32	33	34	35	36	37	38	39				
0																																											
40																																											
80																																											
120																																											
160																																											
200																																											
240																																											
280																																											
320																																											
360																																											
400																																											
440																																											

S T X	E S C	EW	WK	S B A	44	S F	P,R	ENTER NAME:	S F	U,H	I C	S B A	132	S F	P,R	ID:	S F	U,O,N	S B A	199
-------------	-------------	----	----	-------------	----	--------	-----	-------------	--------	-----	--------	-------------	-----	--------	-----	-----	--------	-------	-------------	-----

S F	P,R	R A	240	-	S B A	284	S F	P,R	SELECT CLASS	S B A	325	S F	P,R,S	? CSDA	S B A	342	S F	P,R,S
--------	-----	--------	-----	---	-------------	-----	--------	-----	--------------	-------------	-----	--------	-------	--------	-------------	-----	--------	-------

? BTAM	WORKSHOP	S B A	365	S F	P,R,S	? 3270	O&D	E T X
--------	----------	-------------	-----	--------	-------	--------	-----	-------------

--

5.1.11

STUDENT EXERCISE 4 – WORKSHEET

	0	1	2	3	4	5	6	7	8	9	10	11	12	13	14	15	16	17	18	19	20	21	22	23	24	25	26	27	28	29	30	31	32	33	34	35	36	37	38	39							
0																																															
40																																															
80																																															
120																																															
160																																															
200	-	-	-	-	-	-	-	-	-	-	-	-	-	-	-	-	-	-	-	-	-	-	-	-	-	-	-	-	-	-	-	-	-	-	-	-	-	-	-	-	-	-	-	-			
240																																															
280																																															
320																																															
360																																															
400																																															
440																																															

5.1.12

STUDENT EXERCISE 5

Local 3270 System

The display screen format and input and output data streams for this exercise show the results of Student Exercises 2, 3, and 4. Make the changes necessary to the input and output data streams so that they will be correct for local attachment of the display.

SOLUTION TO EXERCISE 4 FOR USE IN EXERCISE 5

	0	1	2	3	4	5	6	7	8	9	10	11	12	13	14	15	16	17	18	19	20	21	22	23	24	25	26	27	28	29	30	31	32	33	34	35	36	37	38	39						
0																																														
40																																														
80																																														
120																																														
160																																														
200																																														
240																																														
280																																														
320																																														
360																																														
400																																														
440																																														

5.1.15

INPUT DATA STREAM

S	B1	E	142	S	57	J. SMITH	S	137	23456	S	366	>3270/O&D	E	
T				A			A			A			T	
X													X	

OUTPUT DATA STREAM

S	E	WR	WK,WM	S	57	I	E	142	S	366	?	E	
T	S			A		C	U		A			T	
X	C						A					X	

STUDENT EXERCISE 6

Configuration:

		<u>Address</u>
Remote -	Control Unit	0
	Display Station	2
	Printer	9
Local -	Control Unit	1
	Display Station	1
	Printer	6

A protected display screen format for this exercise has been sent to both the local and remote displays. The operator has entered a name and an ID into unprotected fields.

Construct output data streams that will produce a hard-copy of all the displayed fields for:

- a) Remote 3270 (assume BSC selection sequence has already taken place)
- b) Local 3270

STUDENT EXERCISE 6

	0	1	2	3	4	5	6	7	8	9	10	11	12	13	14	15	16	17	18	19	20	21	22	23	24	25	26	27	28	29	30	31	32	33	34	35	36	37	38	39												
0																																																				
40																																																				
80																																																				
120																																																				
160																																																				
200	-	-	-	-	-	-	-	-	-	-	-	-	-	-	-	-	-	-	-	-	-	-	-	-	-	-	-	-	-	-	-	-	-	-	-	-	-	-	-	-	-	-	-	-	-	-	-	-	-	-		
240																																																				
280																																																				
320																																																				
360																																																				
400																																																				
440																																																				

STUDENT EXERCISE 7

The Cobra Company in Student Exercise 1 has expanded its system and added applications.

Boston is handling inquiry, source recording, and invoicing applications.

New York City and Philadelphia are handling inquiry, source recording, and data entry applications.

NYC

1 - 3272 Model 2 CU

20 - 3277 Model 2 Display Stations

5 - 3277 Model 1 Display Stations

3 - 3286 Model 2 Printers

1 - 3272 Model 2 CU

18 - 3277 Model 2 Display Stations

10 - 3277 Model 1 Display Stations

1 - 3286 Model 2 Printer

15 of the display stations have selector pens.

All the 3277 Model 2 Display Stations have data entry keyboards and all the 3277 Model 1 Display Stations have EBCDIC typewriter keyboards.

Philadelphia

1 - 3271 Model 1 CU

15 - 3277 Model 1 Display Stations

2 - 3284 Model 1 Printers

1 - 3271 Model 2 CU

5 - 3277 Model 1 Display Stations

15 - 3277 Model 2 Display Stations

2 - 3284 Model 2 Printers

1 - 3286 Model 2 Printer

All the display stations on the 3271 Model 1 CU have selector pens and EBCDIC keyboards.

All the display stations on the 3271 Model 2 CU have data entry keyboards.

Boston

- 1 - 3275 Model 2 Display Station
- 1 - 3284 Model 3 Printer

EBCDIC typewriter keyboard
Selector pen

List the variables which the programmer must consider when keeping track of the status of each device in the system. Take into account the requirement to handle multiple applications and device types.

STUDENT EXERCISE 8

The Slippery Rock Police Department is planning to install an IBM 3270 Information Display System. One of the applications they wish to implement is a stolen car inquiry system. The Police dispatcher will have a Display Station for entry to the system.

You have been asked to design one of the screen formats for this application. It is the initial screen image which will request the following detailed information to be entered by the dispatcher:

Car description including color, model, make and year.

License number and state.

The following should be considered in formatting the screen:

Display screen size.

Type of keyboard, if any.

Optional features, e.g., selector pen, audible alarm and security lock.

You should indicate the following:

Screen image format.

Characteristics of fields (attribute codes).

Means of operator entry of information, e.g., keying variable data, use of PF or PA keys, use of selector pen and ENTER key.

Without going into detail give consideration to ways for the dispatcher to obtain additional information (e.g., he may need to know the makes and models of cars that are acceptable to the system) from the system.

STUDENT EXERCISE 8

	0	1	2	3	4	5	6	7	8	9	10	11	12	13	14	15	16	17	18	19	20	21	22	23	24	25	26	27	28	29	30	31	32	33	34	35	36	37	38	39													
0																																																					
40																																																					
80																																																					
120																																																					
160																																																					
200																																																					
240																																																					
280																																																					
320																																																					
360																																																					
400																																																					
440																																																					

Student Exercise 1 Solution

The main objective of the exercise is to familiarize the student with the different Models of 3270 Control Units, display stations, and printers. There are no volume or performance considerations so the student can configure the 3270 systems in many different ways. The instructor should check the following points in particular:

1. New York City is local with at least two CU (3272). Philadelphia is remote with at least one CU (3271). Boston's requirements can be satisfied with a single 3275 Stand-alone display station.
2. Model 2 CU's are necessary if both Model 1 (480 character) and Model 2 (1920 character) DS's are to be attached.
3. The printer Model selected for a CU should be capable of handling the maximum size display also associated with that CU.
4. Printer speeds are specified, thus predetermining whether 3284 or 3286 printers are to be connected to the CU.
5. There must be a device adapter specified for every combination of four DS's or printers. They should realize that one device adapter comes with each control unit.
6. Some students will also show that a TCU (2701 or 2703) is required at NYC.

Following is an example of a typical configuration which the student might select.

New York City

<u>NO.</u>	<u>HARDWARE</u>
2	3272 Model 2 Control Units 5 additional Device Adapters on each (assuming DS's and printers split between the two CU's).
35	3277 Model 2 Display Stations with K/B (most students will probably split between CU's).

NO.

HARDWARE

- 10 3277 Model 1 Display Stations with K/B
(will probably split between CU's).
- 2 3284 Model 2 Printers (assuming both
size DS's on each CU).

Philadelphia

- 1 3271 Model 2 Control Unit
2 additional Device Adapters
- 6 3277 Model 1 Display Stations with K/B
- 4 3277 Model 2 Display Stations with K/B
- 2 3286 Model 2 Printers (assuming printer
must service both 480 and 1920 DS's)

Boston

- 1 3275 Model 1 Stand-alone Display Station
with K/B and printer adapter.
- 1 3284 Model 3 Printer.

SOLUTION TO EXERCISE 2

0	1	2	3	4	5	6	7	8	9	10	11	12	13	14	15	16	17	18	19	20	21	22	23	24	25	26	27	28	29	30	31	32	33	34	35	36	37	38	39			
0																																										
40																																										
80																																										
120																																										
160																																										
200																																										
240																																										
280																																										
320																																										
360																																										
400																																										
440																																										

S T X	E S C	EW	WK	S B A	44	S F	P,R	ENTER NAME:	S F	U,H	S B A	132	S F	P,R	ID:	S F	U,O,N	E T X	

6.1.3

Student Exercise 3 Solution

The Start Field sequence for "SELECT/CLASS" is not necessary since the sequence for the "-" is the same and will carry over until a new Start Field sequence is specified. There must be a Start Field sequence for the "-" since the previous sequence for the ID specifies non-display.

The blank character between the "?" and the selector pen detectable fields is optional and is present only for readability on the screen.

The three nulls following "CSDA" are not required since the ERASE/WRITE command clears the entire display buffer to nulls.

The final Start Field sequence controls the remainder of the screen and wraps around to control the beginning of the screen up to the first Start Field sequence.

SOLUTION TO EXERCISE 3

	0	1	2	3	4	5	6	7	8	9	10	11	12	13	14	15	16	17	18	19	20	21	22	23	24	25	26	27	28	29	30	31	32	33	34	35	36	37	38	39											
0																																																			
40																																																			
80																																																			
120																																																			
160																																																			
200	-	-	-	-	-	-	-	-	-	-	-	-	-	-	-	-	-	-	-	-	-	-	-	-	-	-	-	-	-	-	-	-	-	-	-	-	-	-	-	-	-	-	-	-	-	-	-				
240																																																			
280																																																			
320																																																			
360																																																			
400																																																			
440																																																			

S T X	E S C	EW	WK	S B A	44	S F	P,R	ENTER NAME:	S F	U,H	I C	S B A	132	S F	P,R	ID:	S F	U,O,N	S B A	199
-------------	-------------	----	----	-------------	----	--------	-----	-------------	--------	-----	--------	-------------	-----	--------	-----	-----	--------	-------	-------------	-----

S F	P,R	R A	240	-	S B A	284	S F	P,R	SELECT CLASS	S B A	325	S F	P,R,S	? CSDA	S B A	342	S F	P,R,S
--------	-----	--------	-----	---	-------------	-----	--------	-----	--------------	-------------	-----	--------	-------	--------	-------------	-----	--------	-------

? BTAM	WORKSHOP	S B A	365	S F	P,R,S	? 3270	O&D	E T X
--------	----------	-------------	-----	--------	-------	--------	-----	-------------

--

615

Student Exercise 4 Solution

The student may choose to write out the "?" for all three selector pen detectable fields to account for the operator selecting more than one course or to avoid checking which specific course was selected before restoring the screen format.

SOLUTION TO EXERCISE 4

	0	1	2	3	4	5	6	7	8	9	10	11	12	13	14	15	16	17	18	19	20	21	22	23	24	25	26	27	28	29	30	31	32	33	34	35	36	37	38	39		
0																																										
40																																										
80																																										
120																																										
160																																										
200																																										
240																																										
280																																										
320																																										
360																																										
400																																										
440																																										

INPUT DATA STREAM

S	B	E	142	S	57	J.	SMITH	S	137	23456	S	366	>	3270	O&D	E	X
T				B				B			B					T	
X				A				A			A					X	

OUTPUT DATA STREAM

S	E	WR	WK,WM	S	57	I	E	142	S	366	?	E	X
T	S			B		C	U		B			T	
X	C			A		A	A		A			X	

SOLUTION TO EXERCISE 5

	0	1	2	3	4	5	6	7	8	9	10	11	12	13	14	15	16	17	18	19	20	21	22	23	24	25	26	27	28	29	30	31	32	33	34	35	36	37	38	39												
0																																																				
40																																																				
80																																																				
120																																																				
160																																																				
200	-	-	-	-	-	-	-	-	-	-	-	-	-	-	-	-	-	-	-	-	-	-	-	-	-	-	-	-	-	-	-	-	-	-	-	-	-	-	-	-	-	-	-	-	-	-	-	-				
240																																																				
280																																																				
320																																																				
360																																																				
400																																																				
440																																																				

S	E	X	C	EW	WK	S	44	S	P,R	ENTER NAME:	S	U,H	I	S	132	S	P,R	ID:	S	U,O,N	S	199
--------------	--------------	--------------	--------------	---------------	----	---	----	---	-----	-------------	---	-----	---	---	-----	---	-----	-----	---	-------	---	-----

S	P,R	R	240	-	S	284	S	P,R	SELECT CLASS	S	325	S	P,R,S	? CSDA	S	342	S	P,R,S
---	-----	---	-----	---	---	-----	---	-----	--------------	---	-----	---	-------	--------	---	-----	---	-------

? BTAM	? WORKSHOP	S	365	S	P,R,S	? 3270	? O&D	E	X
--------	------------	---	-----	---	-------	--------	-------	--------------	--------------

6.1.8

SOLUTION TO EXERCISE 5

0	1	2	3	4	5	6	7	8	9	10	11	12	13	14	15	16	17	18	19	20	21	22	23	24	25	26	27	28	29	30	31	32	33	34	35	36	37	38	39	
0																																								
40																																								
80																																								
120																																								
160																																								
200	-----																																							
240																																								
280																																								
320																																								
360																																								
400																																								
440																																								

INPUT DATA STREAM

S	T	X	B1	E	142	S	B	A	57	J.	S	M	I	T	H	S	B	A	137	23456	S	B	A	366	>	3	2	7	0	O	&	D	E	X
--------------	--------------	--------------	----	---	-----	--------------	--------------	--------------	----	----	--------------	--------------	--------------	--------------	--------------	--------------	--------------	--------------	-----	-------	--------------	--------------	--------------	-----	---	--------------	--------------	--------------	--------------	--------------	------------------	--------------	--------------	--------------

OUTPUT DATA STREAM

S	E	W	R	WK,WM	S	B	A	57	I	E	U	142	S	B	A	366	?	E	X
--------------	--------------	--------------	--------------	-------	--------------	--------------	--------------	----	---	---	---	-----	--------------	--------------	--------------	-----	---	--------------	--------------

Student Exercise 6 Solution

For remote the preferred solution is the use of the COPY command. This does not negate the possibility of a student using a WRITE or ERASE/WRITE to the printer with a data stream for the printer.

For the local solution there may be several variations. The sample solution assumes the program sends an exact copy of the DS data stream to the printer. Some students will format the output specifically for the printer using NL and EM and eliminating none essential orders and attribute characters from the data stream. This later approach is also acceptable.

SOLUTION TO EXERCISE 6

	0	1	2	3	4	5	6	7	8	9	10	11	12	13	14	15	16	17	18	19	20	21	22	23	24	25	26	27	28	29	30	31	32	33	34	35	36	37	38	39		
0																																										
40																																										
80																																										
120																																										
160																																										
200	-	-	-	-	-	-	-	-	-	-	-	-	-	-	-	-	-	-	-	-	-	-	-	-	-	-	-	-	-	-	-	-	-	-	-	-	-	-	-	-	-	
240																																										
280																																										
320																																										
360																																										
400																																										
440																																										

REMOTE

S	E																																								
T	S	CPY	CP,CS,CF	2	E																																				
X	C				X																																				

LOCAL

WP,WF	S	44	S	P,R	ENTER	NAME	S	U,H	I	S	132	S	P,R	ID:	S	U,O,N	S	199	S	P,R	R	240	-
	B		F		∅		F		C	B		F			F		B		F		A		
	A									A							A						

6.1.11

Student Exercise 7 Solution

The following are some typical considerations that a team may list in the time allowed for this exercise:

Buffer size
Device type (Printer or DS)
Address
Unit Status - On line/off line/terminating
Number Errors in
Number Errors out
Line assignment for each unit
I/O operation in progress
Device model number
Local or remote
If printer - line width
If DS - screen size
Application program unit is linked to
Security level
Link to output queue for device
If 3275 - whether has printer attached
Type of keyboard
Terminal priority for polling & selecting
Ratio of polls to selects desired
Master or slave terminal
Flag indicating procedure to follow is a terminal has
more than a maximum number of errors.

1. Automatic removal from system
2. Operator notification

Maximum number of allowable errors

Student Exercise 8 Solution

The following are two possible student solutions to this exercise. There are many variations possible. The key areas to watch for are -

- Use of selector pen

- Use of PA and PF keys

- Split screen format for operator inquiry

SOLUTION TO STUDENT EXERCISE 8

	0	1	2	3	4	5	6	7	8	9	10	11	12	13	14	15	16	17	18	19	20	21	22	23	24	25	26	27	28	29	30	31	32	33	34	35	36	37	38	39		
0											S	T	O	L	E	N		V	E	H	I	C	L	E		I	N	Q	U	I	R	Y										
40																																										
80		<input type="checkbox"/>	1	C	O	L	O	R		<input type="checkbox"/>											<input type="checkbox"/>	1	M	O	D	E	L		<input type="checkbox"/>													
120		<input type="checkbox"/>	1	M	A	K	E		<input type="checkbox"/>												<input type="checkbox"/>	Y	E	A	R		<input type="checkbox"/>															
160		<input type="checkbox"/>	S	T	A	T	E		<input type="checkbox"/>												<input type="checkbox"/>	L	I	C	E	N	S	E		<input type="checkbox"/>												
200																																								<input type="checkbox"/>		
240	-	-	-	-	-	-	-	-	-	-	-	-	-	-	-	-	-	-	-	-	-	-	-	-	-	-	-	-	-	-	-	-	-	-	-	-	-	-	-	-		
280		S	E	L	E	C	T		C	O	L	O	R	/	M	A	K	E	/	M	O	D	E	L		F	O	R		C	O	D	E	S								
320																																										
360																																										
400																																										
440																																										

PA1 ASKS FOR INQUIRY FORMAT

COLOR, MAKE, AND MODEL ARE SELECTOR PEN DETECTABLE FOR LIST OF ACCEPTABLE CODES WHICH APPEAR ON BOTTOM HALF OF SCREEN.

TOTAL TRANSACTION ENTERED VIA ENTER KEY.

SOLUTION TO STUDENT EXERCISE 8

	0	1	2	3	4	5	6	7	8	9	10	11	12	13	14	15	16	17	18	19	20	21	22	23	24	25	26	27	28	29	30	31	32	33	34	35	36	37	38	39		
0											S	T	O	L	E	N		A	U	T	O		D	E	S	C	R	I	P	T	I	O	N									
40							M	A	K	E	:																															
80							M	O	D	E	L	:																														
120							C	O	L	O	R	:																														
160							Y	E	A	R	:																															
200							S	T	A	T	E	:																														
240							L	I	C	E	N	S	E	:																												
280	-	-	-	-	-	-	-	-	-	-	-	-	-	-	-	-	-	-	-	-	-	-	-	-	-	-	-	-	-	-	-	-	-	-	-	-	-	-	-	-	-	
320	O	P	E	R	A	T	O	R		R	E	Q	U	E	S	T	:																									
360																																										
400																																										
440																																										

ALL FIELDS PROTECTED AND NORMAL INTENSITY
 OPERATOR ENTRY IS UNPROTECTED AND HIGH INTENSITY
 OPERATOR REQUESTS THROUGH PA KEYS
 PA1 = MAKES OF CARS
 PA2 = MODELS
 PA3 = COLORS
 RESPONSE WILL PRINT OUT IN OPERATOR REQUEST AREA OF
 SCREEN.

6.1.15



READER'S COMMENT FORM

IBM 3270 Operation and Design

ZR20-4264-0

Please comment on the usefulness and readability of this publication, suggest additions and deletions, and list specific errors and omissions (give page numbers). All comments and suggestions become the property of IBM.

COMMENTS

Reply Requested

Yes

No

Name _____

Job Title _____

Address _____

_____ Zip _____

Thank you for your cooperation. No postage necessary if mailed in the U.S.A.

FOLD ON TWO LINES, STAPLE AND MAIL.

YOUR COMMENTS PLEASE

Your comments on the other side of this form will help us improve future editions of this publication. Each reply will be carefully reviewed by the persons responsible for writing and publishing this material.

Please note that requests for copies of publications and for assistance in utilizing your IBM system should be directed to your IBM representative or the IBM branch office serving your locality.

FOLD

FOLD

FIRST CLASS
PERMIT NO. 142
POUGHKEEPSIE, NEW YORK

BUSINESS REPLY MAIL

NO POSTAGE STAMP NECESSARY IF MAILED IN THE UNITED STATES

POSTAGE WILL BE PAID BY:

IBM Corporation
Education Center, Bldg. 005
South Road
Poughkeepsie, New York 12602

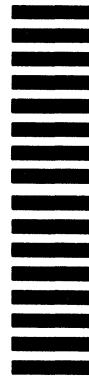

ATTENTION: Education Development - Publications Services, Dept. 78L

FOLD

FOLD



International Business Machines Corporation
Data Processing Division
1133 Westchester Avenue, White Plains, New York 10604
(U.S.A. only)

IBM World Trade Corporation
821 United Nations Plaza, New York, New York 10017
(International)