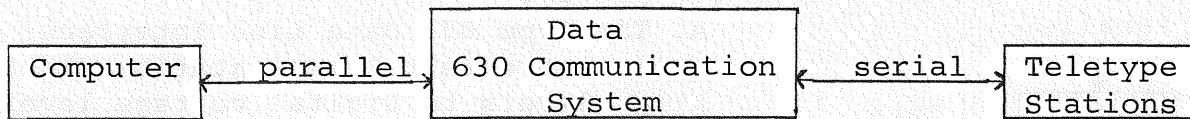

**digital****COMPUTER  
OPTIONS****630  
DATA COMMUNICATION  
SYSTEM**

The 630 Data Communication System (DCS) is a real time interface between teletype stations and a computer. It is ideal for multi-user time sharing systems, message switching systems, and data collection-processing systems. Its basic function is to receive and transmit characters.

- A. When receiving; characters of different data rates and unit codes arrive from the teletype stations in serial form.
1. The DCS converts the signals to Digital voltage levels.
  2. The characters are converted from serial to parallel form.
  3. The characters are forwarded to the computer.
- B. When transmitting; characters in parallel form are presented to the DCS by the computer.
1. The characters are converted to serial teletype form of the correct data rate and unit code.
  2. They are converted from Digital voltage levels to teletype station signal levels.
  3. They are sent to the teletype stations.

The modularity and plugability of the 630 DCS is such that very little installation time is required to expand the system from one station to the maximum number of stations. Various combinations of data rates, unit codes, station types, and station signal level can be accommodated in one 630 DCS.

There are two (2) basic types of 630 DCS. One System has a maximum interface capacity of eight (8) stations; the other has a maximum interface capacity of sixty-four (64) stations (128 pairs of wires for Full Duplex operation).

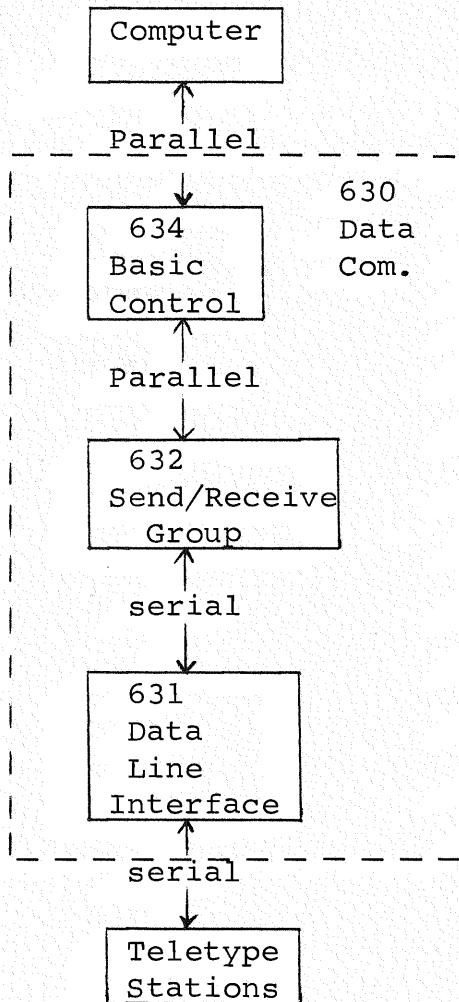

The 630 System at the left has a maximum capacity of eight (8) teletype stations Half Duplexed (8 pairs) or Full Duplexed (16 pairs).

A. The Type 631 Data Line Interface:

1. converts teletype station signal levels to Digital voltage levels.
2. converts Digital voltage levels to teletype station signal levels.

The extent of modularity of the 631 is dependent upon the type of station signals to be converted. The 631 is plug connected to the 632.

B. The Type 632 Send/Receive Group:

1. when transmitting, converts parallel characters to serial teletype characters.
2. when receiving, converts serial teletype characters to parallel characters.
3. mixes the received characters of the eight (8) teletype stations onto a buss for presentation to the 634.
4. notifies the 634 when service is required.

When a character has been received or transmitted a flag (indicator) is activated. The flag in turn notifies the 634 that service is required for that particular station. The manual off-on switch mounted on the handle of the Receiver and Transmitter modules may be turned off to inhibit the flag from requesting service.

The Type 632 can accommodate a maximum of eight (8) Receiver modules and eight (8) Transmitter modules. The quantity required is dependent upon the number of teletype stations. (If four (4) Half Duplex stations are to be interfaced, only four (4) Receiver and four (4) Transmitter modules are required). The type of each module required is dependent upon the data rate, unit code and the number of data bits. Teletype stations requiring different data rates, unit codes and data bits can be intermixed in the Type 632. The Receiver module disregards hits (noise) less than one-half ( $\frac{1}{2}$ ) of a unit in length on an idle line. The 632 is a totally pluggable unit.

C. The Type 634 Basic Control:

1. decodes and interprets computer instructions.
2. forwards received characters to the computer upon request from the computer.
3. sends characters to the Transmitter modules when instructed by the computer.
4. requests computer service when notified by the 632 that service is required.

The Type 634 contains a precision crystal-controlled clock which generates highly accurate timing pulses. The Transmitter and Receiver modules use these pulses to sample the serial teletype signals. An additional crystal clock can be added to accommodate intermixed teletype speeds.

A computer program tests each flag to determine the station requesting service. A System of eight (8) stations tends to be the practical limit for this method of station service request detection. For more than 8 stations, a high-speed built in flag scanner is recommended.

When the System is used for local in-house use, the function of the 631 may be included in the 634. The 634 is a totally pluggable unit.

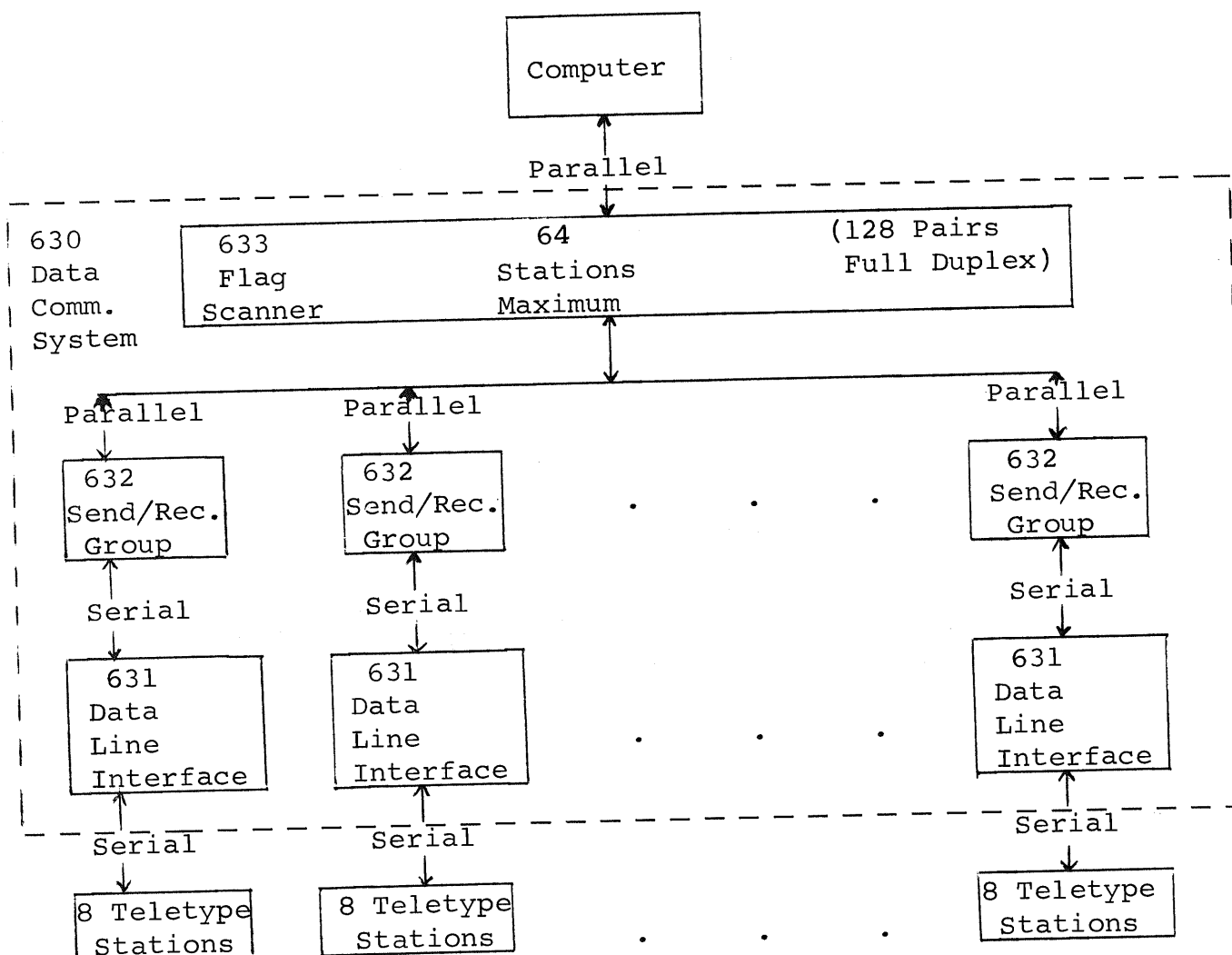

The above 630 System has a maximum capacity of eight (8) groups (8 stations per group) or 64 stations. (128 pairs of wires for Full Duplex operation).

- A. The Type 631 Data Line Interface has been previously described.
- B. The Type 632 Send/Receive Group has been previously described. References to the 634 now reflect the 633.

C. The Type 633 Flag Scanner:

1. decodes and interprets computer instructions.
2. forwards received characters to the computer upon request from the computer.
3. sends characters to the transmitter modules when instructed by the computer.
4. scans each 632 in search of activated flags.
5. notifies the computer when an activated flag has been found.
6. forwards the station number requiring service to the computer upon request from the computer.

The Type 633 contains a precision crystal-controlled clock which generates highly accurate timing pulses. The Transmitter and Receiver modules use the pulses to sample the serial teletype signals. An additional crystal clock can be added to accommodate multiple teletype speeds.

A crystal clock is also used to generate timing pulses that control the search logic of the scanner.

The scanning mechanism of the 633 is modular. Each expansion permits an additional eight (8) stations (1 group) to be scanned.

A rotating priority scanner notifies the computer when an active flag has been found. The computer program requests the station number and then handles the character. Programmed priority of the stations is permitted.

The Flag Scanner operates at very high speeds:

1. The maximum total time required to examine 64 inactive stations: 32 microseconds.

2. The maximum total time to search, notify the computer and continue search for 64 simultaneously active stations: 544 microseconds. (Exclusive of computer interrupt and programming cycles).
3. The minimum time required to find the next active station upon being released by the computer: 6 microseconds.
4. The maximum time required to find the next active station (station being serviced minus one) upon being released by the computer: 92 microseconds.

Note that in most cases, the volume of communications traffic generated with 64 teletype stations is only limited by the speed of the computer program to handle those stations and not by the speed of the DCS, Type 630.

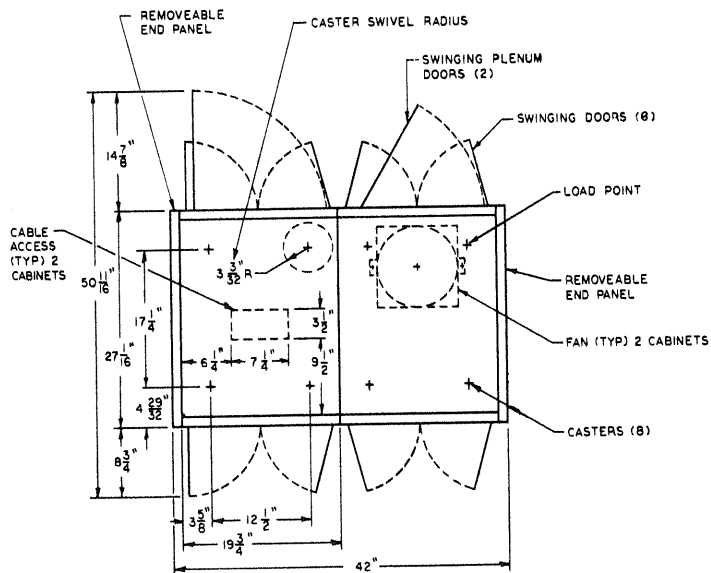

#### DIMENSIONS Cabinet

42 in. wide  
27-1/16 in. deep  
69-1/8 in. high

#### SERVICE CLEARANCE

8-3/4 in. front  
14-7/8 in. rear

#### MAXIMUM WEIGHT Cabinet

1000 pounds

#### CABLES

Enter through bottom  
cabinet port.

**digital****COMPUTER  
OPTIONS****630  
DATA COMMUNICATION  
SYSTEM**

Data Line Interface  
Type 631

1. Type 631A

This type is used to interface 60 ma. 120V telegraph signals to standard Digital logic using relays. Bias adjustment is provided to compensate for various signal conditions. The interface will operate up to 300 baud.

A maximum of eight (8) stations may be connected to each 631A. (8 pairs Half Duplex, 16 pairs Full Duplex).

The 631A is sold as a basic chassis without relays. The quantity of relays required is dependent upon the type and number of stations to be interfaced. (Half Duplex stations require one (1) receive and one (1) send relay).

2. Other types of interface are available on request.



Send/Receive Group  
Type 632

The basic Send/Receive Group contains mixers for the characters received from the eight (8) teletype stations. Also included is a mixer for the service request flags. The 632 can be used for different data rates, unit codes, and data bit characters.

Up to eight (8) Transmitter and eight (8) Receiver modules (selected from the list below) can be packaged in the Type 632.

1. 4702 Receiver module (5 bit character)
2. 4703 Transmitter module (5 bit character)
3. 4706 Receiver module (8 bit character)
4. 4707 Transmitter module (8 bit character)

Note: Each Half Duplex station requires one (1) Receive and one (1) Transmit module.

The letter associated with each Type number, keys the various components to one-another and to specific computers.

1. Half Duplex Types

- a. 632A used with 634B
- b. 632B used with 633A, 633C, 633D, 633E
- c. 632C used with 634A, 634C, 634D

2. Full Duplex Types

- a. 632D used with 634R
- b. 632E used with 634P, 634S, 634T  
633P, 633R, 633S, 633T



Flag Scanner  
Type 633

The Flag Scanner contains sufficient logic to scan one (1) group (8 stations). The 633 is equipped with a crystal clock that is used by the 632 for sampling teletype signals.

Options available:

1. clock for intermixing teletype speeds
2. group expansion (activates the other seven (7) groups, one (1) group at a time)

The Full Duplex Scanner has two (2) independent counters that scan the station service request flags (one for Receiver flags and one for Transmitter flags). There are two (2) computer service request flags (one for the Receiver counter and one for the Transmitter counter). The Full Duplex System thus permits priorities to be established between Transmitter and Receiver stations. This is a desirable feature for handling system peak loads efficiently.

The letter associated with each Type number, keys the various components to one-another and to specific computers.

1. Half Duplex Single Counter Types:
  - a. 633A used with 632B & PDP-1
  - b. 633B used with 632B & PDP-6
  - c. 633C used with 632B & PDP-4
  - d. 633D used with 632B & PDP-5
  
2. Full Duplex Dual Counter Types:
  - a. 633P used with 632E & PDP-1
  - b. 633R used with 632E & PDP-6
  - c. 633S used with 632E & PDP-4
  - d. 633T used with 632E & PDP-5

Basic Control  
Type 634

The Basic Control contains sufficient logic to handle the eight (8) stations in the 632. It is not expandable above this number. The 634 is equipped with one (1) crystal clock (used by the 632 for sampling teletype signals).

Options available:

1. clock for intermixing teletype speeds

The letter associated with each type number, keys the various components to one-another and to specific computers.

1. Half Duplex Types:

- a. 634A used with 632C & PDP-4
- b. 634B used with 632A & PDP-1 (256 Break System)
- c. 634C used with 632C & PDP-5
- d. 634D used with 632C & PDP-1

2. Full Duplex Types:

- a. 634P used with 632E & PDP-4
- b. 634R used with 632D & PDP-1 (256 Break System)
- c. 634S used with 632E & PDP-5
- d. 634T used with 632E & PDP-1

Note: When the system is used for local in-house use, the function of the 631 may be included in the 634.

OPTIONS  
Type 635

1. Type 635A Line Power Supply  
The power supply is capable of supplying current for 32 lines (at 60 ma ea). Included are series line load registers.
2. Type 635B Jack Panel  
Each jack panel contains 78 jacks. Three jacks are used for each line (1 pair). Thus 26 pairs may be connected to each jack panel. The three jacks allow station line patching, computer line patching, station line monitoring.
3. Type 635C Model 33 KSR Teletype Station Keyboard and Printer
  1. ASCII characters
  2. 74 characters/line
  3. 10 characters/inch horizontal
  4. 6 characters/inch vertical
  5. 10 eight bit characters/second
4. Type 635D Model 35 KSR Teletype Stations Keyboard and Printer
  1. ASCII characters
  2. 72 characters/line
  3. 10 characters/inch horizontal
  4. 6 characters/inch vertical
  5. Sprocket Paper feed
  6. 10 eight bit characters/second
5. Type 635E Model 33 ASR Teletype Station
  1. same Type 635C
  2. paper tape reading station
  3. paper tape punching station
6. Type 635F Model 35 ASR Teletype Station
  1. same as Type 635D
  2. paper tape reading station
  3. paper tape punching station
7. Type 635G Motor Control  
Permits remote turn-on and off of teletype station motor.



**digital****COMPUTER  
OPTIONS****630  
DATA COMMUNICATION  
SYSTEM**630 Data Communication System Prices

## A. 631 Data Line Interface

1. 631A - 60 ma. Relay Basic Chassis	750.00
a. send relay @	42.00
b. receive relay @	42.00

## B. 632 Send/Receive Group

1. 632A Basic Chassis	1500.00
632B Basic Chassis	1500.00
632C Basic Chassis	1500.00
632D Basic Chassis	1500.00
632E Basic Chassis	1500.00
a. 4702 Receiver Module 5 bit	200.00
b. 4703 Transmitter Module 5 bit	250.00
c. 4706 Receiver Module 8 bit	260.00
d. 4707 Transmitter Module 8 bit	275.00

## C. 633 Flag Scanner, Half Duplex, Single Counter

1. 633A @	7000.00
633B @	7000.00
633C @	7000.00
633D @	7000.00
a. Each Group expansion @	238.00
b. Each Clock for intermixing speeds @	364.00

## D. 633 Flag Scanner, Full Duplex, Dual Counter

1. 633P @	10.000.00
2. 633R @	10.000.00
3. 633S @	10.000.00
4. 633T @	10.000.00
a. Each group expansion @	290.00
b. Each Clock for intermixing speeds @	364.00

- 13 -

## E. 634 Basic Control, Half Duplex

1. 634A @	3000.00
2. 634B @	3000.00
3. 634C @	3000.00
4. 634D @	3000.00

a. Each Clock for intermixing  
speed @ 364.00

## F. 634 Basic Control, Full Duplex

1. 634P @	3500.00
2. 634R @	3500.00
3. 634S @	3500.00
4. 634T @	3500.00

a. Each Clock for intermixing  
speeds @ 364.00

## G. 635 Options

1. 635A Line Power @	500.00
2. 635B Jack Panel @	600.00
3. 635C Model 33 KSR	580.00
4. 635D Model 35 KSR	1920.00
5. 635E Model 33 ASR	770.00
6. 635F Model 35 ASR	3000.00
7. 635G Motor Control	

SUMMATION

Prices for a 630 Data Communication System for interfacing one (1) group (8 teletype stations) to a PDP-1 computer using:

1. 633A Half Duplex, Single Counter Scanner
2. 632B Half Duplex, Send/Receive Group
3. 631A Data Line Interface

630 DCS 1 group, 8 bit char, 11.0 unit code.10 char/sec.	14202.00
5 bit char, 7.5 unit code.10 char/sec.	13522.00

Each Additional Group 8 bit char	7440.00
5 bit char	6760.00

Not included in the above prices:

1. teletype stations and interconnecting lines
2. line power supplies
3. jack panels

Prices for the above system, for increments of one station, are given in the attached table. Prices are for 8 bit character stations. To determine the price for 5 bit character stations, reduce the price by \$85.00 for each station. For example:

16-8 bit character stations	\$21642.00
reduction for 5 bit character stations 16 x \$85.	<u>-1360.00</u>
16-5 bit character stations	\$20282.00
16-8 bit character stations	\$1352.63 per station
reduction for 5 bit character stations	<u>- 85.00</u>
16-5 bit character stations	\$1267.63 per station



Number of Stations	630 DCS Price	Number of Stations	630 DCS Price	Number of Stations	630 DCS Price	Number of Stations	630 DCS Price
1	\$ 9869.	17	\$24749.	33	\$39629.	49	\$54509.
2	10488.	18	25368.	34	40248.	50	55128.
3	11107.	19	25987.	35	40867.	51	55747.
4	11726.	20	26606.	36	41486.	52	56366.
5	12345.	21	27225.	37	42105.	53	56985.
6	12964.	22	27844.	38	42724.	54	57604.
7	13583.	23	28463.	39	43343.	55	58223.
8	14202.	24	29082.	40	43962.	56	58842.
\$/station	1775.25	\$/station	1241.75	\$/station	1099.05	\$/station	1050.75
9	17309.	25	32189.	41	47069.	57	61949.
10	17928.	26	32808.	42	47688.	58	62568.
11	18547.	27	33427.	43	48307.	59	63187.
12	19166.	28	34046.	44	48926.	60	63806.
13	19785.	29	34665.	45	49545.	61	64425.
14	20404.	30	35284.	46	50164.	62	65044.
15	21023.	31	35903.	47	50783.	63	65663.
16	21642.	32	36522.	48	51402.	64	66282.
\$/station	1352.63	\$/station	1141.31	\$/station	1070.88	\$/station	1035.66

**digital****COMPUTER  
OPTIONS****630  
DATA COMMUNICATION  
SYSTEM**

Programming the 630 Data Communication  
System Using the 634 Basic Control  
for Half Duplex

The programming operations to accomplish transmitting and receiving characters in a many station teletype communication system involves knowing when stations require servicing, being able to determine the specific station that requires servicing and transferring characters between the 630 DCS and the computer.

A. The method of receiving a character is as follows:

1. The receiver turns on a flag at the completion of receiving a teletype character.
2. The flag in turn notifies the computer that a character is assembled and that service is required. Notification may be in the form of a program interrupt, program test by check status, and/or skip test of a flag.
3. The program then determines which station has requested service by using the In-Out Skip test to check the status of each station.
4. The program then reads the character from the service requesting receiver into an input register (In-out register, Accumulator register, Core Memory register). In some Type 634 models, the incoming character may be "ORed" to the input register at the program's option. If the "OR" option is used, that portion of the input register, where the character is received, must be zero prior to read-in. Transmitter garbling may otherwise occur.

5. Reading the character will clear the receiver flag.
6. To insure that characters are not lost when receiving at maximum data rates, the program must examine the character within the following times (after service has been requested).

<u>WPM</u>	<u>Bit Code</u>	<u>Baud</u>	<u>Unit Code</u>	<u>Time</u>
60.0	5	45.5	7.5	41.0 millisec
66.6	5	50.	7.5	37.5 millisec
100.0	5	75.	7.5	25.0 millisec
100.0	8	110.	11.	21.5 millisec

If delays greater than above are experienced, the character read in will be garbled; however, the next character received will be correct. The receiver flag must be turned off (step A5) even if the program exceeds the above limits otherwise the completion of the next character cannot be determined.

B. The method of transmission is as follows:

1. The program loads the transmitter buffer of a specific station. This in itself initiates data transmission. The receiver flag is cleared by this step.
2. At completion of sending a character, the receiver flag is turned on.
3. Steps A1, A2, A3 now are executed.
4. At this point, the program has the option of executing B5, B6 or B7.
5. The receiver receives all data sent on the telegraph line; therefore, the character received may be used as an echo check on data sent. The telegraph line is the connection between the transmitter and the receiver, so if the echo matches the data sent, the programmer is certain that the data was on the telegraph lines. The program would receive a character as in steps A4 and A5 for echo checking. This may be followed by step B6.

6. The program may transmit another character. To insure maximum transmission rates, the program must reload the transmitter buffer within the following times. (After service has been requested).

<u>WPM</u>	<u>Bit Code</u>	<u>Baud</u>	<u>Unit Code</u>	<u>Time</u>
60.0	5	45.5	7.5	30.0 millisec
66.6	5	50.	7.5	27.5 millisec
100.0	5	75.	7.5	18.5 millisec
100.0	8	110.	11.0	17.0 millisec

7. The program may desire to stop transmitting. The receiver flag must be cleared. This is accomplished by reading the character which clears the receiver flag or by performing step B5 (echo check).



**digital****COMPUTER  
OPTIONS****630  
DATA COMMUNICATION  
SYSTEM**

Programming the 630 Data Communication  
System using the 633 Flag Scanner for  
Half Duplex

The programming operations to accomplish transmitting and receiving characters in a many station teletype communication system involves knowing when stations require servicing, being able to determine the specific station that requires servicing and transferring characters between the 630 DCS and the computer.

A. The method of receiving a character is as follows:

1. The receiver turns on a flag at the completion of receiving a teletype character.
2. A rotating priority type scanner using a counter is continually sampling the receiver flags. When a flag is found on, the counter stops. The number in the counter is unique to the receiver requesting service. (The number may range from 00 to 77g depending upon the number of lines connected. For discussion purposes, it is suggested that all labeling, identification, and reference to lines be in accordance with the following scheme:

There are up to 8 lines in a group; numbered 0-7 and assigned the units position of a 2 digit octal number. There are up to 8 groups in the scanner system numbered 0-7 and assigned the eights position of the 2 digit octal number. Thus line 24 is line 4 in group 2).

3. When the counter stops, a second flag (the scanner flag) is turned on. It is this flag that notifies the computer that the scanner has found a receiver that requires service. Notification may be in the form of a program interrupt, program test by check status, and/or skip test of a flag.

4. The program requests that the number contained in the counter (station number) be placed into an input register. (In-Out Register, Accumulator Register, Core Memory Register). In some Type 633 models, the line number may be "ORed" to the input register at the program's option. (The program may release the scanner at this time. Doing so will not clear the receiver flag. After one complete revolution, the scanner will find the receiver flag still on, and re-request service for the station. Thus the program may temporarily ignore a station request for service and permit the scanner to search for a station requiring higher priority service).
5. The program then reads the character from the service requesting receiver into an input register (In-out Register, Accumulator Register, Core Memory Register). In some Type 633 models, the incoming character may be "ORed" to the input register at the program's option. If the "OR" option is used, that portion of the input register, where the character is received, must be zero prior to read-in. Transmitters garbling may otherwise occur.
6. Reading the character will clear the receiver flag.
7. The scanner flag should be cleared at this time.
8. To insure that characters are not lost when receiving at maximum data rates, the programmer must examine the character within the following times (after service has been requested).

<u>WPM</u>	<u>Bit Code</u>	<u>Baud</u>	<u>Unit Code</u>	<u>Time</u>
60.0	5	45.5	7.5	41.0 millisec
66.6	5	50.	7.5	37.5 millisec
100.0	5	75.	7.5	25.0 millisec
100.0	8	110.	11.	21.5 millisec



If delays greater than above are experienced, the character read in will be garbled; however, the next character received will be correct. The receiver flag must be turned off (step A6) even if the program exceeds the above limits. Otherwise, the completion of the next character can not be determined.

B. The method of transmitting is as follows:

- (1) A send buffer is provided to initiate transmission to an idle station. The program loads the send buffer with a specific station number. The program then instructs the 633 to send the character to the station (using the send buffer to select the desired station). The associated receiver flag is cleared at this time. Note that the scanner is not released. Thus neither the position of the scanner counter nor the state of the scanner flag need be considered when initiating transmission on a line. If transmission is initiated in multiple priority levels, it is suggested that the interrupt system be disabled during the setting of the send buffer and sending the character.
- (2) At completion of sending a character the receiver flag is turned on.
- (3) Steps A1, A2, A3, A4 now are executed.
- (4) At this point, the program has the option of executing B5, B6 or B7.
- (5) The receiver receives all data sent on the telegraph line; therefore, the character received may be used as an echo check on data sent. The telegraph line is the connection between the transmitter and the receiver, so if the echo matches the data sent, the program is certain that the data was on the telegraph lines. The program would receive a character as in step A5 and A6 for echo checking. (The scanner is not released (clearing of scanner flag) at this point unless action of B7 is desired). This may be followed by step B6.

- (6) The program may transmit another character. Note that the scanner counter is used, the scanner is released and the receiver flag is cleared. To insure maximum transmission rates, the program must reload the transmitter buffer within the following times. (After service has been requested).

<u>WPM</u>	<u>Bit Code</u>	<u>Baud</u>	<u>Unit Code</u>	<u>Time</u>
60.0	5	45.5	7.5	30.0 millisec
66.6	5	50.0	7.5	27.5 millisec
100.0	5	75.0	7.5	18.5 millisec
100.0	8	110.0	11.0	17.0 millisec

- (7) The program may desire to stop transmitting. The receiver and scanner flags must be cleared. This is accomplished by reading the character which clears the receiver flag or by performing step B5 (echo check) and releasing scanner. (Same as A5, A6, A7).

**digital****COMPUTER  
OPTIONS****630  
DATA COMMUNICATION  
SYSTEM**GENERAL INFORMATION

1. There are programming techniques which implement operator intervention and control such as:
  - a. If the echo check feature is utilized in the program, the teletype operator may signal the program while the computer is typing out. To accomplish this, the operator pushes a random key, this action causes an echo check in the computer program. The program then waits for instructions from the operator, and if none are received, resends the failed character.
  - b. The null/idle character in the 8 bit code may be distinguished from the character produced when the break key is pushed by examining the eighth (most significant) bit (1 equals null, 0 equals break providing parity is not being generated). A large number of break characters would be interpreted by the program as an open line.  
  
Open lines may be detected by a series of blank characters in the 5 bit code.
2. The program must determine by a program switch which state the line is in (transmitting or receiving).
3. A turn around restriction is applied to the program, i.e. when a character is received from the teletype station (not echo test) the program must delay before sending a return character to the teletype station. The delay is calculated by the program and varies according to data rates. The delays are:

<u>WPM</u>	<u>Bit Code</u>	<u>Baud</u>	<u>Unit Code</u>	<u>Delay</u>
60.0	5	45.5	7.5	41.0 millisec
66.6	5	50.	7.5	37.5 millisec
100.0	5	75.	7.5	25.0 millisec
100.0	8	110.	11.	21.5 millisec

4. An option is available (no charge and is installed unless instructed not to) that eliminates the need for turn around time calculation, however, it does slow down the data rates during all program transmissions. When a character is received on a line, the transmitter buffer may be loaded immediately. The transmitter will send the character when the proper stop time elapsed. The 8 bit code is slowed by 2.3% and the 5 bit code is slowed by 6.7%. The table in B6 is revised as follows:

<u>WPM</u>		<u>Bit Code</u>	<u>Unit Code</u>	<u>Time</u>	
<u>From</u>	<u>to</u>			<u>From</u>	<u>To</u>
60.0	56.0	5	7.5	30.0	41.0
66.6	62.2	5	7.5	27.5	37.5
100.0	93.3	5	7.5	18.5	25.0
100.0	97.7	8	11.0	17.0	21.5

**digital****COMPUTER  
OPTIONS****630  
DATA COMMUNICATION  
SYSTEM**INSTRUCTIONS FOR 633A  
HALF DUPLEX PDP1

1. The 630 Data Communication System is assigned 1 basic IOT instruction octal code 720022. (Bits 0-17).
2. The basic instruction is micro-programmed to form a set of useful computer instructions for operating the DCS. Adding or "OR"ing 2000g to the octal equivalent will cause the IO to be cleared before the operation is executed.
3. The following instructions control the scanner, the teletype transmitters and teletype receivers. For convenience, bit configurations are assigned mnemonics as follows:

<u>Symbolic Instruction</u>	<u>Octal Equivalent</u>	<u>Operation</u>
RCH	720022	<ol style="list-style-type: none"> <li>1. Receive a character to IO 10-17 (8 bit) (13-17, 5 bit) using the receiver counter.</li> <li>2. The "OR" function occurs</li> <li>3. Clear the receiver flag</li> <li>4. IO Bits 10-17 must be zero prior to operation execution.</li> </ol>
RCR	721022	<ol style="list-style-type: none"> <li>1. Same as RCH</li> <li>2. CLEAR THE Scanner flag (release the scanner)</li> </ol>
TCC	725022	<ol style="list-style-type: none"> <li>1. Transmit a character using the receiver counter (IO 10-17, 8 bit; IO 13-17, 5 bit, to the transmitter)</li> <li>2. Clear the receiver flag</li> <li>3. Clear the scanner flag (release the scanner)</li> </ol>
TCB	724022	<ol style="list-style-type: none"> <li>1. Transmit a character using the send buffer (IO 10-17, 8 bit; IO 13-17, 5 bit, to the transmitter)</li> <li>2. Clear the receiver flag</li> </ol>
RRC	720122	<ol style="list-style-type: none"> <li>1. Read the receiver counter (counter to IO 12-17)</li> <li>2. The "OR" function occurs</li> </ol>
SSB	724122	<ol style="list-style-type: none"> <li>1. Set the send buffer (IO 12-17 to send buffer)</li> <li>2. Used to select an idle station for transmission</li> </ol>
RSC	721122	<ol style="list-style-type: none"> <li>1. Clear the scanner flag (release the scanner)</li> </ol>

4. The state of the Scanner Flag may be read into the IO register bit 16, using the check status instruction (1 = flag on).
5. Initialization procedures must at least include clearing of the scanner flag. (Actually all receiver flags should be cleared.)
6. The priority level to which the scanner flag is assigned is dependent upon the equipment configuration of your system.

**digital****COMPUTER  
OPTIONS****630  
DATA COMMUNICATION  
SYSTEM**INSTRUCTIONS FOR THE 633B  
HALF DUPLEX PDP6

1. The 630 Data Communications System is assigned 2 I/O device numbers 300 (DCSA), 304 (DCSB) (XXX XXX X). These fit into the I/O instruction as follows:

	0 - 2	3 - 8	9	10 - 11	12	13	35
DCSA	7	30	0	Y	Y		E
DCSB	7	30	4	Y	Y		E

2. YY is defined as follows:

I/O instruction	
Mnemonic	YY
DATAI	04
DATAO	14
CONO	20
CONI	24

3. Data Communication System Control. In the following instruction descriptions, E is defined as the effective address. The notation; C(E) means the contents of the effective address.

Octal Operation	Symbolic Operation	Function
0 ——— 12   13 - 35   73020                      E	CONO, DCSA, E	The Priority interrupt channel defined by bits 33-35 of E is assigned to the Data Communication System. The Scanner will be released if bit 32 is zero. (Programmed Station Priority).
73024                      E	CONI, DCSA, E	The previously assigned priority interrupt channel will be read into the C(E) bits 33-35. The state of the scanner flag will be read into C(E) bit 32 (1 = on or active). The C(E) bits 0-31 will be cleared.



73004	E	DATAI, DCSA, E	The character in the receiver (as specified by the receiver counter) is read into bits 28-35 of C(E). The C(E) bits 0-27 will be cleared; the receiver flag is turned off. The scanner and/or scanner flag are not affected by this instruction.
73014	E	DATAO, DCSA, E	The transmitter (as specified by the SEND BUFFER) is loaded from bits 28-35 of C(E). The receiver flag is turned off.
73060		CONO, DCSB, E	The send buffer is loaded from bits 30-35 of E (used to select a transmitter on an idle line).
73064	E	CONI, DCSB, E	The line number in the receiver counter is read into bits 30-35 of C(E). The C(E) bits 0-29 will be cleared.
73044	E	DATAI, DCSB, E	The character in the receiver (as specified by the receiver counter) is read into bits 28-35 of C(E). The C(E) bits 0-27 are cleared. The receiver flag is turned off, the scanner flag is turned off and the scanner is released.
73054	E	DATAO, DCSB, E	The transmitter (as specified by the RECEIVER COUNTER) is loaded from bits 28-35 of C(E). The receiver flag is turned off, the scanner flag is turned off, and the scanner is released.

**digital****COMPUTER  
OPTIONS****630  
DATA COMMUNICATION  
SYSTEM**INSTRUCTIONS FOR 634A  
HALF DUPLEX PDP4

1. The 630 Data Communication System is assigned 1 basic IOT instruction 703000 (bits 0-17).
2. The basic IOT instruction is micro-programmed.
3. The following bit definitions (contained in the IOT instruction) control the teletype transmitters and receivers.

Bit 17 = 1 -- skip if the receiver flag is off

Bit 15 = 1 -- turn the receiver flag off, gate the contents of AC 10-17 to the transmitter (8 bit code) (AC 13-17 for 5 bit code) (one's transfer)

- a. 12 = 1 - start transmitter
- b. 12 = 0 - gate receiver to AC 10-17 (8 bit code) (AC 13-17 for 5 bit code) (one's transfer)

Bit 14 = 1 -- CLEAR AC (Permits "OR" option when 0 on receiving)

Bit 12 = 1 -- TRANSMIT (15 = 1)

Bit 12 = 0 -- RECEIVER (15 = 1)

Bits 13, 4, 5 (representing an octal digit) select the desired station (0 - 7). (If bits 13 and 5 are 1; station 5 is selected, if bits 4 and 5 are 1; station 3 is selected).

4. For convenience of programmers, certain bit configurations are assigned mnemonics as follows:

TTF 703001 skip if the selected station flag is off

TTT 703044 transmit on the selected station

TTR 703014 receive character from the selected station

5. The OR conditions of all eight receiver flags may be read into the AC using the check status IOT. If any of the receiver flags are on, Bit 14 of the AC will be set to 1.
6. If any of the receiver flags are on, a program interrupt request is initiated, providing the switch at the end of the module is up.

**digital****COMPUTER  
OPTIONS****630  
DATA COMMUNICATION  
SYSTEM**INSTRUCTIONS FOR 634C  
HALF DUPLEX PDP5

1. The 630 Data Communication System is assigned 8 basic IOT instructions; octal code 64YØ (Y = Ø-7) (Bits Ø-11).
2. The basic IOT instruction is micro-programmed.
3. The following bit definitions (contained in the IOT instruction) control the teletype transmitters and receivers.
  - \* Bit 1Ø = 1 -- skip if the receiver flag is off.
  - Bit 9 = 1 -- turn the receiver flag off, gate the contents of AC 3-11 to the transmitter (8 bit code) (AC 7-11 for 5 bit code) (one's transfer).
    - a. 11 = 0 - start transmitter
    - b. 11 = 1 - clear the AC, gate receiver character to AC 3-11 (8 bit code) (AC 7-11 for 5 bit code)
  - Bit 11 = Ø -- Transmit (9 = 1)
  - Bit 11 = 1 -- Receive (9 = 1)
  - Bits 6,7,8 -- (Representing an octal digit Y) select the desired station (Ø-7) (if bits 6 and 8 are 1, station 5 is selected; if bits 7 and 8 are 1; station 3 is selected).
4. For convenience, certain bit configurations are assigned mnemonics as follows:
  - TTF 64Y2 skip if the select station receiver flag is off.
  - TTT 64Y4 transmit to the selected station.
  - TTR 64Y5 receive character from the selected station.

5. If any of the receiver flags are on, a program interrupt request is initiated, (providing the switch at the end of the module is up).

**digital****COMPUTER  
OPTIONS****630  
DATA COMMUNICATION  
SYSTEM**Typical 630 DCS Problems

1. It is required to interface thirty-two (32) Half Duplex, 8 bit character, 60 ma, 100 WPM teletype stations to the PDP6.

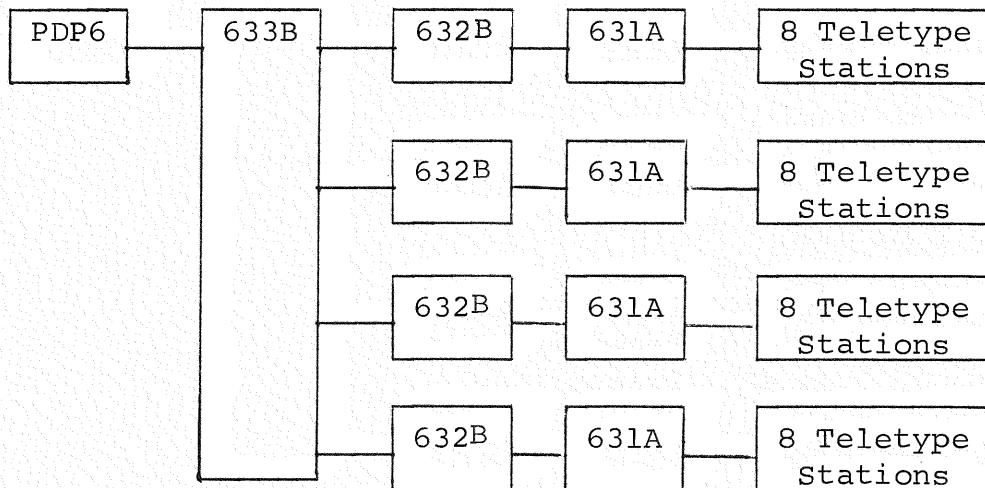

## Equipment needed:

- A. 1 ea 633B
  - 1. 3 ea group extension
- B. 4 ea 632B
  - 1. 32 ea 4706 Receivers
  - 2. 32 ea 4707 Transmitters
- C. 4 ea 631A
  - 1. 32 ea Receive Relay
  - 2. 32 ea Send Relay

2. It is required to interface six (6) Half Duplex, 100 WPM, 8 bit character and one (1) Half Duplex, 60 WPM, 5 bit character stations to the PDP4. All stations require 60 ma. and no future expansion above 8 stations is desired.

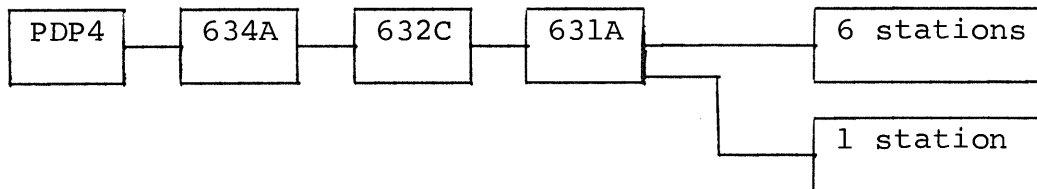

Equipment needed:

- A. 1 ea 634A
  - 1. 1 ea clock for intermixing speeds
- B. 1 ea 632C
  - 1. 6 ea 4706 Receivers
  - 2. 6 ea 4707 Transmitters
  - 3. 1 ea 4702 Receiver
  - 4. 1 ea 4703 Transmitter
- C. 1 ea 631A
  - 1. 7 ea Send Relay
  - 2. 7 ea Receive Relay



**digital****COMPUTER  
OPTIONS****630  
DATA COMMUNICATION  
SYSTEM**Typical Applications

The 630 is playing an important role in the following installations.

- (1) Data Collection System at KEYDATA Corp., Boston, Mass.

Interface to seven (7) teletype stations and one (1) TWX station.

- (2) Time Sharing System at Systems Development Corp., Santa Monica, Cal.

Interface to twenty-four (24) teletype stations and six (6) Data Sets for TWX service (Datamation Feb. '64).

- (3) Medical Communication System at Bolt, Beranek and Newman, Cambridge, Mass.

Interface to thirty-two (32) teletype stations.

## Station Arrangements

### 1. Full Duplex Station

- a. two-way simultaneous operation
- b. 2 pairs
- c. 4 wires

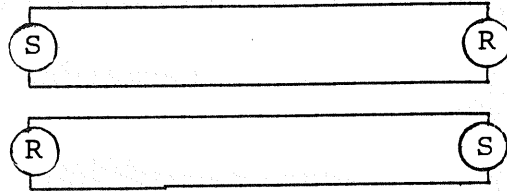

### 2. Half Duplex Station

- a. two-way non-simultaneous operation
- b. 1 pair
- c. 2 wires

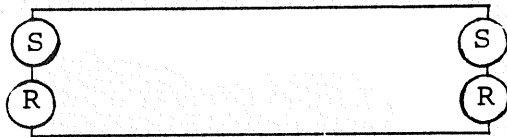

### 3. One Way Station

- a. one way operation
- b. 1 pair
- c. 2 wires

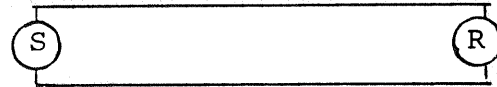

- d. When describing one way stations the function must be included.
  1. The remote station is send only.
  2. The 630 DCS interface is receive only.
- e. The statement: "The 630 DCS is interfaced to a send only station!" is confusing and should be avoided.

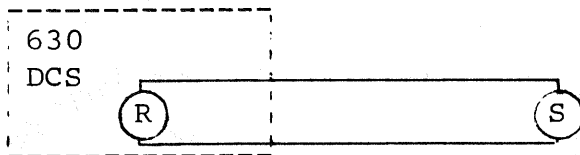

4. (S) Sending station
  - a. reader
  - b. keyboard
  - c. relay contacts
  - d. signal generator
5. (R) Receiving station
  - a. printer
  - b. punch
  - c. relay coil
  - d. signal detector

**digital****COMPUTER  
OPTIONS****630  
DATA COMMUNICATION  
SYSTEM**AMERICAN STANDARD CODE FOR INFORMATION INTERCHANGE  
(ASCII)EXAMPLE: T = 124<sub>8</sub> (ASCII), 324<sub>8</sub> Teletype Code

	0	1	2	3	4	5	6	7
00	NULL	SOM	EOA	EOM	EOT	WRU	RU	BELL
01	FE∅	HT/SK	LF	V TAB	FF	CR	SO	SI
02	DC∅	DC1	DC2	DC3	DC4	ERR	SYNC	LEM
03	S∅	S1	S2	S3	S4	S5	S6	S7
04	SPACE	!	"	#	\$	%	&	' (APOS)
05	(	)	*	+	COMMA	-	.	/
06	∅	1	2	3	4	5	6	7
07	8	9	:	;	<	=	>	?
10	@	A	B	C	D	E	F	G
11	H	I	J	K	L	M	N	O
12	P	Q	R	S	T	U	V	W
13	X	Y	Z	=	\	—	↑	←
14	←		unassigned					→
15	←		unassigned					→
16	←		unassigned					→
17	←		unassigned	ACK	①	ESC	DEL	





## LEGEND

NULL	Null/Idle	DC∅	Device control Reserved for Data Linc Escape
SOM	Start of message	DC1-DC3	Device Control
EOA	End of address	DC4	Device Control (stop)
EOM	End of message	ERR	Error
EOT	End of transmission	SYNC	Synchronous idle
WRU	"Who are you?"	LEM	Logical end of media
RU	"Are you ...?"	S∅-S7	Separator (information) (data delimiters) (words, groups, records, files, etc.)
BELL	Audible signal	SPACE	Word separator (normally non-printing)
FE	Format effector	<	Less than
HT	Horizontal tabulation	>	Greater than
SK	Skip (punched card)	↑	Up arrow (Exponentiation)
LF	Line feed	←	Left arrow (Implies/Replaced by)
V TAB	Vertical tabulation	\	Reverse slant
FF	Form feed	ACK	Acknowledge
CR	Carriage return	①	Unassigned control
SO	Shift out	ESC	Escape
SI	Shift in	DEL	Delete/Idle/Rub Out

Considerations when using the Model 33

1. The Model 33 generates an 8 bit code. The most significant bit being a 1. (This bit may later be used for even parity). For the present, 200g must be added to the ASCII code, as shown in the table, to determine the octal character representation.
2. The standard number of characters per line is 72.
3. The model 33 can generate all assigned codes except 374 and 376. Codes 207, 212, 215, 240-337 and 377 are generally sufficient for model 33 operation. The model 33 does not recognize all the codes that it can generate nor are special keys available to generate all the codes. The attached sheet shows the key combinations required to generate octal codes from 200 to 337, 375 and 377.
4. The proper sequence for proceeding to the next line is: Carriage Return, Line Feed as opposed to Line Feed, Carriage Return.

GENERATION OF OCTAL CODES ON MODEL 33

<u>Key Combinations</u>			<u>Individual or Labeled Keys</u>	<u>Resulting OCTAL CODE</u>	<u>ASCII</u>
Shift	Control	@		200	NULL/IDLE
	"	A		201	SOM
	"	B		202	EOA
	"	C		203	EOM
	"	D	(EOT)	204	EOT
	"	E	(WRU)	205	WRU
	"	F	(RU)	206	RU
	"	G	(BELL)	207	BELL
	"	H		210	FE
	"	I	(TAB)	211	HT
	"	J	(Line Feed)	212	LF
	"	K	(V TAB)	213	V TAB
	"	L	(FORM)	214	FF
	"	M	(Carriage Return)	215	CR
	"	N		216	SO
	"	O		217	SI
	"	P		220	DCØ
	"	Q	(X ON)	221	DC1
	"	R	(TAPE)	222	DC2
	"	S	(X OFF)	223	DC3
	"	T	(NOT TAPE)	224	DC4
	"	U		225	ERR
	"	V		226	SYNC
	"	W		227	LEM
	"	X		230	SØ
	"	Y		231	S1
	"	Z		232	S2
Shift	"	K		233	S3
"	"	L		234	S4
"	"	M		235	S5
"	"	N		236	S6
"	"	O		237	S7
			All Shown	240-332	GRAPHICS
Shift		K		333	
"		L		334	
"		M		335	
"		N		336	
"		O		337	
NOT AVAILABLE				340-374	
			Alternate Mode	375	Ⓛ
NOT AVAILABLE				376	
			Rub Out	377	DEL

