

CONTENTS

INDEX

PERFORMANCE SPECIFICATION

1.0 Boot Straps

2.0 Programs

A. PACK

B. NEW

C. COPY

D. CALL

E. SET

F. MTLD

G. DPTT

H. LPFT

INTRODUCTION

The function of the AUTOMATIC LOAD and DUMP (ALD) is to load 8092B core from magnetic tape or dump 8092B core to a magnetic tape.

When programs or files are being transferred from magnetic tape and 8092B core, the transferring of the words is done by banks and will always start with the word zero of bank zero. The banks will be in consecutive order until either the end of file mark is detected from the magnetic tape, or the last bank (which was indicated for the dumping of the 8092B core) has been reached. The transfer shall not exceed 14 banks of core.

ALD will have the following capabilities:

1. Set up a library of programs or files on the magnetic tapes. Up to 15 files (17 octal) may be recorded on one magnetic tape.
2. Update specific programs or files on the magnetic tape.
3. Add new programs or files to the magnetic tape.
4. Call specific programs or files to be loaded into 8092B core from the magnetic tape.
5. Verify the accuracy of transfers between the magnetic tape and 8092B core.

1. Boot Strap

The first file on tape is the boot strap, which has three records.

- A. Record one, BOOTAH and BOOTA
- B. Record two, BOOTBH and BOOTB
- C. Record three, BOOTCH and BOOTC

1.0 BOOT STRAP

A. BOOTAH, BOOTA

The first 45 frames of this record are 6 bit words making up program BOOTAH. The remaining frames of this record are 4-bit words.

When loaded into core this record has the following capability:

The first 45 locations become a program of 6-bit instructions which when executed, assembles an 8-bit program called BOOTA. BOOTA is then executed and assembles the balance of the record, (which are programs COPY and CALL) and stores them in bank 13 starting with word zero.

B. BOOTBH, BOOTB

The first 45 frames of this record are 6-bit words making up program BOOTBH. The remaining frames of this record are 4-bit words.

When loaded into core this record has the following capability:

The first 45 locations become a program of 6-bit instructions which when executed, assembles an 8-bit program called BOOTB. BOOTB is then executed and assembles the balance of the record, (which are programs SET and MTLD) and stores them in bank 14 starting with word zero.

C. BOOTCH, BOOTC

The first 45 frames of this record are 6-bit words making up program BOOTCH. The remaining frames of this record are 4-bit words.

When loaded into core this record has the following capability:

The first 45 locations become a program of 6-bit instructions which when executed, assembles an 8-bit program called BOOTC. BOOTC is then executed and assembles the balance of the record, (which are programs LPFT and DPTT) and stores them in bank 15 starting with word zero.

2. Program

The following descriptions are for the programs which run in the 8090, or the 160A computer:

A. PACK

This program will generate the boot strap for the Automatic Load and Dump Tape for the 8092 Computer.

Its function is to write three magnetic tape records, end of file mark and code mark (octal 77) in binary and low density. It checks for errors after each record.

The records in this file are:

Record 1 = BOOTAH and BOOTA

Record 2 = BOOTBH and BOOTB

Record 3 = BOOTCH and BOOTC

B. NEW

Its function is to add a new file onto the "Magnetic Automatic Load and Dump Tape".

When programs for the 8092B Teleprogrammer have been assembled by OSAS-A, the binary paper tape output may be loaded into the 8090 or the 160A computer, transferred to the "Magnetic Automatic Load and Dump Tape". The routine will assign a file number to show the file location on the "Magnetic Automatic Load and Dump Tape".

Continuation

These are the programs which run in the 8092B Teleprogrammer

C. COPY

This program copies the first file from AUTOMATIC LOAD and DUMP TAPE. This file is the BOOT STRAP. (The BOOT STRAP is not considered as a file number on this tape.) There are three records to this file.

Record 1 is known as BOOTAH and BOOTA

Record 2 is known as BOOTBH and BOOTB

Record 3 is known as BOOTCH and BOOTC

COPY can output records 1, 2, and 3 on the new tape, write end of file mark, and code mark (an octal 77) which identifies the last file on the AUTOMATIC LOAD and DUMP TAPE.

D. CALL

This program loads the 8092B core starting with word zero of bank zero with the remaining two records of the BOOT STRAP file.

Record one of this file is loaded by the Teleprogrammers load and run switches. When record one is assembled program CALL is stored into bank 13.

CALL will then load 8092B core with record two of the file. Record two is then assembled and stores its programs in bank 14. Record three of the file is then loaded, assembled, and stores its programs in bank 15. CALL then comes to a halt.

Programs are now loaded in their proper banks and ready to perform any job assignment such as:

Dumping 8092B core to the Automatic Load and Dump Tape.

Loading 8092B core from Automatic Load and Dump Tape.

Copying the Boot Strap from the Automatic Load and Dump Tape on a new Automatic Load and Dump Tape.

E. SET

This program checks for the job assignment. If the job assignment is dumping SET will: a) determine if file to be dumped updates an existing

Continuation

file and set up the number of the file to be updated b) determine if the file to be dumped is a new file to be added to the tape.

If the job assignment is loading, SET will determine the number of the file on magnetic tape to be loaded. SET will initialize all control words, fix program MTL D to either read or write, and exit to programs LPFT or DPTT depending on the job assignment.

F. MTL D

This program will read or write in binary and low density variable length records up to 102 characters over the normal channel. The characters are read into or written from a common input/output area. It checks for parity errors after each record transfer, if an error exists, it will try five times for that record. If the error persists MTL D will come to a halt to indicate the error. When dumping 8092B core on the Automatic Load and Dump Tape the file number will be displayed after completion of the dump in the A register.

When loading a file from the Automatic Load and Dump Tape into the 8092B core, MTL D will compare check sums for the verification of the loading. When complete file is loaded MTL D will come to a halt. The contents of the A register will display the following:

Zero in the A register, the file was loaded correctly

Non Zero in the A register, the file was loaded incorrectly.

G. DPTT

This program prepares the 8092B core for output to the Automatic Load and Dump Tape starting with word zero of bank zero.

Each word to be outputted is added to a check sum counter and then processed as follows:

The word is divided into two 4-bit words with the high order 4-bits being identified. The two 4-bit words are then stored into the input/output area. When the input/output area has reached 102 words, DPTT releases control to MTL D.

Continuation

After processing the last word, the check sum is processed in the same manner. The check sum then becomes the last two words of this record, which will be less than 102 words.

H. LPFT

This program assembles the words in the input/output area which were inputted by the Program MTL D from the Automatic Load and Dump Tape.

The input/output area is filled with 4-bit words.

Two 4-bit words are combined to one eight bit word, checksummed, then stored in 8092B core starting with word zero of bank zero, the store address is then incremented by one. When the storing is completed, LPFT releases control to MTL D. This process will continue until MTL D detects an end of file mark on the Automatic Load and Dump Tape.

OPERATIONAL SPECIFICATION
MAGNETIC "AUTOMATIC LOAD AND DUMP TAPE"
FOR THE
8090 OR THE 160-A COMPUTER

INDEX

1. HARDWARE REQUIRED
2. RESTRICTIONS
3. GENERATE A MAGNETIC "AUTOMATIC LOAD AND DUMP TAPE"
4. ADD A FILE TO THE MAGNETIC "AUTOMATIC LOAD AND DUMP TAPE".

I. HARDWARE REQUIRED

- A. The 8090 computer with a 603 Tape Drive using the 8071 synchronizer, or the 160A computer with a 603 Tape Drive using the 162 synchronizer.

2. RESTRICTIONS

- A. When a new file is to be added to the magnetic "Automatic Load and Dump Tape", the starting point for the output will always be memory location zero, and will be by multiples of 400 memory locations.
- B. The dumping of the new file should not exceed memory location (7000).

3. GENERATE A MAGNETIC "AUTOMATIC LOAD AND DUMP TAPE"

- a. Mount the magnetic tape that is to be an "Automatic Load and Dump Tape" on tape drive 3. Set tape drive 3 to LOW DENSITY and in a ready state with the magnetic tape at LOAD point.
- b. MASTER CLEAR computer, and ZERO out memory locations.
- c. Turn the paper tape reader on, set to read in 7 level paper tape. Put the paper tape that is marked "PACK" into the paper tape reader. Enter manually "⁷²⁷⁰7300" in the P-REGISTER. Put the LOAD switch into the up position, then the RUN switch into the up position. The computer will come to a halt with the following information in the REGISTERS:

P = 7715, A = 0000, Z = 0000

Return the RUN and LOAD switches to the normal (center) position.

- d. MASTER CLEAR computer
Enter, manually "⁷²⁷⁰~~7300~~" in the P-REGISTER. Put the RUN switch into the up position. The computer will come to a halt with the following information in the REGISTERS:

P = 7543, A = 0000, Z = 7700

Return the RUN switch to the normal (center) position.

- e. MASTER CLEAR computer
Enter, manually "⁷²⁷⁰~~7300~~" in the P-REGISTER. Put the RUN switch into the up position. The computer will come to a halt with the following information in the REGISTERS:

P = 7543, A = 0000, Z = 7700

Return the RUN switch to the normal (center) position.

f. MASTER CLEAR computer.

Entry, manually "7000" in the P-REGISTER. Put the RUN switch into the up position. The computer will come to a halt with the following information in the REGISTERS:

P = 7244, A = _____, Z = 7700

Return the RUN switch to the normal (center) position.

g. The magnetic tape on tape 3 is now a magnetic "Automatic Load and Dump Tape". The only file on the tape is the BOOT-STRAP, which is a self storing program.

h. ERROR STOPS

Return the RUN switch to the normal (center) position.

1. P = 7116, A = 0002, Z = 7700

REASON: Tape Drive 3 is not ready.

RECOVERY: Correct the condition of tape drive 3. Put the RUN switch into the up position.

2. P = 7160, A = 7777, Z = 7700

REASON: Parity error detected on five successive attempts to write.

RECOVERY: Restart with step 3a (above), and use a different magnetic tape in step 3a.

I. If the computer stops and none of the error stops described above appear, restart beginning at step 3a (above).

4. ADD A FILE TO THE MAGNETIC "AUTOMATIC LOAD AND DUMP TAPE".

- a. Mount the magnetic "Automatic Load and Dump Tape" on tape drive 3. Set tape drive 3 to LOW DENSITY and in a ready state with the magnetic tape at LOAD point.
- b. MASTER CLEAR computer, and ZERO out memory locations.
- c. Turn the paper tape reader on, set to read in 7 level paper tape. Put the paper tape that is marked NEW into the paper tape reader. Enter, manually ⁷²⁷⁰"~~7300~~" in the P-REGISTER. Put the LOAD switch into the up position, then the RUN switch into the up position. The computer will come to a halt with the following information in the REGISTERS:

P = 7715, A = 0000, Z = 0000

Return the LOAD and RUN switches to the normal (center) position.

- d. MASTER CLEAR computer

Enter, manually ⁷²⁷⁰"~~7300~~" in the P-REGISTER. Put the RUN switch into the up position. The computer will come to a halt with the following information in the REGISTERS:

P = 7543, A = 0000, Z = 77000

Return the RUN switch to the normal (center) position.

- e. Remove the paper tape (NEW) from the paper tape reader. Insert the binary paper tape which was created by the OSAS-A assembly in the paper tape reader. Enter, manually ⁷²⁷⁰"~~7300~~" in the P-REGISTER. Put the RUN switch into the up position. The computer will come to a halt with the following information in the REGISTERS:

P = 7543, A = 0000, Z = 7700

Return the RUN switch to the normal (center) position.

- f. Enter, manually "7000" in the P-REGISTER. Enter manually the last address to be dumped on the magnetic tape into the A-REGISTER.

NOTE: The first word to be dumped is memory location zero. Put the RUN switch into the up position. The computer will come to a halt with the following information in the REGISTER:

P = 7266, A = FILE-NUMBER, Z = 0000

Return the RUN switch to the normal (center) position.

The A-REGISTER will then contain the file number for the file just dumped on the "Automatic Load and Dump Tape".

G. ERROR STOPS

Return the RUN switch to the normal (center) position.

1. P = 7014, A = 0077 ~ 0000, Z = 7700

REASON: If the A-REGISTER equals "0077", the program to be added is too large (exceeds 7000) for dumping. If the A-REGISTER equals "0000", the last memory address location for dumping was not entered.

RECOVERY: A-REGISTER equals (0077). NONE

A-REGISTER equals (0000). Enter, manually the last memory address location for dumping. Put the RUN switch into the up position.

2. P = 7055, A = 0002, Z = 7700

P = 7203, A = 0002, Z = 7700

P = 7226, A = 0002, Z = 7700

REASON: Tape unit 3 is not ready.

RECOVERY: Correct the conditions of tape unit 3, put the RUN switch into the up position.

3. P = 7102, A = 0020, Z = 7700

REASON: The "Automatic Load and Dump Tape" already has 17 octal files recorded.

RECOVERY: Restart with step 4a (above) and use a different Automatic Load and Dump Tape in step 4a (above).

4. P = 7037, A = 0000, Z = 7700

REASON: Parity error detected on five successive attempts to write.

RECOVERY: Restart with step 4a (above) and use a different "Automatic Load and Dump Tape" in step 4a (above).

H. If the computer stops and none of the error stops described above appear, restart beginning at step 4a (above).

OPERATIONAL SPECIFICATION
MAGNETIC AUTOMATIC LOAD AND DUMP TAPE
FOR THE
8092B TELEPROGRAMMER

INDEX

1. Hardware Required
2. Restrictions
3. Generating a new Magnetic Automatic Load and Dump Tape "BOOT STRAP ONLY"
4. Loading a program or file from the Magnetic Load and Dump Tape to the 8092B Core
5. Dumping a program or file from the 8092B Core to the Magnetic Automatic Load and Dump Tape.

1. Hardware Required

- a. One 8092B Teleprogrammer
- b. 601 Magnetic Tape Drive with a 8193 synchronizer or,
603 Magnetic Tape Drive with a 8093B synchronizer

2. Restrictions

- a. When a program or file is to be transferred from the Magnetic Automatic Load and Dump Tape, and 8092B core, the following will always be true:
 - 1. They start with word zero of bank zero
 - 2. The transferring is done by banks
 - 3. The banks are in consecutive order
 - 4. The maximum bank is bank 14
- b. The Magnetic Automatic Load and Dump Tape shall not exceed 15 (17 octal) files
- c. When a specific program or file is to be updated, the file size must not be altered

3. Generating a new "Magnetic Automatic Load and Dump Tape" (BOOTSTRAP ONLY).

a. Mount the "Magnetic Automatic Load and Dump Tape" on tape drive 3. Set tape drive 3 to a ready state with the magnetic tape at load point.

b. Master Clear 8092B computer

Put the LOAD switch into the up position, then the RUN switch into the up position. One record will be read from the magnetic tape on tape drive 3. The computer will come to a halt with the following information in the registers

P = 1401 OR 1403, A = 377, Z = 0.

Return the LOAD and RUN switches to the normal (center) position.

c. MASTER CLEAR 8092B Computer

Put the RUN switch into the up position. Computer will come to a halt with the following information in the registers.

P = 6716, A = 0, Z = 077.

Return the RUN switch to the normal (center) position.

d. Enter, manually "360" in the A-REGISTER.

Put the RUN switch into the up position. Computer will come to a halt with the following information in the registers

P = 6561, A = 377, Z = 077

Return the RUN switch to the normal (center) position.

e. Mount the magnetic tape that is to be the new "Magnetic Automatic Load and Dump Tape" on tape drive 3.

Put the RUN switch into the up position. Computer will come to a halt with the following information in the registers.

P = 6605, A = 0, Z = 077

Return the RUN switch to the normal (center) position.

f. The magnetic tape on tape drive 3 is now a "Magnetic Automatic Load and Dump Tape". The only file on the tape is the BOOT STRAP, which is a self storing program.

g. ERROR STOPS

Return the RUN switch to normal (center) position.

1. P = 6421, A = 002, Z = 077

Tape drive 3 is not in ready state. Correct the condition and put the RUN switch into the up position.

2. P = 6510, A = 000, Z = 077

Parity error detected on five successive attempts to read or write

a. If error occurs on read, the automatic load and dump tape may be bad. In this case a different load and dump tape must be used in setp 3a (above).

b. If error occurs on write, restart from Step 3a, and use a different tape in Steps 3c (above).

h. If the computer stops and none of the error stops described above appear, restart beginning at step 3a, above.

4. LOADING A PROGRAM OR FILE FROM THE "MAGNETIC AUTOMATIC LOAD AND DUMP TAPE" INTO THE 8092B CORE.

- a. Mount the "Magnetic Automatic Load and Dump Tape" on tape drive 3. Set tape drive 3 to a ready state with the magnetic tape at load point.

Master Clear 8092B computer

Put the LOAD switch into the up position, then the RUN switch into the up position. One record will be read from the magnetic tape on tape drive 3. The computer will come to a halt with the following information in the registers

P = 1401 OR 1403, A = 577, Z = 000.

Return both the LOAD and RUN switches to the normal (center) position.

- b. MASTER CLEAR 8092B COMPUTER

Put the RUN switch into the up position. The computer will come to a halt with the following information in the registers.

P = 6716, A = 0, Z = 077

Return the RUN switch to the normal (center) position.

- c. Enter into the "A-REGISTER" the file number that is to be loaded in the lower 4-bits of the A-REGISTER.

NOTE:

A-REGISTER

Bits 3 2 1 0

F I L E

not used
for load-
ing a file

File Number

If files 1 to 7 are to be called, enter the A-REGISTER with that specific file number. If files 8 to 15 are to be called, enter the A-REGISTER with that specific file number in OCTAL.

Put the RUN switch into the up position. When the computer halts, the file which was specific is now stored into the 8092B core. The registers are as follows:

P = 7361, A = ZERO
NON-ZERO, Z = 077.

If the A-REGISTER is other than zero, the file specified was not loaded correctly. Restart with step 4a.

If the A-REGISTER equal to zero, the file specified was loaded correctly.

d. ERROR STOPS

Return the RUN switch to the normal (center) position.

1. P = 7003, A = 000, Z = 077.

REASON: No assignment job was specified.

RECOVERY: Enter the job assignment into the A-REGISTER.

Put the RUN switch into the up position.

2. P = 7102, A = 002, Z = 077.

REASON: Tape drive unit 3 was not ready.

RECOVERY: Correct the condition of the tape drive

Put the RUN switch into the up position.

3. P = 7203, A = 000, Z = 077

REASON: File requested from the (ALD) does not exist.

RECOVERY: None

4. P = 7275, A = 022, Z = 077

REASON: Parity error detected on five successive attempts to read or write

RECOVERY: None. Restart from step 4a (above) and use a different (ALD) tape

5. P = 7372, A = 377, Z = 077

REASON: The program or file which was to be dumped on the ALD tape exceeds bank 14.

RECOVERY: None (program is too large for dumping)

6. P = 7656, A = 000, Z = 077

REASON: File requested from the ALD does not exist

RECOVERY: None

If the computer stops and none of the error stops described above appear, restart beginning at step 4a (above).

5. DUMPING A PROGRAM OR FILE FROM THE MAGNETIC AUTOMATIC LOAD AND DUMP TAPE (ALD)

- a. The routines that execute the 8092B core dump are stored in banks 14 and 15 (octal 16 and 17). If a program is to be dumped after execution, it cannot use banks 14 or 15 since to do so, would destroy the dump routine.
- b. When a specific file on the ALD is to be altered and the revised file does not alter the previous file size it may return to the ALD under the same file number. If the revision does alter the previous file size, it must be dumped as a new file on the ALD.

INSTRUCTIONS FOR DUMPING TO THE ALD

- c. Mount the ALD tape (on which the file is to be recorded) on tape drive 3. Set the tape drive to a ready state with the ALD at load point.

MASTER CLEAR THE 8092B Computer

SET TAG2 to bank 14 (16 octal)
SET TAG3 to bank 15 (17 octal)
SET THE P-REGISTER TO 7001.

- d. Enter in the A-REGISTER the total number of banks to be dumped. If the dump is to be an updating of the ALD as the same file, then enter the file number also in the A-REGISTER. If the file is to be added to the ALD leave the A-REGISTER file indicator bits blank.

A-REGISTER

Bit Positions 7 6 5 4 3 2 1 0 of the A-REGISTER
Bit Positions 3 2 1 0 3 2 1 0 of the indicators.

BANK FILE

Bank File
Indicator Indicator

Put the RUN switch into the up position. The computer will come to a halt

with the following information in the registers.

P = 7352, A = FILE NUMBER, Z = 77.

Return the RUN switch to the normal (center) position.

e. The A-REGISTER will then contain the file number (for the file just dumped) on the ALD.

f. ERROR STOPS

Return the RUN switch to the normal (center) position.

1. P = 7003, A = 0, Z = 77

REASON: No assignment job was specified

RECOVERY: Enter the job assignment into the A-REGISTER.

Put the RUN switch into the up position

2. P = 7102, A = 2, Z = 77

REASON: Tape drive unit 3 was not ready

RECOVERY: Correct the condition of the tape drive.

Put the RUN switch into the up position.

3. P = 7203, A = 0, Z = 77

REASON: File requested from the ALD does not exist

RECOVERY: None

4. P = 7275, A = 22, Z = 77

REASON: Parity error detected on five successive attempts to read or write

RECOVERY: None. Restart from step 5c above and use a different ALD tape

5. P = 7372, A = 377, Z = 77

REASON: The program or file which was to be dumped on the ALD tape exceeds bank 14.

RECOVERY: None. (Program is too large for dumping.)

6. P = 7656, A = 0, Z = 77

REASON: File requested from the ALD does not exist

RECOVERY: None

g. If the computer stops and none of the error stops described above appear, restart beginning at step 5c, above.

NEW

I. Function

A. General

Program NEW is executed by the 8090 or the 160A Computer. After a program is assembled by OSAS-A for usage with the 8092B computer (Teleprogrammer). It maybe added onto the magnetic "Automatic Load and Dump Tape" and recorded as a specific file for further use with the 8092B Computer.

B. Detail

The binary output paper tape from the OSAS-A assembly of a program, can be loaded with the binary loader into the 8090 or the 160A computer. Program NEW will take each output word and save the lower 8-bits of that word, it will checksum that word and divide it into two 4-bit words. Each 4-bit word is placed in the low order of the output word. NEW identifies the high order 4-bits of the 8-bit word by adding bit position four. It searches the magnetic "Automatic Load and Dump Tape" for the last file, and it then will output the 4-bit words onto the magnetic "Automatic Load and Dump Tape" in record lengths of 102 characters. The last record to be in this file will carry the checksum of the 8-bit words in the last two frames. It will display a number in the A-REGISTER indicating the location of file on the magnetic "Automatic Load and Dump Tape".

II. CONTROL WORDS

NEWA	The last word address of the 8-bit words to be outputted.
NEWB	Checksum of each 8-bit word before storing for output.
NEWC	Programs file number on the (ALD) that was just outputted.
NEWD	Storage of the 8-bit word while being processed.
NEWG	Switch test to indicate the last record for the file being outputted.
NEWH	Last word address of the record for writing on magnetic tape.
NEWF	The start address for the 102 characters to be outputted.

III. ENTRY POINT

NEW

IV. EXIT

NONE

PROGRAM NAME NEW

OUTPUTS NEW FILE ON (ALD)
FROM 8090 OR 160A
COMPUTER TO A 603 TAPE
DRIVE.

PROGRAMS CONTROL WORDS

- NEWA — LAST WORD ADDRESS FOR DUMPING
- NEWB — CHECKSUM OF EACH 8-BIT WORD BEFORE STORING
- NEWC — PROGRAMS FILE NUMBER ON THE (ALD) TAPE
- NEWD — PROCESSING OF THE 8-BIT WORD.
- NEWG — SWITCH FOR LAST RECORD TO BE DUMPED
- NEWH — LAST WORD ADDRESS FOR THE SIZE OF THE RECORD
- NEWF — OUTPUT AREA 102 CHARACTER.

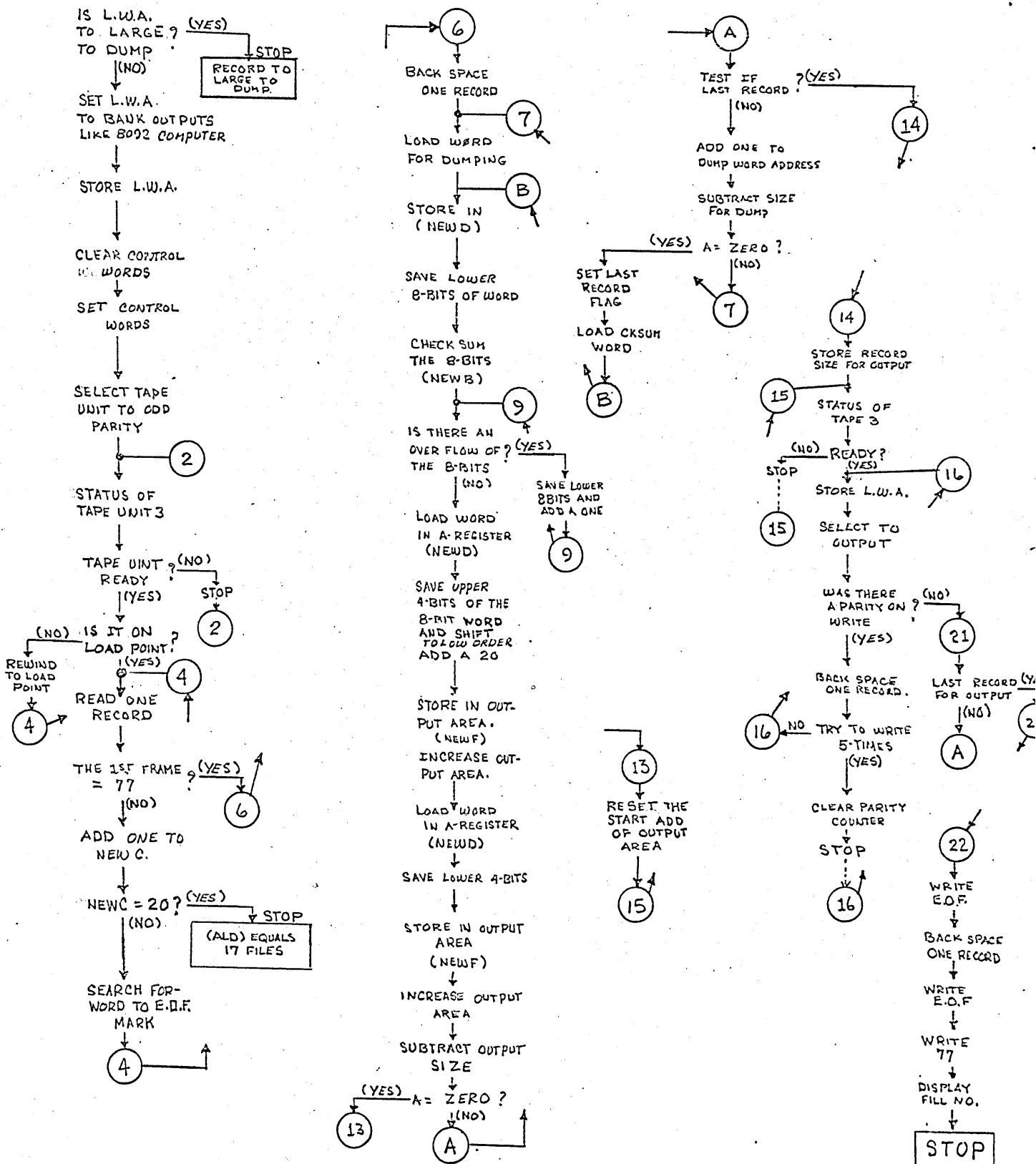

M Nicholas

7000 ORG 7000

```

*****
****
*   PROGRAM NAME *NEW*
*
*   ADD A NEW PROGRAM ON
*   THE MAGNETIC AUTO-
*   MATIC LOAD AND DUMP
*   TAPE
*
****
*****

```

```

7000 7000
0000 PRG 7000
7000 4257 NEW STF NEWA
7001 6012 ZJF NEWI -2
7002 6213 PJF NEWI
7003 1200 LPC 7400
7004 7400
7005 0111 LS6
7006 4203 STF 3
7007 0470 LDN 70
7010 3600 3600
7011 0000 0
7012 6203 PJF NEWI
7013 0477 LDN 77
7014 7700 HLT
7015 0400 NEWI LDN 0
7016 4265 STF NEWB
7017 4267 STF NEWG
7020 4264 STF NEWC
7021 4273 STF NEW7 1
7022 2200 LDC NEWF
7023 7270
7024 4100 STM NEW11 1
7025 7141
7026 3200 ADC 102
7027 0102
7030 4257 STF NEWH
7031 2226 LDF NEWA
7032 1200 LPC 377
7033 0377
7034 6007 ZJF NEW2
7035 2222 LDF NEWA
7036 3200 ADC 400
7037 0400
7040 1200 LPC 7400
7041 7400
7042 4215 STF NEWA

```

```

** PROGRAM IS TOO LARGE TO DUMP.
** CLEAR CONTROL WORDS.

```

7043	7500	NEW2	EXC		1171	** SELECT TAPE DRIVE TO ODD PARITY
7044	1171					
7045	7500		EXC		1143	
7046	1143					
7047	7600		INA			
7050	6010		ZJF	NEW3		
7051	0242		LPN		42	
7052	0740		SBN		40	
7053	6013		ZJF	NEW4	4	
7054	0402		LDN		2	
7055	7700		HLT			** TAPE DRIVE 3 IS NOT READY
7056	6513		NZB	NEW2		
7057	0000	NEWA				** LAST WORD ADDRESS FOR DUMP.
7060	7500	NEW3	EXC		1163	** REWIND TO LOAD POINT
7061	1163					
7062	7500	NEW4	EXC		1143	** READ 1ST FRAME ON THE RECORD
7063	1143					
7064	7600		INA			
7065	6503		NZB	NEW4		
7066	7500		EXC		1133	
7067	1133					
7070	7600		INA			
7071	0777		SBN		77	
7072	6016		ZJF	NEW6		
7073	5611		ADF	NEWC		
7074	0720		SBN		20	
7075	6004		ZJF	NEWS		
7076	7500		EXC		1133	
7077	1133					
7100	6516		NZB	NEW4		
7101	0420	NEWS	LDN		20	** SET A-REGISTER TO INDICATE
7102	7700		HLT			(ALD) ALL READY = 17 FILES
7103	0000	NEWB				** CKSUM OF EACH WORD BEFORE DUMPED
7104	0000	NEWC				** PROGRAMS FILE NO. ON THE (ALD)
7105	0000	NEWD				** PROGRAMS WORDS FOR DUMPING
7106	0000	NEWG				** SWITCH FOR LAST RECORD TO DUMP
7107	7372	NEWH		NEWF	102	** LAST WORD ADDRESS FOR THE RECORDS
7110	7500	NEW6	EXC		1123	** BACK SPACE ONE RECORD BEFORE DUMP
7111	1123					
7112	7600		INA			
7113	2100	NEW7			2100	** LOAD WORD FOR DUMPING
7114	0000				0	
7115	4310		STB	NEWD		
7116	1200	NEW8	LPC		377	** CKSUM THE LOWER 8-BITS.
7117	0377					
7120	5315		RAB	NEWB		
7121	1200	NEW9	LPC		400	** ECHECK OVERFLOW OF THE 8-BITS
7122	0400					

7123	6007		ZJF	NEW10		
7124	2321		LDB	NEWB		
7125	1200		LPC		377	
7126	0377					
7127	4324		STB	NEWB		
7130	5725		AOB	NEWB		
7131	6510		NZB	NEW9		
7132	2325	NEW10	LDB	NEWD		** LOAD WORD TO BE DIVIDE.
7133	1200		LPC		360	
7134	0360					
7135	0115		RS2			
7136	0115		RS2			
7137	0620		ADN		20	
7140	4100	NEW11	STM	NEWF		** STORE HIGH ORDER OF THE 8-BIT WOR
7141	7270					
7142	5701		AOB	NEW11	1	
7143	4204		STF	NEW12		
7144	2337		LDB	NEWD		
7145	0217		LPN		17	
7146	4100			4100		
7147	0000	NEW12				** ADDRESS TO STORE LOWER 4-BITS
7150	5707		AOB	NEW11	1	
7151	4302		STB	NEW12		
7152	3600		SBC	NEWF	102	
7153	7372					
7154	6013		ZJF	NEW13		
7155	2347		LDB	NEWG		
7156	6115		NZF	NEW14		
7157	5743		AOB	NEW7	1	
7160	3500		SBM	NEWA		
7161	7057					
7162	6547		NZB	NEW7		
7163	5755		AOB	NEWG		
7164	2361		LDB	NEWB		
7165	7101		JFI		1	
7166	7115			NEW7	2	
7167	2200	NEW13	LDC	NEWF		** RESET THE STORING ADDRESS TO A
7170	7270					
7171	4330		STB	NEW11	1	BEGIANNING STATE
7172	6103		NZF	NEW15		
7173	2332	NEW14	LDB	NEW11	1	** STORE THE L.W.A. OF THE RECORD
7174	4365		STB	NEWH		
7175	7500	NEW15	EXC		1143	** STATUS OF THE TAPE DRIVE 3
7176	1143					
7177	7600		INA			
7200	6005		ZJF	NEW16		
7201	0202		LPN		2	
7202	6505		NZB	NEW15		

7203	7700		HLT			** TAPE DRIVE 3 IS NOT READY
7204	6507		NZB	NEW15		
7205	2100	NEW16	LDM	NEWH		** STORE THE L.W.A. OF RECORD
7206	7107					
7207	4204		STF	NEW17		FOR THE OUTPUT.
7210	7500		EXC		1113	
7211	1113					
7212	7304		OUT	NEW18		
7213	0000	NEW17				** PRESTORED L.W.A.
7214	7101		JFI		1	
7215	7217			NEW19		
7216	7270	NEW18		NEWF		** FIRST WORD ADDRESS FOR OUTPUT.
7217	7500	NEW19	EXC		1143	** STATUS OF THE LAST RECORD
7220	1143					
7221	7600		INA			THAT HAS BEEN OUTPUTTED.
7222	6020		ZJF	NEW21		
7223	0206		LPN		6	
7224	0704		SBN		4	
7225	6003		ZJF	NEW20		
7226	7700		HLT			** TAPE DRIVE 3 IS NOT READY
7227	6510		NZB	NEW19		
7230	7500	NEW20	EXC		1123	** PARITY ERROR, BACKSPACE
7231	1123					
7232	7600		INA			ONE RECORD TO TRY AGAIN
7233	5606		AOF	NEW1		
7234	0705		SBN		5	
7235	6530		NZB	NEW16		
7236	4203		STF	NEW1		
7237	7700		HLT			
7240	6433		ZJB	NEW16		
7241	0000	NEW1				** PARITY ERROR COUNTER.
7242	4301	NEW21	STB	NEW1		** TEST POINT FOR LAST RECORD
7243	2100		LDM	NEW1		
7244	7106					
7245	6103		NZF	NEW22		TO BE OUTPUTTED.
7246	7101		JFI		1	
7247	7155			NEW12	6	
7250	7500	NEW22	EXC		1113	** OUTPUT IDENTIFICATION MARKS
7251	1113					
7252	7500		EXC		1123	ON THE (ALD) TAPE.
7253	1123					
7254	7600		INA			
7255	7500		EXC		1113	
7256	1113					
7257	7500		EXC		1113	
7260	1113					
7261	7477		OTN		77	
7262	7500		EXC	1163		

7263	1163			
7264	2100	LDM	NEWC	
7265	7104			
7266	7700	HLT		
	7270	PRG		7270
7270	0000	NEWF		
	0000	END		

** FILE NO. INDICATED IN A-REGISTER

PROGRAM PACK

FORMAT

MEMORY OF THE
8090 OR 160A COMPUTER

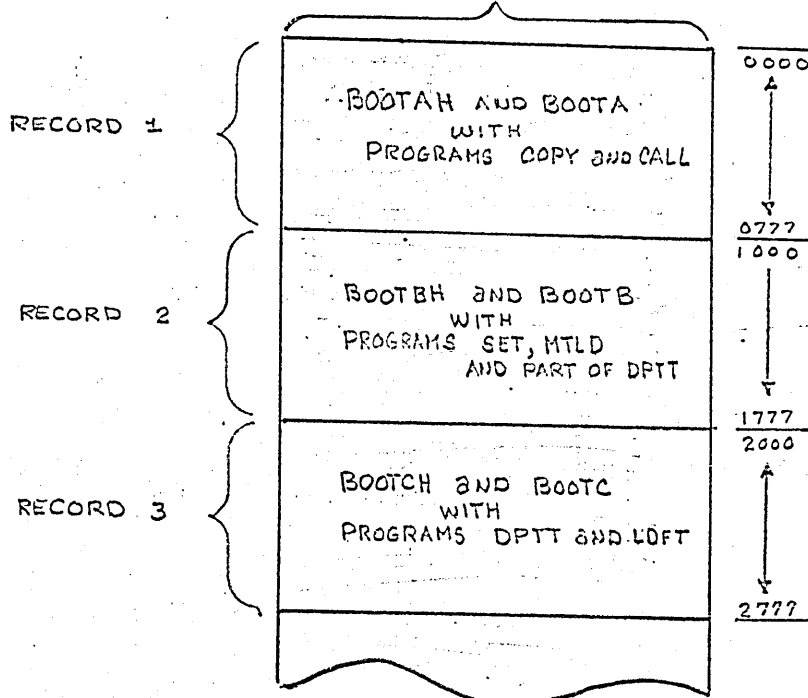

RECORDS OF THE OUTPUT STORED ON MAGNETIC TAPE.

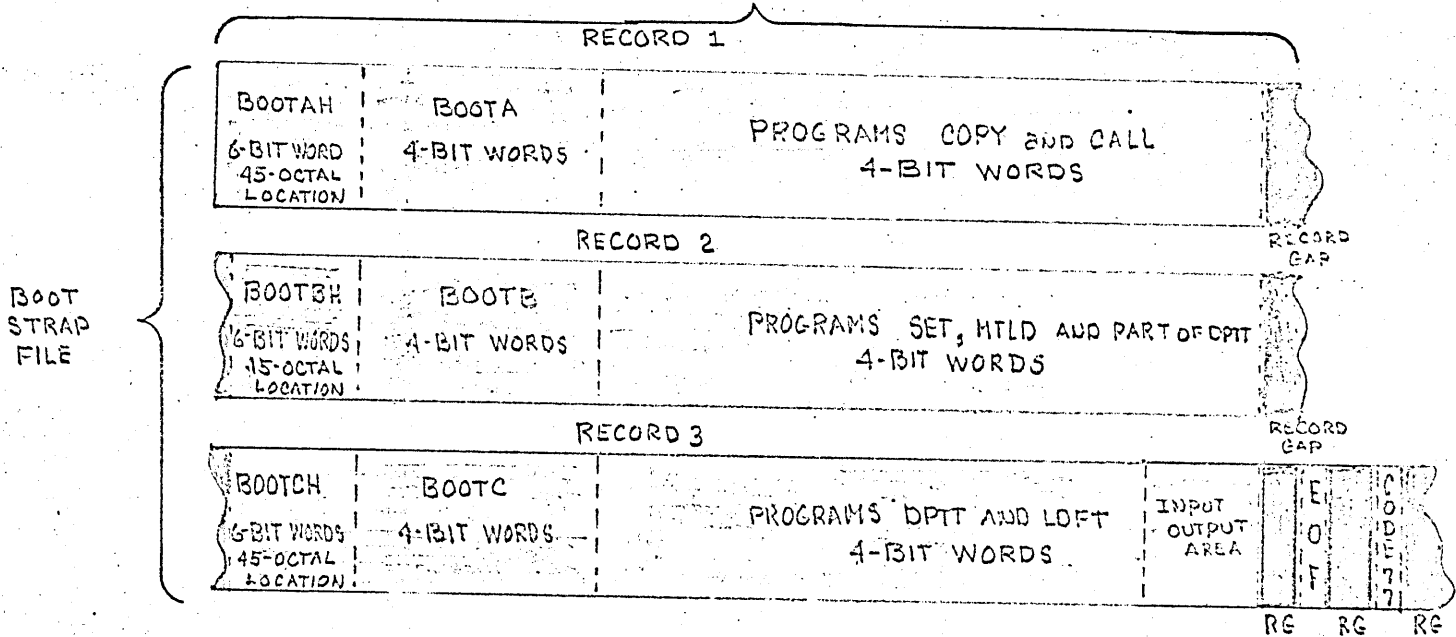

IT TAKES THE MEMORY LOCATIONS FROM 0000 TO 2777 OF THE 8090 OR 160A COMPUTER AND OUTPUTS THEM TO THE MAGNETIC TAPE. STARTS WITH RECORD 1, THEN RECORD 2 AND 3 FOLLOWS.

n nicholas

PACK

I. Function

A. General

This program is for the 8090 or 160A Computer and will generate the BOOT STRAP on the Automatic Load and Dump Tape which can be used by the 8092B Computer.

B. Detail

The binary output paper tape from the OSAS-A assembly for the BOOT STRAP is loaded with a binary loader into the 8090 or 160A core starting at word zero.

Records of the BOOT STRAP take the following Core locations. Record one, is in 0000 to 0777, record two is in 1000 to 1777 and record three is in 2000 to 2777. The first 45 octal locations of the records use only the low 6-bits of the 12-bit word, and are stored into an output area. The remaining locations use the lower 8-bits of the 12-bit word, and are divided into two 4-bit words with the high order of the 8-bit word being identified, then are stored into an output area.

Record one is processed in this manner first, then is outputted to the magnetic tape in the binary and low density mode, record two and three follow. The end of file mark is then outputted and followed with a code mark. (Octal 77). The magnetic tape is now an Automatic Load and Dump Tape for the 8092B Computer.

II. Control Words

PACKA	Starting address of the record being dumped.
PACKB	Last word address, for the 6-bit words first, then the 4-bit words.
PACKC	Starting address of the output area.
PACKD	Temporary storage for the 12-bit words.
PACKE	Counter for the output of the three records.

III. Entry Points

None

IV. Exits

None

PROGRAM NAME PACK

OUTPUTS BOOT, TO MAGNETIC TAPE
FROM 8090 TO A 603

PROGRAM CONTROL WORDS

PACKA START ADDRESS OF PROGRAM BEING DUMPED
 PACKB STOP ADDRESS 1ST 6BITS THE 4BIT PREWORD
 PACKC START ADDRESS OF OUTPUT AREA
 PACKD TEMPORARY STORING OF CHARACTER
 PACKE COUNTER FOR 3 RECORDS FOR OUTPUT.

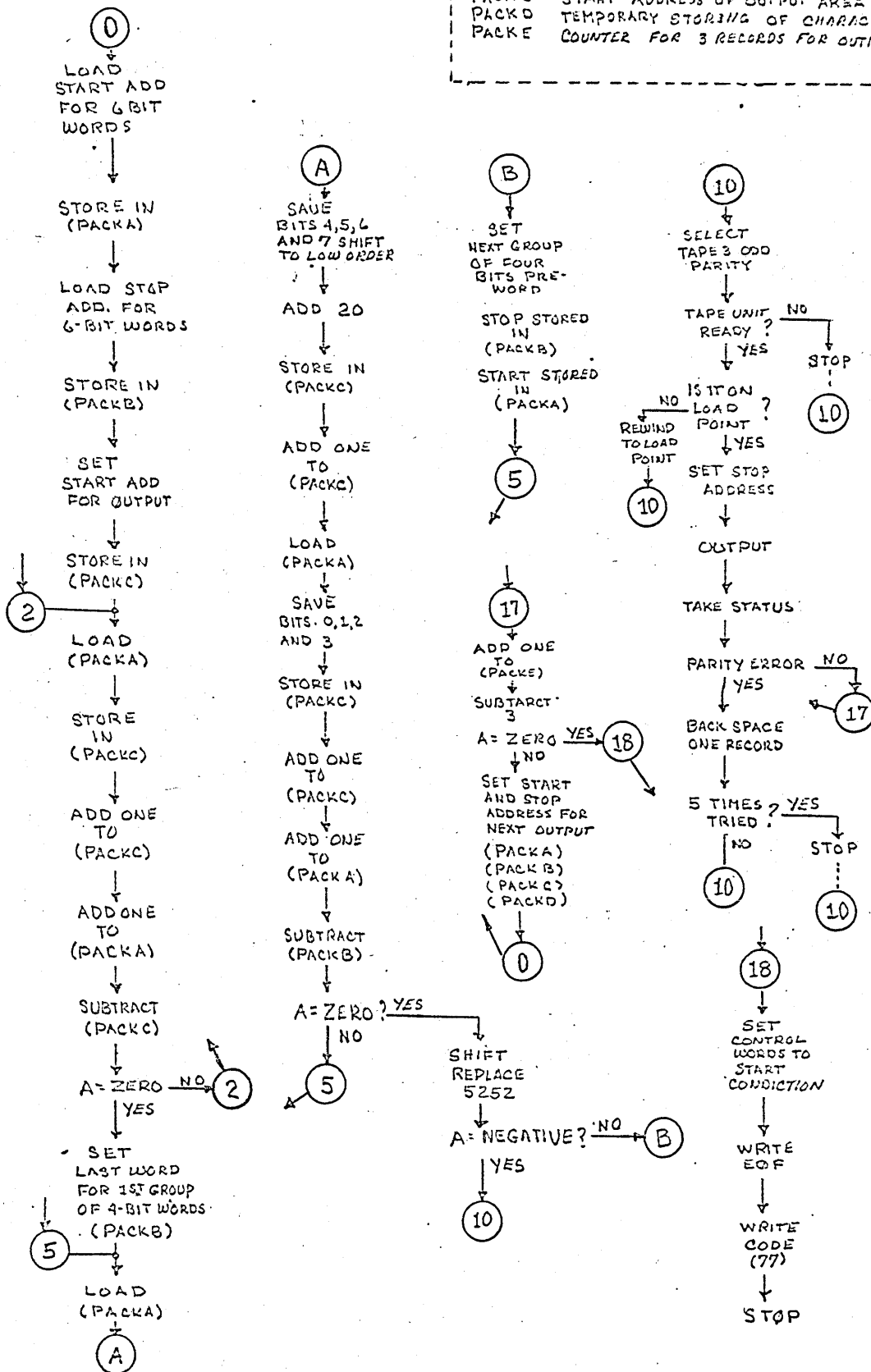

7000	ORG	7000	
			***** * 8090 PROGRAM TO CREATE BOOT * STRAP ON TAPE FOR 8092 * TELEPROGRMMER *****
	0000		
7000	2200	PACK	BNKO LDC 0
7001	0000		
7002	4273		STF PACKA
7003	2200	PACK1	LDC 56
7004	0056		
7005	4271		STF PACKB
7006	2200		LDC 3000
7007	3000		
7010	4267		STF PACKC
7011	4100		STM PACK14
7012	7141		
7013	2262	PACK2	LDF PACKA ** START ADDRESS OF DATA
7014	4204		STF PACK3
7015	2262		LDF PACKC
7016	4204		STF PACK4
7017	2100		2100
7020	0000	PACK3	** PRESTORED ADDRESS FOR LOADING
7021	4100		4100
7022	0000	PACK4	** PRESTORED ADDRESS FOR STORING
7023	5654		AOF PACKC
7024	5651		AOF PACKA
7025	3651		SBF PACKB
7026	6513		NZB PACK2
7027	2200		LDC 227
7030	0227		
7031	4245		STF PACKB
7032	2243	PACK5	LDF PACKA ** GET NEXT ADDRESS FOR NEXT WORD
7033	4204		STF PACK6
7034	2243		LDF PACKC
7035	4212		STF PACK7
7036	2100		2100
7037	0000	PACK6	** PRESTORED ADDRESS FOR LOADING
7040	4240		STF PACKD
7041	1200		LPC 360
7042	0360		
7043	0115		RS2
7044	0115		RS2
7045	0620		ADN 20
7046	4100		4100
7047	0000	PACK7	** PRESTORED ADDRESS FOR STORING
7050	5627		AOF PACKC

7051	4204		STF	PACK8		
7052	2226		LDF	PACKD		
7053	0217		LPN		17	
7054	4100				4100	
7055	0000	PACK8				** PRESTORED ADDRESS FOR STORING
7056	5621		AOF	PACKC		
7057	5616		AOF	PACKA		
7060	3616		SBF	PACKB		
7061	6527		NZB	PACK5		
7062	4600		SRC		5252	
7063	5252					
7064	6316		NJF	PACK10		
7065	2200		LDC		400	
7066	0400					
7067	4206		STF	PACKA		
7070	2200	PACK9	LDC		1001	** SET NEW ADDRESS FOR STOP.
7071	1001					
7072	4204		STF	PACKB		
7073	7101		JFI		1	
7074	7032			PACK5		
7075	0000	PACKA				** START ADDRESS FOR LOADING CHAR.
7076	0000	PACKB				** STOP ADDRESS FOR 6 BITS, THEN 4 B
7077	0000	PACKC				** START OF OUTPUT AREA
7100	0000	PACKD				** TEMPORARY STORAGE OF CHARACTER
7101	0000	PACKE				** TIMES COUNTER FOR 3 OUTPUTS
7102	4600	PACK10	SRC		2222	** CHECK IF FIRST TIME THROUGH
7103	2222					
7104	6224		PJF	PACK12		
7105	7500		EXC		1171	
7106	1171					
7107	7500		EXC		1143	
7110	1143					
7111	7600		INA			
7112	0242		LPN		42	
7113	4206		STF	PACK11		
7114	0202		LPN		2	
7115	6003		ZJF	PACK11	-1	
7116	7700		HLT			
7117	6510		NZB	PACK10	5	
7120	2200				2200	
7121	0000	PACK11				** PRESTORED STATUS
7122	0240		LPN		40	
7123	6105		NZF	PACK12		
7124	7500		EXC		1163	
7125	1163					
7126	7101		JFI		1	
7127	7107			PACK10	5	
7130	2331	PACK12	LDB	PACKC		** LAST WORD ADDRESS FOR OUTPUT

7131	0601		ADN		1	
7132	4204		STF	PACK13		
7133	7500		EXC		1113	
7134	1113					
7135	7304		OUT	PACK14		
7136	0000	PACK13				** PRESTORED L. W. A. FOR OUTPUT.
7137	7101		JFI		1	
7140	7142			PACK15		
7141	0000	PACK14				** PRESTORED F. W. A. FOR OUTPUT
7142	7500	PACK15	EXC		1143	** STATUS OF LAST OUTPUT
7143	1143					
7144	7600		INA			
7145	0204		LPN		4	
7146	6015		ZJF	PACK17		
7147	7500		EXC		1123	
7150	1123					
7151	7600		INA			
7152	5610		AOF	PACK16		
7153	0705		SBN		5	
7154	6552		NZB	PACK10		
7155	4205		STF	PACK16		
7156	2200		LDC		7777	
7157	7777					
7160	7700		HLT			
7161	6557		NZB	PACK10		
7162	0000	PACK16				** PARITY ERROR COUNTER.
7163	5762	PACK17	AOB	PACKE		** TIMES COUNTER FOR OUTPUT
7164	0703		SBN		3	
7165	6027		ZJF	PACK18		
7166	2200		LDC		1000	
7167	1000					
7170	5100		RAM	PACK	1	
7171	7001					
7172	2200		LDC		1000	
7173	1000					
7174	5100		RAM	PACK1	1	
7175	7004					
7176	2200		LDC		1000	
7177	1000					
7200	5100		RAM	PACK4	6	
7201	7030					
7202	2200		LDC		1000	
7203	1000					
7204	5100		RAM	PACK9	-2	
7205	7066					
7206	2200		LDC		1000	
7207	1000					
7210	5100		RAM	PACK9	1	

7211	7071				
7212	7101		JFI	1	
7213	7000			PACK	
7214	4100	PACK18	STM	PACKE	** CLEAR TIMES COUNTER AND
7215	7101				
7216	4100		STM	PACK	1 RESET TO START CONDICTION
7217	7001				
7220	0456		LDN		56
7221	4100		STM	PACK1	1
7222	7004				
7223	2200		LDC		227
7224	0227				
7225	4100		STM	PACK4	6
7226	7030				
7227	2200		LDC		400
7230	0400				
7231	4100		STM	PACK9	-2
7232	7066				
7233	2200		LDC		1001
7234	1001				
7235	4100		STM	PACK9	1
7236	7071				
7237	7500		EXC		1113
7240	1113				
7241	7500		EXC		1113
7242	1113				
7243	7477		OTN		77
7244	7700		HLT		
7245	7101		JFI		1
7246	7000			PACK	
	0000		END		

BOOHA and BOOTA FORMAT

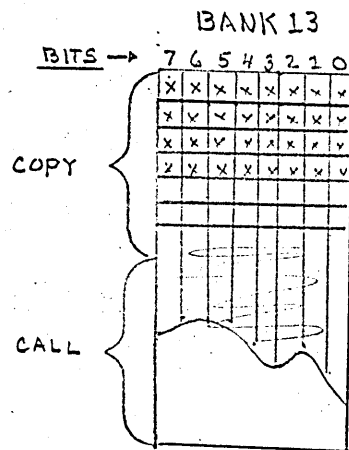
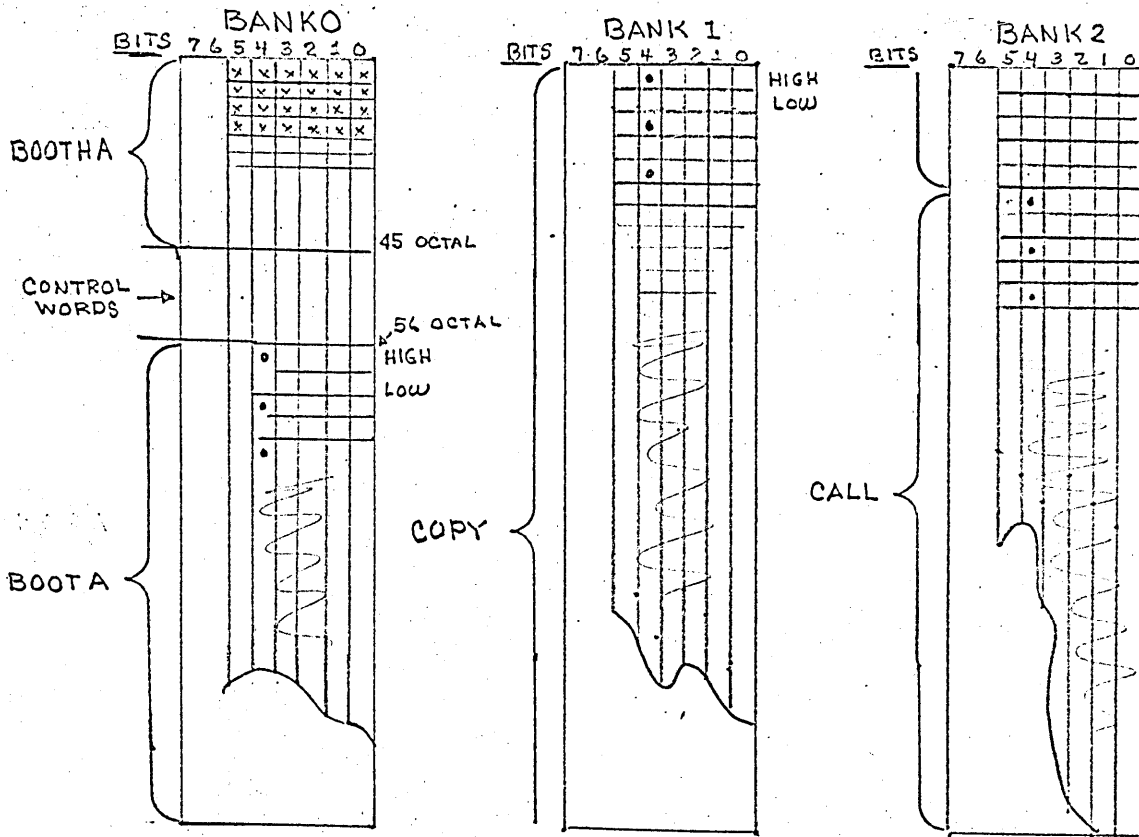

BOOHA : BANK-0, THE FIRST 45 OCTAL LOCATION ARE 6-BIT WORDS.
 BANK-0 FROM 56 (OCTAL) TO 376 (OCTAL) OF BANK 2,
 THEY ARE 4-BIT WORDS WITH THE HIGH ORDER FOR AN 8-BIT
 WORD BEING IDENTIFIED BY BIT POSITION 4.

BANK 13 COPY AND CALL

AFTER, THE 4-BIT WORDS ARE ASSEMBLED INTO 8-BIT WORDS.

n nicholas

BOOTAH AND BOOTA

I. Function

A. General

To store two programs COPY and CALL into Bank 13 and then exit to Program Call for the next record of the BOOT STRAP file.

B. Detail

The BOOT STRAP has three records in its file. Programs BOOTAH and BOOTA, is the first record and are loaded into the 8092B core with the Load and Run switches of the Teleprogrammer starting with word 0, Bank 0. BOOTAH is a set of six bit per word instructions, when executed it builds a set of eight bit per word instructions, from two four bit words. This becomes program BOOTA. BOOTA will take the remaining four bit words, combine the high and the low orders, to build an eight bit word and stores them into bank 13. These eight bit words are program instructions belonging to COPY and CALL.

Then will exit to Program CALL for the next record of the BOOT STRAP.

II. Control Tags

TAG 1. Used while combining the high and the low order of each word before storing.

TAG 2. First set to Bank 13 to be used while storing programs COPY and CALL, then is set for the exit to program CALL.

III. Control Words

BOOTAO Temporary storage for the building of the eight bit word.

BOOTAA Lower order of the eight bit word.

BOOTAB High order of the eight bit word.

BOOTAC Temporary storage for the building of the eight bit word.

BOOTAD Address for storing COPY and CALL.

BOOTAE Crossing of the banks.

BOOTAF Starting address of the four bit words.

BOOTAG Flag test for the completion of storing COPY and CALL to their proper bank.

IV Entry Point

BOOTAH

V. Exits

To Program CALL

PROGRAM NAME

BOOTAH

IT ASSEMBLES A PROGRAM TO WORK WITH TAGS

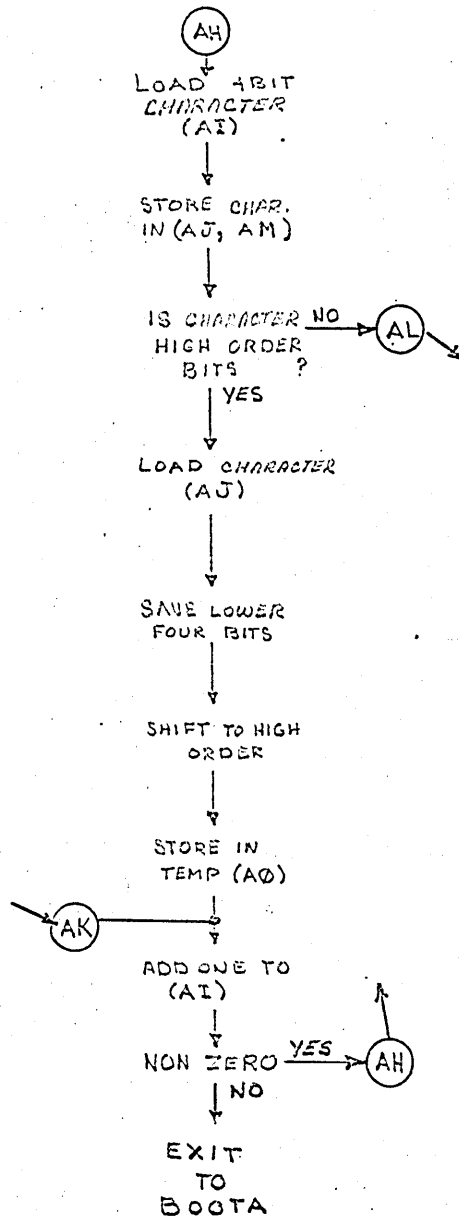

PROGRAM CONTROL WORDS	
BOOTAI	START ADDRESS OF FOUR BITS PER WORD
" " AJ	HIGH ORDER OF WORD
" " AM	LOW ORDER OF WORD
" " AO	TEMPORARY STORAGE
" " AN	START ADDRESS OF 8 BITS PER WORD
" " A	START OF PROGRAM

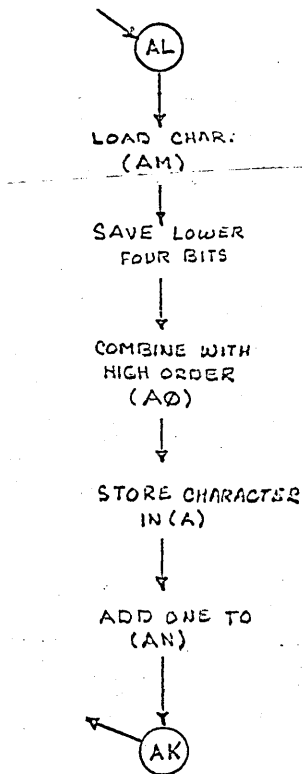

PROGRAM NAME

BOOTA

ASSEMBLES PROGRAMS COPY AND CALL
STORES THEM IN BANK 15

PROGRAM CONTROL WORDS

BOOTAA Low ORDER of 4 BIT WORD
 BOOTAB High ORDER of 4 BIT WORD
 BOOTAC TEMPORARY STORAGE BUILDING WORD
 BOOTAD AREA FOR STORING 8 BIT WORD
 BOOTAE CROSSING 4 BIT WORD BANKS
 BOOTAF LOAD AREA FOR 4 BIT WORDS
 BOOTAG COMPLETION TEST

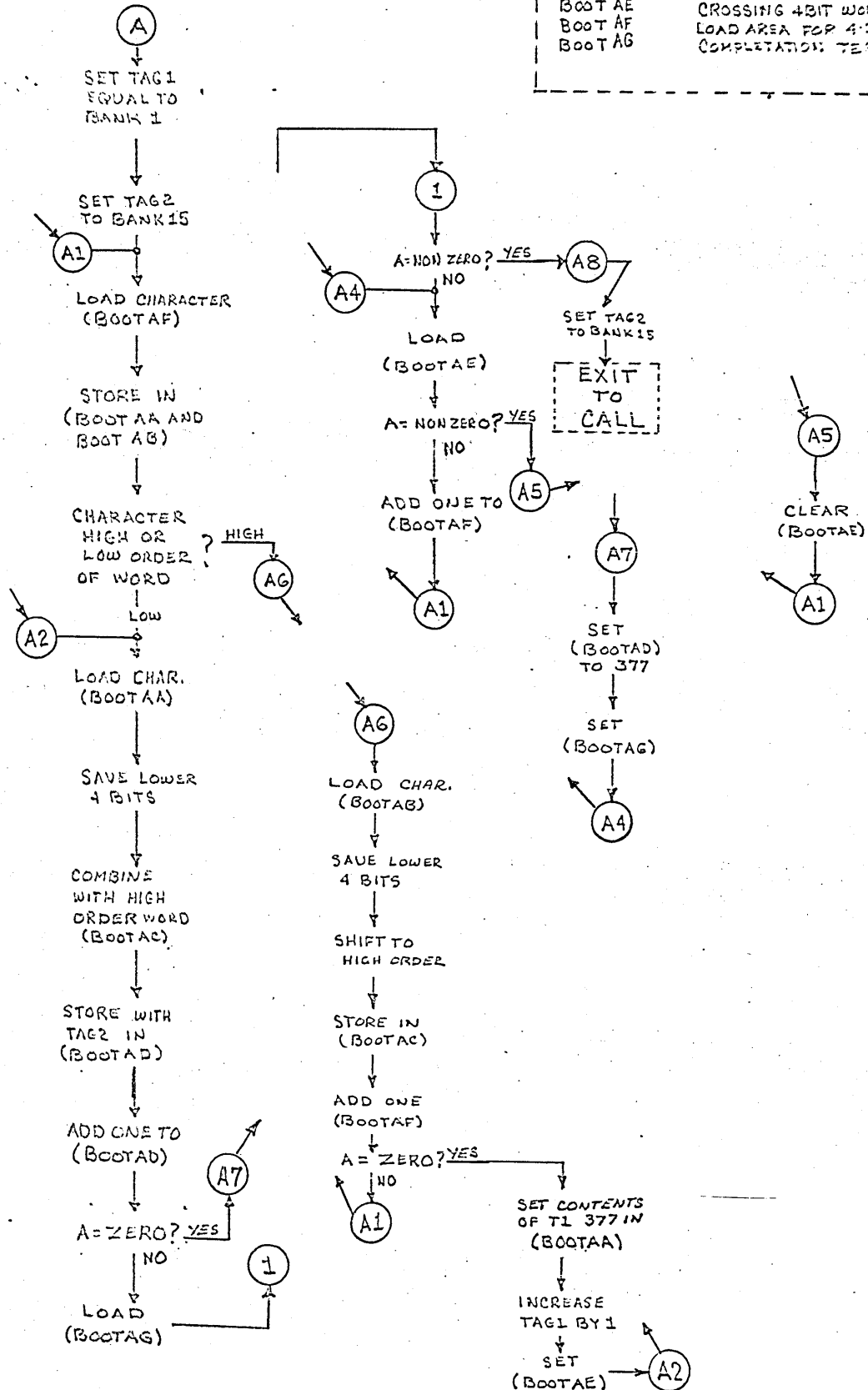

0000 PRG 0

```

*****
***** PROGRAM NAMES *****
*
*      BOOTAH
*
* 6BIT INSTRUCTION PROGRAM
*  ASSEMBLES AND 8BIT
*  INSTRUCTION PROGRAM
*  CALLED BOOTA
*
*      BOOTA
*
* 8BIT INSTRUCTION PROGRAM
*  ASSEMBLES AND 8BIT
*  INSTRUCTION WORD
*  STORES THEM IN HIGH
*****  CORE *****
*****
    
```

0000	0021	BOOTAH	LDM		
0001	0056	BOOTAI		BOOTA	
0002	0041		STM		
0003	0013			BOOTAJ	
0004	0041		STM		
0005	0033			BOOTAM	
0006	0010		LPN		
0007	0020			20	
0010	0060		ZJP		
0011	0032			BOOTAL	
0012	0020		LDN		
0013	0000	BOOTAJ			** LOAD HIGH ORDER OF WORD
0014	0010		LPN		
0015	0017			17	
0016	0001		SHA		
0017	0001		SHA		
0020	0001		SHA		
0021	0001		SHA		
0022	0041		STM		
0023	0046			BOOTAO	
0024	0055	BOOTAK	RAO		** INCREASE START ADDRESS BY ONE
0025	0001			BOOTAI	
0026	0061		NZP		
0027	0000			BOOTAH	
0030	0064		UJP		
0031	0056			BOOTA	
0032	0020	BOOTAL	LDN		** LOAD LOW ORDER OF WORD
0033	0000	BOOTAM			** PRESTORED WORD
0034	0010		LPN		

0035	0017			17	
0036	0015		LSM		
0037	0046			BOOTAO	
0040	0041		STM		
0041	0056	BOOTAN		BOOTA	** STORE WORD INCREASE
0042	0055		RAO		STORE AREA BY ONE
0043	0041			BOOTAN	
0044	0064		UJP		
0045	0024			BOOTAK	
0046	0000	BOOTAO			** STORE AREA, BUILDING WORD
0047	0000	BOOTAA			** LOWER ORDER OF WORD
0050	0000	BOOTAB			** HIGH ORDER OF WORD
0051	0000	BOOTAC			** STORE AREA, FOR BUILDING WORD
0052	0000	BOOTAD			** AREA FOR STORING WORD
0053	0000	BOOTAE			** CROSSING OF BANK
0054	0000	BOOTAF			** START ADDRESS OF INPUT
0055	0000	BOOTAG			** TEST, FOR COMPLETATION
0056	0020	BOOTA	LDN		
0057	0001			1	
0060	0102		ATT	T1	
0061	0020		LDN		
0062	0015			15	
0063	0202		ATT	T2	
0064	0122	BOOTAI	LDI	T1	** ADDRESS OF NEXT CHARACTER
0065	0054			BOOTAF	
0066	0041		STM		
0067	0047			BOOTAA	
0070	0041		STM		
0071	0050			BOOTAB	
0072	0010		LPN		
0073	0020			20	
0074	0061		NZP		
0075	0133			BOOTAG	
0076	0021	BOOTAG	LDM		** LOWER ORDER OF WORD
0077	0047			BOOTAA	
0100	0010		LPN		
0101	0017			17	
0102	0015		LSM		
0103	0051			BOOTAC	
0104	0242	BOOTAG	STI	T2	** STORE BUILT CHARACTER
0105	0052			BOOTAD	
0106	0055		RAO		
0107	0052			BOOTAD	
0110	0060		ZJP		
0111	0165			BOOTAG	
0112	0021		LDM		
0113	0055			BOOTAG	
0114	0061		NZP		

0115	0175			BOOTAB	
0116	0021	BOOTAB	LDM	BOOTAB	** TEST IF CROSSING BANKS
0117	0053			BOOTAC	
0120	0061		NZP	BOOTAC	
0121	0126			BOOTAD	
0122	0055		RAO	BOOTAD	
0123	0054			BOOTAE	
0124	0064		UJP	BOOTAE	
0125	0064			BOOTAF	
0126	0003	BOOTAD	TTA	BOOTAF	
0127	0041		STM	BOOTAI	** CROSSING OF A BANK
0130	0053			BOOTAI	
0131	0064		UJP	BOOTAI	
0132	0064			BOOTAI	
0133	0021	BOOTAD	LDM	BOOTAI	** HIGH ORDER OF CHARACTER
0134	0050			BOOTAB	
0135	0010		LPN		
0136	0017			17	
0137	0001		SHA		
0140	0001		SHA		
0141	0001		SHA		
0142	0001		SHA		
0143	0041		STM		
0144	0051			BOOTAC	
0145	0055		RAO	BOOTAC	
0146	0054			BOOTAF	
0147	0061		NZP	BOOTAF	
0150	0064			BOOTAI	
0151	0121		LDM	TI	
0152	0377			377	
0153	0041		STM		
0154	0047			BOOTAA	
0155	0103		TTA	TI	
0156	0030		ADN		
0157	0001			1	
0160	0102		ATT	TI	
0161	0055		RAO		
0162	0053			BOOTAE	
0163	0064		UJP	BOOTAE	
0164	0076			BOOTAB	
0165	0020	BOOTAD	LDN	BOOTAB	** SET STORE AREA TO 377
0166	0377			377	FOR NEXT CHARACTER
0167	0041		STM		
0170	0052			BOOTAD	
0171	0055		RAO	BOOTAD	
0172	0055			BOOTAG	
0173	0064		UJP	BOOTAG	
0174	0116			BOOTAB	

0175	0020	BOOTAS	LDN	** SET TAG2 FOR JUMP
0176	0015			EXIT TO PROGRAM CALL
0177	0202		ATT	T2
0200	0264		UJP	T2
0201	7777			CALL

BOOTBH and BOOTB FORMAT

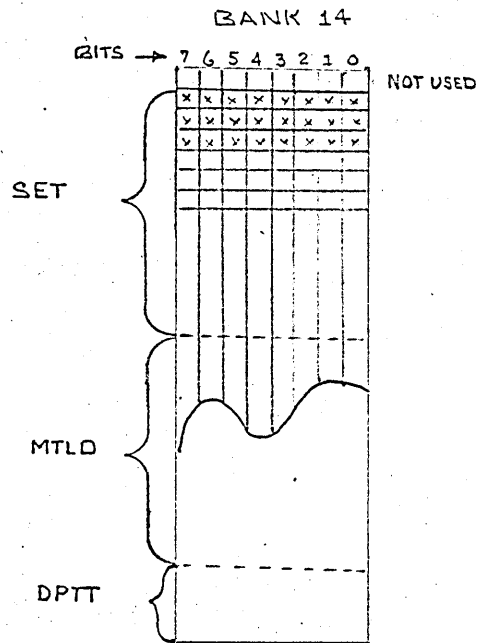
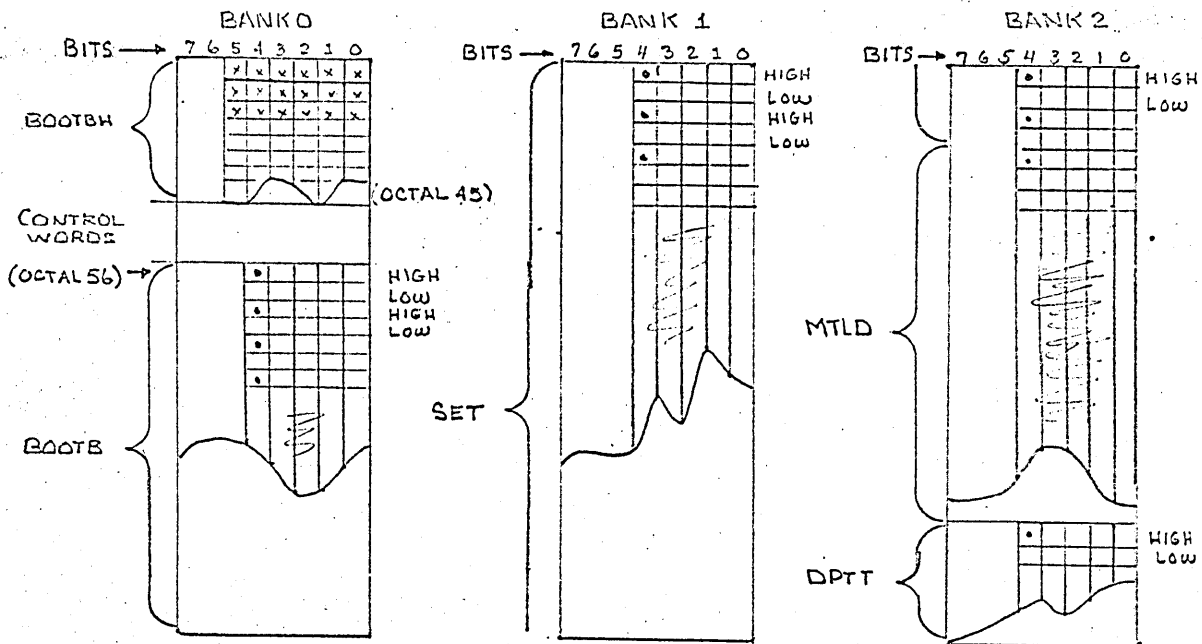

BOOTBH BANK-0, THE FIRST 45 (OCTAL) LOCATION ARE 6-BIT WORDS.
 BANK0 FROM 56 (OCTAL) TO 376 OF BANK 2, THEY ARE
 4-BIT WORDS WITH THE HIGH ORDER FOR AN 8-BIT WORD
 BEING IDENTIFIED BY BIT POSITION 4.

BANK 14 SET MTLT AND DPTT.
 AFTER, THE 4-BIT WORDS ARE ASSEMBLED INTO 8-BIT WORDS.
 NOTE: WORD 000 NOT USED.

BOOTBH AND BOOTB

I. Function

A. General

To store the programs, SET, MTL D and part of the DPTT, into bank 14 and then exit to program CALL for the third record of the boot strap.

B. Detail

The BOOT STRAP has three records in its file. Programs BOOTBH and BOOTB, is the second record and becomes loaded into the 8092B core by program CALL, starting with address zero of bank zero. BOOTBH is a set of six bit per word instructions, when executed, it builds a set of eight bit per word instructions from two four bit words. This becomes program BOOTB. BOOTB will take remaining four bit words, combine the high and the low orders, to build an eight bit word and stores them into bank 14. These eight bit words are program instructions belonging to SET, MTL D and DPTT.

Then will exit to program CALL for record three of the BOOT STRAP.

II. Control Tags

TAG 1. Used while combining the high and the low order of each word before storing.

TAG 2. First set to bank 14 to be used while storing programs SET, MTL D and DPTT, then is set for the exit to program CALL.

III. Control Words

BOOTBO Temporary storage for the building of the eight bit word.

BOOTBA Lower order of the eight bit word.

BOOTBB High order of the eight bit word.

BOOTBC Temporary storage for the building of the eight bit word.

BOOTBD Address for storing SET, MTL D and DPTT.

BOOTBE Crossings of a bank.

BOOTBF Starting address of the four bit words.

BOOTBG Flag Test for completion of storing SET, MTL D and DPTT to their proper bank.

IV. Entry Point

BOOTHB

V. Exits

To program CALL

PROGRAM NAME

BOOTBH

IT ASSEMBLES A PROGRAM TO WORK WITH TAGS

PROGRAM CONTROL WORDS	
BOOTBI	START ADDRESS OF 4-BIT WORDS
BJ	HIGH ORDER OF WORD
BM	LOW ORDER OF WORD
BQ	TEMPORARY STORAGE
BH	START ADDRESS OF 8-BIT WORDS
BOOTB	STARTING ADDRESS OF PROGRAM BOOTB

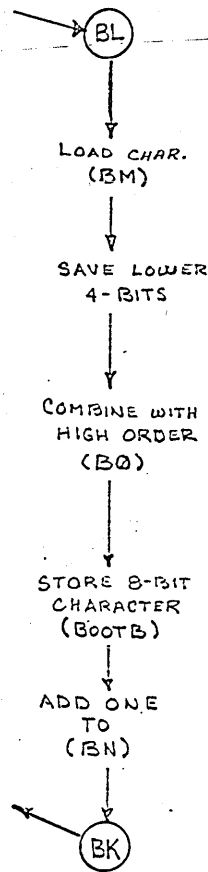
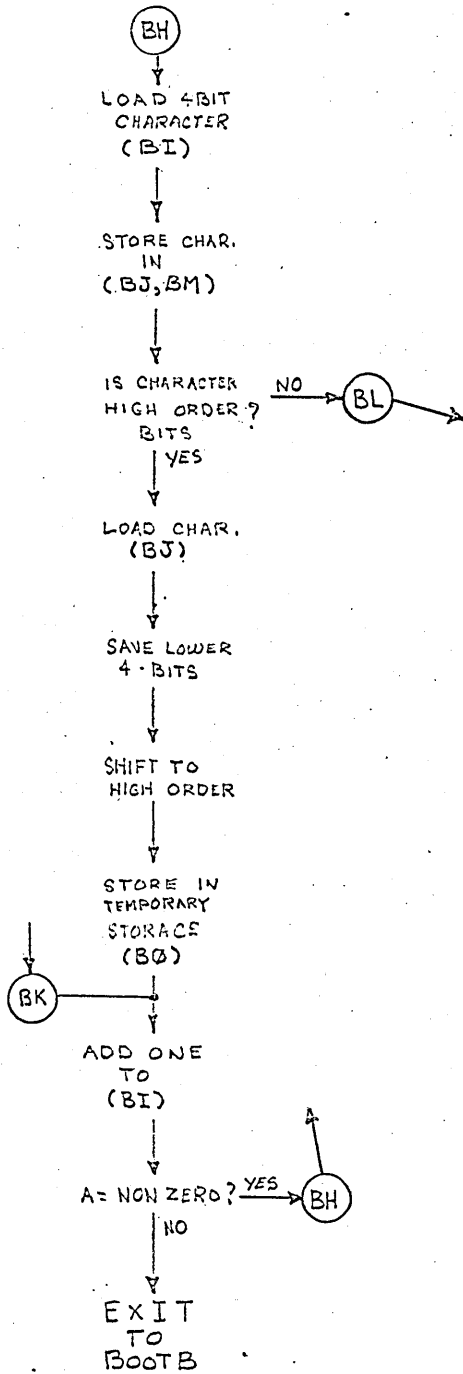

PROGRAM NAME

BOOTB

ASSEMBLES PROGRAMS SET AND MTLD.
STORES THEM IN BANK 16

PROGRAM CONTROL WORDS

BOOTBA	LOW ORDER OF 4 BIT WORD
BOOTBB	HIGH ORDER OF 4 BIT WORD
BOOTBC	TEMPORARY STORING BUILDING WORD
BOOTBD	AREA FOR STORING 8 BIT WORD
BOOTBE	CROSSING A 4-BIT WORD BANK
BOOTBF	LOAD AREA FOR 4-BIT WORDS
BOOTBG	COMPLETION TEST

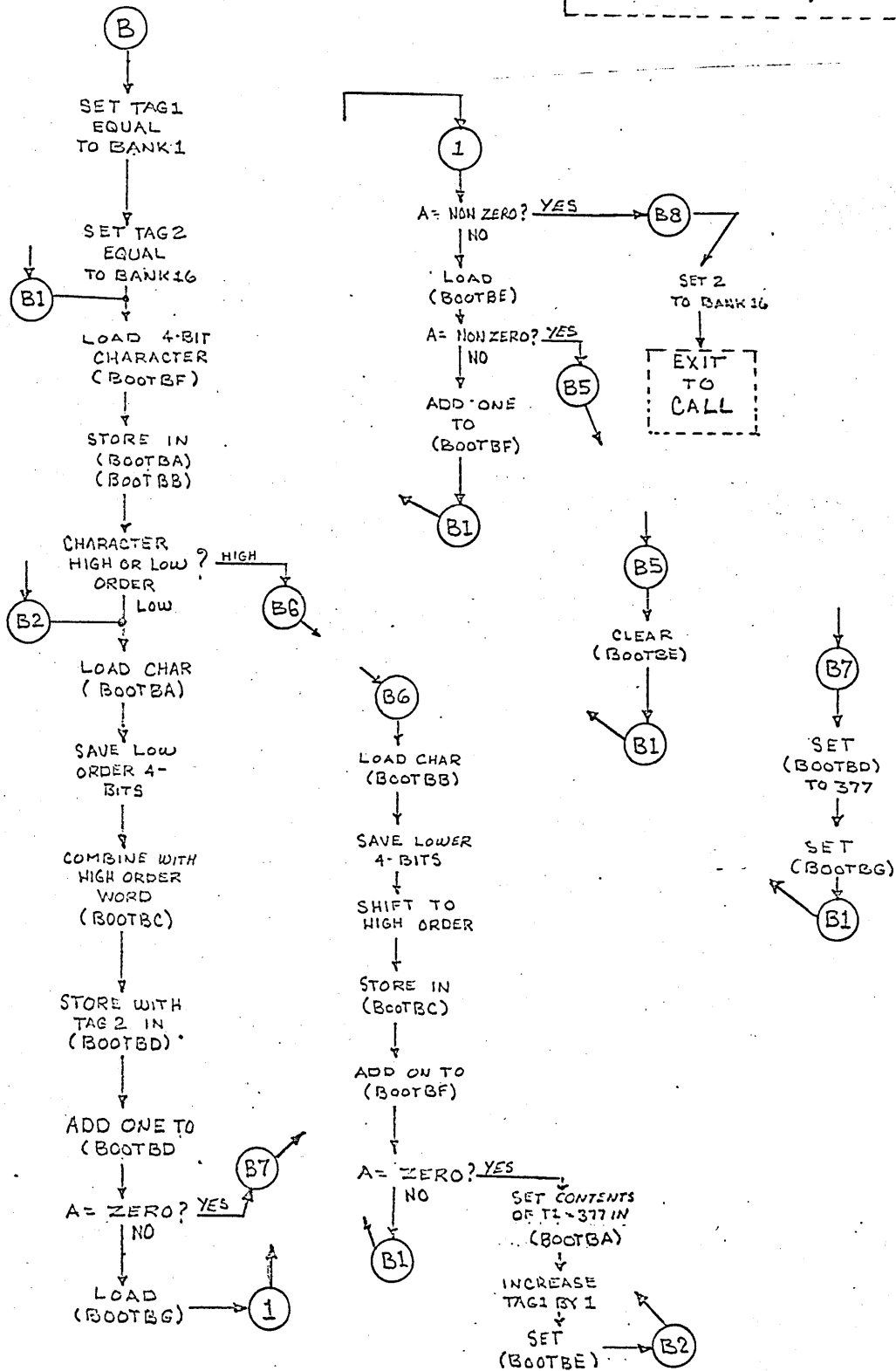

0000 PRG 0

```

*****
***** PROGRAM NAMES *****
*
*          BOOTBH          *
*
* 6BIT INSTRUCTION PROGRAM *
*  ASSEMBLES AND 8BIT    *
*  INSTRUCTION PROGRAM   *
*    CALLED BOOTB       *
*
*          BOOTB          *
*
* 8BIT INSTRUCTION PROGRAM *
*  ASSEMBLES AND 8BIT    *
*  INSTRUCTION WORD      *
*  STORES THEM IN HIGH  *
***** CORE *****
*****

```

0000	0021	BOOTBH	LDM		
0001	0056	BOOTBI		BOOTB	
0002	0041		STM		
0003	0013			BOOTBJ	
0004	0041		STM		
0005	0033			BOOTBM	
0006	0010		LPN		
0007	0020			20	
0010	0060		ZJP		
0011	0032			BOOTBL	
0012	0020		LDN		
0013	0000	BOOTBJ			** LOAD HIGH ORDER OF WORD
0014	0010		LPN		
0015	0017			17	
0016	0001		SHA		
0017	0001		SHA		
0020	0001		SHA		
0021	0001		SHA		
0022	0041		STM		
0023	0046			BOOTBO	
0024	0055	BOOTBK	RAO		** INCREASE START ADDRESS BY ONE
0025	0001			BOOTBI	
0026	0061		NZP		
0027	0000			BOOTBH	
0030	0064		UJP		
0031	0056			BOOTB	
0032	0020	BOOTBL	LDN		** LOAD LOW ORDER OF WORD
0033	0000	BOOTBM			** PRESTORED WORD
0034	0010		LPN		

0035	0017			17	
0036	0015		LSM		
0037	0046			BOOTBO	
0040	0041		STM		
0041	0056	BOOTBN		BOOTB	** STORE WORD, INCREASE
0042	0055		RAO		STORE AREA BY ONE
0043	0041			BOOTBN	
0044	0064		UJP		
0045	0024			BOOTBK	
0046	0000	BOOTB0			** STORE AREA FOR BUILDING WORD
0047	0000	BOOTBA			** LOWER ORDER OF WORD
0050	0000	BOOTBB			HIGH ORDER OF WORD
0051	0000	BOOTBC			** STORE AREA FOR BUILDING WORD
0052	0000	BOOTBD			** AREA FOR STORING WORD
0053	0000	BOOTBE			** CROSSING OF BANK
0054	0000	BOOTBF			** START ADDRESS OF INPUT
0055	0000	BOOTBG			** TEST FOR COMPETATION
0056	0020	BOOTB	LDN		
0057	0001			1	
0060	0102		ATT	T1	
0061	0020		LDN		
0062	0016			16	
0063	0202		ATT	T2	
0064	0122	BOOTBI	LDI	T1	** ADDRESS OF NEXT CHARACTER
0065	0054			BOOTBF	
0066	0041		STM		
0067	0047			BOOTBA	
0070	0041		STM		
0071	0050			BOOTBB	
0072	0010		LPN		
0073	0020			20	
0074	0061		NZP		
0075	0133			BOOTB6	
0076	0021	BOOTB2	LDM		** LOWER ORDER OF WORD
0077	0047			BOOTBA	
0100	0010		LPN		
0101	0017			17	
0102	0015		LSM		
0103	0051			BOOTBC	
0104	0242	BOOTB3	STI	T2	** STORE BUILT CHARACTER
0105	0052			BOOTBD	
0106	0055		RAO		
0107	0052			BOOTBD	
0110	0060		ZJP		
0111	0165			BOOTB7	
0112	0021		LDM		
0113	0055			BOOTBG	
0114	0061		NZP		

0115	0175			BOOTB8	
0116	0021	BOOTB4	LDM	BOOTBE	** TEST IF CROSSING BANK
0117	0053			BOOTBE	
0120	0061		NZP		
0121	0126			BOOTB5	
0122	0055		RAO		
0123	0054			BOOTBF	
0124	0064		UJP		
0125	0064			BOOTBI	
0126	0003	BOOTB5	TTA		** CROSSING OF BANK
0127	0041		STM		
0130	0053			BOOTBE	
0131	0064		UJP		
0132	0064			BOOTBI	
0133	0021	BOOTB6	LDM		** HIGH ORDER OF CHARACTER
0134	0050			BOOTBB	
0135	0010		LPN		
0136	0017			17	
0137	0001		SHA		
0140	0001		SHA		
0141	0001		SHA		
0142	0001		SHA		
0143	0041		STM		
0144	0051			BOOTBC	
0145	0055		RAO		
0146	0054			BOOTBF	
0147	0061		NZP		
0150	0064			BOOTBI	
0151	0121		LDM	TI	
0152	0377			377	
0153	0041		STM		
0154	0047			BOOTBA	
0155	0103		TTA	TI	
0156	0030		ADN		
0157	0001			I	
0160	0102		ATT	TI	
0161	0055		RAO		
0162	0053			BOOTBE	
0163	0064		UJP		
0164	0076			BOOTB2	
0165	0020	BOOTB7	LDN		** SET STORE AREA TO 377
0166	0377			377	FOR NEXT CHARACTER
0167	0041		STM		
0170	0052			BOOTBD	
0171	0055		RAO		
0172	0055			BOOTBG	
0173	0064		UJP		
0174	0116			BOOTB4	

0175	0020	BOOT88	LDN	** SET TAG2 FOR JUMP
0176	0015			EXIT TO PROGRAM CALL
0177	0202		ATT	
0200	0264		UJP	
0201	7777			

BOOTCH and BOOTC FORMAT

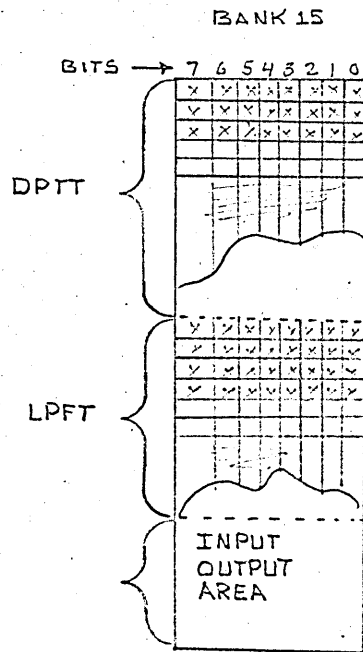
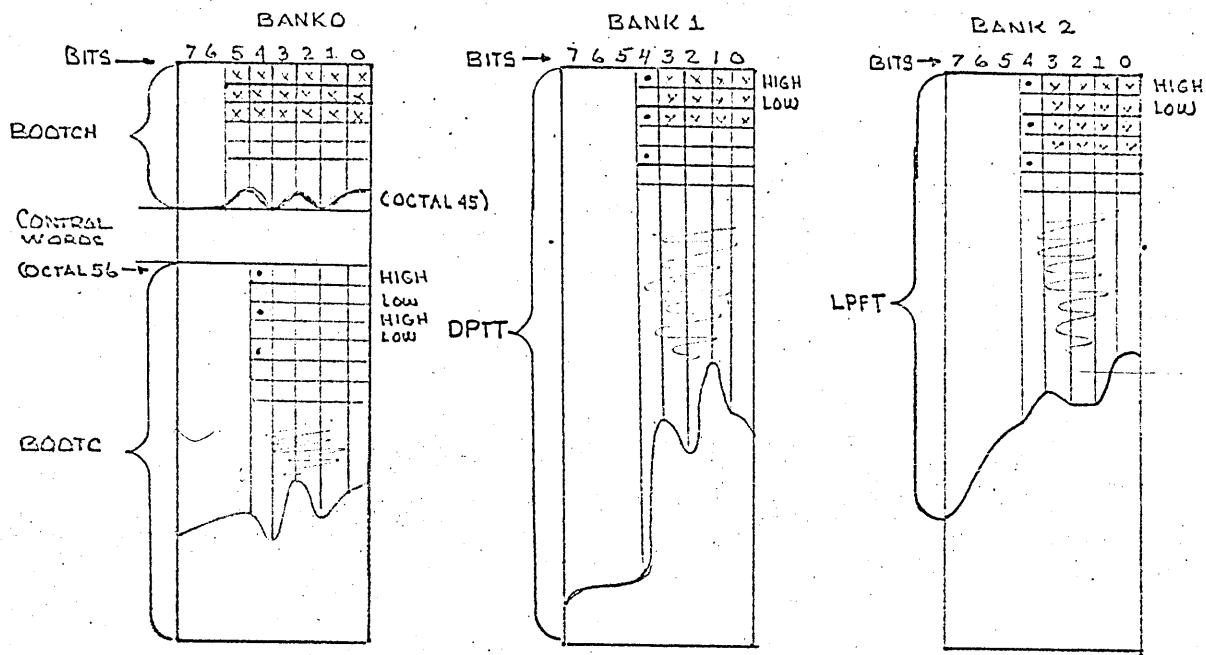

BOOTCH BANK-0 THE FIRST 45 (OCTAL) LOCATIONS ARE 6-BIT WORDS.
 BANK 0, FROM 56 (OCTAL) TO 376 OF BANK 2, THEY ARE 4-BIT
 WORDS WITH THE HIGH ORDER FOR AN 8-BIT WORD
 BEING IDENTIFIED BY BIT POSITION 4.

BANK 15 DPTT LPFT I/O AREA
 AFTER, THE 4-BIT WORDS ARE ASSEMBLED INTO 8-BIT WORDS

BOOTCH AND BOOTC

I. Function

A. General

To store the remaining part of the program DPTT along with the program LDFT into bank 15, then will exit to Program CALL.

B. Detail

BOOTCH and BOOTC is the last record of the BOOT STRAP which was loaded into the 8092B core by program CALL starting with address zero of bank zero.

BOOTCH is a set of six bit per word instructions, when executed, it builds a set of eight bit per word instructions from two four bit words.

This becomes program BOOTC.

BOOTC will take remaining four bit words, combine the high and the low orders to build and eight bit word and stores them into bank 15.

These eight bit words are program instructions belonging to DPTT and LPFT. Then it will exit to program CALL.

II. Control Tags

TAG 1. Used while combining the high and the low order of each word before storing.

TAG 2. First set to bank 15 to be used while storing programs DPTT and LPFT, then set for the exit to program CALL.

III. Control Words

BOOTCO Temporary storage for the building of the eight bit word.

BOOTCA Lower order of the eight bit word.

BOOTCB High order of the eight bit word.

BOOTCC Temporary storage for the building of the eight bit word.

BOOTCD Address for storing DPTT and LPFT.

BOOTCE Crossings of a bank.

BOOTCF Starting address of the four bit words.

BOOTCG Flag test for completion of storing DPTT and LPFT to their proper bank.

IV. Entry Point

BOOTCH

V. Exits

To program CALL

PROGRAM NAME

BOOTCH

IT ASSEMBLES A PROGRAM TO WORK WITH TAGS

PROGRAM CONTROL WORDS	
BOOTCI	START ADDRESS OF 4-BIT WORDS
" " CJ	HIGH ORDER OF WORD
" " CM	LOW ORDER OF WORD
" " CØ	TEMPORARY STORAGE
" " CN	START ADDRESS OF 2BIT WORDS
" " C	START OF PROGRAM BOOTC

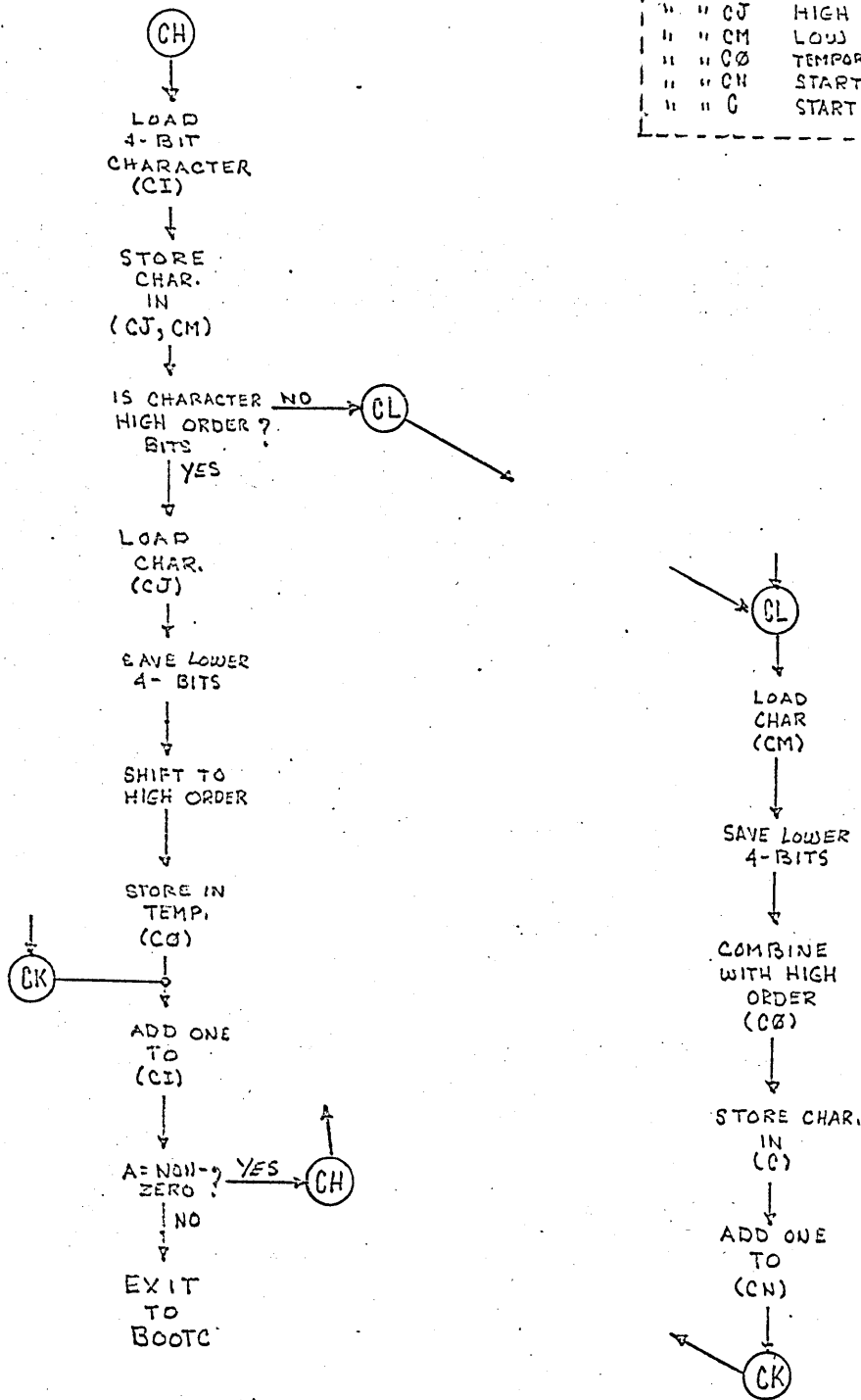

PROGRAM NAME

BOOTC

ASSEMBLES PROGRAMS DPTT AND LDFT
STORES THEM IN BANK 17

PROGRAM CONTROL WORDS	
BOOTCA	LOW ORDER OF 4 BIT WORD
BOOTCB	HIGH ORDER OF 4 BIT WORD
BOOTCC	TEMPORARY STORING BUILDING WORD
BOOTCD	AREA FOR STORING 8 BIT WORD
BOOTCE	CROSSING A 4 BIT WORD BANK
BOOTCF	LOADING AREA FOR 8 BIT WORD
BOOTCG	COMPLETION TEST

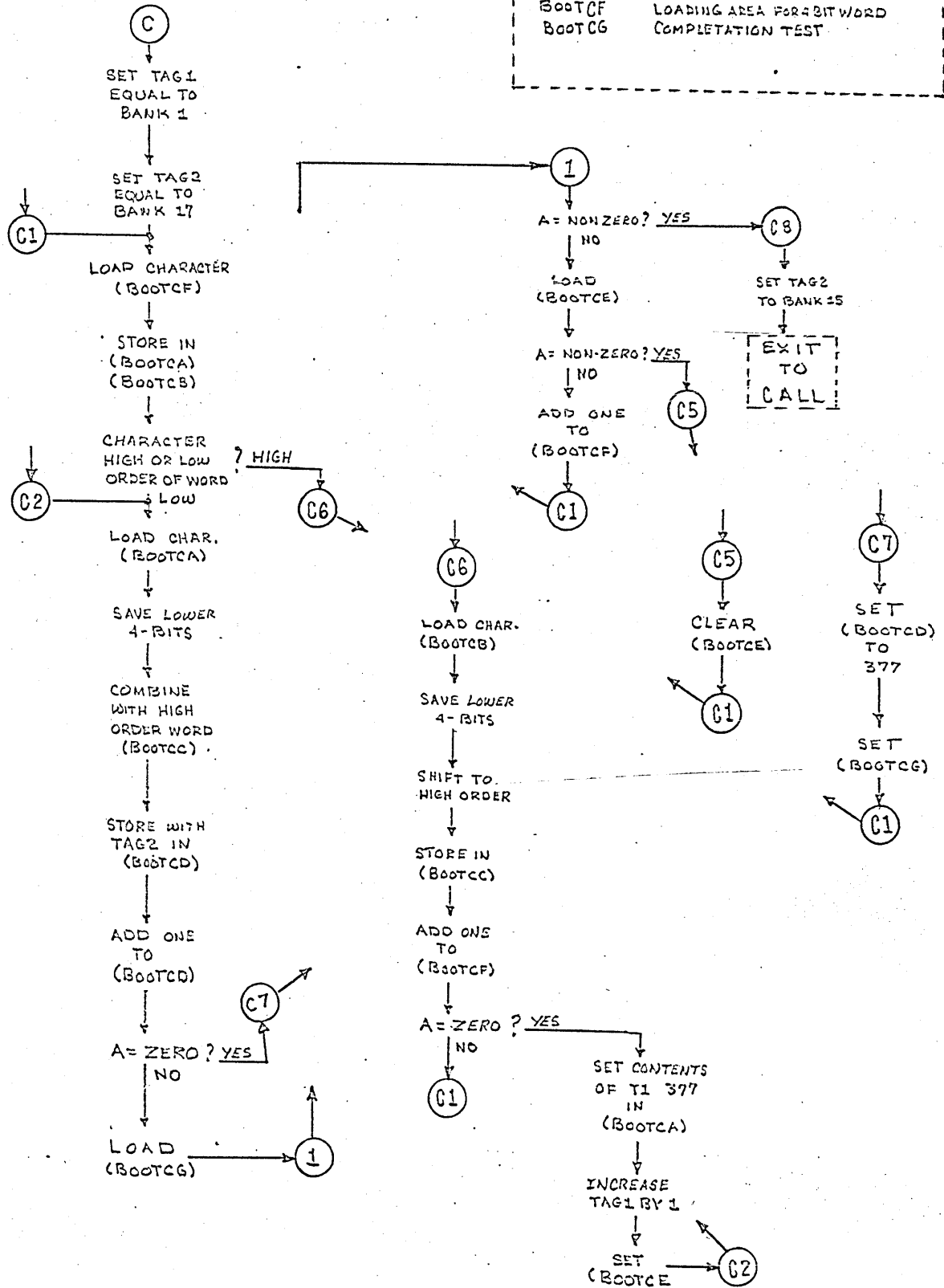

0000 PRG 0

```

*****
***** PROGRAM NAMES *****
*
*       BOOTCH
*
* 6BIT INSTRUCTION PROGRAM
* ASSEMBLES AND 8BIT
* INSTRUCTION PROGRAM
* CALLED BOOTC
*
*       BOOTC
*
* 8BIT INSTRUCTION PROGRAM
* ASSEMBLES AND 8BIT
* INSTRUCTION WORD
* STORES THEM IN HIGH
***** CORE *****
*****
    
```

0000	0021	BOOTCH	LDM		
0001	0056	BOOTCI		BOOTC	
0002	0041		STM		
0003	0013			BOOTCJ	
0004	0041		STM		
0005	0033			BOOTCM	
0006	0010		LPN		
0007	0020			20	
0010	0060		ZJP		
0011	0032			BOOTCL	
0012	0020		LDN		
0013	0000	BOOTCJ			** LOAD HIGH ORDER WORD
0014	0010		LPN		
0015	0017			17	
0016	0001		SHA		
0017	0001		SHA		
0020	0001		SHA		
0021	0001		SHA		
0022	0041		STM		
0023	0046			BOOTCO	
0024	0055	BOOTCK	RAO		** INCREASE START ADDRESS BY ONE
0025	0001			BOOTCI	
0026	0061		NZP		
0027	0000			BOOTCH	
0030	0064		UJP		
0031	0056			BOOTC	
0032	0020	BOOTCL	LDN		** LOAD LOW ORDER OF WORD
0033	0000	BOOTCM			** PRESTORED WORD
0034	0010		LPN		

0035	0017		17	
0036	0015	LSM		
0037	0046		BOOTCO	
0040	0041	STM		
0041	0056	BOOTCN	BOOTC	** STORE WORD INCREASE
0042	0055	RAO		STORE AREA BY ONE
0043	0041		BOOTCN	
0044	0064	UJP		
0045	0024		BOOTCK	
0046	0000	BOOTCO		** STORE AREA FOR BUILDING WORD
0047	0000	BOOTCA		** LOWER ORDER OF WORD
0050	0000	BOOTCB		** HIGH ORDER OF WORD
0051	0000	BOOTCC		** STORE AREA FOR BUILDING WORD
0052	0000	BOOTCD		** AREA FOR STARTING WORD
0053	0000	BOOTCE		** CROSSING A BANK
0054	0000	BOOTCF		** START ADDRESS OF INPUT
0055	0000	BOOTCG		** TEST FOR COMPLETATION
0056	0020	BOOTC	LDN	
0057	0001		1	
0060	0102	ATT	T1	
0061	0020	LDN		
0062	0017		17	
0063	0202	ATT	T2	
0064	0122	BOOTCI	T1	** ADDRESS OF NEXT CHARACTER
0065	0054		BOOTCF	
0066	0041	STM		
0067	0047		BOOTCA	
0070	0041	STM		
0071	0050		BOOTCB	
0072	0010	LPN		
0073	0020		20	
0074	0061	NZP		
0075	0133		BOOTC6	
0076	0021	BOOTC2	LDM	** LOWER ORDER OF WORD
0077	0047		BOOTCA	
0100	0010	LPN		
0101	0017		17	
0102	0015	LSM		
0103	0051		BOOTCC	
0104	0242	BOOTC3	STI	** STORE BUILT CHARACTER
0105	0052		BOOTCD	
0106	0055	RAO		
0107	0052		BOOTCD	
0110	0060	ZJP		
0111	0165		BOOTC7	
0112	0021	LDM		
0113	0055		BOOTC6	
0114	0061	NZP		

0115	0175			BOOTC8	
0116	0021	BOOTC4	LDM	BOOTCE	** TEST IF CROSSING BANKS
0117	0053			BOOTCE	
0120	0061		NZP		
0121	0126			BOOTC5	
0122	0055		RAO		
0123	0054			BOOTCF	
0124	0064		UJP		
0125	0064			BOOTCI	
0126	0003	BOOTC5	TTA		** CROSSING OF A BANK
0127	0041		STM		
0130	0053			BOOTCE	
0131	0064		UJP		
0132	0064			BOOTCI	
0133	0021	BOOTC6	LDM		** HIGH ORDER OF CHARACTER
0134	0050			BOOTCB	
0135	0010		LPN		
0136	0017			17	
0137	0001		SHA		
0140	0001		SHA		
0141	0001		SHA		
0142	0001		SHA		
0143	0041		STM		
0144	0051			BOOTCC	
0145	0055		RAO		
0146	0054			BOOTCF	
0147	0061		NZP		
0150	0064			BOOTCI	
0151	0121		LDM	TI	
0152	0377			377	
0153	0041		STM		
0154	0047			BOOTCA	
0155	0103		TTA	TI	
0156	0030		ADN		
0157	0001			I	
0160	0102		ATT	TI	
0161	0055		RAO		
0162	0053			BOOTCE	
0163	0064		UJP		
0164	0076			BOOTC2	
0165	0020	BOOTC7	LDN		** SET STORE AREA TO 377
0166	0377			377	FOR NEXT CHARACTER
0167	0041		STM		
0170	0052			BOOTCD	
0171	0055		RAO		
0172	0055			BOOTCG	
0173	0064		UJP		
0174	0116			BOOTC4	

0175	0020	B00TC8	LDN	** SET TAG2 FOR JUMP
0176	0015			EXIT TO PROGRAM CALL
0177	0202		ATT	I5
0200	0264		UJP	T2
0201	7777			T2
				CALL

PROGRAM COPY

FORMAT

AUTOMATIC LOAD AND DUMP TAPE

RECORD NO. 1

BOOTAH	BOOTA	PROGRAMS, COPY AND CALL
--------	-------	-------------------------

RECORD NO. 2

BOOTBH	BOOTB	PROGRAMS, SET, MTL D AND PART OF DPTT
--------	-------	---------------------------------------

RECORD NO. 3

BOOTCH	BOOTC	PROGRAMS, DPTT AND LPFT	INPUT OUTPUT AREA
--------	-------	-------------------------	-------------------------

BOOT
STRAP
FILE

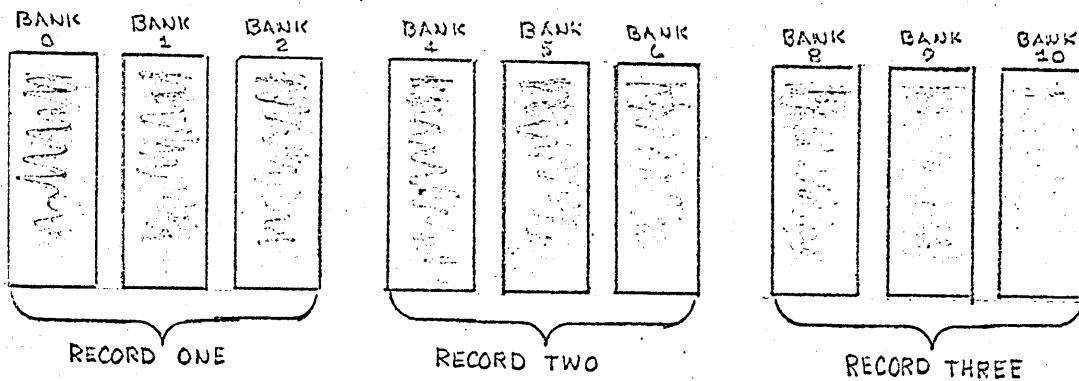

FROM → AUTOMATIC LOAD AND DUMP TAPE

READS RECORD ONE INTO BANKS 0, 1 AND 2. READS RECORD TWO INTO BANKS 4, 5 AND 6

READS RECORD THREE INTO BANKS 8, 9 AND 10.

TO NEW MAGNETIC TAPE

OUTPUTS BANKS 0, 1 AND 2 (RECORD ONE) OUTPUTS BANKS 4, 5 AND 6 (RECORD TWO)

OUTPUTS BANKS 8, 9 AND 10 (RECORD THREE). WRITES EOF AND CODE MARK (77)

THE TAPE IS NOW AN AUTOMATIC LOAD AND DUMP TAPE.

COPY

I. Function

A. General

Generates the BOOT STRAP for a new Automatic Load and Dump Tape.

B. Detail

Reads the three records of the BOOT STRAP into the 8092B core on the buffer channel. Record one of the BOOT STRAP is stored starting with zero of bank 0, to word 377 of bank 2. Record two is stored starting with word zero of bank 4, to word 377 of bank 6. Record three is stored starting with word zero of bank 8, to word 377 of bank 10. Then the program halts, so a new tape can be mounted on unit 3.

COPY writes the three records (which were stored into the 8092B core) on the buffer channel to the magnetic tape, that was mounted on unit 3, in the same sequence that they were inputted. Then it writes an end of file mark and code mark (77 octal). This tape is now a new Automatic Load and Dump Tape.

II. TAGS

TAG1 NOT USED.

TAG2 Programs execution tag.

TAG3 Used for input and output of the BOOT STRAP.

III. CONTROL WORDS

COPY A Counter for parity error while reading or writing.

COPY B Times counter of 3, for input and output.

COPY C Times counter of 2, for input and outputting the three records, just once.

COPY 4 Prestored number to increase Tag 3.

COPY 7 Prestored code for reading or writing.

COPY 8 Prestored code for inputting or outputting.

IV. ENTRY POINTS

COPY Entry point for program CALL.

EXIT

NONE.

PROGRAM NAME

COPY

COPY BOOT STRAP ON TAPE

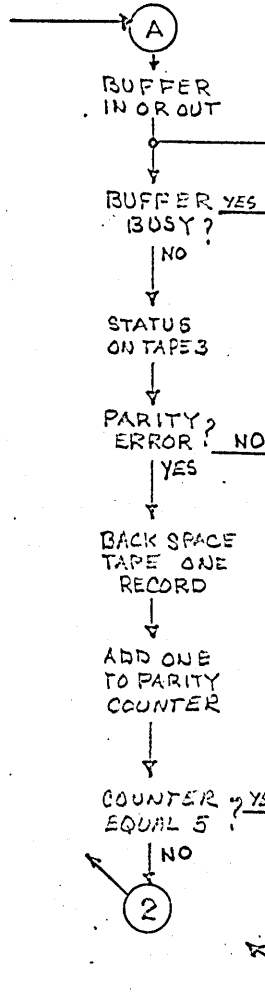
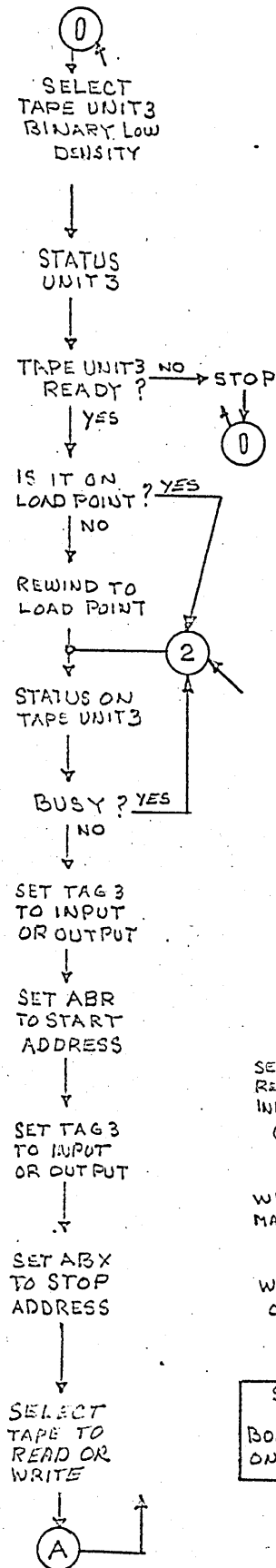

PROGRAM CONTROL WORDS	
COPY A	COUNTER FOR PARITY ERRORS
COPY B	TIMES COUNTER INPUT, OUTPUT
COPY C	SWITCH FOR INPUT OUTPUT
COPY 4	TO INCREASE TAG 3
COPY 7	TO WRITE OR READ DATA
COPY 8	INPUT, OUTPUT BUFFER CHANNEL

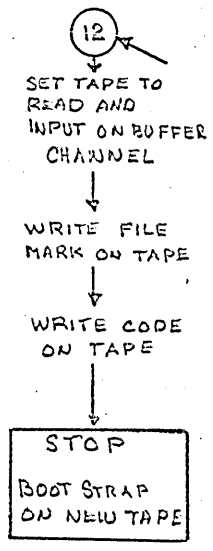
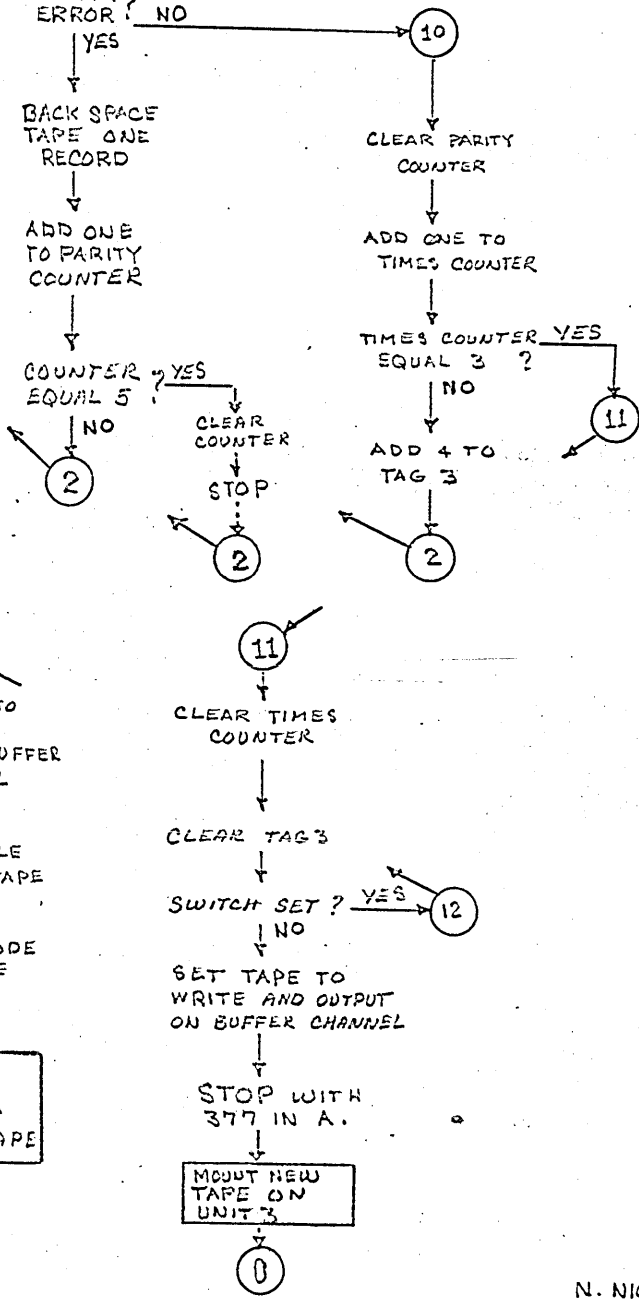

6400 SUPB
PRG 6400

```

*****
*** PROGRAM NAME ***
*
* COPY *
*
* IT GENERATES THE *
* BOOT STRAP ON A *
* NEW TAPE *
***
*****
    
```

6400	0075	COPY	EXF		
6401	0013			TAPE3	
6402	0011			SOL	
6403	0075		EXF		
6404	0013			TAPE3	
6405	0000			RS0	
6406	0076		INA		
6407	0010		LPN		
6410	0042			42	
6411	0034		SBN		
6412	0040			40	
6413	0260		ZJP	T2	
6414	6427			COPY2	
6415	0030		ADN		
6416	0040			40	
6417	0260		ZJP	T2	
6420	6424			COPY1	
6421	0077		HLT		
6422	0264		UJP	T2	
6423	6400			COPY	**TAPE UNIT 3 NOT READY
6424	0075	COPY1	EXF		**REWIND TAPE UNIT 3 LOAD POINT
6425	0013			TAPE3	
6426	0034			RWL	
6427	0075	COPY2	EXF		**TAKE STATUS OF TAPE UNIT 3
6430	0013			TAPE3	
6431	0000			RS0	
6432	0076		INA		
6433	0263		NJP	T2	
6434	6427			COPY2	
6435	0020		LDN		
6436	0000	COPY4		0	**SET T3 FOR INPUT OUTPUT F.W.T.
6437	0302		ATT	T3	
6440	0020		LDN		
6441	0000			0	
6442	0204	COPY5	ABR	T2	**IF BUSY, KEEP TRYING TO ENTER STAR
6443	6442			COPY5	ADDRESS FOR INPUT OR OUTPUT

6444	0303		TTA	T3	
6445	0030		ADN		
6446	0003			3	
6447	0302		ATT	T3	
6450	0020		LDN		
6451	0002			2	
6452	0205	COPY6	ABX	T2	**IF BUSY, KEEP TRYING TO ENTER STOP
6453	6452			COPY6	ADDRESS FOR INPUT OR OUTPUT
6454	0075		EXF		
6455	0013			TAPE3	
6456	0024	COPY7		READ	**THIS CHANGES TO READ AND WRITE
6457	0270	COPY8	IBI	T2	**THIS CHANGES TO INPUT OR OUTPUT
6460	6457			COPY8	
6461	0020		LDN		BUFFER CHANNEL IBI, IBO
6462	0000			0	
6463	0204	COPY9	ABR	T2	**TEST POINT FOR COMPLETION OF BUFFER
6464	6463			COPY9	
6465	0075		EXF		
6466	0013			TAPE3	
6467	0000			RS0	
6470	0076		INA		
6471	0010		LPN		
6472	0004			4	
6473	0260		ZJP	T2	
6474	0513			COPY10	
6475	0075		EXF		
6476	0013			TAPE3	
6477	0031			SBR	
6500	0255		RA0	T2	
6501	6606			COPYA	
6502	0034		SBN		
6503	0005			5	
6504	0261		NZP	T2	
6505	6427			COPY2	
6506	0241		STM	T2	
6507	6606			COPYA	
6510	0077		HLT		
6511	0264		UJP	T2	
6512	6427			COPY2	
6513	0241	COPY10	STM	T2	**CLEAR PARITY CHECK COUNTER
6514	6606			COPYA	
6515	0255		RA0	T2	
6516	6607			COPYB	
6517	0034		SBN		
6520	0003			3	
6521	0260		ZJP	T2	
6522	6531			COPY11	
6523	0020		LDN		

6524	0004			4	
6525	0251		RAM	T2	
6526	6436			COPY4	
6527	0264		UJP	T2	
6530	6427			COPY2	
6531	0241	COPY11	STM	T2	**CLEAR TIMES COUNTER, FOR INPUT
6532	6607			COPYB	ON OUTPUT
6533	0241		STM	T2	
6534	6436			COPY4	
6535	0221		LDM	T2	
6536	6610			COPYC	
6537	0001		SHA		
6540	0241		STM	T2	
6541	6610			COPYC	
6542	0263		NJP	T2	
6543	6564			COPY12	
6544	0020		LDN		
6545	0271		IBO	T2	
6546	0241		STM	T2	
6547	6457			COPY8	
6550	0020		LDN		
6551	0020			WRT	
6552	0241		STM	T2	
6553	6456			COPY7	
6554	0075		EXF		
6555	0013			TAPE3	
6556	0035			RWU	
6557	0020		LDN		
6560	0377			377	
6561	0077		HLT		**PUT NEW TAPE ON UNIT 3 AND RUN
6562	0264		UJP	T2	
6563	6400			COPY	
6564	0020	COPY12	LDN		**SET COPY 4 TO INPUT ON BUFFER
6565	0270		IBI	T2	
6566	0241		STM	T2	
6567	6457			COPY8	
6570	0020		LDN		
6571	0024			READ	
6572	0241		STM	T2	
6573	6456			COPY7	
6574	0075		EXF		
6575	0013			TAPE3	
6576	0021			WFM	
6577	0075		EXF		
6600	0013			TAPE3	
6601	0020			WRT	
6602	0074		OTN		
6603	0077			77	

6604	0003		TTA	
6605	0077		HLT	
6606	0000	COPYA		**BOOT STRAP ON NEW TAPE UNIT 3
6607	0000	COPYB		**COUNTER FOR PARITY CHECK
6610	0252	COPYC	252	**TIMES COUNTER FOR INPUT OUTPUT
				**SWITCH FOR READING OR WRITING

PROGRAM CALL FORMAT

AUTOMATIC LOAD AND DUMP TAPE

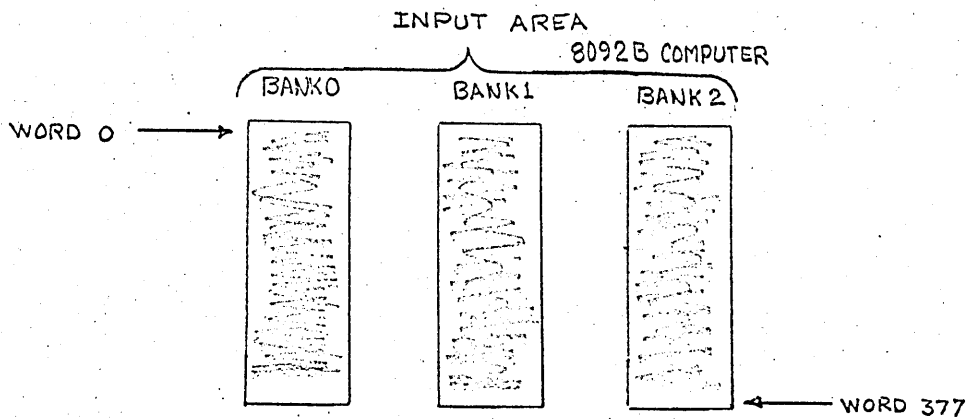
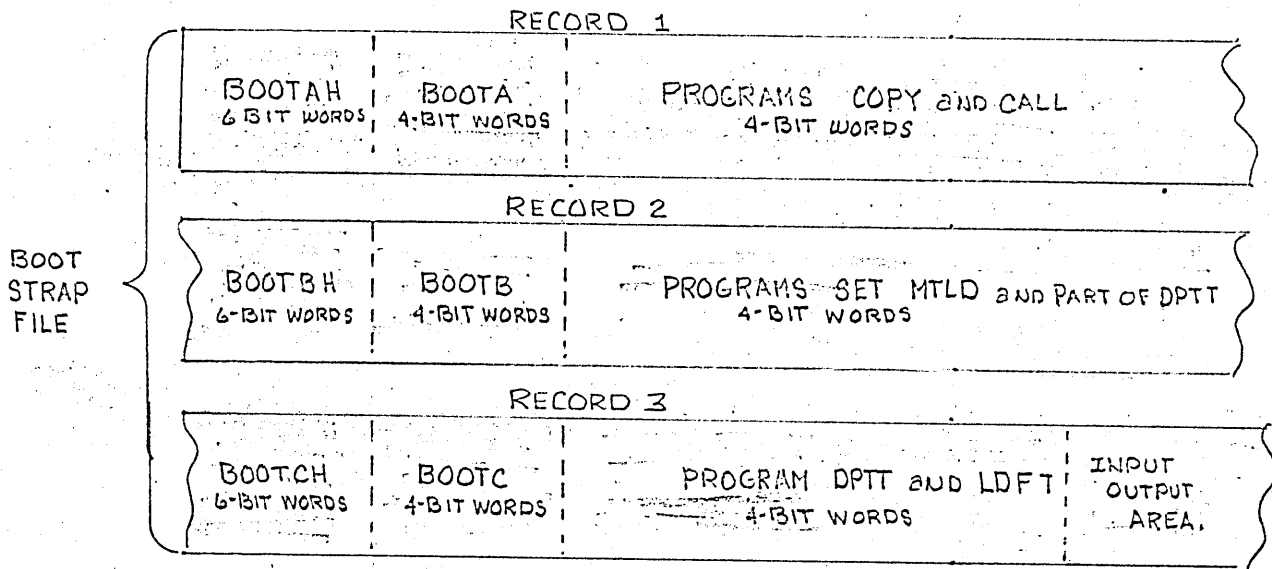

RECORD TWO IS INPUTTED FIRST THEN PROCESSED BY PROGRAM BOOTBH.
RECORD THREE IS INPUTTED AND PROCESSED BY PROGRAM BOOTCH.

BOTH RECORDS START IN BANK 0 WORD 0 AND END IN BANK 2 WORD 377.

CALL

I. Function

A. General

CALL brings in records two and three of the BOOT STRAP into the 8092B Core for processing.

B. Detail

The buffer channel is used to input the records. The input area starts with word zero of bank zero and ends with word 377 octal of bank two. Record two is input first, then CALL releases control to BOOTBH for the processing of record two from the BOOTSTRAP file.

When the processing of record two is completed BOOTBH will return control back to program CALL. CALL will input record three of the BOOT STRAP in the same manner as record two. Control is then returned to BOOTCH for the processing of record three. BOOTCH will return control to program CALL when the processing is completed.

A parity check is made on both of the records. CALL then comes to a halt to indicate that the BOOT STRAP is now loaded and ready for its job assignments. The job assignments are indicated by entering a parameter in to the A-REGISTER.

The parameter is divided into four bit indicators. The high order four bits are for copying the BOOT STRAP or to dump a program from the 8092B Core to the Automatic Load and Dump Tape. The low order bits indicates the file number on the Automatic Load and Dump Tape either for the loading or the dumping of the 8092B core.

DUMP OR COPY HIGH	FILE NUMBER LOW	Parameter job assignments
17	0	Generates a new Automatic Load any Dump Tape, Dumping of the 8092B Core to the Automatic Load and Dump Tape.
XX	0	
XX	YY	Loading the 8092B core from the Automatic Load and Dump Tape.
0	YY	

II. TAGS

TAG1 Exit tag to programs BOOTBH and BOOTCH

TAG2 Programs execution tag, also exit tag to Programs SET and COPY

TAG3 Records two and three input tag.

III. Control Words

CALLA Switch Counter for inputting only two records

CALLB Parity error counter

CALL10 Job assignment word.

IV. Entry Point

CALL

V. Exits

BOOTBH

BOOTCH

SET

COPY

PROGRAM NAME

CALL

CALL BOOT STRAPS 2 and 3

PROGRAM CONTROL WORDS

CALLA — SWITCH TEST, FOR BOOT STRAP
CALLB — PARITY ERROR COUNTER
CALL 10 — FILE NO. CALLED FOR

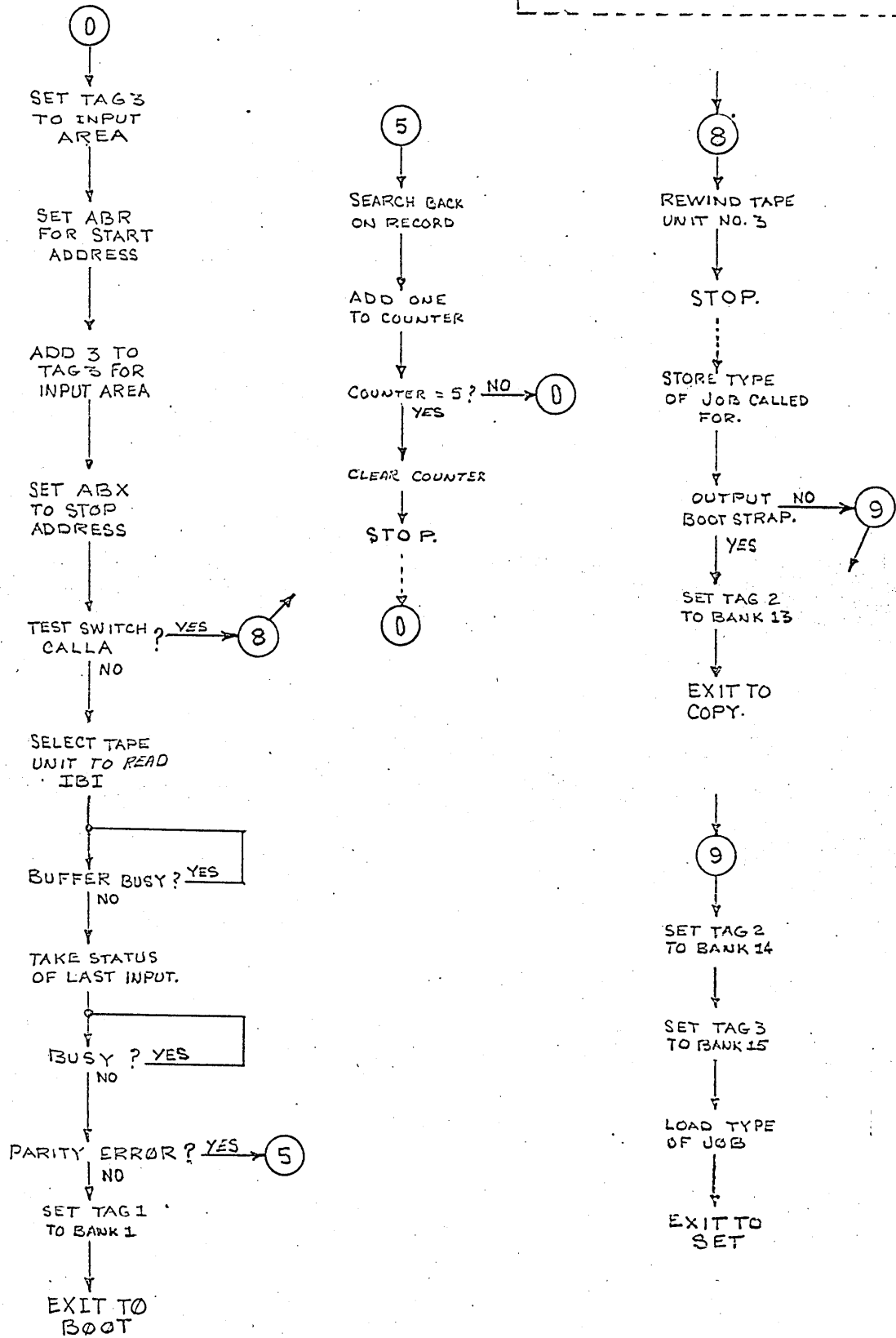

```

*****
*** PROGRAM NAME ***
*
*   CALL
*
* BRINGS IN BOOTBH
* AND BOOTCH OFF OF
*   TAPE
* TO COMPLETE THE
* LOADING OF THE
*   BOOT STRAP
***
*****

```

6611	0020	CALL	LDN		
6612	0000			0	
6613	0302		ATT	T3	
6614	0204	CALL1	ABR	T2	**SET START ADDRESS FOR INPUT
6615	6614			CALL1	
6616	0030		ADN		
6617	0003			3	
6620	0302		ATT	T3	
6621	0020		LDN		
6622	0002			2	
6623	0205	CALL2	ABX	T2	**SET STOP ADDRESS FOR INPUT
6624	6623			CALL2	
6625	0221		LDM	T2	
6626	6744			CALLA	
6627	0001		SHA		
6630	0241		STM	T2	
6631	6744			CALLA	
6632	0263		NJP	T2	
6633	6712			CALL8	
6634	0075		EXF		
6635	0013			TAPE3	
6636	0024			READ	
6637	0270	CALL2A	IBI	T2	** READ NEXT RECORD FROM BOOT STRAP
6640	6637			CALL2A	
6641	0020		LDN		
6642	0000			0	
6643	0204	CALL3	ABR	T2	**WAIT TILL BUFFER IS COMPLETED
6644	6643			CALL3	
6645	0075	CALL4	EXF		**STATUS OF LAST INPUT
6646	0013			TAPE3	
6647	0000			RS0	
6650	0076		INA		
6651	0263		NJP	T2	
6652	6645			CALL4	
6653	0010		LPN		

6654	0004			4	
6655	0261		NZP	T2	
6656	6664			CALL5	
6657	0241		STM	T2	
6660	6745			CALLB	
6661	0102		ATT	T1	
6662	0164		UJP	T1	
6663	0000			0	
6664	0075	CALL5	EXF		** BACK SPACE ON RECORD
6665	0013			TAPE3	
6666	0031			SBR	
6667	0255		RAO	T2	
6670	6745			CALLB	
6671	0034		SBN		
6672	0005			5	
6673	0260		ZJP	T2	
6674	6705			CALL7	
6675	0075	CALL6	EXF		** STATUS OF TAPE UNIT3
6676	0013			TAPE3	
6677	0000			RS0	
6700	0076		INA		
6701	0263		NJP	T2	
6702	6675			CALL6	
6703	0264		UJP	T2	
6704	6611			CALL	
6705	0241	CALL7	STM	T2	** CLEAR PARITY COUNTER
6706	6745			CALLB	
6707	0077		HLT		
6710	0264		UJP	T2	
6711	6675			CALL6	
6712	0075	CALL8	EXF		** REWIND TAPE3 TO LOAD POINT
6713	0013			TAPE3	
6714	0034			RWL	
6715	0003		TTA		
6716	0077		HLT		
6717	0241		STM	T2	
6720	6741			CALL10	
6721	0034		SBN		
6722	0360			360	
6723	0261		NZP	T2	
6724	6732			CALL9	
6725	0020		LDN		
6726	0015			15	
6727	0202		ATT	T2	
6730	0264		UJP	T2	
6731	6400			COPY	
6732	0020	CALL9	LDN		** SET BANKS IN TAG2 AND TAG3
6733	0016			16	

6734	0202		ATT	T2	
6735	0030		ADN		
6736	0001			I	
6737	0302		ATT	T3	
6740	0020		LDN		
6741	0000	CALLIO			** PRESTORE, LOADING OR DUMPING FILE
6742	0264		UJP	T2	
6743	7001			SET	
6744	0022	CALLA		22	** SWITCH TEST, FOR BOOTSTRAP.
6745	0000	CALLB			** PARITY ERROR COUNTER.

SET

I. Function

A. General

Executive program for the reading or the writing of the Automatic Load and Dump Tape for the 8092B core.

B. Detail

SET determines the job assignment by analyzing a "job Parameter" manually entered into A-register prior to execution. This "job parameter" is structured into two four bit indicators. The high order four bits are "bank" indicators, the low order four bits are "file" indicators.

The job assignment and job parameters can be derived from this "job parameters" as follows:

BANK	FILE	JOB ASSIGNEMENT AND PARAMETERS
0	YY	- Load file YY from Automatic Load and Dump Tape.
XX	00	- Dump 8092B core bank zero to bank XX and place on Automatic Load and Dump Tape as last file.
XX	YY	- Dump 8092B Core bank zero to bank XX and place on Automatic Load and Dump Tape as file YY.

NOTE: XX must be less than 17.

If the job assignment is dumping SET will: a) determine if the file to be dumped updates an existing file and set up the number of the file to be update b) determine if the file to be dumped is a new file to be added to the tape. It sets the control words for the last bank to be outputted and if the end of file mark and code mark octal 77, is to be put on the Automatic Load and Dump Tape to indicate the last file.

If the job assignment is loading, SET will determine the number of the file on magnetic tape to be loaded. It will clear the control word for the end of file and code mark.

SET initializes all control words, fixes program MTL D to either read or write and, exits to programs LPFT or DPTT depending on the job assignment.

II. TAGS

TAG1 Not used.
TAG2 Programs execution tag. Exit tag to program MTL D.
TAG3 Used for the inputting for a record, exit tag to program:
DPTT.

III. Control Words

AREA First word address of the input/output area.
NUMBER Number of the file record to be dumped.
FILE) The file number for dumping or loading the 8092B Core.
LAST Last bank + 1 for dumping the 8092B Core.
NOEOF To determine if E.O.F. and Core mark is to be output.
BANK Crossing of the banks while loading or dumping the 8092B Core.
CKSUM The adding of the eight-bit words while loading or dumping
the 8092B Core.
FLAG Indicates the last record of the file, for dumping the 8092B Core.

IV. Entry Points

SET

V. Exits

MTLD

DPTT

PROGRAM NAME

SET

SET TO A START CONDITION

PROGRAM CONTROL WORDS	
AREA NUMBER	FIRST WORD ADDRESS
FILE NOEOF	NUMBER OF FILE RECORDED
BANK	FILE NUMBER CALL FOR
CKSUM FLAG	LAST BANK +1 FOR DUMP
	FLAG TO WRITE E.O.F.
	CROSSING OF BANKS
	CHECK SUM OF PROGRAM
	FLAG FOR LAST RECORD FOR DUMP

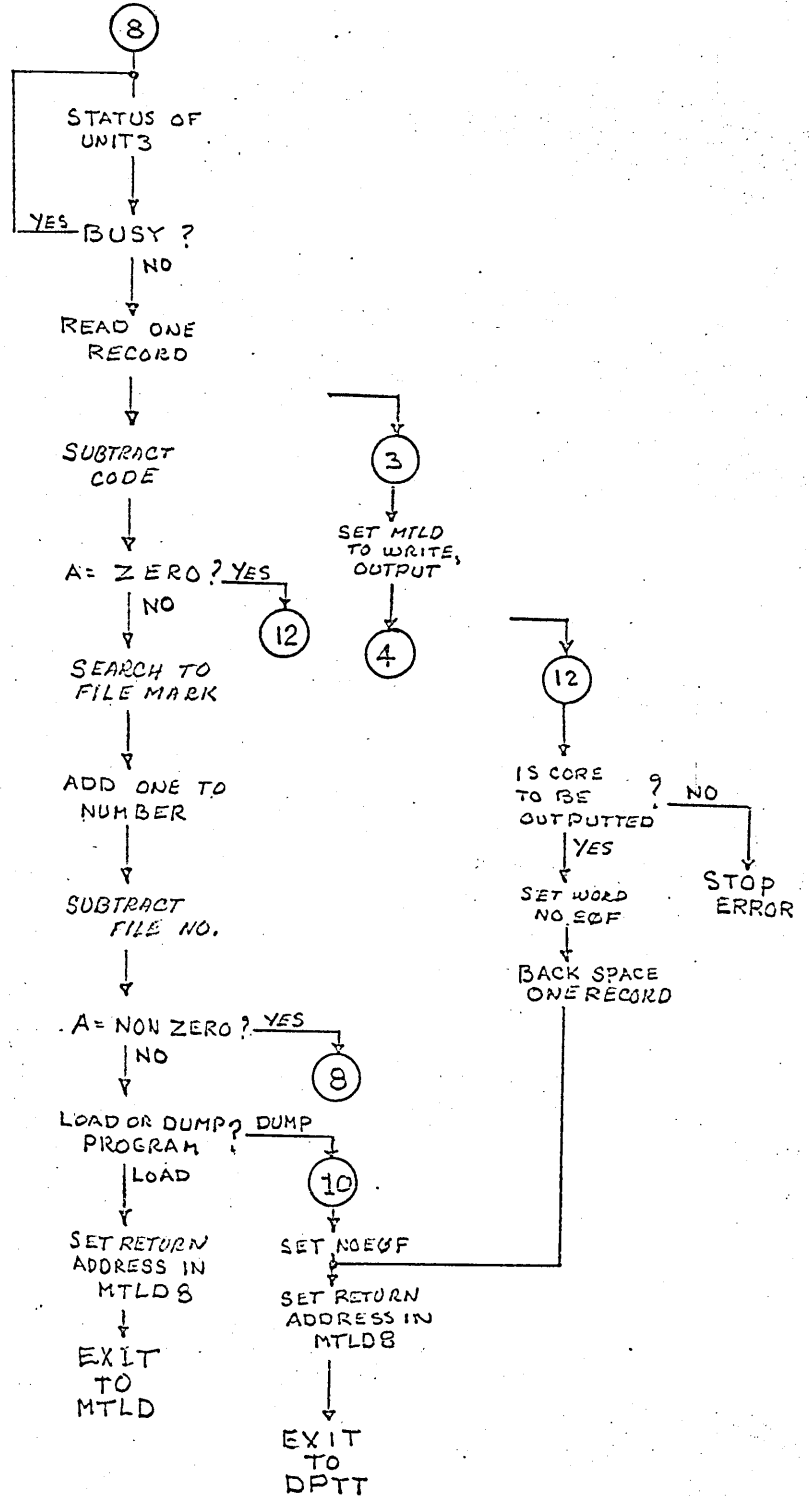
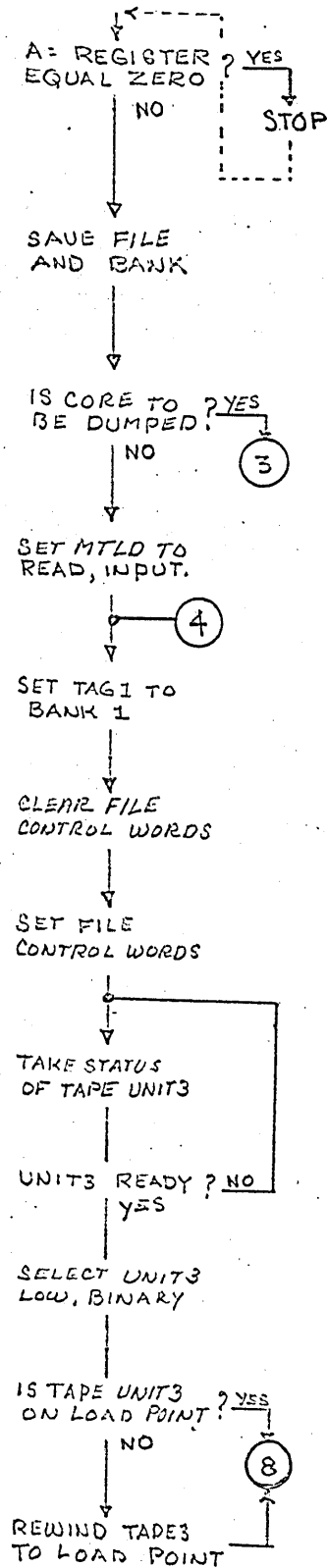

7000	PRG	7000
7000	0000	0
7001	0261 SET	T2
7002	7006	SET1
7003	0077	HLT
7004	0264	UJP
7005	7001	SET
7006	0241 SET1	STM
7007	7015	T2
7010	0010	SET2
7011	0017	LPN
7012	0241	17
7013	7213	STM
7014	0020	T2
7015	0000 SET2	FILE
7016	0010	LDN
7017	0360	LPN
7020	0001	360
7021	0001	SHA
7022	0001	SHA
7023	0001	SHA
7024	0341	SHA
7025	7664	STM
7026	0261	T3
7027	7042	LAST
7030	0020	T2
7031	0024	SET3
7032	0241	READ
7033	7232	T2
7034	0020	MTLD2
7035	0372	LDN
7036	0241	INNT3
7037	7233	T2
7040	0264	MTLD3
7041	7052	T2
		SET4

```

*****
*****
* PROGRAM NAME SET *
* *
* SET MTL D TO READ OR WRITE *
* CLEAR AND SET DATA FILE TO *
* START CONDICTION *
* *
*****
*****

```

```

** STOP A-REGISTER EQU LS
ZERO, NO JOB SPECIFIED.
IF YOU WISH TO CONTINUE
SPECIFIED JOB IN A-REGISTER
AND RUN.

```

```

** STORE LAST BANK

```

```

** STORE PROGRAM FILE NUMBER

```

7042	0020	SET3	LDN		** SET TAPE DRIVE TO WRITE
7043	0020			WRT	
7044	0241		STM	T2	
7045	7232			MTLD2	
7046	0020		LDN		
7047	0373			OUTT3	
7050	0241		STM	T2	
7051	7233			MTLD3	
7052	0003	SET4	TTA		** CLEAR AND SET DATA FILE WORDS
7053	0102		ATT	T1	
7054	0341		STM	T3	
7055	7660			BANK	
7056	0341		STM	T3	
7057	7566			LPFT3	
7060	0341		STM	T3	
7061	7661			CKSUM	
7062	0341		STM	T3	
7063	7665			FLAG	
7064	0241		STM	T2	
7065	7214			NUMBER	
7066	0241		STM	T2	
7067	7215			NOEOF	
7070	0075	SET5	EXF		** STATUS OF TAPE NO. 3
7071	0013			TAPE3	
7072	0000			RS0	
7073	0076		INA		
7074	0241		STM	T2	
7075	7111			SET7	
7076	0010		LPN		
7077	0002			2	
7100	0260		ZJP	T2	
7101	7105			SET6	
7102	0077		HLT		** STOP A-REGISTER EQUALS TWO, TAPE UNIT NOT READ. CORRECT CONDICTION AND RUN
7103	0264		UJP	T2	
7104	7070			SET5	
7105	0075	SET6	EXF		** SELECT TAPE BINARY LOW DENSITY
7106	0013			TAPE3	
7107	0011			SOL	
7110	0020		LDN		
7111	0000	SET7			** STORED STATUS OF TAPE NO. 3
7112	0010		LPN		
7113	0040			40	
7114	0261		NZP	T2	
7115	7121			SET8	
7116	0075		EXF		
7117	0013			TAPE3	

7120	0034			RWL	
7121	0075	SET8	EXF		** STATUS OF TAPE NO. 3
7122	0013			TAPE3	
7123	0000			RS0	
7124	0076		INA		
7125	0263		NJP	T2	
7126	7121			SET8	
7127	0075		EXF		
7130	0013			TAPE3	
7131	0024			READ	
7132	0372		INN	T3	
7133	7670			AREA	
7134	7770		+100	AREA	
7135	0321	SET9	LDM	T3	TEST FOR LAST FILE
7136	7670			AREA	
7137	0034		SBN		
7140	0077			77	
7141	0260		ZJP	T2	
7142	7177			SET12	
7143	0075		EXF		
7144	0013			TAPE3	
7145	0032			SFF	
7146	0255		RAO	T2	
7147	7214			NUMBER	
7150	0235		SBM	T2	
7151	7213			FILE	
7152	0261		NZP	T2	
7153	7121			SET8	
7154	0321		LDM	T3	
7155	7664			LAST	
7156	0261		NZP	T2	
7157	7166			SET10	
7160	0020		LDN		
7161	7541			LPFT	
7162	0241		STM	T2	
7163	7306			MTLD8	
7164	0264		UJP	T2	
7165	7222			MTLD1	
7166	0003	SET10	TTA		** CLEAR FLAG NO. EOF
7167	0241		STM	T2	
7170	7215			NOEOF	
7171	0020	SET11	LDN		** STORE ADDRESS FOR JUMP
7172	7410			DPTT3	
7173	0241		STM	T2	
7174	7306			MTLD8	
7175	0264		UJP	T2	
7176	7362			DPTT	
7177	0321	SET12	LDM	T3	** LOADING OR DUMPING PROGRAM

7200	7664			LAST	
7201	0261		NZP	T2	
7202	7204			SETI3	
7203	0077		HLT		** STOP A-REGISTER EQUALS ZERO, FILE CALLED FOR NOT ON TAPE -- NO RECOVERY RESTART.
7204	0241	SETI3	STM	T2	** SET FLAG FOR EOF
7205	7215			NOEOF	
7206	0075	SETI4	EXF		** SEARCH BACK ONE RECORD
7207	0013			TAPE3	
7210	0031			SBR	
7211	0264		UJP	T2	
7212	7171			SETI1	
7213	0000	FILE			** FILE NUMBER LOAD OR DUMP
7214	0000	NUMBER			** PROGRAM FILE COUNTER
7215	0000	NOEOF			** ZERO NO EOF AFTER DUMP.

FORMAT OF INPUT AND OUTPUT FOR PROGRAM MTLD.

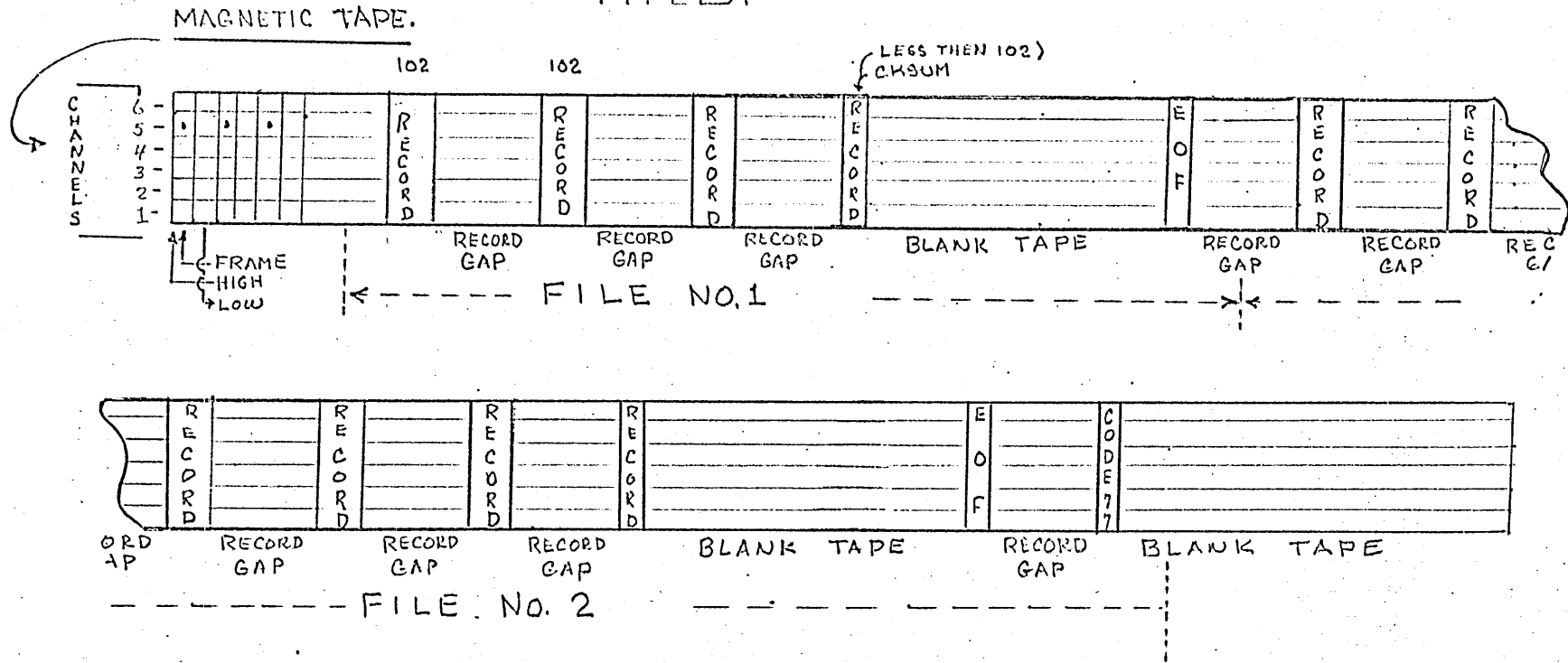

CHANNELS 1, 2, 3, AND 4 ARE PART OF AN 8-BIT WORD, CHANNEL 5, IS TO IDENTIFY HIGH ORDER OF THAT WORD.

THERE ARE 102 FRAMES PER RECORD. EXCEPT THE LAST RECORD OF THE FILE, ITS LESS THEN 102 FRAMES, THE CHECKSUM IS STORED IN THE LAST TWO FRAMES OF THAT RECORD. THEN BLANK TAPE BEFORE END OF FILE MARK.

FILE TWO, IS THE LAST FILE ON THIS TAPE. IT IS FOLLOWED BY BLANK TAPE, END OF FILE MARK AND CODE MARK (77) CODE MARK, ALLOWS PROGRAM "SET" TO IDENTIFY THE LAST FILE ON TAPE

MTLD

I. Function

A. General

Reads or writes in binary and low density on the normal channel, variable length records up to 102 characters. Each character consists of four bits stored in the low order position of the frame.

Checks for parity errors after each record, if the parity occurs five times for the same record, the program will halt and indicate that there was a parity error on the tape.

B. Detail

The routine writes a program or file from 8092B core to the Automatic Load and Dump Tape. The program or file is recorded on the tape as a file of 102 character records (note the last record can be less than 102 characters) the routine leaves about twelve inches of blank tape between files (that is between programs written on the tape). Each file is divided by an end of file mark, except the last file on the tape, it has an end of file mark and a code mark (octal 77). Code mark identifies the last file on the Automatic Load and Dump Tape. After dumping a program or file on the tape, MTLD will come to a halt and display its file number in the A register.

The routine reads a file or program from the Automatic Load and Dump Tape. After each record is read it checks for end of file mark, if file mark is present, the check sum which was built in the program LDFT is compared with the checksum on the tape and displayed in the A-register. If the A-register equals zero, the file was loaded correctly, if other than zero, the file was loaded incorrectly.

II. TAGS

TAG1	Not used.
TAG2	Programs execution tag.
TAG3	Used with the input/output of the records. Exit tag to the programs LPFT and DPTT3.

III. CONTROL WORDS

STOP	Input or output last word address.
AREA	Input or output first word address.
SIZE	Number of characters just inputted.
FLAG	Last record to be dumped for this file.
NOEOF	Control to write file mark and code mark.
CKSOM	Checksum of the file just inputted to the 8092B core.

IV. ENTRY POINT

MTLD	Entry point for the programs SET and DPTT.
------	--

MTLD1 Entry point for the program LPFT.

V.

EXITS
To LPFT
To DPTT3

PROGRAM NAME

MTLD

MAGNETIC TAPE LOAD and DUMP

ENTERING FROM SET, LPFT and DPTT

PROGRAM CONTROL WORDS	
STOP	INPUT/OUTPUT L.W.A.
AREA	INPUT/OUTPUT F.W.A.
SIZE	SIZE OF INPUT RECORD
FLAG	END OF OUTPUT DATA
NDOEF	CONTROL FOR WRITING FILE MARK
NUMBER	FILE NUMBER OF PROGRAM, JUST DUMPED
CKSUM	CHECK SUM OF PROGRAM, JUST LOADED

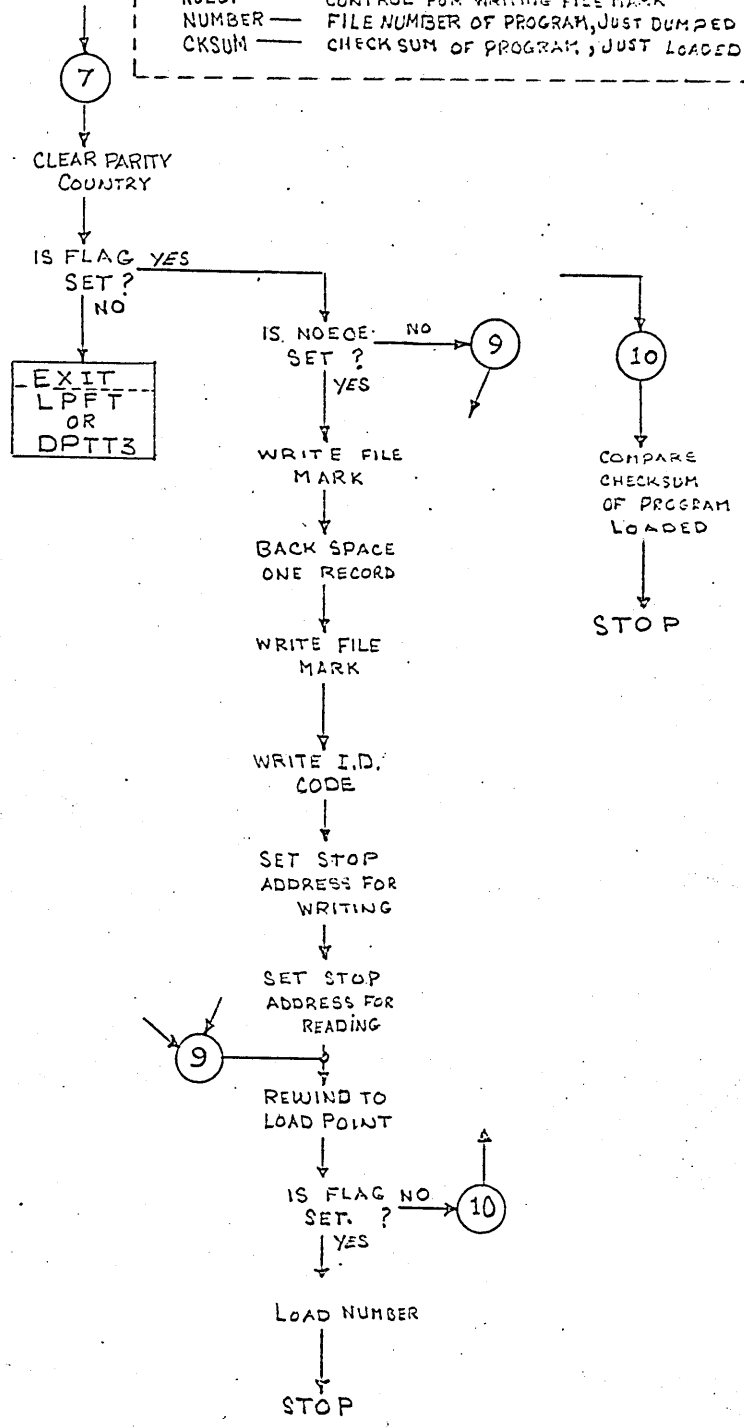
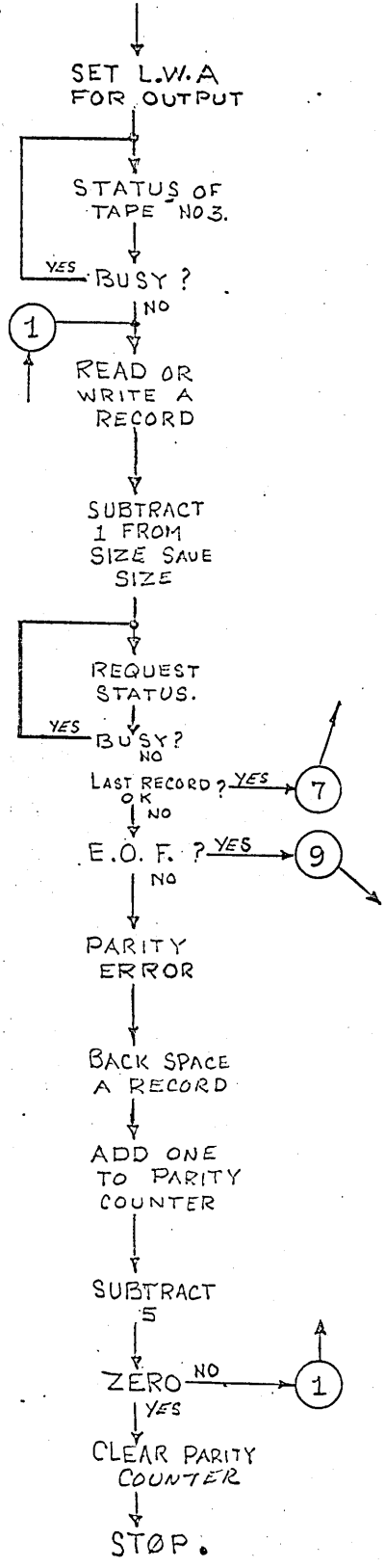

```

*****
*****
* PROGRAM NAME MTL D *
* *
* MAGNETIC TAPE LOAD AND DUMP *
* READS DATA OR WRITES DATA *
* TO 601 OR 603 USING 8093 *
* SYNCHRONIZER *
*****
*****

```

7216	0321	MTLD	LDM	T3	
7217	7666			STOP	
7220	0241		STM	T2	
7221	7235			MTLD4	
7222	0075	MTLD1	EXF		** STATUS OF TAPE UNIT
7223	0013			TAPE3	
7224	0000			RSO	
7225	0076		INA		
7226	0263		NJP	T2	
7227	7222			MTLD1	
7230	0075		EXF		
7231	0013			TAPE3	
7232	0000	MTLD2			** STORED CODE, WRITE OR READ
7233	0000	MTLD3			** STORED CODE, OUTPUT OR INPUT
7234	7670			AREA	
7235	7776	MTLD4	+106	AREA	
7236	0034		SBN		
7237	0001			I	
7240	0341		STM	T3	
7241	7662			SIZE	
7242	0075	MTLD5	EXF		**CHECK FOR E.O.F. AND PARITY
7243	0013			TAPE3	
7244	0000			RSO	
7245	0076		INA		
7246	0263		NJP	T2	
7247	7242			MTLD5	
7250	0010		LPN		
7251	0024			24	
7252	0260		ZJP	T2	
7253	7301			MTLD7	
7254	0034		SBN		
7255	0024			24	
7256	0260		ZJP	T2	
7257	7331			MTLD9	
7260	0075		EXF		
7261	0013			TAPE3	
7262	0031			SBR	
7263	0255		RAO	T2	

7264	7300			MTLD6	
7265	0034		SBN		
7266	0005			5	
7267	0261		NZP	T2	
7270	7222			MTLD1	
7271	0241		STM	T2	
7272	7300			MTLD6	
7273	0020		LDN		
7274	0022			22	
7275	0077		HLT		** STOP A = 22, PARITY ERROR IF YOU WISH TO TRY AGAIN, JUST CONTINUE FROM HERE
7276	0264		UJP	T2	
7277	7222			MTLD1	
7300	0000	MTLD6			** COUNTER FOR PARITY RETRIES
7301	0241	MTLD7	STM	T2	** TEST WRITING OR READING
7302	7300			MTLD6	
7303	0321		LDM	T3	
7304	7665			FLAG	
7305	0360		ZJP	T3	
7306	0000	MTLD8			** STORED ADDRESS FROM SET
7307	0221		LDM	T2	
7310	7215			NOEOF	
7311	0260		ZJP	T2	
7312	7331			MTLD9	
7313	0075		EXF		
7314	0013			TAPE3	
7315	0021			WFM	
7316	0075		EXF		
7317	0013			TAPE3	
7320	0031			SBR	
7321	0075		EXF		
7322	0013			TAPE3	
7323	0021			WFM	
7324	0075		EXF		
7325	0013			TAPE3	
7326	0020			WRT	
7327	0074		OTN		
7330	0077			77	
7331	0020	MTLD9	LDN		** RESET F. W. A. AND L. W. A.
7332	7772		+102	AREA	
7333	0341		STM	T3	
7334	7666			STOP	
7335	0030		ADN		
7336	0004			4	
7337	0241		STM	T2	
7340	7235			MTLD4	
7341	0075		EXF		

7342	0013			TAPE3	
7343	0034			RWL	
7344	0321		LDM	T3	
7345	7665			FLAG	
7346	0260		ZJP	T2	
7347	7353			MTLD10	
7350	0221		LDM	T2	** LOAD PROGRAM FILE NUMBER
7351	7214			NUMBER	
7352	0077		HLT		** STOP NEW PROGRAM ON TAPE A-REGISTER CONTAINS FILE NUMBER
7353	0321	MTLD10	LDM	T3	** CKSUM COMPARE, IF LOADED PROPERLY
7354	7661			CKSUM	
7355	0135		SBM	T1	
7356	0000			0	
7357	0135		SBM	T1	
7360	0000			0	
7361	0077		HLT		** STOP PROGRAM LOADED CKSUM IN A-REGISTER ZERO = LOADED O. K. NON-ZERO = LOADED BAD
7362	0321	DPTT	LDM	T3	
7363	7664			LAST	
7364	0034		SBN		
7365	0017			17	
7366	0363		NJP	T3	
7367	7400			DPTT2	
7370	0020		LDN		
7371	0377			377	
7372	0077		HLT		** STOP. A-REGISTER EQUALS 377, PROGRAM FOR DUMPING IS TOO LARGE. NO RECOVERY.
	7400	PRG		7400	

```

*****
*****
*      PROGRAM NAME  DPTT      *
*      *      *      *      *
*  BREAK UP 8BIT WORDS TO4BIT *
*  WORDS,STORE IN OUTPUT AREA *
*      FOR  DUMP      *
*      *      *      *      *
*****

```

7400	0020	DPTT2	LDN		** SET START ADDRESSES
7401	0000			0	
7402	0341		STM	T3	
7403	7411			DPTT4	
7404	0020		LDN		
7405	0270			270	

PROGRAM DPTT. FORMAT

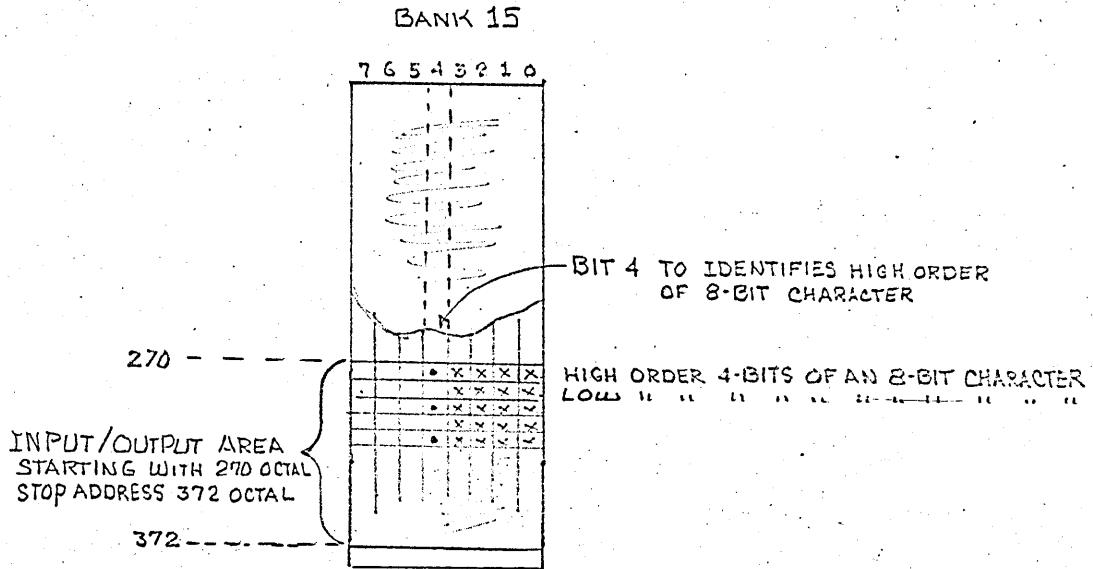
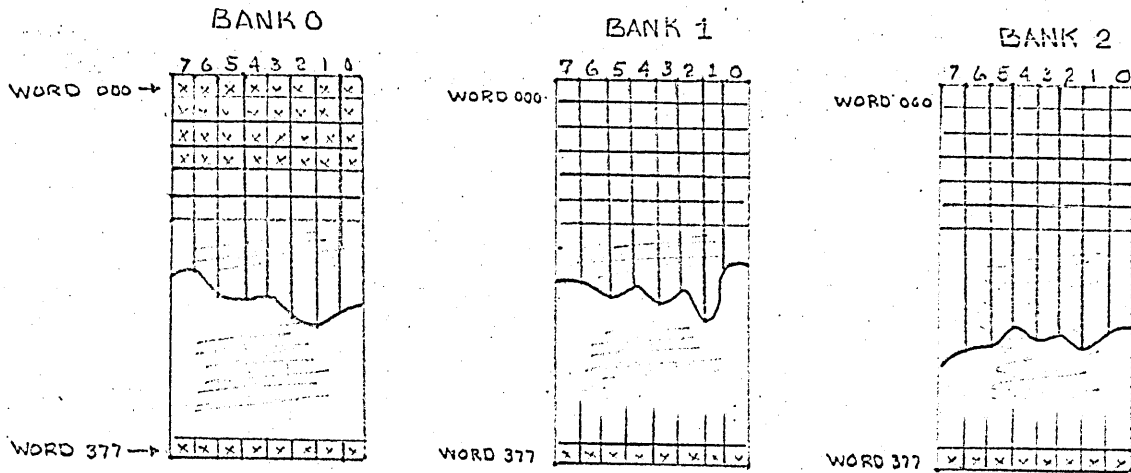

STARTING WITH THE WORD 000 OF BANK 0. TAKES THE 8-BITS DIVIDES THEM INTO TWO FOUR-BITWORDS, ADDS BIT 4 TO IDENTIFIE HIGH ORDER 4-BITS OF AN 8-BIT WORD. STORE THEM INTO BANK 15 STARTING WITH ADDRESS 270 OCTAL.

n nicholas

DPTT

I. Function

A. General

Takes an eight-bit word, checksums the eight bits then divides them into two four-bit words. The four bit words are stored into the INPUT/OUTPUT AREA so the program MTL D can output them onto the Automatic Load and Dump Tape.

B. Detail

The last word address for dumping the 8092B core, is address 377 of the last bank which was indicated for dumping. Starting address of the eight-bit words will always be word zero of bank zero. The eight bit words are checksummed, then divided into two four-bit words and identifies, the high order four bits of the eight-bit word by adding bit 4. Stores the high order word first, starting with the address of 270 octal of bank 15. The storage address is then incremented by one and the low order four-bits of the eight-bit word is stored. Both the store and start addresses are then incremented by one; then the processing of the eight-bit word will start again.

When the INPUT/OUTPUT AREA, (which is bank 15 starting with the word 270 octal as the first word address and 372 octal as the last word address) becomes filled, it releases control to program MTL D.

After the last eight bit word becomes processed the checksum word is then processed in the same manner, and sets a flag to indicate that this will be the last record for this file, then exits, to program MTL D.

Continuation

II. TAGS

- TAG1 Used in the loading of the eight-bit words.
- TAG2 Exit tag to the program MTL D.
- TAG3 Used for storing the four-bit words into the INPUT/OUTPUT AREA,
Program execution tag.

III. CONTROL WORDS

- LAST The last bank + one for dumping eight-bit words.
- 99 CKSUM Checksum of the eight bit words just dumped.
- BANK To indicate the crossing of a bank.
- STOP Last word address + one of the output area.
- AREA First word address of the output area.
- FLAG The last record to be dumped on this file.

IV. ENTRY POINTS

- DPTT Entry point for the program SET.
- DPTT3 Entry point for the program MTL D.

V. EXITS TO

MTL D

PROGRAM NAME

DPTT

DUMP PROGRAM TO TAPE

ENTERING FROM SET and MTL D

PROGRAM CONTROL WORDS

- LAST — LAST BANK +1 FOR DUMP
- CKSUM — CHECK SUM OF LAST PROGRAM DUMPED
- BANK — FLAG FOR CROSSING BANKS
- STOP — OUTPUT ADDRESS +1
- AREA — OUTPUT F.W.A
- FLAG — DUMP IS COMPLETED

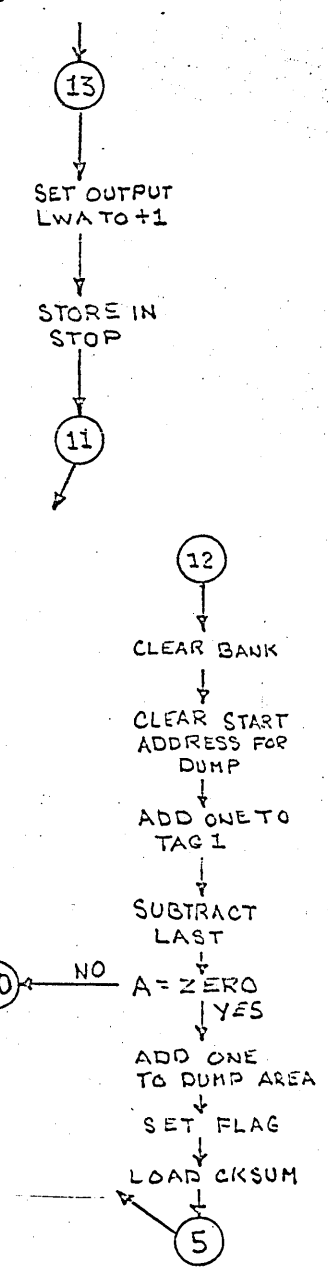
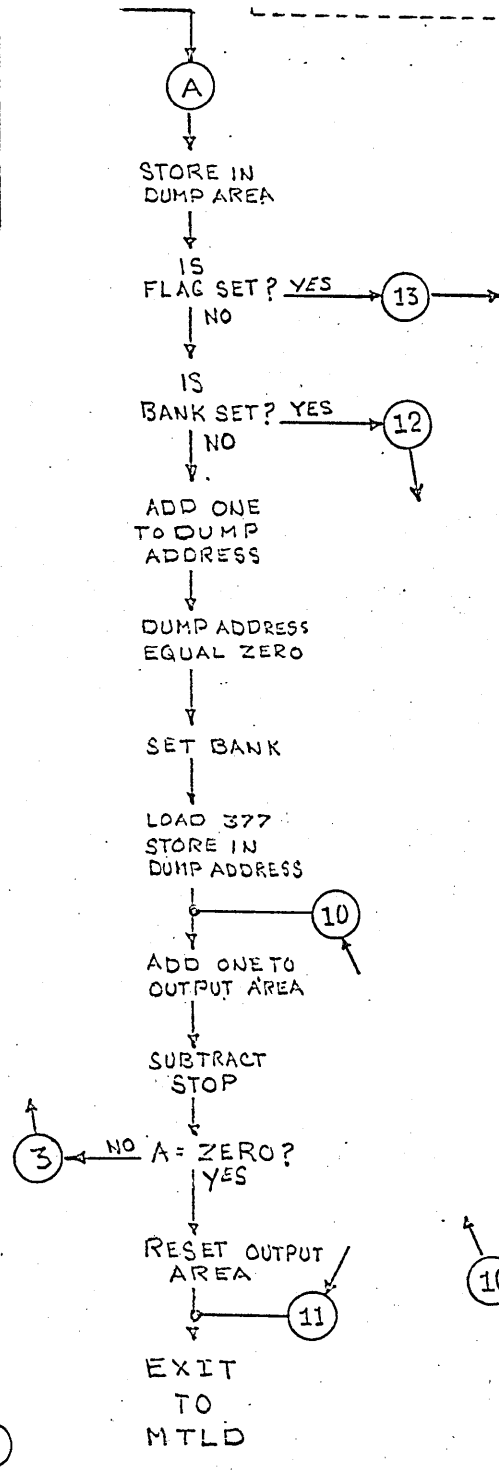
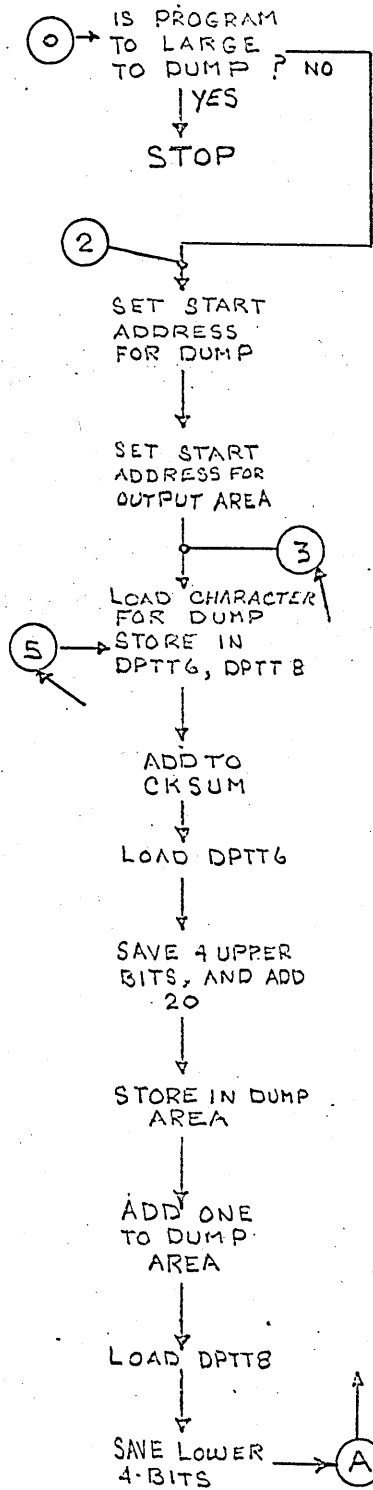

7406	0341		STM	T3	
7407	7433			DPTT7	
7410	0121	DPTT3	LDM	T1	** LOAD CHARACTER FOR DUMP
7411	0000	DPTT4		0	** DATA START ADDRESS FOR DUMP
7412	0341	DPTT5	STM	T3	** STORE DATA FORWARD
7413	7421			DPTT6	
7414	0341		STM	T3	
7415	7441			DPTT8	
7416	0351		RAM	T3	
7417	7661			CKSUM	
7420	0020		LDN		
7421	0000	DPTT6			** PROCESS HIGH ORDER OF WORD
7422	0010		LPN		
7423	0360			360	
7424	0001		SHA		
7425	0001		SHA		
7426	0001		SHA		
7427	0001		SHA		
7430	0030		ADN		
7431	0020			20	
7432	0341		STM	T3	
7433	0270	DPTT7		270	** START ADDRESS FOR DUMP
7434	0355		RAO	T3	
7435	7433			DPTT7	
7436	0341		STM	T3	
7437	7445			DPTT9	
7440	0020		LDN		
7441	0000	DPTT8			** PROCESS LOW ORDER OF WORD
7442	0010		LPN		
7443	0017			17	
7444	0341		STM	T3	
7445	0000	DPTT9		0	** STORE DATA IN OUTPUT AREA
7446	0321		LDM	T3	
7447	7665			FLAG	
7450	0361		NZP	T3	
7451	7531			DPTT13	
7452	0321		LDM	T3	
7453	7660			BANK	
7454	0361		NZP	T3	
7455	7504			DPTT12	
7456	0355		RAO	T3	
7457	7411			DPTT4	
7460	0361		NZP	T3	
7461	7470			DPTT10	
7462	0355		RAO	T3	
7463	7660			BANK	
7464	0020		LDN		
7465	0377			377	

7466	0341		STM	T3	
7467	7411			DPTT4	
7470	0355	DPTT10	RAO	T3	** INCREASE STORE AREA BY ONE
7471	7433			DPTT7	
7472	0335		SBM	T3	
7473	7666			STOP	
7474	0361		NZP	T3	
7475	7410			DPTT3	
7476	0020		LDN		
7477	7670			AREA	
7500	0341		STM	T3	
7501	7433			DPTT7	
7502	0264	DPTT11	UJP	T2	** EXIT TO PROGRAM MILD
7503	7216			MTLD	
7504	0003	DPTT12	TTA		** START OF NEXT BANK
7505	0341		STM	T3	
7506	7660			BANK	BANKS
7507	0341		STM	T3	
7510	7411			DPTT4	
7511	0103		TTA	T1	
7512	0030		ADN		
7513	0001			I	
7514	0102		ATT	T1	
7515	0335		SBM	T3	
7516	7664			LAST	
7517	0361		NZP	T3	
7520	7470			DPTT10	
7521	0355		RAO	T3	
7522	7433			DPTT7	
7523	0355		RAO	T3	
7524	7665			FLAG	
7525	0321		LDM	T3	
7526	7661			CKSUM	
7527	0364		UJP	T3	
7530	7412			DPTT5	
7531	0020	DPTT13	LDN		** SET SIZE FOR OUTPUT
7532	0001			I	
7533	0351		RAM	T3	
7534	7433			DPTT7	
7535	0341		STM	T3	
7536	7666			STOP	
7537	0364		UJP	T3	
7540	7502			DPTT11	

FORMAT FOR PROGRAM

LDFT

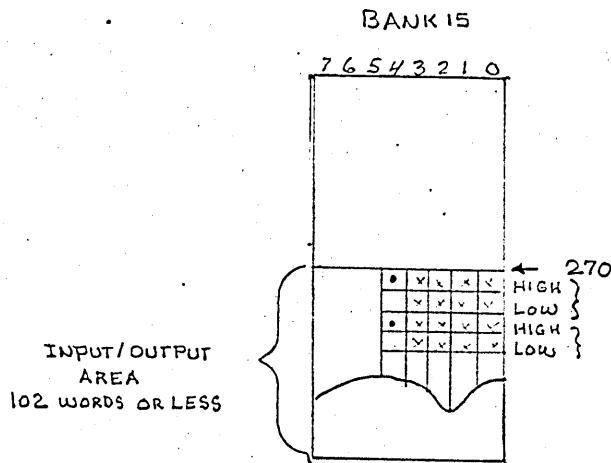

INPUT/OUTPUT AREA BITS 5, 6 AND 7 NOT USED. BIT 4 IDENTIFIES HIGH ORDER BITS.
BITS 3, 2, 1 AND 0 ARE THE BITS TO BUILD AN EIGHT BIT WORD.

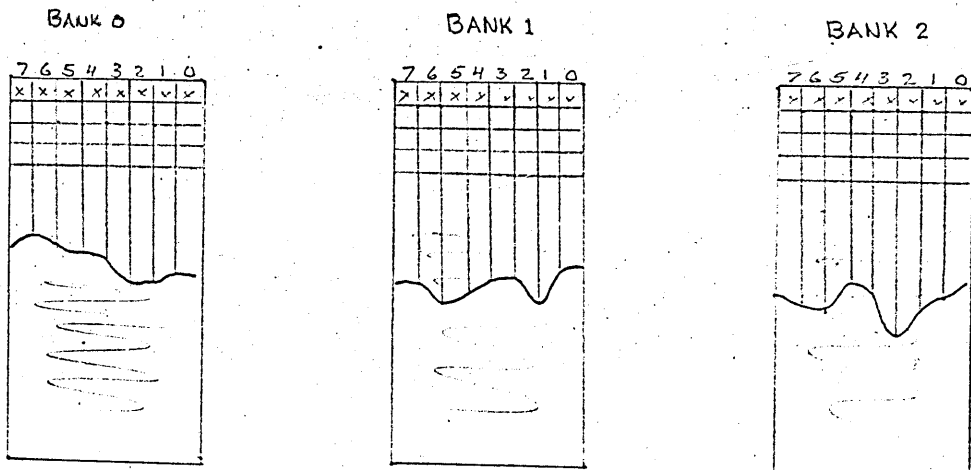

COMBINES THE GROUPS, HIGH AND THE LOW ORDERS OF BITS 3, 2, 1 AND 0 INTO AN EIGHT BIT WORD. BITS 3, 2, 1 AND 0 OF THE HIGH ORDER ARE SHIFTED TO BITS 7, 6, 5, AND 4 OF THE 8-BIT WORD, THEN BITS 3, 2, 1 AND 0 OF THE LOW ORDER ARE COMBINED WITH THE 8-BIT WORD, AND STORED INTO THE 8092B CORE STARTING WITH WORD ZERO OF BANK ZERO. IT WILL CONTINUE TO COMBINE THE HIGH AND THE LOW, TAKE THE CHECKSUM AND STORES THEM UNTIL THE FILE IS COMPLETED.

LDFT

I. Function

A. General

Takes the four-bit input words and assembles them into eight-bit words, checksums the eight-bit words stores them in bank zero starting with word zero. The storage address is incremented for the next eight-bit character. The process is repeated until the program MTL D detects the end of file from the Automatic Load and Dump Tape.

B. Detail

The input words (which are inputted by MTL D) are stored in bank 15 starting with address 270. They are four bit words with identification of the four high order bits for each eight bit word. The high order bits are combined with the corresponding low order bits, in assembling an eight-bit Teleprogrammer word. This eight-bit word is checksummed and then stored into the 8092B core starting with word zero of bank zero. The storage address is then incremented by one. The process will continue until the end of file mark is detected by the program MTL D.

II. TAGS used

TAG1 Used for storing of the eight bit words.
TAG2 Exit tag to the program MTL D1.
TAG3 Used with the input of the four bit words, LDFT execution tag.

III. CONTROL WORDS

HOLD Temporary storage to build the eight bit word.
CKSUM The adding of the bits in an eight-bit word before storing.

BANK Crossing of the banks before storing next eight-bit word.
SIZE The number of characters of the last input record.
AREA The starting address of the input record.

IV. ENTRY POINTS

LDFT Entry point for the program MTL D.

V. EXITS

To MTL D1

PROGRAM NAME

LPFT

LOAD PROGRAM FROM TAPE

ENTERING FROM MTL D

PROGRAM CONTROL WORDS.

HOLD	TEMP STORE WORD
CKSUM	CHECKSUM OF PROGRAM LOADED
BANK	FLAG FOR CROSSING BANKS
SIZE	INPUT OF CHARACTER INPUTED
SIZE1	LAST INPUT CHARACTER COUNT.
AREA	INPUT F.W.A.

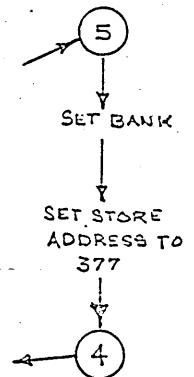
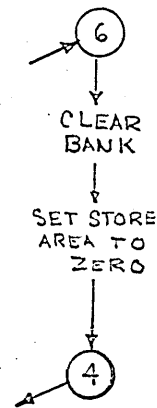
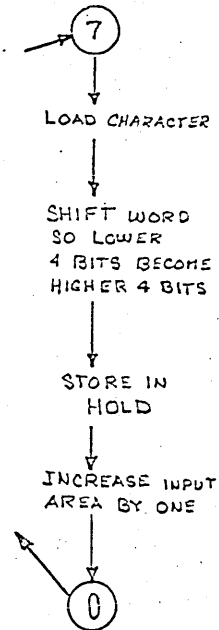
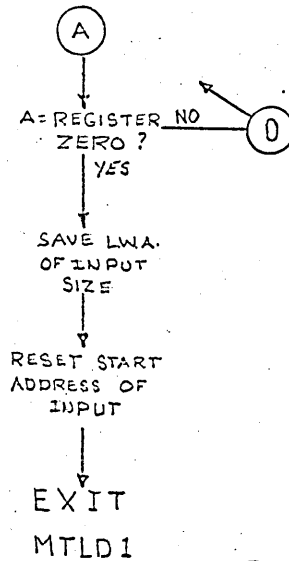
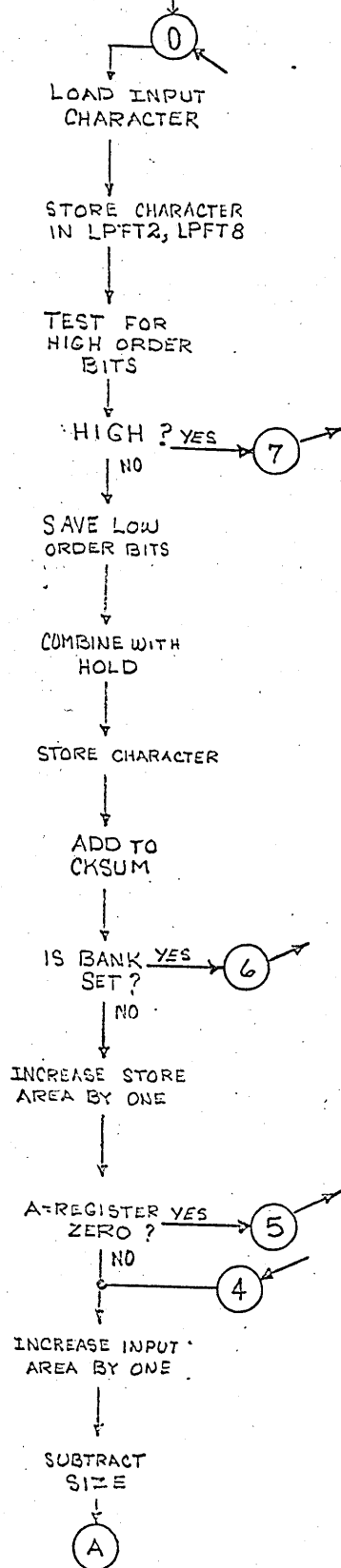

```

*****
*****
*          PROGRAM NAME  LPFT          *
*          *
* BREAKUP TWO FOUR BIT WORDS *
* TO MAKE UP ONE 8-BIT WORD *
* COMING IN FROM MAGNETIC *
*          TAPE          *
*****
*****

```

7541	0321	LPFT	LDM	T3	
7542	0270	LPFT1		270	** FWA OF INPUT DATA
7543	0341		STM	T3	
7544	7562			LPFT2	
7545	0341		STM	T3	
7546	7641			LPFT8	
7547	0034		SBN		
7550	0077			77	
7551	0360		ZJP	T3	
7552	7656			LPFT9	
7553	0030		ADN		
7554	0077			77	
7555	0010		LPN		
7556	0020			20	
7557	0361		NZP	T3	
7560	7640			LPFT7	
7561	0020		LDN		
7562	0000	LPFT2			** LOWER 4-BITS OF CHARACTER
7563	0315		LSM	T3	
7564	7657			HOLD	
7565	0141		STM	T1	
7566	0000	LPFT3		0	** STORE ADDRESS FOR DATA
7567	0351		RAM	T3	
7570	7661			CKSUM	
7571	0321		LDM	T3	
7572	7660			BANK	
7573	0361		NZP	T3	
7574	7625			LPFT6	
7575	0355		RAO	T3	
7576	7566			LPFT3	
7577	0360		ZJP	T3	
7600	7615			LPFT5	
7601	0355	LPFT4	RAO	T3	** INCREASE FWA BY ONE
7602	7542			LPFT1	
7603	0335		SBM	T3	
7604	7662			SIZE	
7605	0361		NZP	T3	
7606	7541			LPFT	

7607	0020		LDN		
7610	7670			AREA	
7611	0341		STM	T3	
7612	7542			LPFT1	
7613	0264		UJP	T2	** GO READ NEXT RECORD
7614	7222			MTLD1	
7615	0355	LPFT5	RAO	T3	** SET SWITCH, CROSSING BANK
7616	7660			BANK	
7617	0020		LDN		
7620	0377			377	
7621	0341		STM	T3	
7622	7566			LPFT3	
7623	0364		UJP	T3	
7624	7601			LPFT4	
7625	0003	LPFT6	TTA		** SET ADDRESS FOR NEXT BANK
7626	0341		STM	T3	FOR STORING CHARACTERS
7627	7660			BANK	
7630	0341		STM	T3	
7631	7566			LPFT3	
7632	0103		TTA	T1	
7633	0030		ADN		
7634	0001			I	
7635	0102		ATT	T1	
7636	0364		UJP	T3	
7637	7601			LPFT4	
7640	0020	LPFT7	LDN		** UPPER 4-BITS OF CHARACTER
7641	0000	LPFT8			** PRESTORED CHARACTER
7642	0010		LPN		
7643	0017			17	
7644	0001		SHA		
7645	0001		SHA		
7646	0001		SHA		
7647	0001		SHA		
7650	0341		STM	T3	
7651	7657			HOLD	
7652	0355		RAO	T3	
7653	7542			LPFT1	
7654	0364		UJP	T3	** GET NEXT CHARACTER FOR WORD
7655	7541			LPFT	
7656	0077	LPFT9	HLT		** JOB FILE CALLED FOR NOT ON (ALD) TAPE

7657	0000	HOLD			** TEMP STORAGE FOR CHARACTER
7660	0000	BANK			** CROSSING OF BANK TEST
7661	0000	CKSUM			** CHECKSUM FOR CHARACTERS
7662	0000	SIZE			** SIZE OF INPUT RECORD NEW
7663	0000	SIZE1			** SIZE OF INPUT RECORD OLD
7664	0000	LAST			** LAST BANK TAG FOR DUMP
7665	0000	FLAG			** END OF OUTPUT DATA
7666	7772	STOP	+102	AREA	** INPUT -- OUTPUT = STOP ADDRESS
	7670		PRG	7670	
7670	0000	AREA			** AREA STARTING I/O FWA
	0373	OUTT3	EQU	373	** OUTPUT SELECT CODE TAG 3
	0372	INNT3	EQU	372	** INPUT SELECT CODE TAG 3