

**CONTROL DATA  
8050  
INFORMATION  
CONTROL SYSTEM**



## CHAPTER ONE

### CONTROL DATA 8050 INFORMATION CONTROL SYSTEM

SYSTEM OPERATION	1-2
POLLING	1-2
Non-Operating Stations	1-2
Transmitter Start Codes	1-3
Control of Polling Sequences	1-3
MONITORING PROCEDURE	1-4
Incoming Messages	1-4
Message Codes	1-4
Character Transmittal	1-4
Lost Character	1-5
Input Inactive	1-5
Open Line	1-5
MESSAGE SWITCHING	1-7
Incoming Message Format	1-7
Start of Tape	1-7
Call Directing Codes	1-7
End of Header; Start of Text	1-7
Message	1-7
End of Message	1-7
End of Transmission	1-7
Switching	1-8
Routing	1-8
Switching to Higher Speed Lines	1-8
Switching to Lower Speed Lines	1-9
Switching to Priority	1-9
Queueing Limits	1-9
Outgoing Messages	1-10
Transmission	1-10
Trunk Hunting	1-10
Failure to Access Drum	1-10
MESSAGE ACCOUNTING FUNCTIONS	1-12
Incoming Messages	1-12
Outgoing Messages	1-12
Character Count	1-12
COMMUNICATIONS WITH OTHER SYSTEMS	1-13

CHAPTER TWO  
8404-A OPERATOR'S CONSOLE

OPERATIONAL SWITCHES AND INDICATORS	2-3
STATUS SWITCHES	2-3
Start	2-3
Stop	2-3
Enter	2-4
COMPUTER MONITOR INDICATORS	2-4
Monitor Failure	2-4
Transfer to Monitor	2-4
Transfer to Switcher	2-4
Input/Output Failure	2-4
Interrupt Clock Failure	2-5
PERIPHERAL MONITOR INDICATORS	2-5
Normal Channel Alarm	2-5
Buffer Channel Alarm	2-5
169 Channel Alarm	2-5
OPERATOR ALARM SWITCHES	2-5
Alarm Acknowledge	2-5
Alarm Silence	2-6
TIME OF DAY CLOCK	2-6
Digital Display	2-6
POWER SWITCHES	2-6
System Key Lock	2-6
Power ON/OFF	2-6
RESTART LAMPS	2-6
Service Message	2-7
Lines Inactive	2-7
Transfer Complete	2-7
ALARM CONDITION LAMPS	2-8
No Poll Response	2-8
Format Error	2-9
Lost Character	2-9
Inactive Line	2-9
Open Line	2-10
Queue Limit Exceeded	2-10
Queue Failure	2-10
DP Failure	2-10
DQ Failure	2-10
Printer Failure	2-11
Buffer Alarm	2-11
Spare Alarm	2-11

ROTARY SELECTOR SWITCHES	2-11
Function Switches	2-11
Line Number Switches	2-12
Station Address Switches	2-12
Alternate Station Address Switches	2-12
Polling Delay Switch	2-12
Polling Interval Switch	2-13
Polling Position Switch	2-13
Transmitter Start Code Switch	2-13
Queue Limit Switches	2-13
OPERATION OF SELECT SWITCHES	2-14
Initiate Willful Intercept	2-14
Terminal Willful Intercept	2-14
Queue Dump	2-15
Polling Sequence General	2-15
Change Polling Delay	2-15
Change Polling Interval	2-15
Terminate Polling Station	2-16
Initiate Polling Station	2-16
Initiate Alternate Route	2-16
Terminate Alternate Route	2-16A
Queue Limit QT1	2-16A
Queue Limit QT2	2-16A
Character Count	2-17
End of Message	2-17
Emergency Stop	2-17
Initiate Busy	2-17
Terminate Busy	2-18
OPERATOR INFORMATION RO PRINT-OUTS	2-19
SWITCHER RO PRINT-OUTS	2-19
Operator Initiated Commands	2-19
Switcher Initiated Commands	2-21
MONITOR RO PRINT-OUTS	2-23
OPERATION OF CONSOLE	2-24
MORNING START-UP AND EVENING SHUT-DOWN PROCEDURES	2-24
Start-up	2-24
Shut-down	2-24
System Status During Inoperative Hours	2-25
System Status at Start-up	2-25

OPERATOR OPTIONS	2-25
Functions the Operator May Perform	2-25
DESCRIPTION OF FUNCTIONS	2-28
RESTART	2-28
MONITOR FUNCTIONS	2-28
INTERCEPT	2-29
Normal	2-29
Abnormal	2-29
TOP LINE RECORDING	2-29
Normal Top Line Printing	2-29
Abnormal Top Line Printing	2-30
FUNCTION SELECT CODES AND SWITCH SETTINGS	2-31
FUNCTION CODE 5600 (etc.)	2-31
PERIPHERAL CHANNEL MONITOR (PCM)	2-39

### CHAPTER THREE

INTRODUCTION	3-1
8155 Multiplexer Cabinet	
8165 Master Multiplexer (MMUX)	
8166 Input Slave Multiplexer (IMUX)	
8167 Output Slave Multiplexer (OMUX)	
8508 Low-Speed Input Unit (LSIU)	
8509 Low-Speed Output Unit (LSOU)	
8901-B Time of Day Clock	
8909 Test Board Unit	
8910 Dual Computer Transfer Unit	
8912 Reset Timer	

Glossary



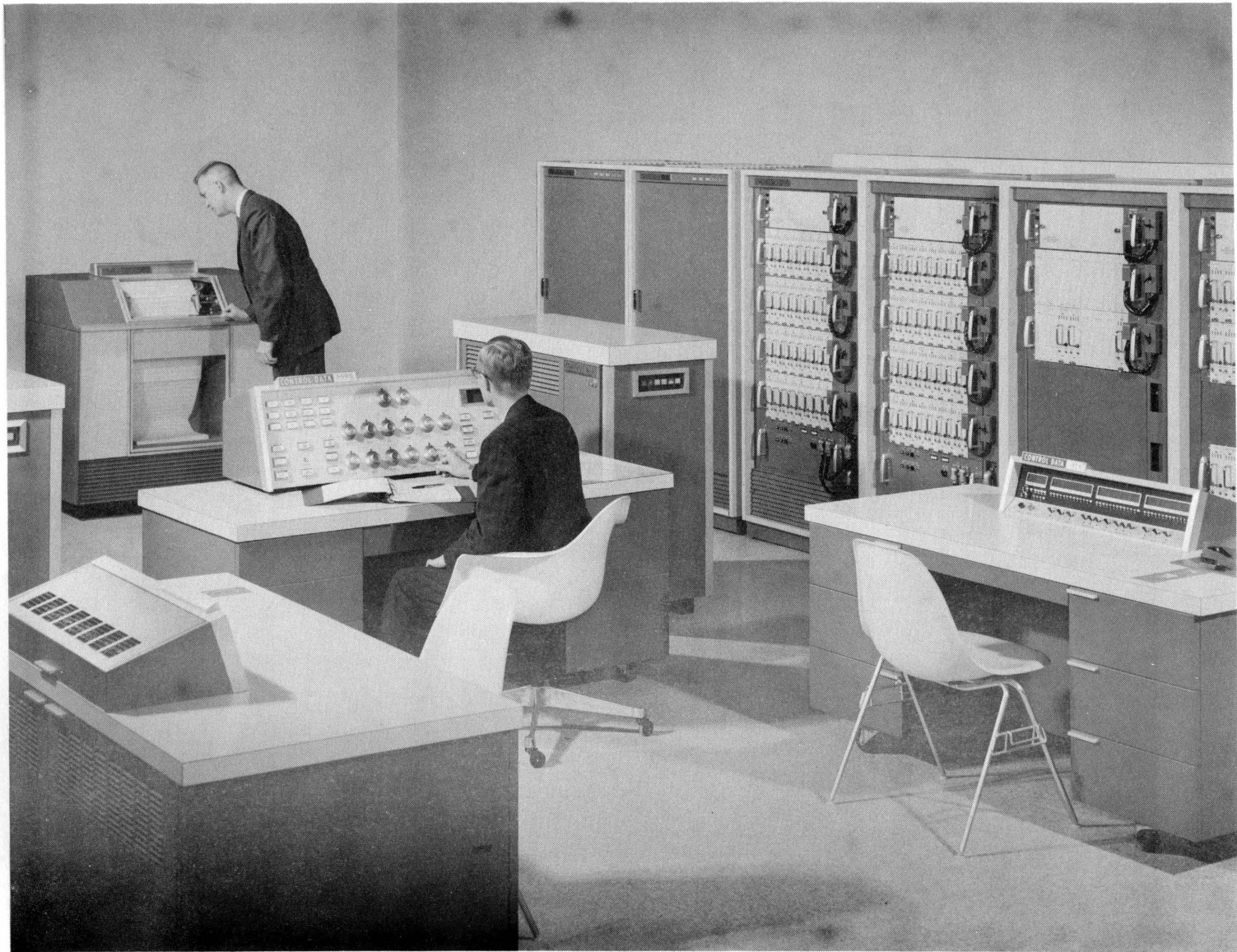

TYPICAL CONTROL DATA 8050 INFORMATION CONTROL SYSTEM



INTRODUCTION  
THE CONTROL DATA 8050  
INFORMATION CONTROL SYSTEM

The CONTROL DATA\* 8050 Information Control System consists of a group of units which handle information of varying codes and speeds and for the proper collection of this data and dissemination of it to remote points. One of the primary applications of the 8050 system is the replacement of conventional teletypewriter switching systems and manual torn-tape switching offices. The 8050 system is far superior in speed and efficiency. It is especially suited for use in heavy services involving several long-distance lines.

The 8050 system has a wide variety of applications; for example --

- Coordination of inventories, price quotations, and sales orders from several warehouses and offices throughout the country.
- Coordination of a company's stock and bond transactions at a central stock exchange from several branch offices in other cities.
- Many other types of coordination of decentralized systems where data can be sent to a central control office and quickly processed or manipulated into proper functional channels.

The 8050 System uses proven CONTROL DATA central processors and peripheral equipment. The equipment is built in standard modules which can be arranged and connected to fit a variety of applications at lowest possible cost. Even standard general-purpose computers are used as switches and monitors. Functions peculiar to the message circuits are built into communications devices external to the computers.

---

\* Registered Trademark

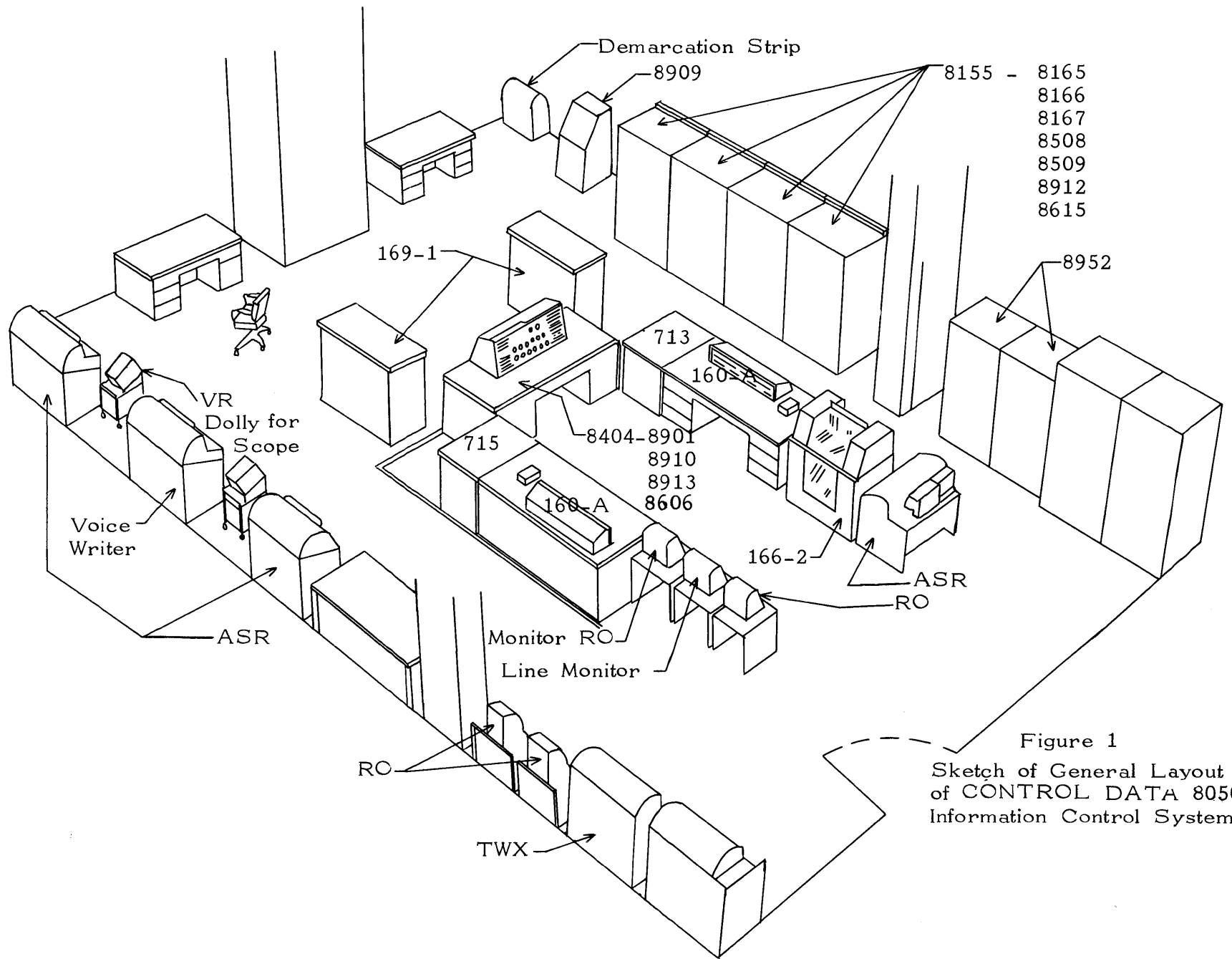

Figure 1  
 Sketch of General Layout  
 of CONTROL DATA 8050  
 Information Control System

LIST OF CONTROL DATA EQUIPMENT WHICH MAY BE USED  
IN A TYPICAL 8050 INFORMATION CONTROL SYSTEM

CDC  
Model No.    Description

8050-System Equipment

8155		Multiplexer (including a combination of the following units:)
8461		Cabinet
8165		Master Multiplexer (MMUX)
8166		Input Slave Multiplexer (IMUX)
8167		Output Slave Multiplexer (OMUX)
8508	} or }	Low-Speed Input Unit (LSIU) 5-Bit
8509		Low-Speed Output Unit (LSOU) 5-Bit
8518		Low-Speed Input Unit (LSIU) 8-Bit
8519		Low-Speed Output Unit (LSOU) 8-Bit
8912		Reset Timer
8615-B		Dual Power Supply
8606		Single Power Supply

8404	System Console (including the following units:)
8901-B	Time-of-Day Clock
8910	Dual Computer-Transfer Unit
8606-A	Logic Power Supply

713	Data Exchange Unit (DXU)
715	Data Exchange Unit (DXU)

8909	Test Board Unit
8601	Logic Power Supply

Computers and Peripheral Equipment

160-A	Computer (Switcher)
169-1	Auxiliary Memory Unit
166-2	Buffered Line Printer
8952	Memory System

Note: This is a typical arrangement. Many other peripheral equipments are compatible with the 8050 system.

TELEGRAPH LINES (CHANNELS) TO WAY-STATIONS

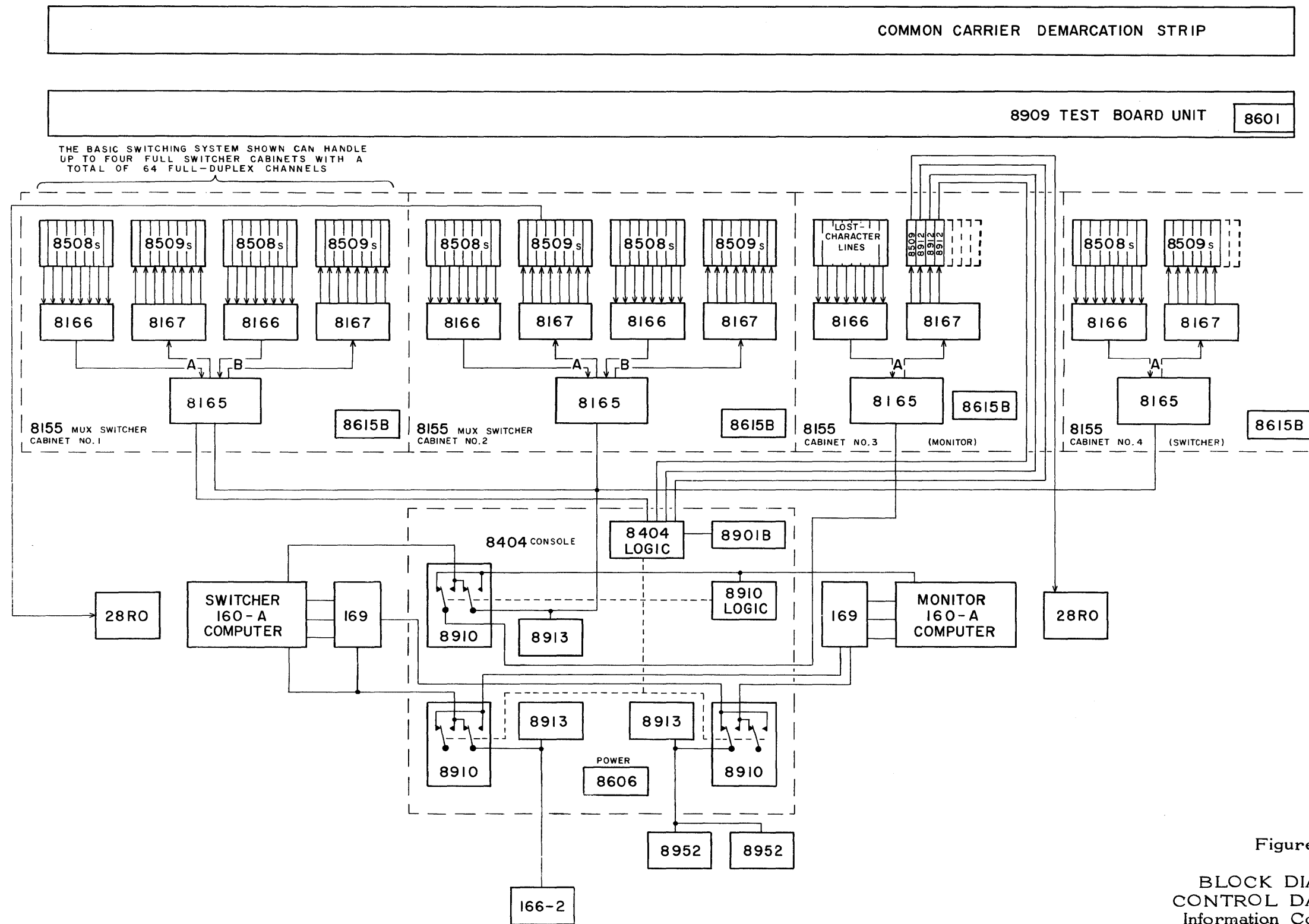

NOTE:  
ALL 8910'S SHOWN IN ENERGIZED POSITION  
WITH SWITCHER IN CONTROL.

Figure 2

BLOCK DIAGRAM  
CONTROL DATA 8050  
Information Control System

CHAPTER ONE  
OPERATION OF THE  
8050 INFORMATION CONTROL SYSTEM

This chapter introduces a number of the basic Functions of the Information Control System. Polling, monitoring, message switching, and message accounting are covered.

Functions dealing basically with the System such as, starting, restart, intercept, operator's options, etc. are described in Chapter Two (8404 System Console).

## SYSTEM OPERATION

### POLLING

Polling is the interrogating by the computer of all remote transmitting stations in sequence to determine whether they have any messages to transmit. Polling is required to initiate the transmission of any message on a multistation line. Remote stations are polled when the incoming line for that channel is idle. To initiate a polling sequence a character pattern --

Blank Character  
700 MS  $\pm$  15% delay  
Space Character

is transmitted to lock out all ROs on that line and activate the Transmitter Start Code (TSC) recognition circuits. Then polling commences. Polling is followed by another character pattern,

LTRS LTRS

which restores the outgoing line to its status prior to polling. If an outgoing line is active when polling is required, the outgoing message is interrupted for the duration of the polling sequence.

### Non-Operating Stations

A station is not polled during its non-scheduled hours or when its line to the switching center is inoperative.

---

\* See Teletypewriter Code Chart in back of 8508 Section

### Transmitter Start Code

Each station on a multistation line has its own unique Transmitter Start Code (TSC). If there is no message in the Transmitter Distributor (TD) a station responds to its TSC by sending a "no message" character (H) to the switching center. If a station has a message ready for transmission, the station begins transmission upon receipt of its TSC. The time between the end of a message and the next polling is called polling delay. This delay can be modified by the operator. If all stations send a "no message" character response, the line is polled again after a polling interval. This interval can be modified by the operator.

### Control of Polling Sequences

All TSCs and polling sequences are controlled by a table. Polling sequences can be changed by the operator. If a station does not respond to its TSC within an average period of 9 seconds, the station is considered inoperative and the system operator notified of this condition. The station is polled and the system operator notified of the condition until the station is removed from the polling sequence. The system operator must force the polling sequence to resume polling of the station if he has initiated a polling termination for that station.

## MONITORING PROCEDURE

### Incoming Messages

All incoming messages are monitored for incorrect start codes, headers, and stop codes. The text is monitored for repetitious characters and specified message format errors in the case of fixed format messages. Invalid headers, and fixed format errors are alarmed and indicated, and the associated messages are directed to the intercepting system. If repetitious characters are detected by the switcher during receipt of a message, an alarm is sounded and the condition reported on RO print-out.

### Message Codes

If the system receives a start-of-message code before the previous message has been terminated, the system automatically terminates the message with an indication code and an "End of Message" code. The "End of Message" code terminates the message and clears the system to receive the next message header.

### Character Transmittal

Characters arrive at the center in 7.42-unit start-stop teletypewriter code. The start and stop pulses are removed from the characters as they enter the 8508 intermediate register serially-by-bit. When an entire character is assembled in the 8508 intermediate register, it is transferred to the output holding register of the 8508 for withdrawal by the switcher. At this time a Character Ready signal is generated. The Character Ready signal is cleared after the character is acquired by the switcher. The characters are then stored sequentially in a core storage area with appropriate notation for future retrieval and transmission.



Lost Character - If a character is placed in the holding register of the 8508 LSIU and not acquired by the switcher before receipt of the next input character two events occur:

1. The new character is moved to the output holding register destroying the previous character, and
2. a signal line is energized denoting CHARACTER LOST. This signal line is encoded by the multiplexer and entered in the status bits of the next computer word for that channel. The computer responds by substituting a space character for the lost character. An alarm is sounded and the condition reported on RO print-out. The message is transmitting to its destination except for inquiry messages for DQ which are sent to the intercept system.

Input Inactive - If the character input should fail to be continuous for any reason the receiving 8508 detects this within five seconds. A signal line is energized denoting INACTIVE CHANNEL. This signal is encoded by the Multiplexer and entered in the status bits of the next computer input word for that channel. An alarm is sounded and the condition reported. After a time (initially 42 seconds) determined by a constant in the program, the switcher generates

CR LF LTRS FIGS N LTRS LTRS EOM FIGS H LTRS

to clear the outgoing line and send the message to its destination(s).

Open Line - If a circuit failure occurs that results in no line current or if a remote station activates a BREAK key, Low-Speed Input Unit detects the absence of marking current during one character period and energizes a signal line to the multiplexer. This signal is encoded by the multiplexer as a status bit to the computer for that Input Unit channel. An alarm is sounded and the condition reported. If during the receipt of a message the line opens, then after a time

(initially 6 seconds) determined by a constant in the program, the switcher generates

CR LF LTRS FIGS N LTRS LTRS EOM FIGS H LTRS

to clear the outgoing line and send the message to its destination.

## MESSAGE SWITCHING

### Incoming Message Format

All incoming messages have the following format:

#### Start of Tape

LTRS LTRS LTRS LTRS FIGS H LTRS

At least three LTRS characters must precede FIGS at the beginning of all tapes.

Call Directing Codes The message for a single address message is:

LK LTRS (e.g. Milwaukee)

The message header for a multi-address message is:

BC LTRS PA LTRS LK LTRS (e.g. Philadelphia and Milwaukee)

Before cut-over multi-address messages always begin with BC LTRS (Broadcast) which is ignored by the switcher. After cut-over BC LTRS no longer are ignored but handled like an invalid Call Directing Code (CDC). Therefore, a way station procedure affecting the elimination of BC as a broadcast code is required.

End of Header; Start of Text -

CR LF LTRS

Message - (~~Text~~ of Message)

End of Message - The following code appended to each message:

FIGS H LTRS

End of Transmission - This ending appended to the end of a single message of a multi-message tape:

H LTRS and LTRS out.

No intervening characters are permitted between End Of Message and End Of Transmission.

## Switching

Routing The incoming message is scanned during the header reception for destination codes. When a CDC is received the message is switched to the outgoing line and all characters after the receiving stations' CDCs are received at the destination. When an invalid CDC is received, the message and the complete header are sent to the intercept system.

Single-address messages to multi-station lines do not have their receiving CDC printed. Single address messages to single-station lines print their receiving station CDC. For multiple-address messages to single-station lines, the complete header is printed.

Switching to Higher Speed Lines If an incoming message is to be switched to a line of higher speed the following apply:

1. The outgoing message always has the faster speed independent of the incoming character rate. The outgoing line must wait for the incoming line to "catch up" between blocks of data.
2. The incoming message enters a storage block character-by-character until the block is filled at the incoming character rate. The entire blockful of information is transferred to queue storage area. Meanwhile the incoming message starts to refill the first storage block.
3. When the outgoing line is available it sends the first block of data at the faster outgoing rate. Then it waits for the slower incoming line to fill the next block of information.
4. The net result is that the outgoing message travels at a faster rate than the incoming message in the form of send--pause--send--pause, etc. until the entire message is sent.

Switching to Lower Speed Lines If an incoming line is to be switched to an outgoing line of lower speed, the outgoing character rate will be that of the outgoing line and a character queue will exist during transmission.

Switching Priority If the outgoing line is available, the message is switched immediately after end of header. If the outgoing line is busy, the message is sent to queue until the outgoing line is available. Selection of a message to transmit to a given line from several queued messages is based on chronological priority by line. DQ messages received from the RCA 301 system are assigned an outbound priority. This enables them to be transmitted immediately on termination of the outbound message in progress for a given line.

Queueing Limits The operator, from the system console, can specify the maximum allowable time a message can be held in queue storage awaiting its outgoing line. If this time is exceeded for any outgoing message, the message will automatically be directed to intercept if the outgoing queue list for intercept is less than a program constant. (If the operator sets the allowable time too low, the system will be adversely affected.) If the amount of queue storage in use exceeds an amount specified by a constant in the program, all polling will be terminated until the amount of queue storage being used falls below a second program constant. The above condition sounds an alarm and is indicated. This insures that messages are not lost in the event a large number of outgoing lines are out of service.

### Outgoing Messages

Outgoing messages have the same format as incoming messages except for the changes noted under Routing. On a multistation line stations begin printing with the first character following their CDC. In some cases this is the first character of the message; in other cases it is the remaining CDCs of a multi-address message.

Transmission To transmit an outgoing character the outgoing channel is selected and the character is transmitted to the 8509, Low-Speed Output Unit. Characters leave the 8509 in 7.5 unit start-stop teletypewriter code. The start and stop pulses are added to the characters as they leave the intermediate register of 8509 serially-by-bit.

Trunk Hunting If the CDC refers to a destination that has more than one connecting trunk, a subroutine scans the status of all connecting trunks to the destination in a sequential manner and switches the message via the next available trunk before allowing the message to queue. Thus all messages to those destinations which have more than one connecting trunk are switched immediately as long as any trunk to the destination is free. If no trunk to the destination is available the message is queued and switched via the first available trunk.

Failure to Access Drum If a drum in the queue memory system cannot be accessed, one of two possible conditions exists

1. If the initial half line of a message cannot be retrieved, the condition is alarmed and the operator notified by RO print-out. The system processes the next message in sequence and the preceding message will be deferred until the drum can be addressed.

2. A continuing half-line of a message in progress cannot be retrieved. This condition is alarmed and the operator notified by RO print-out. The message is terminated, and the next message in sequence processed. The message which was terminated will be resent when the drum can be accessed.

## MESSAGE ACCOUNTING FUNCTIONS

### Incoming Messages

A character count is kept for each station originating messages. The character count includes all teletypewriter characters and non-printing functions.

### Outgoing Messages

A character count is kept for each outgoing line or trunk. The character count includes all teletypewriter characters and non-printing functions.

### Character Count

The character count is accumulated throughout the day. The accumulated character count for each originating station and for each outgoing line or trunk is available to the system operator. When a character count is requested by the operator, the setting of all character counters (system memory locations) is reported to the operator. Any request for a character count clears all counters to zero, and may be initiated at any time of the day. The operator should request the character counts at the end of each day of operation.

## COMMUNICATIONS WITH OTHER SYSTEMS

Special Data Exchange Units are available which allow direct communication through interface with other systems. For example the 715 Data Exchange Unit permits communication with the RCA 501 Data Processing System. Also the 713 Data Exchange Unit permits communication with the RCA 301 Data Processing System.

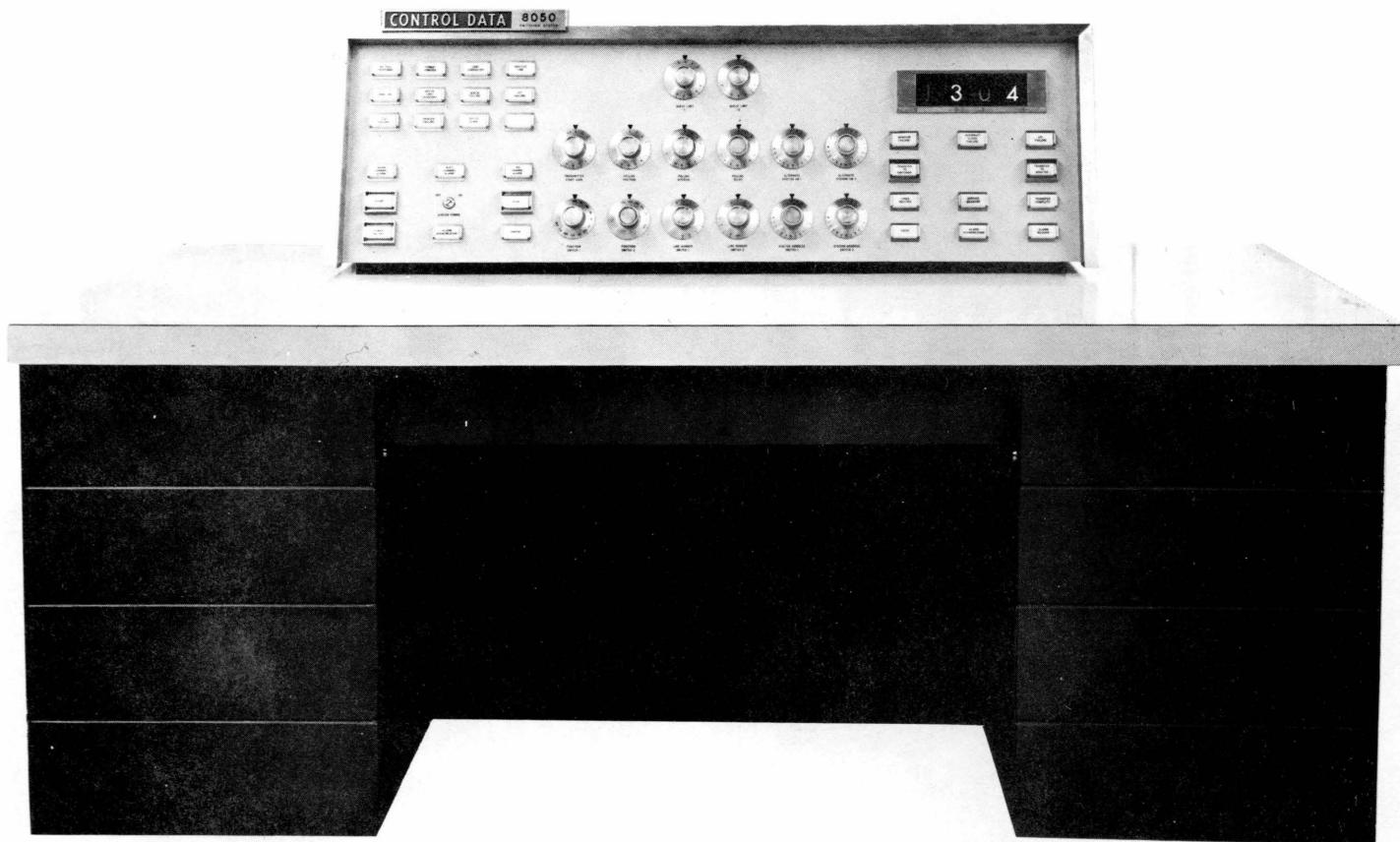

Figure 2-1

CONTROL DATA 8404 SYSTEM CONSOLE  
FOR AN 8050 INFORMATION CONTROL SYSTEM



## CHAPTER TWO

### 8404-A SYSTEM CONSOLE

The 8404-A System Console (figure 2-1) is the control center of the 8050 Information Control System . It provides the operator with an indication of system performance and the ability to change operation of the system. It is intended to permit a system operator with little or no knowledge of computer programming to introduce supervisor control information into the switcher computer. For example, stations may be removed from or added to the polling sequence at will. Another major function of the console is to display alarm conditions. A Time of Day Clock is located on the console panel and provides both visual and electrical outputs. When the switcher addresses the console it may read the time of day in increments of tenths of minutes.

Console switches are guarded to prevent accidental entry of information; that is, a prescribed sequence of manual operations is required to enter new constants into the switcher program.

Individual units housed within the console cabinet include the 8901-B Time of Day Clock, 8910 Dual-Computer Transfer Units, 8913 Peripheral Channel Monitors, Running-time meter and an 8606 Logic Power Supply.



2-2

Figure 2-2  
 CONTROL PANEL FOR THE  
 CONTROL DATA 8050  
 INFORMATION CONTROL SYSTEM

## OPERATIONAL SWITCHES AND INDICATORS

Information is first set on the input switches and then transferred to the 8050 system. A special safety feature requires that both ENTER switches be held depressed at the same time to initiate a transfer of information. When the program detects an operator ENTER, it must first input the computer words that describe the setting of the two function switches. The function switch settings may contain all the information necessary for the computer to respond to the operator-initiated interrupt. In some cases it may require the computer to input additional switch settings. The computer program is responsible for acquiring the proper switch settings and taking the appropriate actions. All switch and indicator locations are shown in Figure 2-2.

### STATUS SWITCHES

The various operational switches listed below are selected with Function Select Code 5600 (Gate Out Status) to clear their current condition.

#### START (Green)

The START switch is depressed for morning start-up. The program may be written so that the START switch interrupts the computer to initiate daily operations. The ENTER switches must be used to transfer the START information to the computer.

#### STOP (Red)

The STOP switch is depressed for shut-down and requests the computer to conclude daily operations. The ENTER switches must again be depressed to enter information.

### ENTER (White)

The ENTER switch is used to transfer new switch settings to the 8050 System. A special safety feature requires that both ENTER switches (Left and Right of Console) be held depressed at the same time to initiate a transfer of information.

## COMPUTER/MONITOR INDICATORS

### Monitor Failure (White)

The Monitor Failure lamp is automatically illuminated if the monitor computer fails to service the associated 8912 Reset Timer.

### Transfer to Monitor (Red)

The transfer to Monitor switch, connected to the Dual-Computer Transfer Unit, allows the system to be switched manually from the "Switcher computer" to the "Monitor computer".

### Transfer to Switcher (Green)

The Transfer to Switcher switch, connected to the Dual-Computer Transfer Unit, allows the message system to be switched manually from the "Monitor computer" to the "Switcher computer".

### Input/Output Failure (White)

If the monitor computer detects a failure in the switching Input/Output Units or Multiplexers it fails to service the 8912 Reset Timer. The operator is notified of the failure to service the 8912 Reset Timer by this indicator. If the monitor computer fails it will also be indicated on the I/O Failure lamp.

### Interrupt Clock Failure (White)

If an error is detected in the Interrupt 30 clock or in the function of any of its circuits an Interrupt Clock Failure will be signaled.

## PERIPHERAL MONITOR INDICATORS

The Normal, Buffer, and 169 Channel alarms are all contacts from the Peripheral Channel Monitor. Anytime an I/O device fails to respond to its Function Select code the Peripheral Channel Monitor responds for it and in doing so illuminates the specific alarm lamp. These alarms must be manually reset.

### Normal Channel Alarm (White)

This alarm indicates that a peripheral device on the normal channel has failed to respond to its Function Select code.

### Buffer Channel Alarm (White)

The Buffer Channel Alarm indicates that a peripheral device on the buffer channel has failed to respond to its Function Select code.

### 169 Channel Alarm (White)

This alarm indicates that any unit on the extended channel of the 169 Auxiliary Memory Unit has not responded properly to its Function Select code.

## OPERATOR ALARM SWITCHES

### ALARM ACKNOWLEDGE (White)

The alarm Acknowledge button is used by the operator to silence the audible alarm. This is done by clearing the ALARM flip flop. Either button is illuminated only when the indicator is depressed by the operator.

## ALARM SILENCE

The ALARM SILENCE button disables the audible alarm if an error persistently recurs.

## TIME OF DAY CLOCK

A complete description of the 8901-B Time of Day Clock is given in another section of this manual.

## Digital Display

A 24-hour digital display on the right of the operator's console indicates the time of day in minutes and hours.

## POWER SWITCHES

### System Key Lock

This lock is in series with the Power ON/OFF switch. When the lock is in the OFF position no power can be applied to the console. The clock remains running as it has a constant power source.

### Power ON/OFF (Green)

The Power switch, when depressed, indicates power ON with a green light and applies full power to the Console and units within the console. The Time of Day Clock has its own power source.

## RESTART LAMPS

The three restart lamps, Service Message, Lines Inactive, and Transfer Complete are used only during the restart operation. This group of lamps is sensed by Function Select code 5641 (Gate in Service Matrix).

### Service Message (White)

The Service Message indicator shows that the monitor computer is now sending a Service Message after replacing the switching computer. Whenever the monitor computer detects a "lost character" across its entire interface it makes a decision that either the Computer Transfer Switch failed, the switching computer failed, or that the auxiliary memory failed. The monitor computer then checks itself by a program of instruction. If the program is completed satisfactorily the Computer Transfer Switch is function addressed and it switches all the peripheral equipment to the new computer. When this is accomplished the message light goes on and remains on until after the service message is sent out.

### Lines Inactive (White)

The Lines Inactive light indicates that all communication lines are inactive. When the monitor computer takes over service the lines may be busy with incoming messages. The polled line traffic is terminated by not polling, but stations already polled will continue to send. When these previously initiated messages terminate and the single station lines acknowledge the Service Message by not sending, then an idle Status bit is set in the Input Unit which lights the Lines Inactive lamp.

### Transfer Complete (White)

The Transfer Complete indicator shows that the new computer on the line has fulfilled all requirements and is now ready to start polling and handling new traffic.

The monitor computer does not have the switching program in its memory; therefore it must go to the drum storage and read the switch program into core storage. This program is a duplicate of the program in the switching computer

and is up-dated at all times. As soon as the new computer has the switching program, it is ready to start polling for new traffic and for accepting messages. When this occurs, the Transfer Complete lamp is illuminated.

#### ALARM CONDITION LAMPS

The status of the Alarm Condition lamps is periodically up-dated by the computer program. The group of lamps is selected with Function Select code 5640 (Gate In Alarm Matrix) to clear their current conditions. This is followed by a 12-bit computer word containing a "one" in each position which is to be illuminated and a "zero" in each position which is to be extinguished. Initial illumination is a flashing white light. This condition persists until the lamp switch is depressed. At this time, if the alarm still exists, the lamp goes to a steady bright condition. If the alarm no longer exists when the lamp switch is depressed, the light goes out. When a lamp is in the steady bright condition it will not return to the flashing white condition without first being extinguished.

#### No Poll Response (White)

The No Poll Response signal indicates "no response" from a polled station. On full duplex lines the stations are polled for an inactive input channel by sending out a Transmitter Start Code (TSC). If a polled station does not respond by sending a "no message character (H)" it means that something is wrong. The program causes an alarm, lights the No Poll Response light, and prints out information on the Switcher RO. The operator should disable polling of the "no response" unit until the problem is corrected at the way station.



### Format Error (White)

This light indicates an incorrect code format on a message. If a message comes in and an incorrect Call Directing Code (CDC), an incorrect Start of Message (SOM), or an incorrect End of Message (EOM) code is detected the Format Error light is illuminated and the Switcher RO prints out the error involved.

### Lost Character (White)

If the computer should fail to pick up a character or if it detects a "lost character", the computer program puts a space in place of the character and goes on with the program. The Lost Character alarm notifies the operator that the computer has detected a lost character and the Switcher RO prints out this information.

### Inactive Line (White)

The Inactive Line alarm indicates that an erroneous Line Inactive signal occurred sometime between the start of a message and the end of the message. The Inactive Line signal is used to indicate end of tape after the end of a transmission symbol. Normally, a tape goes through and includes text, EOM code and EOT code. If the switching center were to start polling immediately after the End of Transmission code incoming traffic may be garbled, as an operator may insert a number of tape feed characters after the end of the message that would overlap the CDC of the next station's message. So the polled circuits must not only wait for EOT codes but also for the inactive line. This signal shows that the line is clear and that the computer can poll for new traffic.

A Line Inactive signal coming between the start of message and end of message is an error which lights the Inactive Line alarm and prints out the information on the Switcher RO.

### Open Line (White)

The open Line alarm indicates an abnormal condition caused by either a cut line or loss of electric current on an incoming line only. Whenever the alarm is given the information is printed out on the Switcher RO.

### Queue Limit Exceeded (White)

Each storage drum has a limited capacity and the computer notifies the operator that the pre-programmed capacity has been reached by causing a Queue Limit Exceeded alarm and print-out on the Switcher RO.

### Queue Failure (White)

The Queue alarm is given whenever the computer is unable to communicate with either queue system. The computer prints out, through the Switcher RO, information on which drum the queue failure occurred.

### DP Failure (White)

A data processing (DP) failure occurs whenever the computer fails to communicate with the 715 Data Exchange Unit. The letters, DP, form the Call Directing Code for messages that go to a remote system via the 715 Data Exchanger Unit. A print-out shows either Communication Channel Failure to DP, Parity Error to DP, or Tape Position Error at DP.

### DQ Failure (White)

The DQ refers to a Call Directing code used for inquiry messages going to a remote system via the 713 Data Exchange Unit. If communications with the 713 Data Exchange Unit break down the DQ Failure lamp is lit and a print-out is provided indicating Communication Channel Failure to DQ or No Reply from DQ.

### Printer Failure (White)

Top line information is printed on a high-speed printer. If for any reason the computer cannot communicate with the printer the Printer Failure lamp is lit and print-out occurs on the Switcher Teletype RO unit.

### Buffer Alarm (White)

Indicates inability to communicate with buffer channel. The Buffer Alarm light goes on and "Buffer Alarm" is printed out on the Switcher RO.

### Spare Alarm

This extra alarm button is fully wired, except for the information bit, and is included for future use.

## ROTARY SELECTOR SWITCHES

The fourteen Input rotary selector switches are located in the central portion of the operator's console. A complete description of the operation of the rotary selector switches is given in the next section, "Description of Operation of Rotary Selector Switches". Information is first set on the input rotary switches and then transferred to the 8050 system by holding both ENTER switches depressed at the same time.

### Function Switches

The Function Switch 1 is selected with Function code 5610 and is used to enter the following functions:

(IBY)	Initiate Busy
(TBY)	Terminate Busy
(IWI)	Initiate Willful Intercept
(TWI)	Terminate Willful Intercept
(IAR)	Initiate Alternate Route

(TAR)	Terminate Alternate Route
(QT1)	Queue Limit T1
(QT2)	Queue Limit T2
(QDP)	Queue Dump
(RCC)	Character Count
(EOM)	End of Message

The Function Switch 2 is selected with Function code 5611 and is used to enter the following additional functions:

(PSG)	Polling Sequence General
(PSP)	Polling Sequence Priority
(CPD)	Change Polling Delay
(CPI)	Change Polling Interval
(IPS)	Initiate Polling Station
(TPS)	Terminate Polling Station
(ESP)	Emergency Stop

#### Line Number Switches

Line Number Switch 1 and 2 are selected by Function codes 5616 and 5617 , respectively. Combination settings on these switches range from 00 to 99.

#### Station Address Switches

Each of the two Station Address Switches has 20 alphabetical positions. Combinations of these two switches allow a selection of 400 addresses. Switch 1 is selected by Function codes 5612 and 5613; switch 2 by codes 5614 and 5615.

#### Alternate Station Address Switches

Combination of both Alternate Station Address switches allow a selection of 400 alternate addresses. Alternate switch 1 is selected by Function codes 5622 and 5623; alternate switch 2 by codes 5624 and 5630.

#### Polling Delay Switch

The Polling Delay switch contains 12 numerical positions that can be multiplied by

a constant provided by the computer program. The Polling Delay switch is selected by Function code 5634.

#### Polling Interval Switch

The Polling Interval switch contains 12 numerical interval positions that can be multiplied by a constant provided in the program. The switch is selected by code 5633.

#### Polling Position Switch

The Polling Position switch contains 12 numerical positions that can be multiplied by a programmed constant to give a complete range of polling positions. The switch is selected by code 5632.

#### Transmitter Start Code Switch

The Transmitter Start Code switch contains a BLANK and 10 Transmitter Start code positions. It is selected by Function code 5631.

#### Queue Limit Switches

The Queue Limit switches contain 12 numerical positions that can be multiplied by a programmed constant to give a complete range of queue limit numbers. The two switches service two storage units. Switch 1 is selected by code 5620 and switch 2 by code 5621.

## OPERATION OF SELECT SWITCHES

The following section gives the operator a step-by-step procedure for performing the various functions necessary for the operation of the message switching center. A complete description of the console switches and indicators is given in the section "Operational Switches and Indicators".

### Initiate Willful Intercept - (IWI)

To place any station or line on Willful Intercept, make the following settings and depress both ENTER buttons:

Function Switch #1	IWI - Initiate Willful Intercept
Function Switch #2	Off
Station Address #1 & #2	To the desired station
Line Number #1 & #2	Off

To place a line on Willful Intercept, set the line number and set both Station Address Switches to "OFF".

### Terminate Willful Intercept - (TWI)

To remove any station or line from Willful Intercept, make the following settings and depress both ENTER buttons:

Function Switch #1	TWI - Terminate Willful Intercept
Function Switch #2	Off
Station Address #1 & #2	To the desired station
Line Number #1 & #2	Off

To remove any line from Willful Intercept, set the line number and set both Station Address Switches to "OFF".

Queue Dump - (QDP)

To dump the active contents of the Queue drums on the intercept system, make the following settings and depress both ENTER buttons:

Function Switch #1	QDP - Queue Dump
Function Switch #2	OFF

Polling Sequence General (PSG)

To change the polling sequence, make the following settings and depress both ENTER buttons:

Function Switch #1	Off
Function Switch #2	PSG - Polling Sequence General
Transmitter Start Code	To appropriate Transmitter Start Code
Polling Position	To the desired position (one thru twelve) in the list.
Line Number #1 & #2	To the desired line number

Change Polling Delay (CPD)

To change the Polling Delay, make the following settings and depress both ENTER buttons:

Function Switch #1	Off
Function Switch #2	CPD - Change Polling Delay
Polling Delay	To the desired delay before initiating the polling sequence.

Change Polling Interval - (CPI)

To change the polling interval, make the following settings and depress both ENTER buttons:

Function Switch #1	Off
Function Switch #2	CPI - Change Polling Interval
Polling Interval	To the desired interval before the repolling of a line after a "no traffic" response to a complete polling cycle.

Terminate Polling Station - (TPS)

Function Switch #1	Off
Function Switch #2	TPS - Terminate Polling Station
Transmitter Start Code	To the desired TSC
Line #1 & #2	To the desired line number

It is also possible to terminate polling of a station by removing its TSC from the polling sequence list directly.

Initiate Polling Station - (IPS)

To initiate polling of any station, make the following settings and depress both ENTER buttons:

Function Switch #1	Off
Function Switch #2	IPS - Initiate Polling Station
Transmitter Start Code	To the desired TSC
Line Number #1 & #2	To the desired Line Number

It is also possible to initiate polling of a station by adding its TSC to the polling sequence list directly.

Initiate Alternate Route - (IAR)

To select an alternate route for any station, make the following settings and depress both ENTER buttons:

Function Switch #1	IAR - Initiate Alternate Routing
Function Switch #2	Off
Station Address #1 & #2	To the station that will discontinue to receive messages.
Alternate Station Address #1 & #2	To the station that will continue to receive its own messages and those of the other station.



### Terminate Alternate Route - (TAR)

To terminate an alternate route for any station, make the following settings and depress both ENTER buttons:

Function Switch #1  
Function Switch #2  
Station Address #1 & #2

TAR - Terminate Alternate Route  
Off  
To the station that will begin to receive its own messages.

Alternate Station  
Address #1 & #2

To the station which has been receiving its own traffic and that of the other station.

### Queue Limit T1 - (QT1)

To set the Queue Limit T1, make the following settings and depress both ENTER buttons:

Function Switch #1  
Function Switch #2  
Queue Limit T1

QT1 - Queue Limit T1  
Off  
To the desired time interval a message may remain in queue before outgoing time is added to top line printing of that message.

### Queue Limit T2 - (QT2)

To set the Queue Limit T2, make the following settings and depress both ENTER buttons:

Function Switch #1  
Function Switch #2  
Queue Limit T2

QT2 - Queue Limit T2  
Off  
To the desired time interval over and above T1 that a message may remain in queue before it may be automatically directed to intercept and a top line printing of the message is initiated.

Character Count - (RCC)

To initiate a Switcher RO printer report of all current character counts, make the following settings and depress both ENTER buttons:

Function Switch #1	RCC - Record Character Count
Function Switch #2	Off

End of Message - (EOM)

To send an end of message code to any outgoing line, make the following settings and depress both ENTER buttons:

Function Switch #1	EOM - End of Message
Function Switch #2	Off
Station Address #1 & #2	Off
Line Number #1 & #2	To the desired outgoing line

Emergency Stop - (ESP)

To emergency stop any transmitter, make the following settings and depress both ENTER buttons:

Function Switch #1	Off
Function Switch #2	ESP - Emergency Stop
Station Address #1 & #2	Off
Line Number #1 & #2	To the desired outgoing line number

Initiate Busy - (IBY)

To "busy out" any outgoing line or station, make the following settings and depress both ENTER buttons:

Function Switch #1	IBY - Initiate Busy
Function Switch #2	Off
Station Address #1 & #2	To the desired station
Line Number #1 & #2	Off

To place a line on busy, set the line number switches and set both Station Address Switches to "OFF".

Terminate Busy - (TBY)

To take any outgoing line or station off busy, make the following settings and depress both ENTER buttons:

Function Switch #1	TBY - Terminate Busy
Function Switch #2	Off
Station Address #1 & #2	To the desired station
Line Number #1 & #2	Off

To take an outgoing line off busy, set the line number switches, and set both Station Address Switches to "OFF".

Perform Special Procedure - (PSP)

To restore either Drum A or Drum B to an operating condition:

Function Switch #1	OFF
Function Switch #2	PSP
Queue Limit T <sub>1</sub>	1

To restore communication with DQ:

Function Switch #1	OFF
Function Switch #2	PSP
Queue Limit T <sub>1</sub>	2

To restore the Top line printing function:

Function Switch #1	OFF
Function Switch #2	PSP
Queue Limit T <sub>1</sub>	3

To restore communication with DP:

Function Switch #1	OFF
Function Switch #2	PSP
Queue Limit T <sub>1</sub>	4

## OPERATOR INFORMATION RO PRINT-OUTS

Two RO page printers are associated with the operator's console. The one associated with the switcher computer is called the Switching RO and the one associated with the Monitor computer is called the Monitor RO. Each print-out includes the time of day (TI:ME) and the message as shown in the following print-out examples:

### SWITCHER RO PRINT-OUTS

#### Operator Initiated Commands

##### Initiate Willful Intercept - (IWI)

Print-Out: TI:ME Initiated willful intercept station EE  
Print-Out: TI:ME Initiated willful intercept line YY.

##### Terminate Willful Intercept - (TWI)

Print-Out: TI:ME Terminated willful intercept station EE  
Print-Out: TI:ME Terminated willful intercept line YY.

##### Queue Dump - (QDP)

Print-Out: TI:ME Queue Dump Initiated

##### Polling Sequence General - (PSG)

Print-Out: TI:ME General traffic polling sequence line YY changed.  
TCS now: TTTT, etc.

##### Change Polling Delay - (CPD)

Print-Out: TI:ME Polling delay changed to N.N minutes.

##### Change Polling Interval - (CPI)

Print-Out: TI:ME Polling interval changed to N.N minutes.

Terminate Polling Station - (TPS)

Print-Out: TI:ME Terminated polling of TSC T on line YY.

Initiate Polling Station - (IPS)

Print-Out: TI:ME Initiated polling of TSC T on line YY.

Initiate Alternate Route - (IAR)

Print-Out: TI:ME Initiated alternate routing of station EE to station ee.

Terminate Alternate Routing - (TAR)

Print-Out: TI:ME Terminated alternate routing of station EE to station ee.

Queue Limit T1 - (QT1)

Print-Out: TI:ME Message in Queue time limit T1 set at N.N minutes.

Queue Limit T2 - (QT2)

Print-Out: TI:ME Message in Queue Time Limit T2 set at N.N minutes.

Character Count - (RCC)

Print-Out: TI:ME Requested character count of system.

Inbound Traffic: Line YY  
TSC T MMM, MMM, etc.

Line YY MMM, MMM (single  
station sending)

Outbound Traffic: Line YY MMM, MMM etc.

End of Message - (EOM)

Print-Out: TI:ME End of message generated to clear line YY.

Emergency Stop - (ESP)

Print-Out: TI:ME Emergency stop generated to stop transmitter on line YY.

Initiate Busy - (IBY)

Print-Out: TI:ME Station EE placed in busy condition.  
Print-Out: TI:ME Line YY placed in busy condition.

Terminate Busy - (TBY)

Print-Out: TI:ME Station EE previous busy condition terminated.  
Print-Out: TI:ME Line YY previous busy condition terminated.

Perform Special Procedure - (PSP)

Print-Out: TI:ME Drum now operative  
Print-Out: TI:ME DQ Link now operative  
Print-Out: TI:ME Top Line Printer now operative  
Print-Out: TI:ME DP Link now operative

Switcher Initiated Command

Polling

Print-Out: TI:ME No response to polling line YY TSC T.

Monitoring of Incoming Messages

Print-Out: TI:ME Invalid header received from line YY TSC T.  
Print-Out: TI:ME Repetitious characters received from line YY TSC T.  
Print-Out: TI:ME Message format error from line YY TSC T.

Lost Character

Print-Out: TI:ME Lost Character on line YY TSC T.

Input Inactive

Print-Out: TI:ME Line inactive TSC T.

### Open Line

Print-Out: TI:ME Line YY open.

### Queueing Limits

Print-Out: TI:ME Queue storage upper limit exceeded.

Print-Out: TI:ME Queue storage below lower limit.

### Drum Failure

Print-Out TI:ME Queue failure drum A (or B).

### Invalid Dial Settings

Print-Out: TI:ME Invalid Operators Console setting.

Note: See cases A through H in Appendix B.

### Console Hardware Error

Print-Out: TI:ME Console Switch Failure Entry Ignored.

### DP Code (715 DXU) Error

Print-Out: TI:ME Communication Channel failure to DP.

Print-Out: TI:ME Parity error to DP.

Print-Out: TI:ME Tape Position error at DP.

### DQ Code (713 DXU)

Print-Out: TI:ME Communication Channel failure to DQ.

Print-Out: TI:ME No reply from DQ.

### Top Line Printer

Print-Out: TI:ME Top line printer failure.

### Monitor-Switcher Transfer

Print-Out: TI:ME Communications switcher transfer.

### Buffer Alarm

Print-Out: TI:ME Buffer Alarm

## MONITOR RO PRINT-OUTS

### Monitor Functions

Print-Outs:	TTU failure line YY.
Print-Outs:	Multiplexer failure input slave multiplexer number na.
Print-Outs:	Multiplexer failure output slave multiplexer number na.
Print-Outs:	Multiplexer failure master multiplexer number n.
Print-Outs:	Master computer transfer switch failure.
Print-Outs:	Computer transfer switch failure.



## OPERATION OF CONSOLE

### MORNING START-UP AND EVENING SHUT-DOWN PROCEDURES

#### Start-Up

Some Communication Systems span more than one time zone starting, for example, with a station in the Eastern Time Zone. Beginning with initial start-up, the time-zoned stations are brought on the air at one hour intervals. Until a receiving station is on the air, outgoing traffic to that station is held in queue storage. When a time zone comes on the air, all stations (including those operating in the unattended mode) in that area are sent a "Good Morning" broadcast. The stations are not required to acknowledge the "Good Morning" broadcast before sending messages to and receiving messages from the Switching Center. As each comes on the air, it is indicated to the operator via the Switcher RO. If, for any reason, a station cannot operate in the unattended mode, it is the responsibility of the system operator to place the station on willful intercept and maintain the intercept until the station requests to be placed on the air, either via a Good Morning response or a service message. The system retrieves any messages remaining in Queue storage at time of start-up and switches those messages as the stations come on the air.

#### Shut-Down

Stations shut down at one hour intervals according to their time zones in the reverse of the procedures outlined in Start-up. If the operator wishes to send to any unattended station he must manually remove the station from busy.

### System Status During Inoperative Hours

The system normally switches traffic either to its destination or to intercept before shut-down. Any messages remaining in queue are held and switched at start-up. Security of the messages can be affected by improper shut-down and start-up of the system. Therefore it is imperative that proper procedures be followed in the computer operation.

### System Status at Start-Up

At start-up all system variables such as the queue dictionary, drum availability list, and operator actions are reset to the values of the night before. If the start button is depressed at start-up and the enter buttons have been depressed, previously set parameters will take affect, otherwise standard built-in parameters will be used.

## OPERATOR OPTIONS

The operator's console allows the operator complete control of the system. All system conditions needed by the operator are displayed via both visual and audible annunciators. The system records all operator actions, system alarms, and time of day of occurrence on the Switcher RO page printer. Hardware alarms are indicated on the Monitor RO page printer or with indications on the System Console.

The system operator may perform any of the following functions:

1. Divert any station or line traffic to willful intercept.
2. Adjust the message queue holding time that is used to initiate top-line printing of outgoing messages that have waited in Queue T1 minutes.

3. Adjust the message queue holding time that is used to initiate intercept printing of outgoing messages that have been in Queue T1 plus T2 minutes.
4. Select a queue dump to the intercept system for the entire switching system. This clears the queue drum memory and all the messages in the system are considered switched. This can only be done when the system is not in the normal switching mode.
5. Change the channel polling sequence. The polling sequence is determined by a table of TSCs which the computer reads.
6. Polling including initiation of polling and termination of polling.
7. Alternate routing. The system replaces the "called" station's Call Directing Code (CDC) in the message header with the alternate stations CDC and routes the message to the outgoing line of the alternate station. All messages in queue for the called station prior to selection of alternate routing are not routed direct to the alternate station, but remain in the system and are handled by other system features. All alternately routed messages in queue prior to termination of the alternate routing of the called station are sent to the alternate station or handled by some other system feature.
8. Introduce messages into the system.
9. Initiate emergency stop sequence for any outbound line.
10. Busy-out stations and lines.
11. Alarm. All system alarms activate a visual and audible signal and must be acknowledged by the system operator. Pressing the alarm acknowledge button changes the flashing annunciator light to steady bright and silences the audible alarm. When the condition returns to normal, the light goes out. Full listing and descriptions of all alarms are given under "Operational Switches and Indicators".

12. Two RO page printers are associated with the operator's console. One RO is associated with the switching computer and is called the Switching RO. The other RO is associated with the monitor computer and is called the Monitor RO. Each report on the Switcher RO includes the time of day. Full details are given in the "Switcher and Monitor RO Print-Out" section.
13. Change the polling interval in increments of 12 seconds. The polling interval cannot exceed 2 minutes.
14. Change polling delay in increments of six seconds. The polling delay cannot exceed 1 minute nor can it be zero.
15. Transfer the system from the switcher computer to the Monitor computer or vice versa with switches on the operator's console.
16. Generate EOM for any incoming line.

## DESCRIPTION OF FUNCTIONS

### RESTART

When the monitor computer recognizes failure in the computer transfer switch or the switching computer, it takes over the switching function automatically. The monitor computer first performs a maintenance test upon itself. If the test of its functions is successful, it switches system control to itself. Then it sends a service message to all stations requesting that all messages in progress at the time of failure be sent again. It then scans all incoming channels and waits for inactive line status on all channels. Next it addresses the drum system and reads in the switching program, polling list, header list, message queue list and other parameters existing in the switching computer at the last recording prior to failure. All of these parameters are updated and stored on all system drums. As the restart proceeds, its progress will be reported to the system operator with lamp indications on the console. (See section on Restart Lamps.)

### MONITOR FUNCTIONS

By periodically sampling the lost character signals the monitor computer is able to diagnose, alarm, and report failures in any of the Input/Output units, MUXs, computer transfer switches, switching computer, or monitor computer. If an Input/Output unit or MUX failure is detected, the operator is instructed to change the failed unit. If the switching computer or computer transfer switch fails, the monitor transfers the switching function to itself. All of these failures are reported to the operator. If the monitor computer should fail, the I/O Failure, Interrupt Clock failure, and monitor failure lights on the operator's console are lighted and an alarm is sounded. There is no type-out for this condition.

If lost characters are detected across the entire interface, the I/O Failure Lamp is lighted and the condition is reported on the Monitor RO.

## INTERCEPT

There are two intercept systems of ROTRs. The classes of intercepted messages and the methods of handling are:

### Normal

This class consists of those messages which are proper and could be switched normally by the system. They are sent to the normal intercept ROTR system. These messages are intercepted in the format as received. There is no indication on the switcher RO of these messages.

### Abnormal

This class consists of messages which contain errors that cannot be handled by the system. They are sent to the abnormal intercept ROTR. These messages are intercepted in the format as received. They are indicated on the switcher RO.

## TOP LINE RECORDING

### Normal Top Line Printing

Each message as it enters the system is given a time of receipt associated with its entry into the center. Each time the message is switched, the following information is recorded on the top line printer:

Time in	Blank	Outgoing Line #	Called CDC's	Calling CDC	DATE	TIME
------------	-------	--------------------	-----------------	----------------	------	------

"Top Line of Message"

166-2 Printer

2-29

### Abnormal Top Line Printing

If a message is delayed in the system beyond a program time constant (may be modified by the operator) the blank space left in the normal top line message format is filled in by a time of transmission.

## FUNCTION SELECT CODES AND SWITCH SETTINGS

The CONTROL DATA 8050 Message and Data Switching System Function

Select codes are as follows:

	(octal)
Input Status	5600
Input Clock Function	5601, 5602
Input Switch Function	5610 through 5637
Output Function	5640 through 5647
Select Transfer Switch	570X
Status Select Code	571X

### FUNCTION CODE 5600 - GATE OUT STATUS

Bit 0 through 7	-Zero
Bit 8	-START
Bit 9	-STOP
Bit 10	-Operator ENTER
Bit 11	-Time Ambiguous

### FUNCTION CODE 5601 - GATE OUT TIME

Bit 0 through 3	-10's of minutes
Bit 4 through 7	-1's of hours
Bit 8 through 11	-10's of hours

### FUNCTION CODE 5602 - GATE OUT TIME

Bit 0 through 3	-.1's of minutes
Bit 4 through 7	-1's of minutes
Bit 8 through 11	-Not used (zeros)

### FUNCTION CODE 5610 - GATE OUT FUNCTION SWITCH #1 CONTENTS

Bit 0	-(IBY) Initiate Busy
Bit 1	-(TBY) Terminate Busy
Bit 2	-(IWI) Initiate Willful Intercept
Bit 3	-(TWI) Terminate Willful Intercept
Bit 4	-(IAR) Initiate Alternate Route
Bit 5	-(TAR) Terminate Alternate Route
Bit 6	-(QT1) Queue Limit T1
Bit 7	-(QT2) Queue Limit T2
Bit 8	-(QDP) Queue Dump
Bit 9	-(RCC) Character Count
Bit 10	-(EOM) End of Message
Bit 11	-OFF



FUNCTION CODE 5611 - GATE OUT FUNCTION SWITCH #2 CONTENTS

Bit 0	-(PSG) Polling Sequence General
Bit 1	-(PSP) Polling Sequence Priority
Bit 2	-(CPD) Change Polling Delay
Bit 3	-(CPI) Change Polling Interval
Bit 4	-(IPS) Initiate Polling Station
Bit 5	-(TPS) Terminate Polling Station
Bit 6	-(ESP) Emergency Stop
Bit 7 through 10	-(SP-) Spares
Bit 11	-OFF

FUNCTION CODE 5612 - GATE OUT 12 POSITIONS OF STATION ADDRESS SWITCH #1

	-OFF
Bit 0	-A
Bit 1	-B
Bit 2	-C
Bit 3	-D
Bit 4	-E
Bit 5	-F
Bit 6	-G
Bit 7	-I
Bit 8	-J
Bit 9	-K
Bit 10	-L
Bit 11	-N

FUNCTION CODE 5613 - GATE OUT 8 POSITIONS OF STATION ADDRESS SWITCH #1

	-OFF
Bit 0	-P
Bit 1	-Q
Bit 2	-R
Bit 3	-S
Bit 4	-U
Bit 5	-W
Bit 6	-X
Bit 7	-Y
Bit 8 through 11	-Unassigned

FUNCTION CODE 5614 - GATE OUT 12 POSITIONS OF STATION ADDRESS SWITCH #2

	-OFF
Bit 0	-A
Bit 1	-B
Bit 2	-C
Bit 3	-D
Bit 4	-E
Bit 5	-F
Bit 6	-G
Bit 7	-I
Bit 8	-J
Bit 9	-K
Bit 10	-L
Bit 11	-N

FUNCTION CODE 5615 - GATE OUT 8 POSITIONS OF STATION ADDRESS SWITCH #2

	-OFF
Bit 0	-P
Bit 1	-Q
Bit 2	-R
Bit 3	-S
Bit 4	-U
Bit 5	-W
Bit 6	-X
Bit 7	-Y
Bit 8 through 11	-Unassigned

FUNCTION CODE 5616 - GATE OUT CONTENTS OF LINE NUMBER SWITCH #1

Bit 0	-0
Bit 1	-1
Bit 2	-2
Bit 3	-3
Bit 4	-4
Bit 5	-5
Bit 6	-6
Bit 7	-7
Bit 8	-8
Bit 9	-9
Bit 10	-Unassigned
Bit 11	-Unassigned

FUNCTION CODE 5617 - GATE OUT CONTENTS OF LINE NUMBER SWITCH #2

Bit 0	-0
Bit 1	-1
Bit 2	-2
Bit 3	-3
Bit 4	-4
Bit 5	-5
Bit 6	-6
Bit 7	-7
Bit 8	-8
Bit 9	-9
Bit 10	-Unassigned
Bit 11	-Unassigned

FUNCTION CODE 5620 - GATE OUT CONTENTS OF QUEUE LIMIT T1 SWITCH

Bit 0	-1
Bit 1	-2
Bit 2	-3
Bit 3	-4
Bit 4	-5
Bit 5	-6
Bit 6	-7
Bit 7	-8
Bit 8	-9
Bit 9	-10
Bit 10	-11
Bit 11	-12

FUNCTION CODE 5621 - GATE OUT CONTENTS OF QUEUE LIMIT T2 SWITCH

Bit 0	-1
Bit 1	-2
Bit 2	-3
Bit 3	-4
Bit 4	-5
Bit 5	-6
Bit 6	-7
Bit 7	-8
Bit 8	-9
Bit 9	-10
Bit 10	-11
Bit 11	-12

FUNCTION CODE 5622 - GATE OUT 12 POSITIONS OF ALTERNATE STATION ADDRESS SWITCH #1

	-OFF
Bit 0	-A
Bit 1	-B
Bit 2	-C
Bit 3	-D
Bit 4	-E
Bit 5	-F
Bit 6	-G
Bit 7	-I
Bit 8	-J
Bit 9	-K
Bit 10	-L
Bit 11	-N

FUNCTION CODE 5623 - GATE OUT 8 POSITIONS OF ALTERNATE STATION ADDRESS SWITCH #1

Bit 0	-P
Bit 1	-Q
Bit 2	-R
Bit 3	-S
Bit 4	-U
Bit 5	-W
Bit 6	-X
Bit 7	-Y
Bit 8	-Unassigned
Bit 9	-Unassigned
Bit 10	-Unassigned
Bit 11	-Unassigned

FUNCTION CODE 5624 - GATE OUT 12 POSITIONS OF ALTERNATE STATION ADDRESS SWITCH #2

	-OFF
Bit 0	-A
Bit 1	-B
Bit 2	-C
Bit 3	-D
Bit 4	-E
Bit 5	-F
Bit 6	-G
Bit 7	-I
Bit 8	-J
Bit 9	-K
Bit 10	-L
Bit 11	-N

FUNCTION CODE 5630 - GATE OUT 8 POSITIONS OF ALTERNATE STATION ADDRESS SWITCH #2

Bit 0	-P
Bit 1	-Q
Bit 2	-R
Bit 3	-S
Bit 4	-U
Bit 5	-W
Bit 6	-X
Bit 7	-Y
Bit 8	-Unassigned
Bit 9	-Unassigned
Bit 10	-Unassigned
Bit 11	-Unassigned

FUNCTION CODE 5631 - GATE OUT 8 POSITIONS OF ALTERNATE STATION ADDRESS SWITCH #2

Bit 0	-BLK
Bit 1	-A
Bit 2	-S
Bit 3	-I
Bit 4	-D
Bit 5	-R
Bit 6	-H
Bit 7	-Z
Bit 8	-L
Bit 9	-N
Bit 10	-O
Bit 11	-Unassigned

FUNCTION CODE 5632 - GATE OUT CONTENTS OF POLLING POSITION SWITCH

Bit 0	-1
Bit 1	-2
Bit 2	-3
Bit 3	-4
Bit 4	-5
Bit 5	-6
Bit 6	-7
Bit 7	-8
Bit 8	-9
Bit 9	-10
Bit 10	-11
Bit 11	-12

FUNCTION CODE 5633 - GATE OUT CONTENTS OF POLLING INTERVAL SWITCH

Bit 0	-1
Bit 1	-2
Bit 2	-3
Bit 3	-4
Bit 4	-5
Bit 5	-6
Bit 6	-7
Bit 7	-8
Bit 8	-9
Bit 9	-10
Bit 10	-11
Bit 11	-12

FUNCTION CODE 5634 - GATE OUT CONTENTS OF POLLING DELAY SWITCH

Bit 0	-0
Bit 1	-1
Bit 2	-2
Bit 3	-3
Bit 4	-4
Bit 5	-5
Bit 6	-6
Bit 7	-7
Bit 8	-8
Bit 9	-9
Bit 10	-10
Bit 11	-11

FUNCTION CODE 5640 - GATE IN ALARM MATRIX

Bit 0	-No Poll Response
Bit 1	-Format Errors
Bit 2	-Lost Character
Bit 3	-Inactive Line
Bit 4	-Open Line
Bit 5	-Queue Limit Exceeded
Bit 6	-Queue Alarm
Bit 7	-DP Failure
Bit 8	-DQ Failure
Bit 9	-Printer Failure
Bit 10	-Buffer Alarm
Bit 11	-Spare

FUNCTION CODE 5641 - GATE IN SERVICE MATRIX

Bit 0	-Service Message
Bit 1	-Lines Inactive
Bit 2	-Transfer Complete
Bit 3	-Reset Enter F.F.
Bit 4	-Unassigned
Bit 5	-Unassigned
Bit 6	-Unassigned
Bit 7	-Unassigned
Bit 8	-Unassigned
Bit 9	-Unassigned
Bit 10	-Unassigned
Bit 11	-Unassigned

FUNCTION CODE 5642 - SOUND AUDIBLE ALARM

(Note: Computer does not turn off the Audible Alarm.)

FUNCTION CODE 570X - SELECT TRANSFER SWITCH  
(Computer Transfer Switch)

5700	Select Transfer Switch #1
5701	Select Transfer Switch #2
5702	Select Transfer Switch #3 (Reserved)
5703	Select Transfer Switch #4 (Reserved)

FUNCTION CODE 571X - STATUS REQUEST  
(Computer Transfer Switch)

5710	Status Request Switch #1
5711	Status Request Switch #2
5712	Status Request Switch #3 (Reserved)
5713	Status Request Switch #4 (Reserved)

## PERIPHERAL CHANNEL MONITOR

The Peripheral Channel Monitor (PCM) is a device that monitors the Switcher Input/Output channels. The computer program always checks the status of an I/O device prior to and after use. The computer will take appropriate action based on the responses to status request. In the event that any peripheral unit on that channel fails to respond to the switcher in the normal interval, an automatic alarm results. At the same time, the Peripheral Channel Monitor generates a pseudo-response (Output Resume or Input Ready) that keeps the system from being stalled. Each channel or class of peripheral devices that has a different response time must have its own Peripheral Channel Monitor Circuit. The PCMs are installed on the System Console logic chassis.

### DESCRIPTION

In this 8050 system three Peripheral Channel Monitors keep watch on three channels: Channel A (the 169 Channel), Channel B (the Normal Channel) and, Channel C (the Buffer Channel). See logic drawings 360293, sheets 1 through 3.

### OPERATION

Each PCM monitors three signal lines from the 160-A computer:

1. Function Ready (Output line)
2. Information Ready (Output line)
3. Input Request (Input line)

### Signal Functions

The signals described below are involved in the operation of the Peripheral Channel Monitor.

#### FUNCTION READY

This signal accompanies each EXTERNAL FUNCTION CODE output from the computer. The addressed peripheral device is expected to reply within a few microseconds, with an OUTPUT RESUME signal, which causes the FUNCTION READY to drop, and the program to continue.



INFORMATION READY

This signal accompanies each DATA WORD output from the computer. The addressed peripheral device is expected to reply, within a few microseconds, with an OUTPUT RESUME signal, which causes the INFORMATION READY to drop, and the program to continue.

INPUT REQUEST

This signal is generated by the computer on its input line to inform the external equipment that the computer desires an input word. The addressed peripheral device is expected to reply, within a few microseconds, with an INPUT READY signal, which causes the INPUT REQUEST to drop, and the program to continue.

ALARM

The ALARM function is generated by a relay which places a ground on the ALARM signal line. At the indicator panel, a lamp or audible alarm device may be used to signal the operator. The ALARM is cleared only by operator action.

When the computer sends a FUNCTION READY, INFORMATION READY or INPUT REQUEST signal to peripheral equipment the signal also enters the PCM. It is subject immediately to a delay to allow all the accompanying bits of code or data enough time to enter the peripheral units. In the PCM the signal takes two paths --

--it sets the Alarm-Clear Flip Flop which disables the clearing input of the Signal-and-Alarm-Control Flip Flop. The Alarm-Clear Flip Flop also adds its signal to AND gates for the OUTPUT RESUME and INPUT READY signals.

--it sets the Signal-and-Alarm-Control Flip Flop after a delay. This delay is adjustable and should be set for a duration to exceed the normal answering time of the slowest-answering peripheral device in the channel. When the flip-flop is set, it in turn sets the Channel Alarm Flip Flop which closes the Alarm Relay and sends an Alarm signal to the System Console.

The Signal-and-Alarm-Control Flip Flop also adds its signal to AND gates for the OUTPUT RESUME and INPUT READY signals.

If the addressed peripheral device replies to a computer properly and within a normal waiting period, the PCM does not operate. Its Flip Flops are reset. Normally a peripheral device replies to a 160-A computer as shown in the chart below:

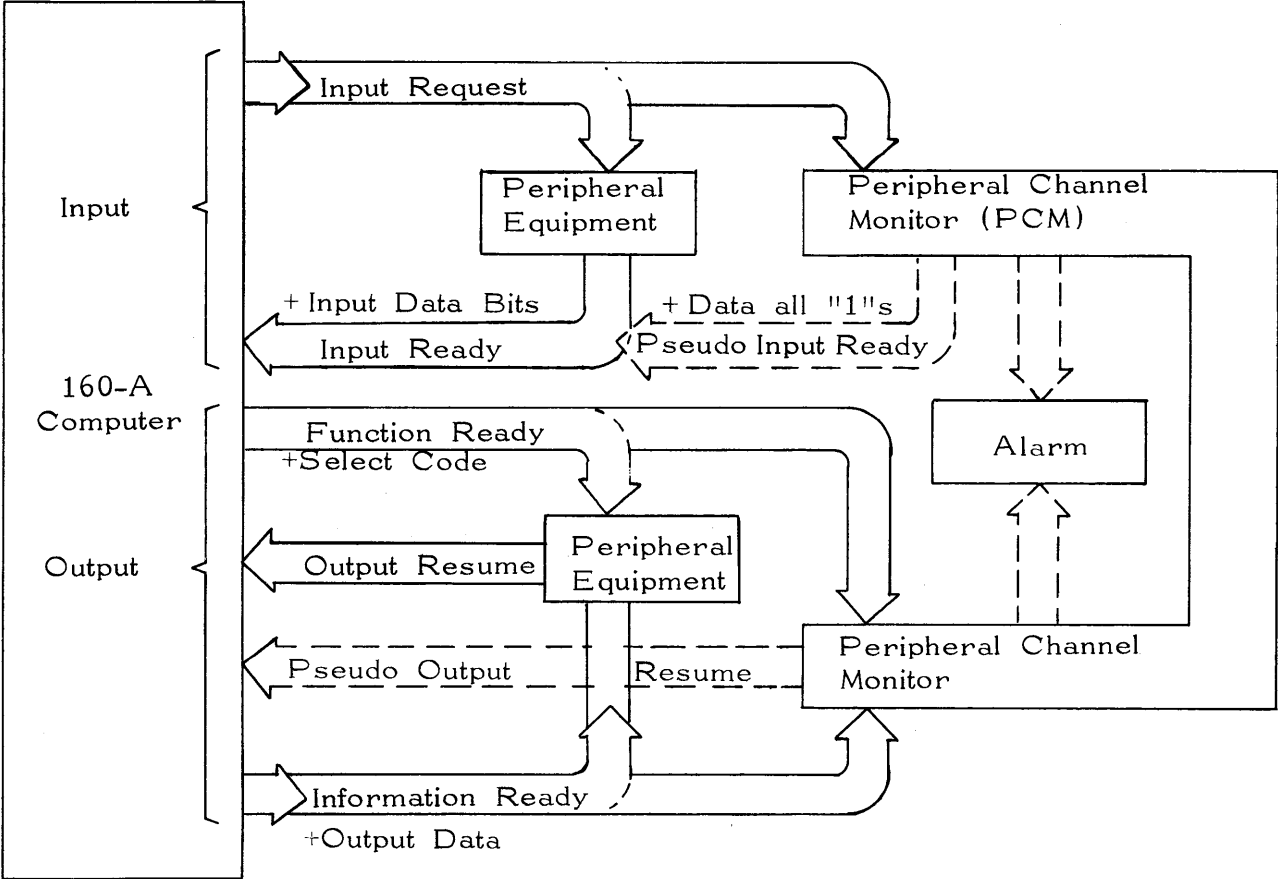

PERIPHERAL CHANNEL MONITOR FLOWCHART

If the Peripheral equipment does not respond within the alarm delay period, the associated alarm goes off; the PCM sends a pseudo reply to the computer.



## CHAPTER THREE

### COMPONENT UNITS IN THE 8050 SYSTEM

This chapter describes the operation and operational procedures regarding several units which are important parts of the CONTROL DATA 8050 Information Control System. These units include the Multiplexer and its component units; the Time of Day Clock, and Dual Computer-Transfer Unit located in the System Console; and the Test Board Unit. Each unit is covered individually in its own section. They are positioned in numerical order, 8155 Multiplexer through 8912 Reset Timer. See the Table of Contents for the complete list of units covered in this chapter.



**CONTROL DATA  
8155 MULTIPLEXER**

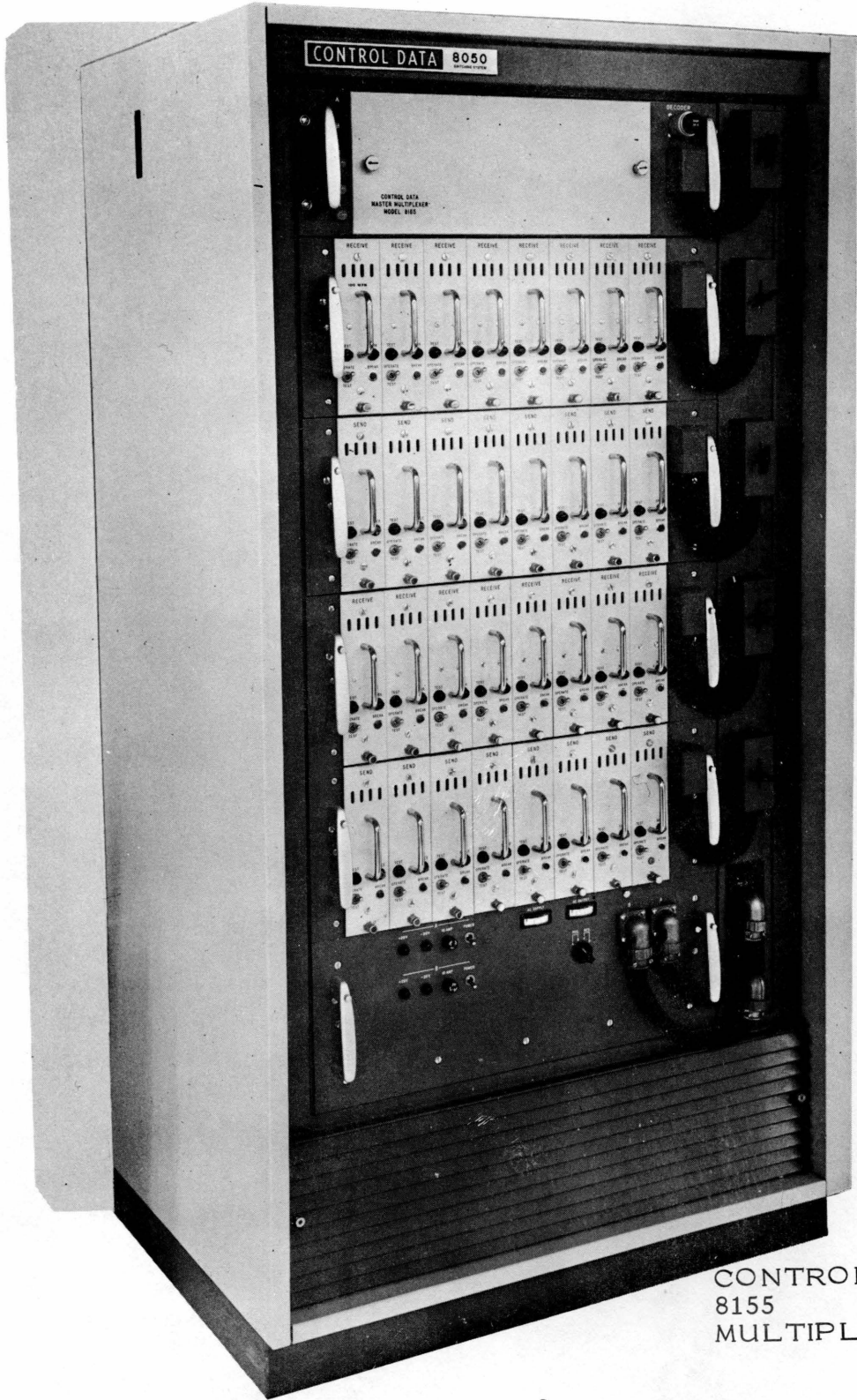

CONTROL DATA  
8155  
MULTIPLEXER CABINET

Two Views of Frame

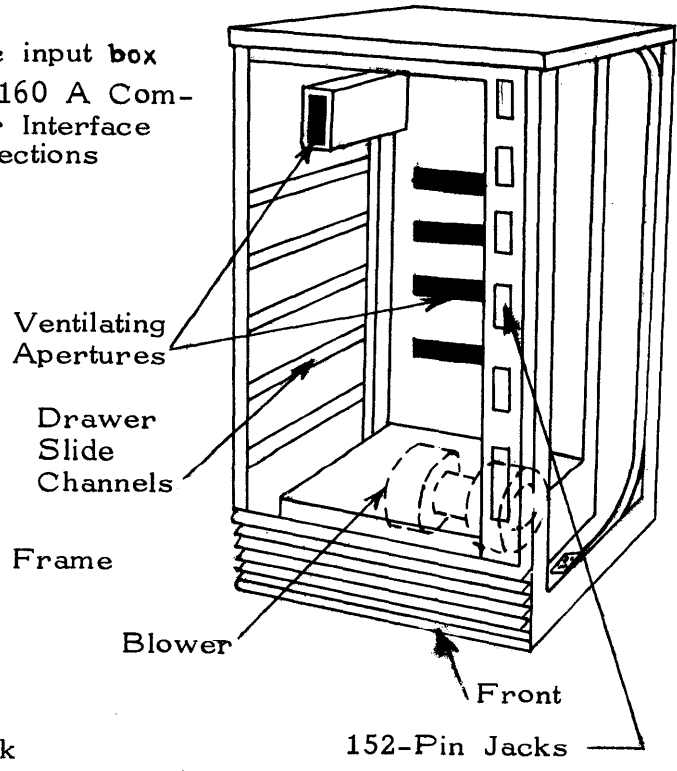
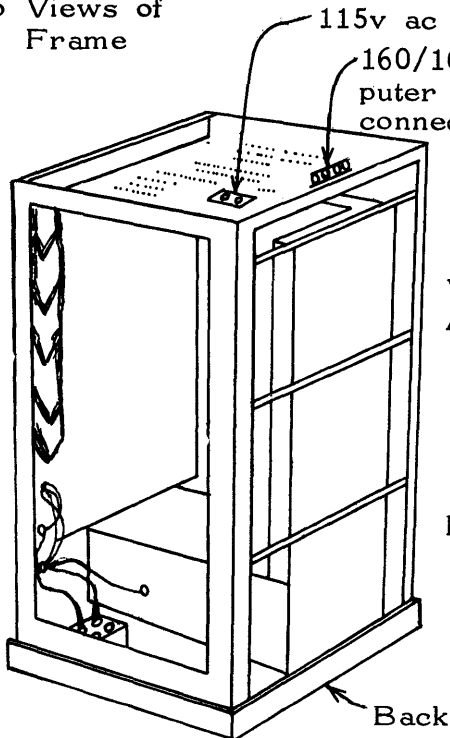

Complete Multiplexer Cabinet

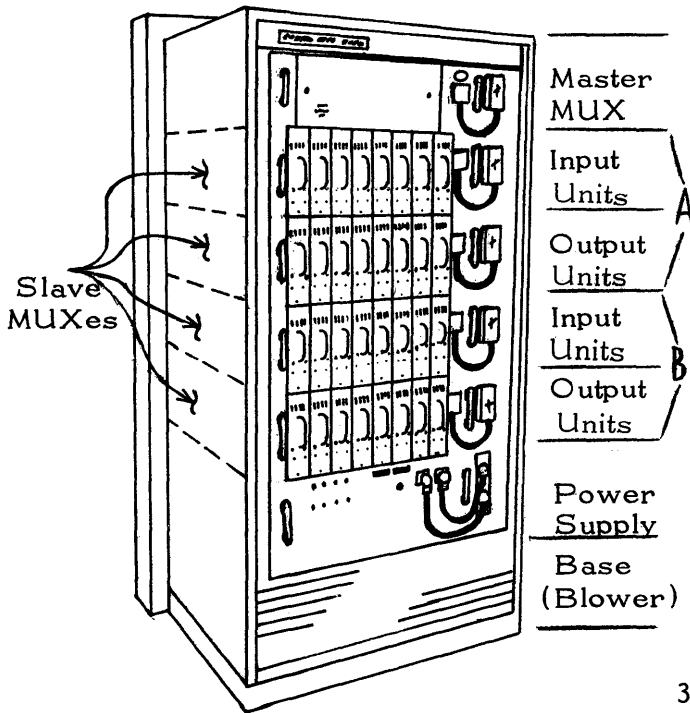

DESCRIPTION

The CONTROL DATA\* 8155 MULTIPLEXER (MUX) cabinet is a complete multiplexer housing which has the following purposes--  
--used for selecting one of up to 16 full-duplex telegraph communications channels and connecting it to the normal input/output channel of the computer.

\* Registered Trademark



- switches up to eight data bits in parallel from each input device into the computer;
- switches up to eight bits in parallel to each output device from the computer;
- imparts four status bits with data;
- provides wiring and connections between the 8165 Master MUX and the slave MUXs;
- provides digital connections to the 160A computer Input/Output.

### Operation

The multiplexer provides a real-time interrupt 30 to the 160A computer approximately every 90 milli-seconds. It should be the only device in the system using the interrupt 30. All MUXs have the real time interrupt circuit, but only one MUX in the switching system is allowed to issue the interrupt 30. When interrupted, the 160A must function select the MUX. The Function Select code will select the MUX and one of its 16 full duplex channels. When the channel has been selected, the 160A must input one 12-bit computer word and check the 4 high-order-bit positions for status. The status will indicate if the channel requires service and the type of service required.

If Character Ready bit 11 is set, a 5 or 8-bit teletypewriter character occupies the 8 low-order bit positions of the 12-bit computer word. If bit 10 is set, the channel is ready to accept an output character. The computer must retrieve the character and present it to the MUX in the 8 low-order bit positions of a computer output word. The status of all channels must be checked after receipt of every 30 level interrupt.

Specifications

Function Select Code - the upper six master bits (unit designator) select a group of four 16-channel multiplexers. The two most significant bits of the function designator select a particular 16-channel master MUX. Each master MUX has up to two full-duplex slave modules. The next most significant bit ( $2^3$ ) designates the group of 8. The three least significant bits designate a particular full-duplex channel from a group of 8 full-duplex channels.

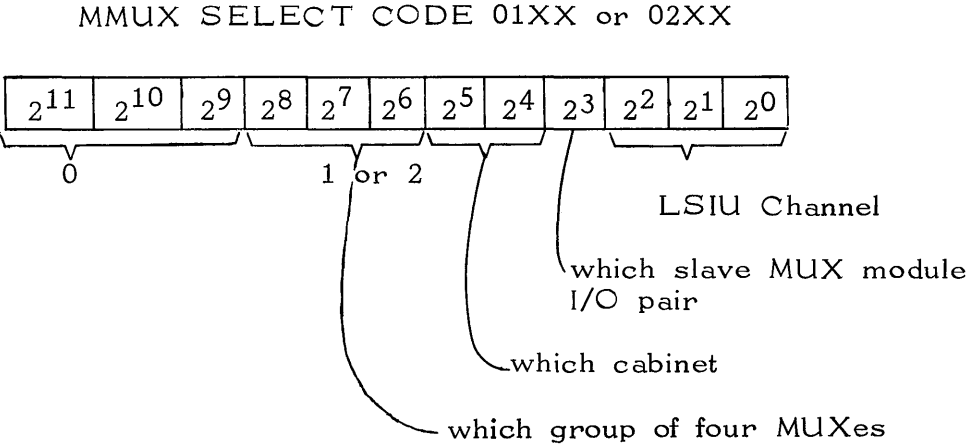

The group of 16 address can be changed by the operator so that any MUX can serve as a spare.

Packaging - The MUX is modular. All modules are pluggable and can be easily patched from one cabinet to another to serve as a spare.

The slave modules are designed to receive the low-speed input or output units (LSIU or LSOU) directly. To replace an input or output unit is a simple substitution. The telegraph circuits are connected to each slave module through a pluggable cable.

The master MUX is connected to the computer's normal channel with Input-Output cables. "Umbilical" cables are used to connect the slave MUX modules and the master MUX module to common cabinet wiring and receptacles.

Fan-in/Fan-out - The system back-up philosophy requires MUXs to be modular and not connected to the normal channel through a common device other than the 8910-A dual computer-transfer unit or equivalent. The degree to which this can be realized is limited because only 5 peripheral devices can be connected to the computer normal channel. To maintain the modular 16 concept without violating the normal channel loading, fan-in/fan-out repeaters are provided in each master MUX.

Multiplexer Word - The MUX word is up to 8 bits of communications data, but 12 bits are provided for control and data transfer together.

Computer Interface -

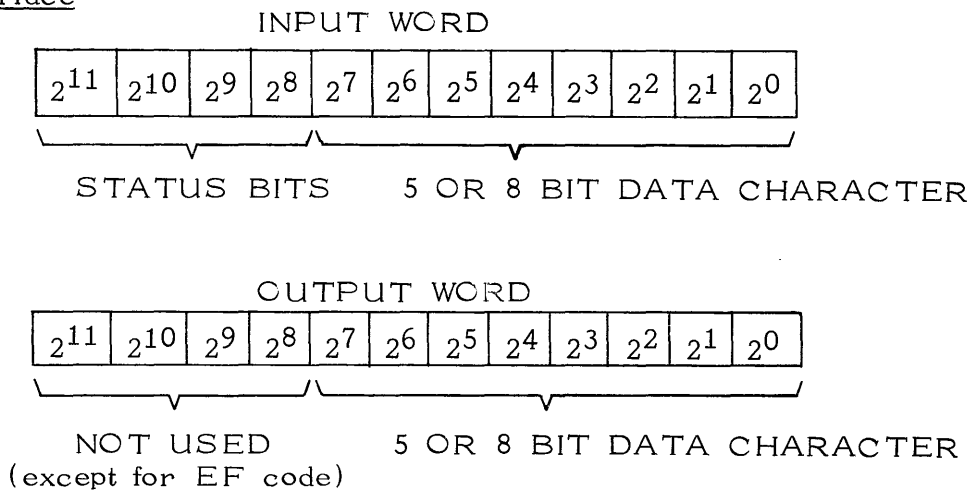

Monitor Computer Application - For this application the monitor input slave MUX will receive CHARACTER LOST signals from low-speed input units in the switcher cabinets. The signals will occupy the data bit positions normally assigned to low-speed input units. Each channel of the monitor MUX can monitor 8 receive circuits connected to the switching computer. One master MUX with two Receive Slave modules can monitor 64 full-duplex teletypewriter circuits.

Connected to the output slave module at three of the LSOU locations are the 8912-Reset Timers. This device has a MUX interface and is packaged similar to an LSOU.

The real-time interrupt of the switcher computer is used in the monitor computer to initiate the monitor computer program that resets the alarm timer and scans all LSIUs for lost characters.

LSIU Status Codes

COMPUTER WORD

BIT 11	10	9	8	- - - - -	0
1					BIT 11 CHARACTER READY
	1				BIT 10 CHARACTER REQUEST
		1			BIT 9 CHARACTER LOST
			1		BIT 8 BREAK/IDLE

EXTERNAL FUNCTION SELECT CODE 01XX AND 02XX  
 FOR ADDRESSING A SPECIFIC LOW-SPEED INPUT/OUTPUT UNIT  
 (LSIU OR LSOU) IN A MULTIPLEXER SYSTEM

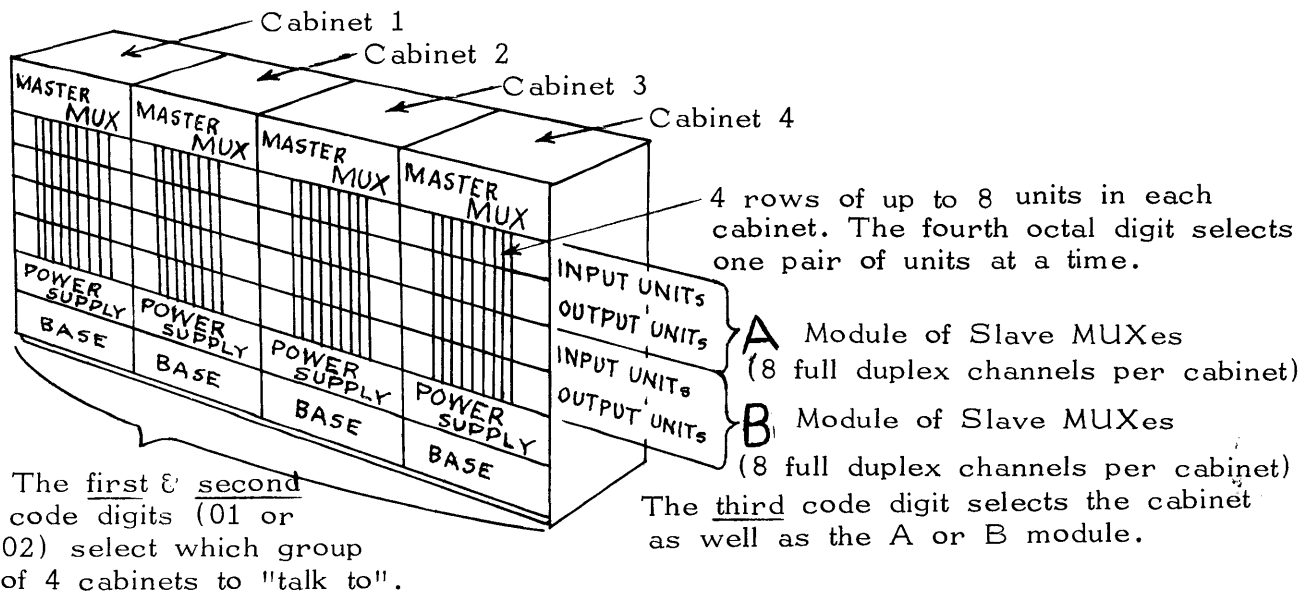

The External Function Select codes 01XX and 02XX are reserved for addressing an eight-cabinet multiplexer system. Each octal digit represents three bits of data. Multiplexer systems can be addressed in groups of four 8155 cabinets.

The first and second digits of the code (01 and 02) direct the computer communication to either of two groups of 8155 cabinets (four cabinets maximum to a group).

The third octal digit chooses not only a cabinet but also a module (A or B) within the cabinet (see sketch). The first two bits select a cabinet (the binary count limit of two bits is four). The third bit selects the A or B module.

The fourth octal digit of this code selects one of eight pairs (one input and one output) of LS I/O units by octal conversion to numbers 0 through 7.

The computer scans each pair of LS I/O units in a cycle. If a character is ready for input or output at any LS I/O unit, the computer can serve that location by receiving and/or sending a data character, and then continues its scanning cycle.

To show the exact selection, divide the octal code into its binary equivalent as shown here:

Octal	0	1 (or 2)	X	X																																	
	$(2^{11} 2^{10} 2^9)$	$(2^8 2^7 2^3)$	$(2^5 2^4 2^3)$	$(2^2 2^1 2^0)$ LS I/O Unit No.																																	
Binary	000	001 (or 010)		0 0 0 — 0																																	
	Multiplexer System	Group of 4 Cabinets																																			
		Cabinet 1	<table style="display: inline-table; vertical-align: middle;"> <tr><td rowspan="2" style="font-size: 2em;">{</td><td>0</td><td>0</td><td>0</td></tr> <tr><td>0</td><td>0</td><td>1</td></tr> </table>	{	0	0	0	0	0	1	<table style="display: inline-table; vertical-align: middle;"> <tr><td rowspan="2" style="font-size: 2em;">{</td><td>0</td><td>0</td><td>1</td></tr> <tr><td>0</td><td>1</td><td>0</td></tr> </table>	{	0	0	1	0	1	0	<table style="display: inline-table; vertical-align: middle;"> <tr><td rowspan="2" style="font-size: 2em;">{</td><td>0</td><td>0</td><td>1</td></tr> <tr><td>0</td><td>1</td><td>0</td></tr> </table>	{	0	0	1	0	1	0	<table style="display: inline-table; vertical-align: middle;"> <tr><td>0</td><td>0</td><td>1</td><td>—</td><td>1</td></tr> <tr><td>0</td><td>1</td><td>0</td><td>—</td><td>2</td></tr> </table>	0	0	1	—	1	0	1	0	—	2
{	0	0	0																																		
	0	0	1																																		
{	0	0	1																																		
	0	1	0																																		
{	0	0	1																																		
	0	1	0																																		
0	0	1	—	1																																	
0	1	0	—	2																																	
		Cabinet 2	<table style="display: inline-table; vertical-align: middle;"> <tr><td rowspan="2" style="font-size: 2em;">{</td><td>0</td><td>1</td><td>0</td></tr> <tr><td>0</td><td>1</td><td>1</td></tr> </table>	{	0	1	0	0	1	1	<table style="display: inline-table; vertical-align: middle;"> <tr><td rowspan="2" style="font-size: 2em;">{</td><td>0</td><td>1</td><td>0</td></tr> <tr><td>0</td><td>1</td><td>1</td></tr> </table>	{	0	1	0	0	1	1	<table style="display: inline-table; vertical-align: middle;"> <tr><td rowspan="2" style="font-size: 2em;">{</td><td>0</td><td>1</td><td>1</td></tr> <tr><td>1</td><td>0</td><td>0</td></tr> </table>	{	0	1	1	1	0	0	<table style="display: inline-table; vertical-align: middle;"> <tr><td>0</td><td>1</td><td>1</td><td>—</td><td>3</td></tr> <tr><td>1</td><td>0</td><td>0</td><td>—</td><td>4</td></tr> </table>	0	1	1	—	3	1	0	0	—	4
{	0	1	0																																		
	0	1	1																																		
{	0	1	0																																		
	0	1	1																																		
{	0	1	1																																		
	1	0	0																																		
0	1	1	—	3																																	
1	0	0	—	4																																	
		Cabinet 3	<table style="display: inline-table; vertical-align: middle;"> <tr><td rowspan="2" style="font-size: 2em;">{</td><td>1</td><td>0</td><td>0</td></tr> <tr><td>1</td><td>0</td><td>1</td></tr> </table>	{	1	0	0	1	0	1	<table style="display: inline-table; vertical-align: middle;"> <tr><td rowspan="2" style="font-size: 2em;">{</td><td>1</td><td>0</td><td>0</td></tr> <tr><td>1</td><td>0</td><td>1</td></tr> </table>	{	1	0	0	1	0	1	<table style="display: inline-table; vertical-align: middle;"> <tr><td rowspan="2" style="font-size: 2em;">{</td><td>1</td><td>0</td><td>1</td></tr> <tr><td>1</td><td>1</td><td>0</td></tr> </table>	{	1	0	1	1	1	0	<table style="display: inline-table; vertical-align: middle;"> <tr><td>1</td><td>0</td><td>1</td><td>—</td><td>5</td></tr> <tr><td>1</td><td>1</td><td>0</td><td>—</td><td>6</td></tr> </table>	1	0	1	—	5	1	1	0	—	6
{	1	0	0																																		
	1	0	1																																		
{	1	0	0																																		
	1	0	1																																		
{	1	0	1																																		
	1	1	0																																		
1	0	1	—	5																																	
1	1	0	—	6																																	
		Cabinet 4	<table style="display: inline-table; vertical-align: middle;"> <tr><td rowspan="2" style="font-size: 2em;">{</td><td>1</td><td>1</td><td>0</td></tr> <tr><td>1</td><td>1</td><td>1</td></tr> </table>	{	1	1	0	1	1	1	<table style="display: inline-table; vertical-align: middle;"> <tr><td rowspan="2" style="font-size: 2em;">{</td><td>1</td><td>1</td><td>0</td></tr> <tr><td>1</td><td>1</td><td>1</td></tr> </table>	{	1	1	0	1	1	1	<table style="display: inline-table; vertical-align: middle;"> <tr><td rowspan="2" style="font-size: 2em;">{</td><td>1</td><td>1</td><td>0</td></tr> <tr><td>1</td><td>1</td><td>1</td></tr> </table>	{	1	1	0	1	1	1	<table style="display: inline-table; vertical-align: middle;"> <tr><td>1</td><td>1</td><td>0</td><td>—</td><td>7</td></tr> </table>	1	1	0	—	7					
{	1	1	0																																		
	1	1	1																																		
{	1	1	0																																		
	1	1	1																																		
{	1	1	0																																		
	1	1	1																																		
1	1	0	—	7																																	

Example: The computer has a character ready to send to a teletypewriter way station which is connected to LSOU No. 5 in module B in the second cabinet. What is the EF code to address this LSOU?

Solution: The first and second octal digits (01) are given. The bits of the third octal digit (01XX) are "01" for the second cabinet and "1" for module B. The fourth octal digit is composed of bits 101 representing unit No. 5.

This gives us the following answer for our EF select code:

Binary	000 001 011 101
Octal	0135 = EF Select Code

Input or Output Unit Selection

Actually, the computer selects both the low-speed input and output units a pair at a time. If the computer's Information Ready signal AND gates with the LSOU's Character Request, the output unit is connected.

On the other hand if the computer's Input Request signal AND gates with the LSIU's Character Ready signal, the Input Unit is connected.

The Decoder Plug is a 24-pin twist-lock cylinder which is wired to decode the first three octal digits of the EF Select Code. It plugs into

the panel of each 8165 Master Multiplexer. It is wired to select the correct cabinet and module, for example (010X.  
011X)



The fourth digit is decoded in the internal logic of the multiplexer to select one of eight pairs of LS I/O units.





**CONTROL DATA  
8165 MASTER  
MULTIPLEXER**

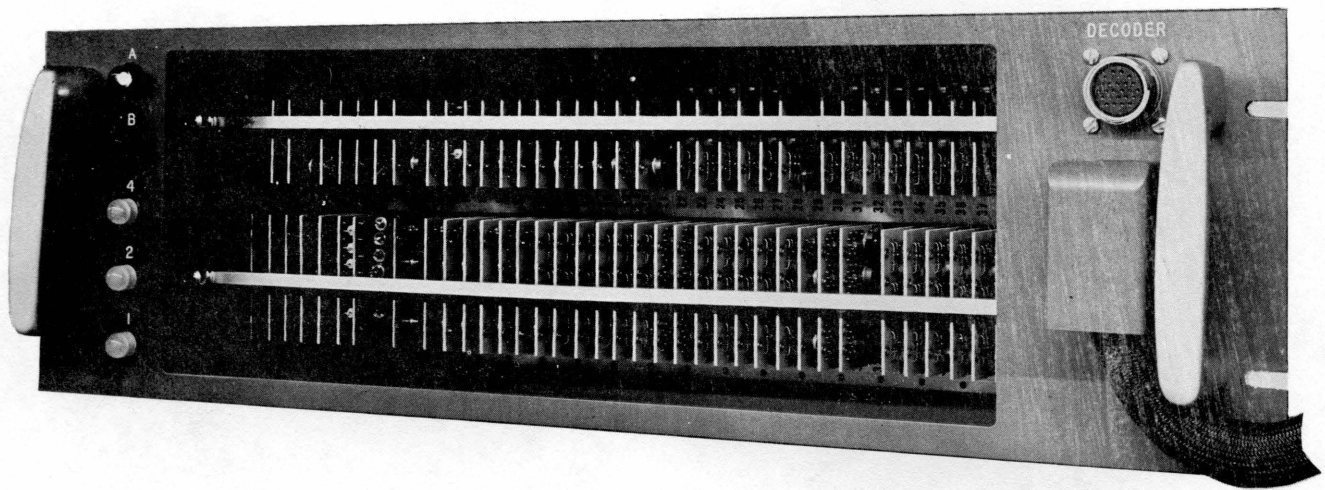

CONTROL DATA  
8165  
MASTER MULTIPLEXER (MMUX)  
(Front cover plate, decoder plug, and I/O plug not shown)

CONTROL DATA\*8165 MASTER MULTIPLEXER (MMUX)

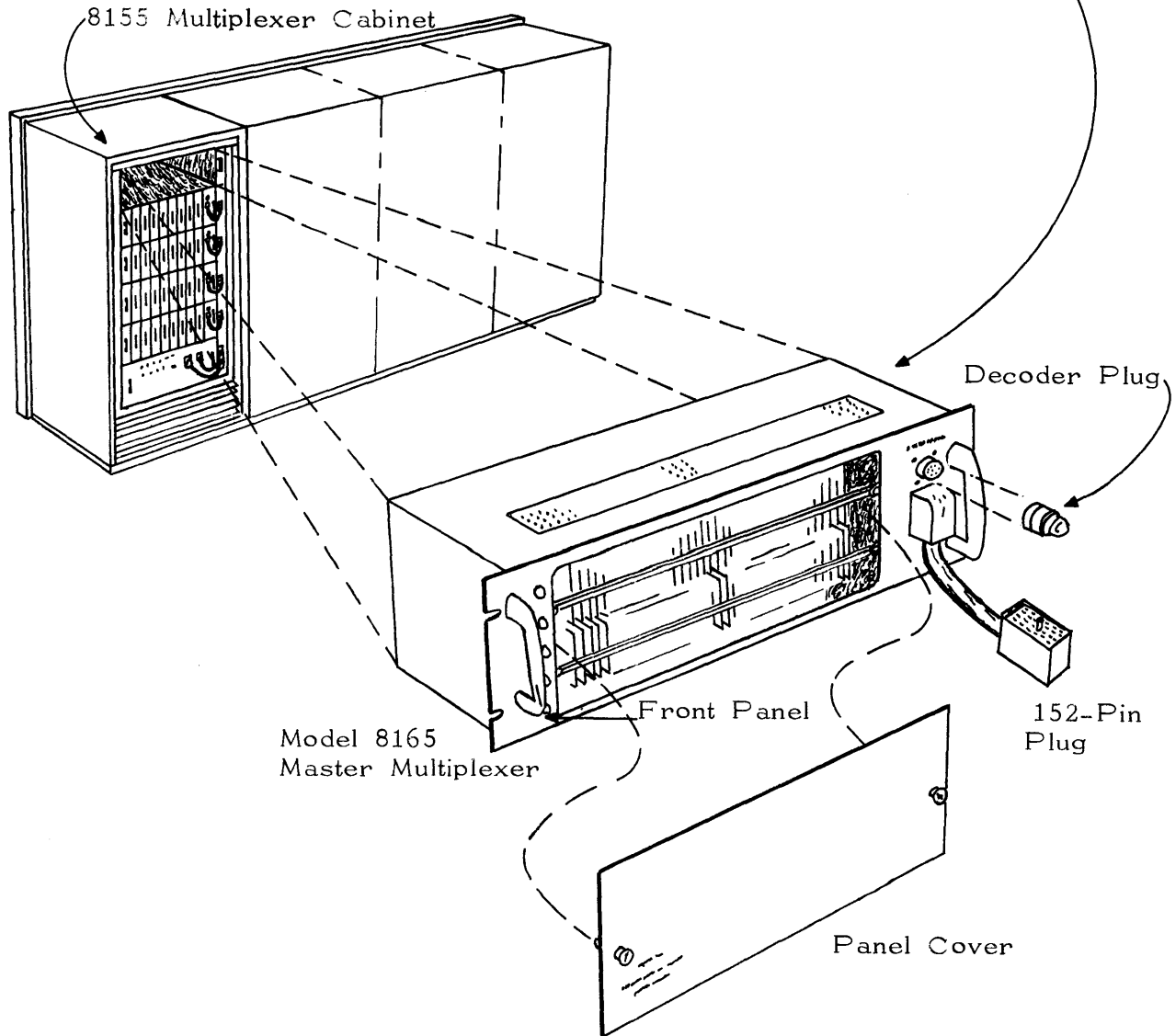

DESCRIPTION

The 8165 Master Multiplexer is a removable module of the 8155-A Multiplexer cabinet. It is an external function select decoder, interrupter, and provides the following results --

---

\* Registered Trademark

The input logic of the 8165 has a threefold purpose--

--It is a channel for parallel-bit transmission of each input character from an 8508 Low-Speed Input Unit to the 160-A switcher computer. When alarm status signals such as Character Lost or Break/Idle are generated in an input unit, they pass through the MMUX to the computer.

--Character Ready When an input unit sends a Character Ready bit through the 8165 to the computer, the computer should return an Input Request via the 8165 to the Input Unit.

--The Input Request signal has two major purposes. First it enables the input Select Function which is decoded in the output section of the 8165. This allows a character to leave a LSIU and enter the computer. Secondly, the Input Request signal undergoes an 18-usec delay and then produces an Input Ready signal. This allows time for the computer input data lines to stabilize. The Input Ready drops when the Input Request is dropped by the computer.

### 160-A Computer Input/Output Operation as it Affects the 8165 MMUX

## INPUT/OUTPUT SECTION

The input/output section of the computer provides the methods for data exchange and for control of information transmission between the computer, the various external equipments, and the reader and punch.

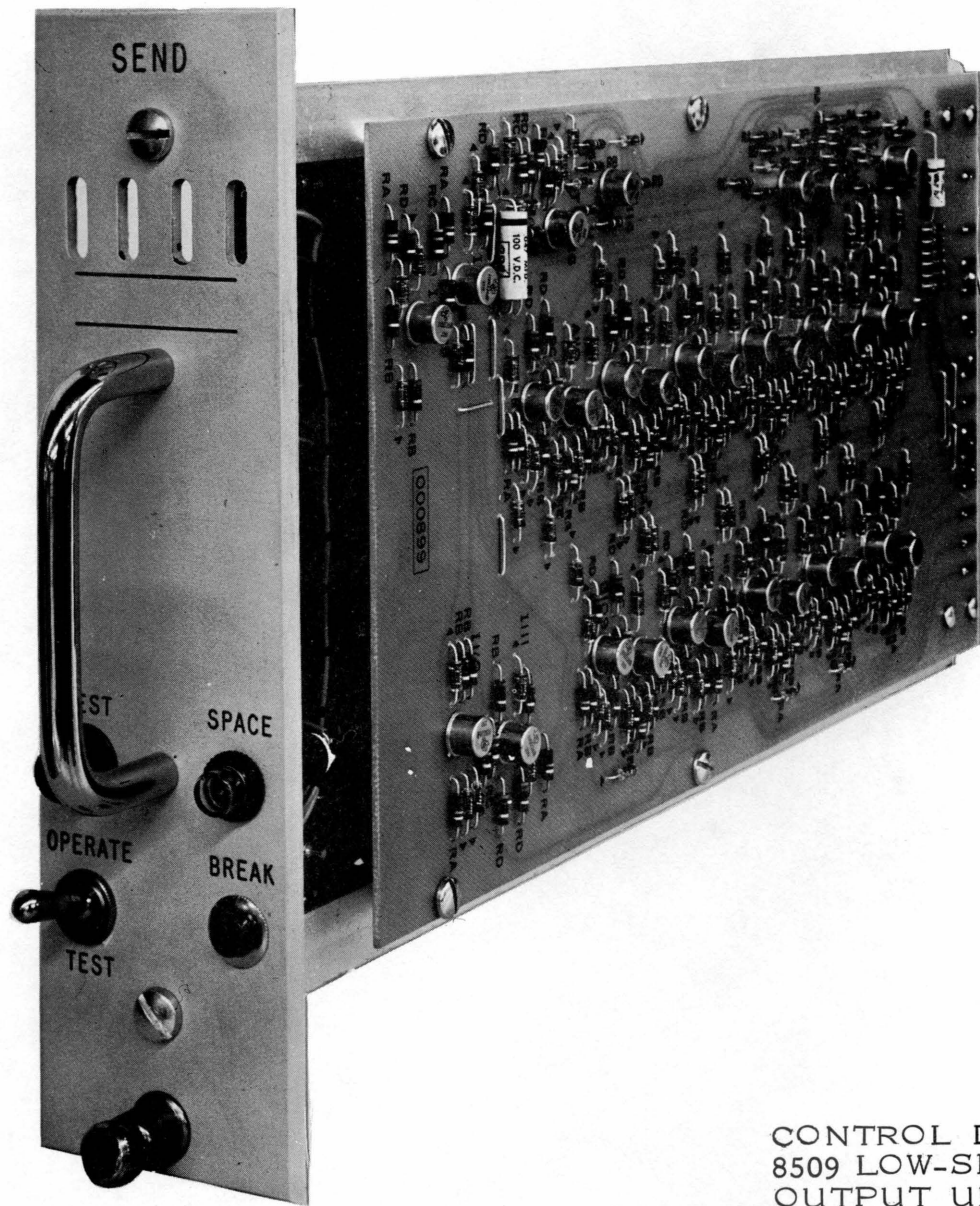

CONTROL DATA  
8509 LOW-SPEED  
OUTPUT UNIT  
(LSOU)

## CONTROL DATA 8509 LOW-SPEED OUTPUT UNIT (LSOU)

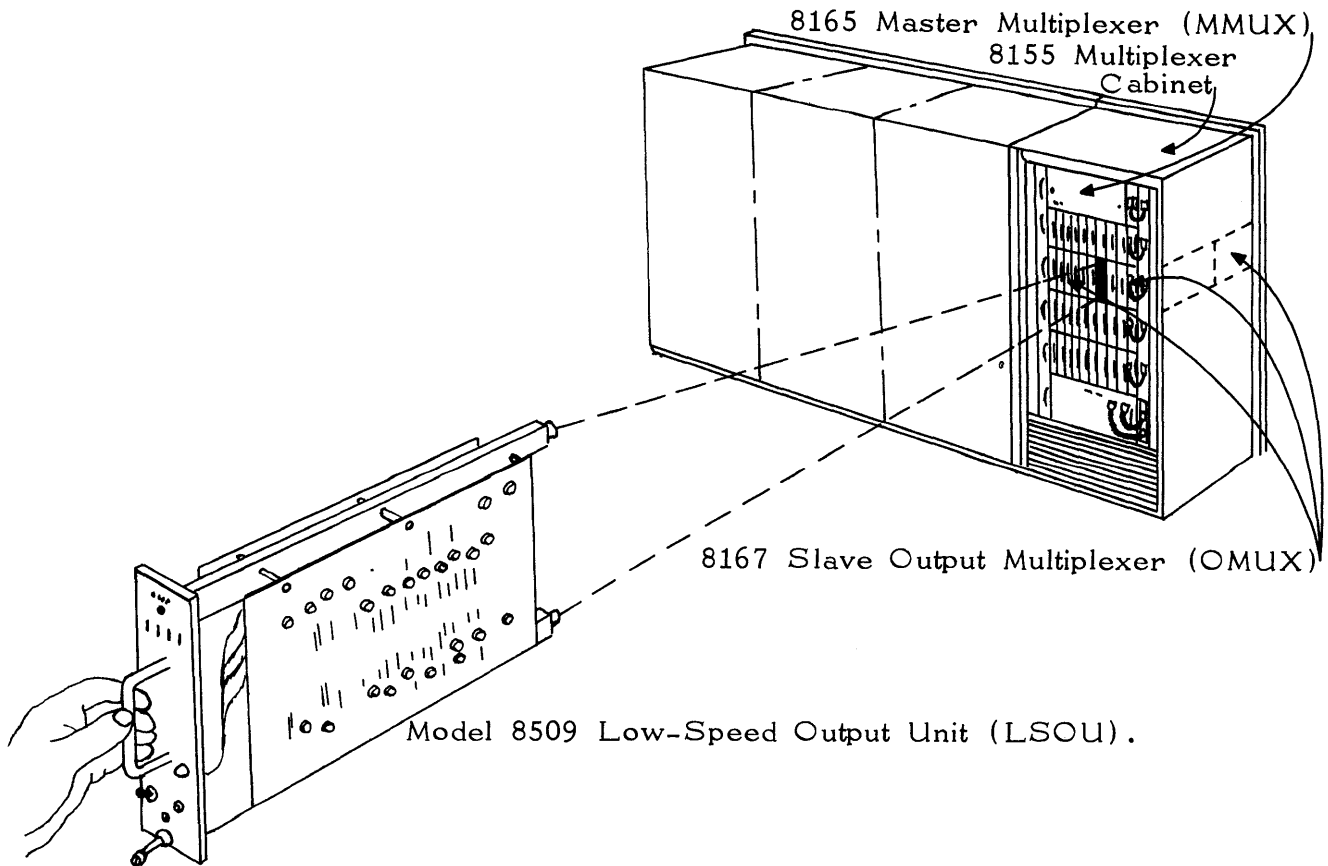

### DESCRIPTION

The CONTROL DATA\*8509 Low-Speed Output Unit (LSOU) is a signal converter interposed between one output point on a CONTROL DATA 8167 Output Slave Multiplexer and a Teletypewriter Communications Channel. The LSOU receives parallel bit characters from the Multiplexer. By means of a clock and counter, it sends the bits serially to the telegraph circuit in the 7.5 unit start-stop teletypewriter code.

---

\* Registered Trademark

LSOU Panel

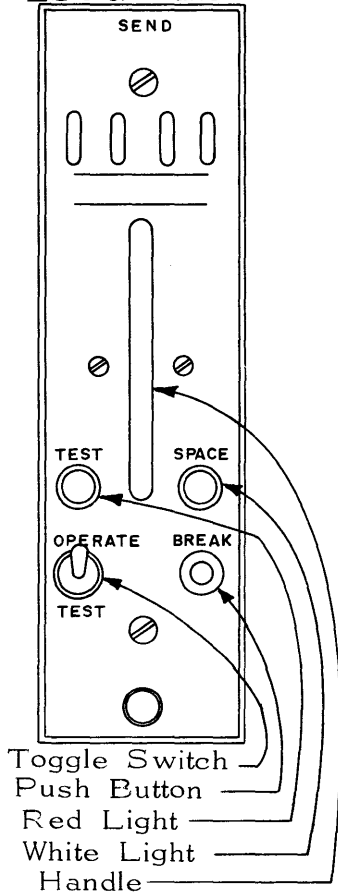

Panel:

The Panel of the 8509 (LSOU) is a control board which mounts flush against the front surface of the 8167 OMUX. It contains the following labeled lights and switches:

SPACE Light (white): This light flickers while the LSOU is sending a message. It lights every time there is a break or space pulse in the teletypewriter communications line.

TEST Light (red): This light turns on when the "Operate-Test" toggle switch is down in the "test" position. This warns the operator that the LSOU is inoperative.

OPERATE-TEST Toggle Switch: This switch must be up in the "Operate" position during the

normal sending operation of the LSOU. The down or "Test" position of the switch turns on the red "test panel light. It sets the clock control which in turn starts the clock. This switch can be used during maintenance checks and tests.

BREAK Push-Button Switch: When this button is depressed it actuates relay R<sup>100</sup> which opens the teletypewriter circuit. The teletypewriter line voltage lights the SPACE lamp at a value of 90 volts or greater.



Logic Cards

Each LSOU fits into an 8167 OMUX like one of eight books on a shelf. The LSOU consists of three printed circuit cards.

Card A contains A (Transfer) Register A and (Holding) Register B as well as the status code flip flop.

Card B contains the character serializer.

Card C contains the clock and counter.

The two outer cards are hinged at the rear for easy access.

Since the 8509 LSOU is a pluggable unit, all logic signals, power, and telegraph circuits enter through the 22-pin connector on the rear of the LSOU.

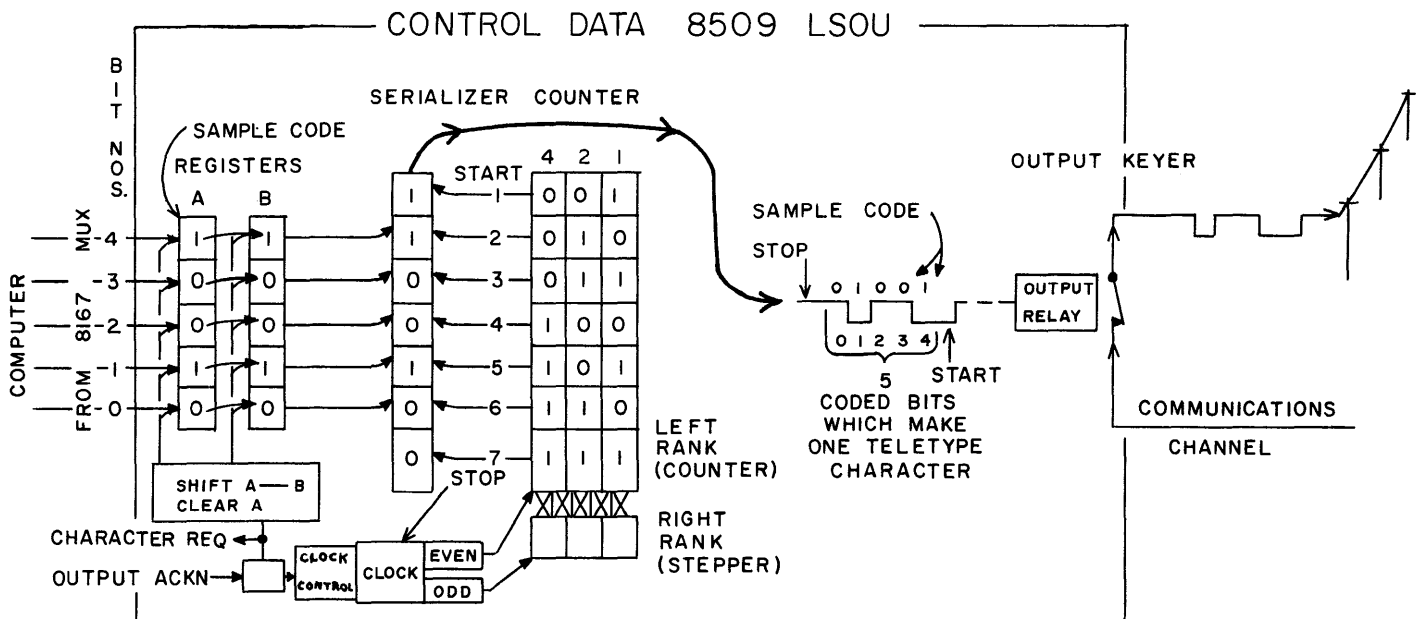

Summary of Characteristics

The LSOU performs as follows -- (when it is selected to send a character):

--It receives five parallel simultaneous data bits.

- Simultaneously it receives an OUTPUT ACKNOWLEDGE signal. This enables the five-bit character to enter register A.
  - It shifts the character from Register A to B and clears Register A.
  - It requests the next five-bit character by generating a Character Request signal.
  - It starts the multivibrator clock.
  - The clock actuates the counter.
  - The counter sends one bit at a time in sequence and adds start and stop units.
  - The serializer regulates the consecutive order of the bits.
  - The Output Keyer puts the 7.5 unit code on the communications line.
- Each character in a 100 wpm (for example) system has a duration of 100 milliseconds, including start and stop pulses.

### General Description

An LSOU is an electronic parallel-to-serial converter that is compatible with teletypewriter communication channels, codes, and speeds. This 8509 LSOU accepts one five-bit character at a time by way of the multiplexer. Each character is stored in a register before it is "clocked out". A series of pulses is produced containing the data bits and the start and stop pulses required by the teletypewriter circuit driven by the LSOU. An 8509 LSOU can generate 7.42 or 7.5-unit characters with five information pulses. The clock is adjustable to provide output rates within the range of 60 to 100 words per minute.

An internal single-character register stores one five-bit character in addition to the character undergoing parallel to serial conversions. For this reason, the

Switcher has the time of one character cycle to respond to a Character Request from the LSOU in order to maintain the maximum output rate.

An LSOU generates only one status code -- Character Request. When the Switcher responds with Information Ready, the Multiplexer enables the data character and Output Acknowledge to be sent to the LSOU. This event causes the Request to drop and the serializing function to start in the LSOU. If no character is transferred with the acknowledgement, a blank character is generated and sent by the LSOU. Failure of the Switcher to acknowledge a Request merely extends the stop pulse.

#### LOGIC DIAGRAM (See Logic Diagrams, Drawing No. 360149)

When the LSOU is not sending data the relay  $R^{100}$  is de-energized. The Telegraph communication channel is a closed circuit. A marking line current passes through the circuit. This holds true until the start pulse of a character reaches the relay  $R^{100}$ .

When a five-bit character passes through the LSOU, the five bits reach the LSOU in parallel in external voltage levels ("1" = 0.5v, "0" = -16v). Each bit passes through an M card and is converted to internal voltage levels ("1" = -3.5v, "0" = nominal  $\emptyset$ v).

#### Register Control

The Register Control has three main purposes --

--To shift the contents of Register A into Register B at the same time that the clock starts.

--To clear A 25 usec after "A" has been shifted to B.

--To enable the next Character Request to be sent to the 8165 MUX.

Shift "A" to B When the clock is set, it sends a 19-usec "1" pulse to the register control. This pulse shifts the contents of Register A to Register B. The five bits in B are then ready to be withdrawn in sequence by the serializer circuits.

Clear A After allowing 25 usec for the completion of the shift "A" to B signal, the register control sends a pulse which enables the clearing of Register A.

#### Status Code (Character Request)

The signal which cleared A also cleared the Output Acknowledge Flip Flop. After A is cleared the Output Acknowledge flip flop is enabled to send a character request through the 8165 MMUX.

#### Output Acknowledge Signal

Whenever an 8509 LSOU receives a 5-bit character from the switcher computer, it also receives an OUTPUT ACKNOWLEDGE signal. The Output Acknowledge is a logic "1" signal which has the following functions within the LSOU.

--It enables the data character to enter Register A.

--It starts the clock by setting a flip flop A<sup>110</sup>/A<sup>111</sup> which sends a "1" to the clock control K<sup>100</sup>/K<sup>101</sup>.

--After Register A sends a character to Register B and is cleared, the Output Acknowledge signal return a Character Request signal through the multiplexer.

Clock Control (Starts and stops the Clock)

With the clock stopped between data characters, the outputs of Inverter 1<sup>104</sup> and odd clock are "1" 's. These "1" 's are gated with the "1" from A<sup>111</sup> to set the Clock Control Flip Flop K<sup>100</sup>/K101.

When the clock control is set it sends out a "1" signal on four lines --

- The first "1" enables the clock to cycle on the even pulse and is regulated by an adjustable card. The delay is set 1/2 a bit pulse duration.
- The second and third "1" 's form a 19 usec pulse which starts the clock.
- The fourth "1" enables a 19 usec pulse to enter the Register Control (shift (A) B, Clear A).

Clock

The clock of the LSOU is a free running multivibrator. As it cycles it sends out odd and even pulses. When the clock is "set" it sends a short pulse ("1") out through the Even Clock circuit. When the Clock is cleared it sends a short pulse ("1") to the Odd Clock circuit. The clock produces underlapped odd and even pulses. The clock cycles eight times for each character.

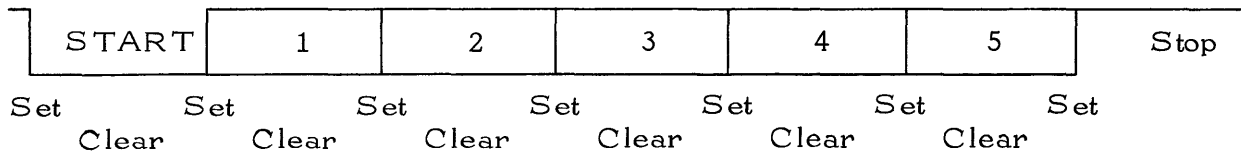

These pulses act to set and shift the counter flip flops and to clear the clock control after the last data bit. The clock control in turn stops the clock.

Even Clock and Odd Clock

The alternating pulses from the Odd and Even clocks feed into the Counter. The Even Clock enables the left rank flip flops of the Counter to be set or cleared if other AND conditions are met. The Odd Clock transfers the count from left to right rank flip flops. The Even and Odd clocks send pulses alternately to the left and right ranks of the counter.

COUNTER

The left rank of the Counter counts in binary. The right rank stores the count and gates the advance. The odd/even pulses alternate back and forth between the left and right ranks advancing the count by one for each cycle. The counter counts up to eight. The eighth count clears the Clock Control which in turn clears or turns off the clock.

SERIALIZER

The Counter is part of the Serializer circuit. The Counter provides binary count codes for the serializer. Through AND GATES the codes enable six gates (5 bits and a start pulse) one at a time in the serializer to provide the following character format:

<u>Counter Count</u>	<u>Serializer Connection</u>	<u>Data</u>
1	1	"1" (START)
2	2	Bit 4 binary code ("1" or "0")
3	3	Bit 3 binary code ("1" or "0")
4	4	Bit 2 binary code ("1" or "0")
5	5	Bit 1 binary code ("1" or "0")
6	6	Bit 0 binary code ("1" or "0")
7.5	No connection	"0" (STOP)

OUTPUT KEYER

Seven-and-a-half unit pulses are sent to output Relay R<sup>100</sup>. An LSOU "1" signal actuates the Output Relay and breaks the line current. Through the Output Keyer the LSOU sends out in serial form and in teletypewriter 7.5 - unit code the original five-bit character.

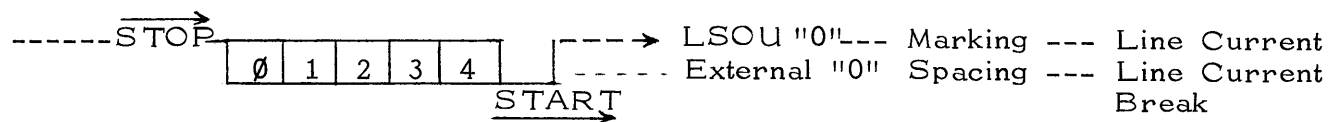

Four cables, two input and two output, link the external equipment to the computer. All information from the externally located peripheral equipments must enter or leave the computer through one of these cables. The paper tape reader and punch, being integral to the computer console cabinet, do not connect to the I/O cables.

Information passes between the computer and the external equipment as a block of information at a word-by-word rate or as a single word input or output. The speed of the particular equipment in communication with the computer determines the data exchange rate.

#### INTERRUPT

An interrupt signal jumps the computer main program and initiates an interrupt routine. At the completion of the interrupt subroutine the main program may be resumed. Each interrupt 30 signal transfers computer control to a distinct location in memory (refer to "Execution" on page 9).

To use the interrupt feature it is necessary that every external function command must be followed by a CIL (Clear Interrupt Lockout) command, but not until the completion of any I/O sequence related to that EF command.

#### RECOGNITION

The interrupt is recognized at the start of the read next instruction cycle when one of the Interrupt FFs is set. The resultant output of F574 sets up the D to B to C sequence by forcing the Function register to 40.

**CONTROL DATA**  
**8901-B TIME OF DAY**  
**CLOCK**



### Interrupt 30 Recognition

160-A Interrupt FFs are activated by an internal 8165 MMUX clock. The routine must branch to a subroutine to handle interrupt. The interrupt signal is removed from the line by the external equipment.

### EXECUTION

During the execution portion of the interrupt 30 circuit, the computer stores the contents of P at location 0030, and then takes its next instruction from 0031 to enter the subroutine.

160-A COMPUTER INPUT AND OUTPUT CABLE LINES

INPUT CABLE LINES	
Input Data and Input Status (12 lines)	Dual purpose: 1) As data lines, they hold equipment input register contents which the computer may sample. 2) As input status lines, they indicate equipment's response to status request interrogation.
Input Ready (1 line)	Indicates that the external equipment contains information which the computer may sample.
Input Request (1 line)	Indicates to external equipment that computer desires an input word. This line is turned off by input ready.
Input Disconnect (1 line)	Indicates to computer that input device has no more data to deliver. Computer is then free to resume main program with no further delay. (Generally the input instruction establishes a storage field block of greater capacity than the anticipated input information block.)

OUTPUT CABLE LINES	
Output Data and Output Function (12 lines)	Continuously monitored by all equipment. Dual purpose: 1) As output data lines they hold output word which the external device may sample. 2) As output function lines they carry external function (EF) codes to select or sense a condition within the equipment. Function ready alerts the equipment to sample EF code.
Function Ready (1 line)	Accompanies EF code; turned on by instruction 75 and causes the equipment to examine EF code. It is turned off by an output resume from the external equipment.
Information Ready (1 line)	This signal accompanies the output data word from the computer and is turned on when the computer has a word of information ready for the external equipment. It is turned off by an output resume from the equipment.
Output Resume (1 line)	This signal is turned on when the external device has accepted the output word or EF code.
Interrupt 30 (1 line)	If no Interrupt Lockout, store P at address (d) 0030 and obtain next instruction from address (r) 0031.

CONTROL DATA 160-A Computer Input/Output Communication with Multiplexer System

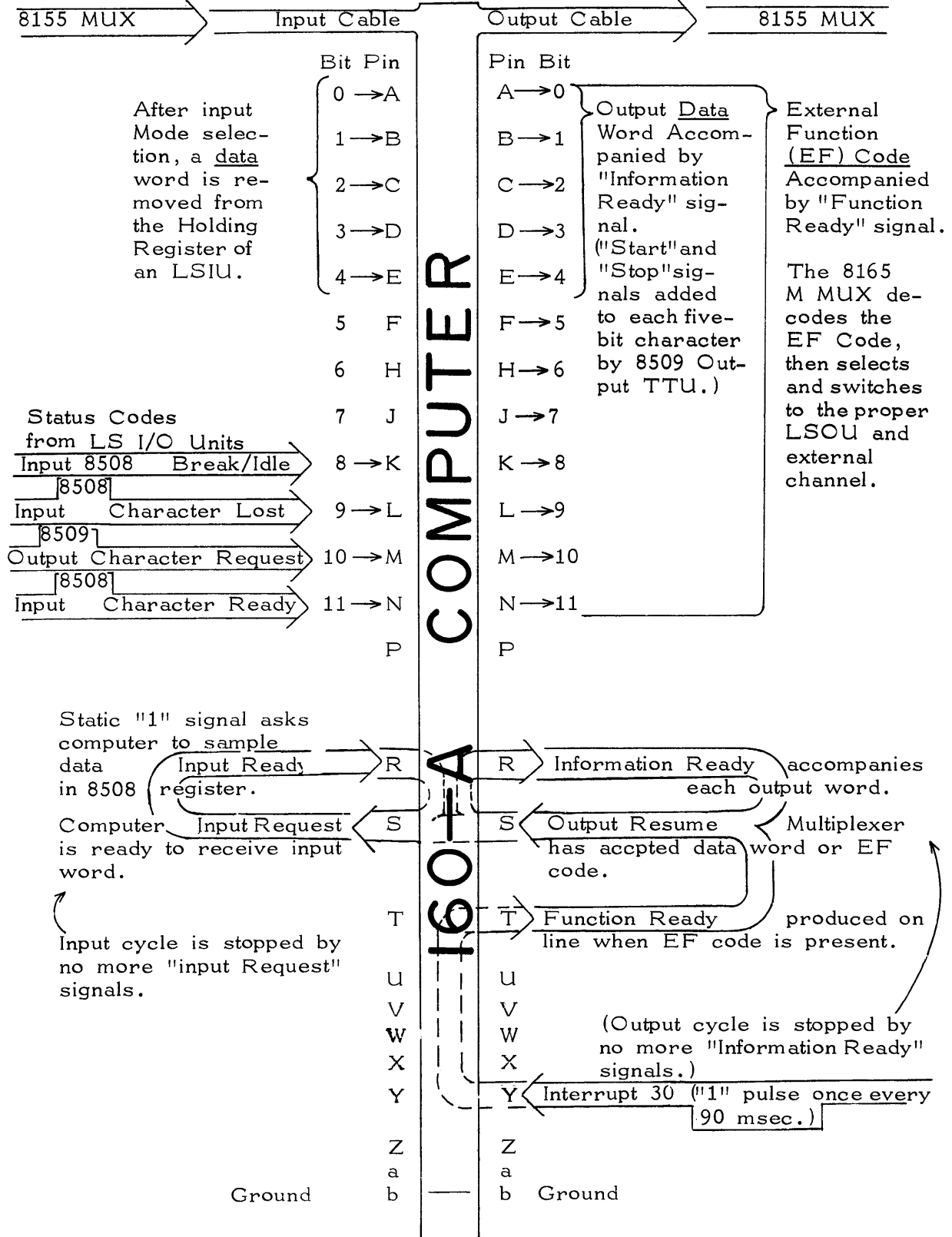



--The 8165 initiates the interrupt 30 signal which periodically asks the computer to scan all channels for incoming or outgoing characters.

--It decodes the computer's EF coded address and selects the proper slave MUX module pair (A or B) to receive or send a character. It sends the LS I/O Unit select code to the slave MUXs for actually selecting each I/O Unit.

--It provides an extension to the normal I/O cables of the 160-A Computer by means of amplifier cards.

--It sends a data character along with an Output Acknowledge signal to the selected 8167 OMUX and the selected output unit.

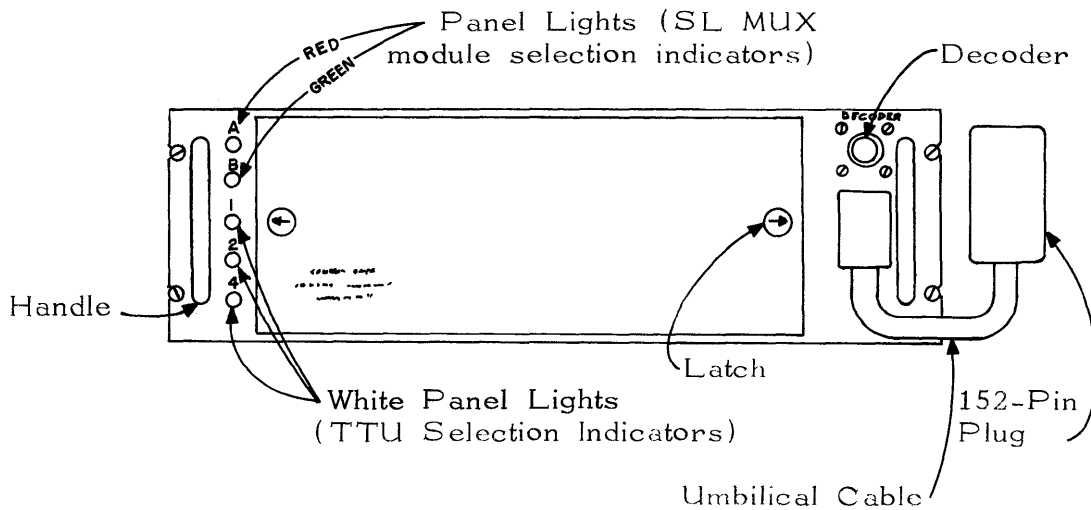

### Panel

The panel of the 8165 serves as a display board for the module and LS I/O Unit select decoders, for the decoder plug, and as an outlet for the I/O cable which connects to the 8155 cabinet. A removable front plate permits access to logic cards.

**CONTROL DATA  
8166 INPUT SLAVE  
MULTIPLEXER**

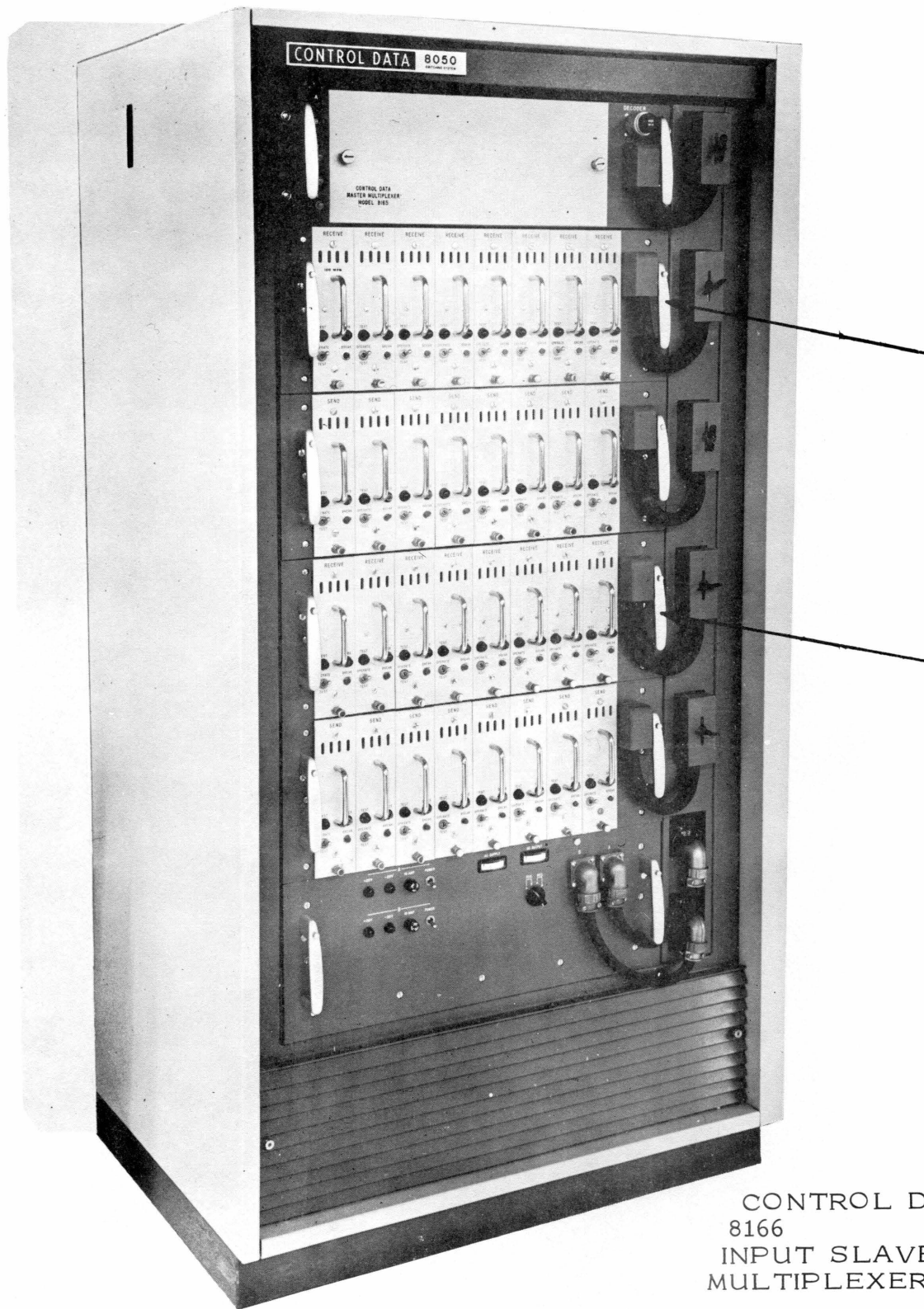

CONTROL DATA  
8166  
INPUT SLAVE  
MULTIPLEXER

CONTROL DATA 8166 INPUT SLAVE MULTIPLEXER (SL MUX)

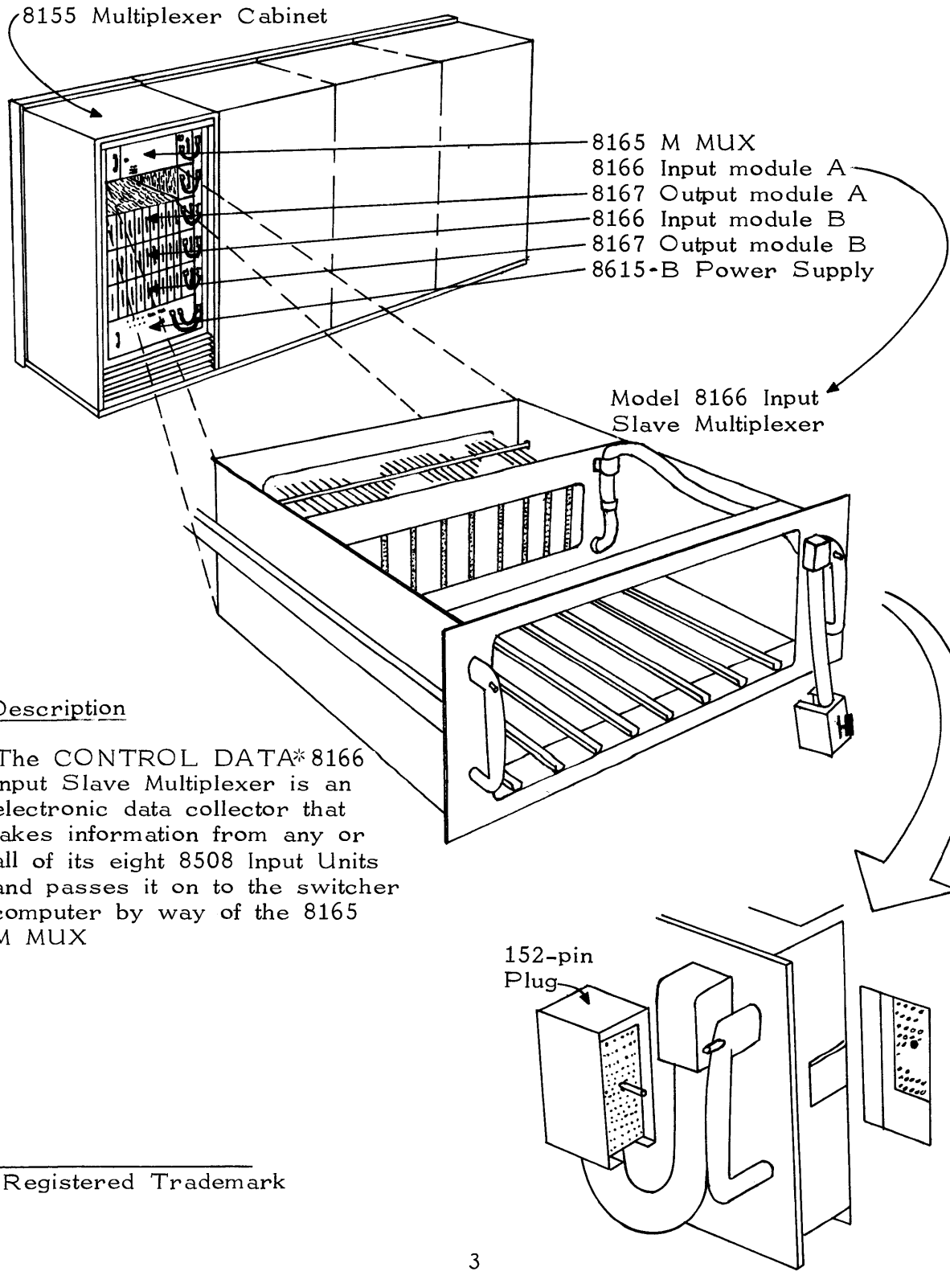

Description

The CONTROL DATA\* 8166 Input Slave Multiplexer is an electronic data collector that takes information from any or all of its eight 8508 Input Units and passes it on to the switcher computer by way of the 8165 M MUX

\* Registered Trademark



### Physical Description

The 8166 is built in the form of a drawer which fits into the 8155 cabinet. The entire 8166 module slides out on telescoping channels. It locks in either the extended or the closed position. Before the "drawer" can be opened the 152-pin plug must be disconnected, and the release buttons on the two pull handles must be depressed. The plug is disconnected simply by unscrewing the wing screw until it is free, and pulling the plug out.

Logic Cards The back part of the module contains two rows of logic cards including the eight 22-conductor receptacles for the Low-Speed Input Units.

LSIUs Eight 8508 Low-Speed Input Units (LSIU) slide into channels in the front of the 8166 like books on a shelf. When the LSIUs are pushed all the way in they mate with the matching receptacles. The LSIUs are locked in with a captive knurled thumb screw.

Status Codes There are four status bits which enter the 8166 from its LSIUs:

CHARACTER READY  
CHARACTER LOST  
BREAK/IDLE

Each status bit is fanned in from eight LSIUs to a single signal line. The fan-in takes place in the 8166 SL MUX. An LSIU can send a status signal only when it is polled with an Input Request.

CHARACTER READY is a "1" signal which accompanies a parallel bit character from an LSIU. The switcher computer selects each LSIU by sending EF codes. When it enables an LSIU which has a Character Ready it receives the signal on Bit 11 and accepts the Character.

INPUT ACKNOWLEDGE is a short pulse which is generated in the 8166 6 usec after the computer accepts the character. The Input Acknowledge signal is sent to the selected LSIU to clear the Character Ready, Character Lost, and Break status flip flops.

CHARACTER LOST is a "1" signal sent from a selected LSIU through the 8166 fan-in if the computer fails to accept a character from the LSIU before the next character arrives. The Character Lost signal is sent not only to the computer but also to an assigned bit position in an LSIU receptacle in the Monitor MUX cabinet. The monitor computer checks the monitor MUX for lost characters and reads out on an RO Teletypewriter the location of any lost character, and also alarms the operator through the 8404 Console.

BREAK is a "1" signal which indicates to the LSIU that there is an open line. When a selected Input Unit has a Break signal set, it sends the signal to the computer. The operator is alarmed by the "open line" indicator. The LSIU also sends the Break signal to a test point in the top of the 8155 cabinet.

IDLE is a signal sent by an LSIU when an idle line is detected. If the telegraph channel remains marking for a period of five seconds, a thermal delay relay sends the Idle signal to the computer. The Idle and Break signals are joined together in the 8166 as one signal, which can be logically separated by the switcher computer.

LOGIC (See Logic Diagram #360055)

LSIU Interface Each 8155 MUX Cabinet may contain two 8166s each of which can hold up to eight LSIUs. Each LSIU plugs into a separate 22-conductor receptacle. This is the LSIU interface. Through this connection pass the data bits, the four status signals, the d-c electric power, the teletypewriter signals, signal monitor line, and the Input Acknowledge. All these signals except Input Acknowledge travel from the LSIU into the 8166. The Input Acknowledge is generated within the 8166 and is sent to the LSIU to clear the status flip flops.

Fan In The 8166 IMUX takes the data-bit signals and the Status signal lines from all eight of its LSIUs and fans them in to a common signal channel. Thus, data from any of the eight LSIUs is sent to the computer over a single group of wires.

Data For example, Data Bit 0 from each LSIU is AND gated with the select code for that LSIU and OR gated through an inverter to meet at an AND gate. Normally this AND gate is enabled with an output of "0". However, if any of the eight LSIUs shows a "1" in bit 0 when that LSIU is polled or selected, the AND is broken and a "1" is sent through the 8165 MMUX to the computer.

This same fan-in procedure takes place for each data bit where the eight signal lines are fanned in to one.

Lights There are five indicator lamps in a vertical row on the panel. They display the decoder EF select code.

The upper two lights indicate which module (A or B) is communicating with the computer. The top light which is red designates the A module. The second light down which is green indicates the B module.

The lower three lights which are white indicate in binary code which of eight pairs of SL I/O units in the module is selected.

The lights are turned on by the EF code from the computer. They are turned off when the code and Function Ready signals stop.

LOGIC DIAGRAM (See Diagram #360093)

#### Output Logic

Interrupt 30 The Multiplexer operates on a computer interrupt basis. The Interrupt 30 clock in the 8165 MMU is a free running multivibrator. It sets the interval between interrupts at slightly less than the minimum character interval. For example with a TTY rate of 100 wpm where the character interval is 100 msec., the interrupt 30 clock is set to cycle once every 90 msec. Once each cycle the clock sets the interrupt flip flop which notifies the computer that an Interrupt is generated. The computer enters the interrupt routine.

Function Ready The computer sends out a "Function Ready" signal along with an external function select code. The "Function Ready" signal is used throughout the 8165 circuit to enable and/or disable decoding. The programmed external function code selects the assigned output module (A or B) and output unit (one of eight).

**CONTROL DATA  
8167 OUTPUT SLAVE  
MULTIPLEXER**

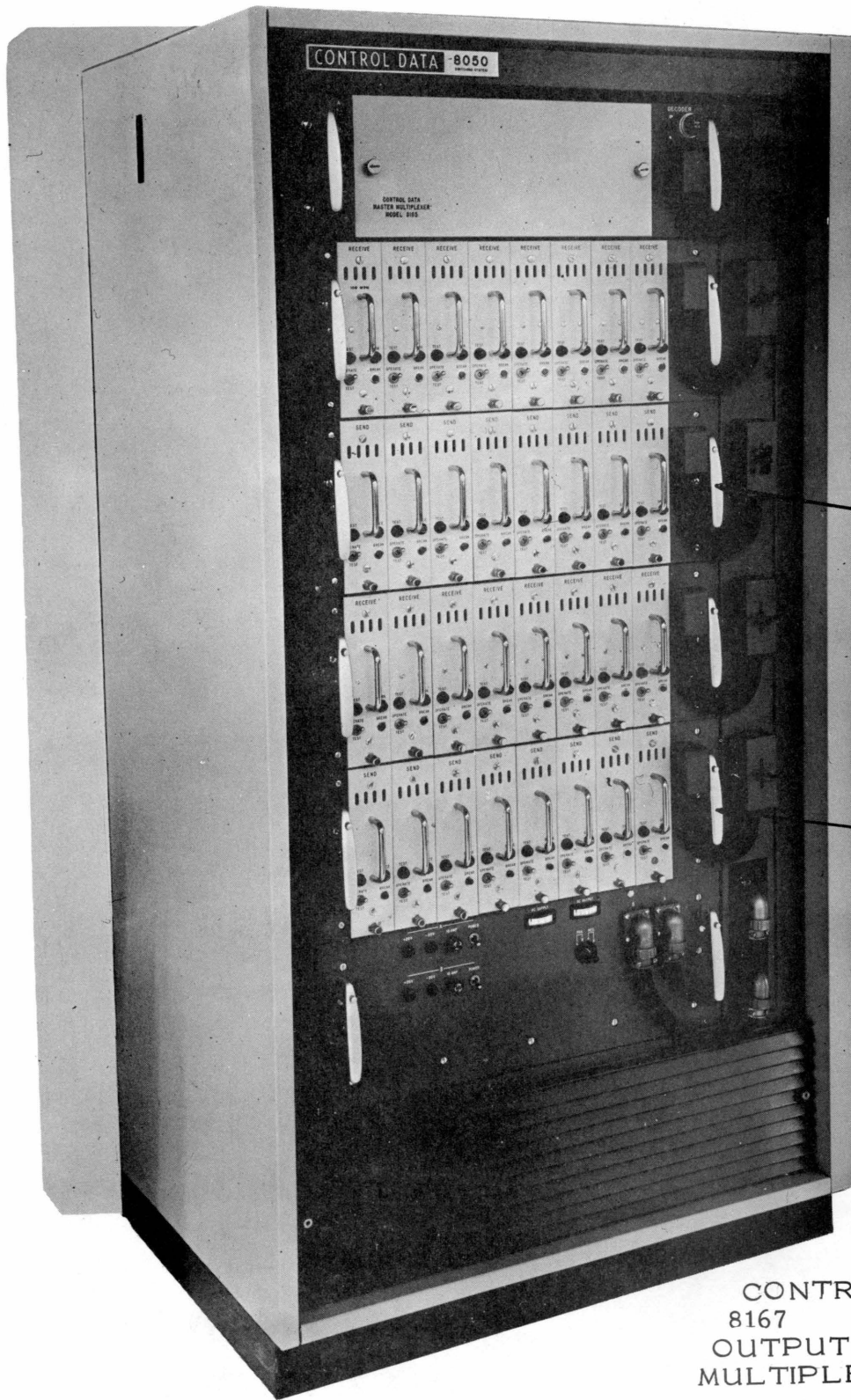

CONTROL DATA  
8167  
OUTPUT SLAVE  
MULTIPLEXER

# CONTROL DATA 8167 OUTPUT SLAVE MULTIPLEXER (OMUX)

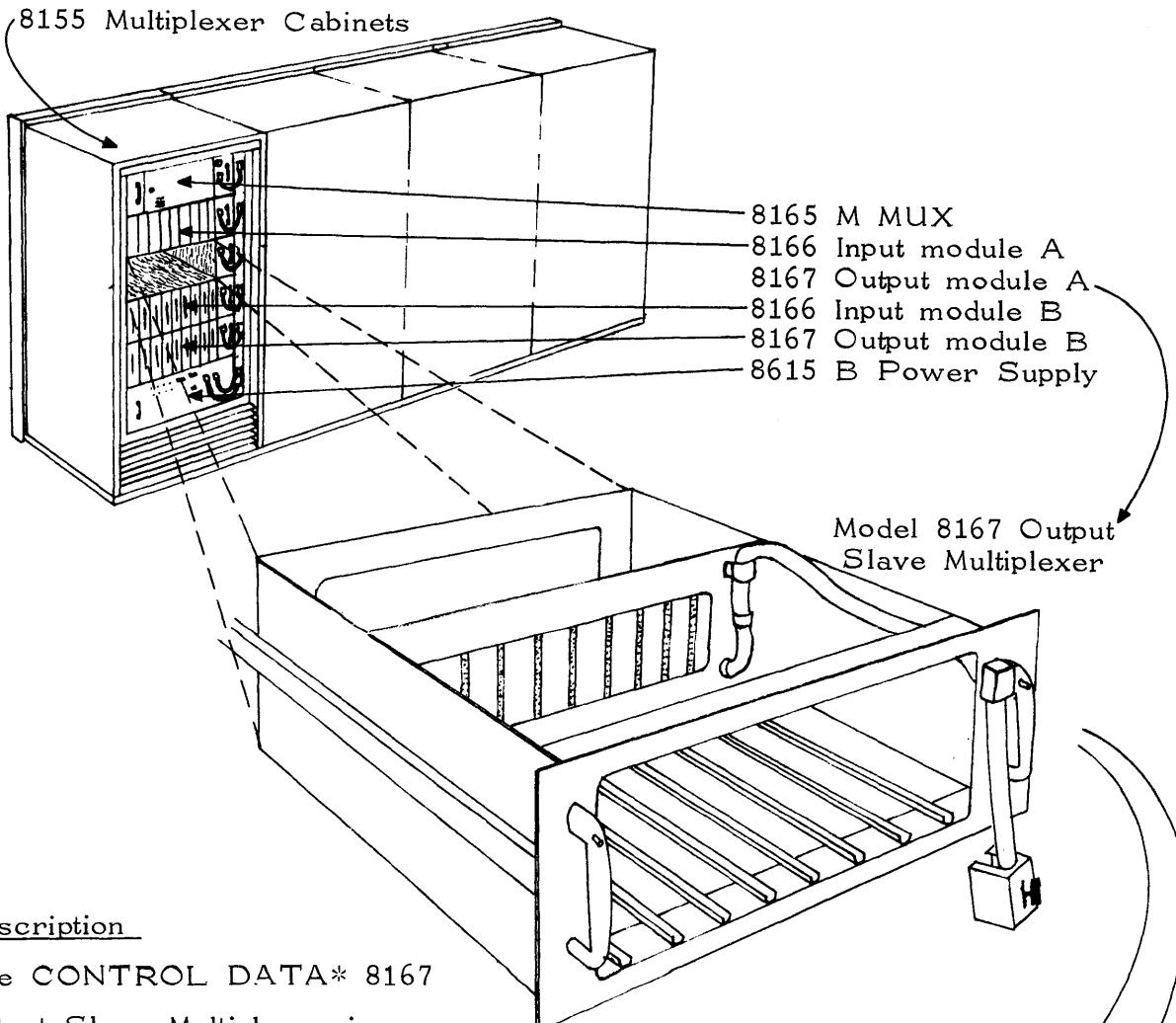

## Description

The CONTROL DATA\* 8167 Output Slave Multiplexer is an electronic data output device that sends data and Output Acknowledge to the selected one out of eight Low-Speed Output Units (LSOUs). It also fans in any or all LSOU character request signals into one signal and gives this Character Request signal to the 8165 MMUX

152-pin plug

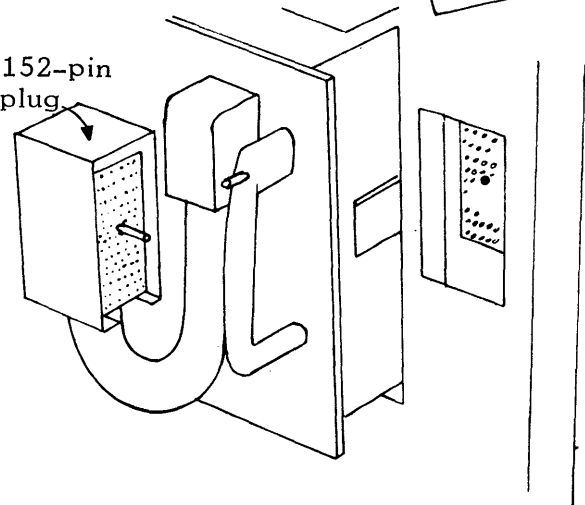

\* Registered Trademark

### Physical Description

The 8167 chassis is in the form of a drawer which fits into the 8155 cabinet. The entire 8167 module slides out on telescoping channels and locks in either the extended or the closed position. Before the "drawer" can be opened the 152-pin plug must be disconnected, and the release buttons on the two pull handles must be depressed. The plug is disconnected simply by unscrewing the wing screw until it is free, and pulling the plug out.

Logic Cards The back part of the module contains the row of logic cards, and the 22-conductor LSOU receptacles.

LSOUs Eight LSOUs slide into channels in the front portion of the 8167 like eight books on a shelf. When the LSOUs are pushed all the way in, they plug into the matching sockets. Each LSOU is locked in with a captive knurled thumb screw.

INPUT/OUTPUT LOGIC (See Logic Diagram #360081)

### Output Logic

An 8167 Output Slave Multiplexer (OMUX) directs the outgoing communication from the 8165 Master Multiplexer to one of eight LSOUs in the 8167 module.

Character Request Each channel that is ready to accept data from the MUX sends a Character Request to the 8167. All of these signals (up to eight) are fanned in to a single Character Request signal and sent to the 8165. If the switcher computer has an output message ready to send it sends a data character along with an Information Ready signal to the 8165. This Information Ready



is combined with the Character Request within the 8165 to form an Output Ready.

This signal has two main purposes --

--to enable the data character to move on through the selected 8167 to (but not into) all eight LSOU's.

--to send an Output Acknowledge signal to the selected 8167 OMUX.

Output Acknowledge This signal enters the 8167 OMUX from the 8165 MMUX signifying that the switcher computer has sent a character. The Output Acknowledge combines with the Select Output signal and the selected LSOU address to direct the Output Acknowledge to the specific LSOU which has been addressed by the computer.

Select Output The computer program directs the 8165 MMUX to select one of the 8167 OMUX's. Both 8167 modules receive the data, the LSOU select code and Output Acknowledge. Only the 8167 that is selected receives a Select Output function code. Select Output plays the important dual role of enabling the Output Acknowledge to the selected LSOU and enabling any existing Character Request in the selected 8167 module.

Select LSOU (bits 0,1,2) The Select LSOU code is sent from the computer, decoded in the master multiplexer, and sent to the 8167 in three parallel bits. These three bits are coded (0 through 7) to represent the octal number of the selected LSOU. The three bits and their complements are multiplexed for two purposes --

--to enable a Character Request coming from any individual LSOU before it is fanned in to a single combined signal from all LSOU's in the module.

--to address the selected LSOU by allowing the Output Acknowledge signal to reach only the one LSOU.

When the Output Acknowledge enters the selected LSOU it enables the data character to enter the LSOU transfer register and starts the character clock. The LSOU converts the character from parallel to serial form and sends it out on the teletypewriter communication line. The LSOU transfer register is cleared. The LSOU sends back another Character Request to the 8167. This enables the output cycle to continue.

# FLOW CHART THE ROLE OF THE 8167 OUTPUT SLAVE MUX IN THE OUTPUT DATA CYCLE

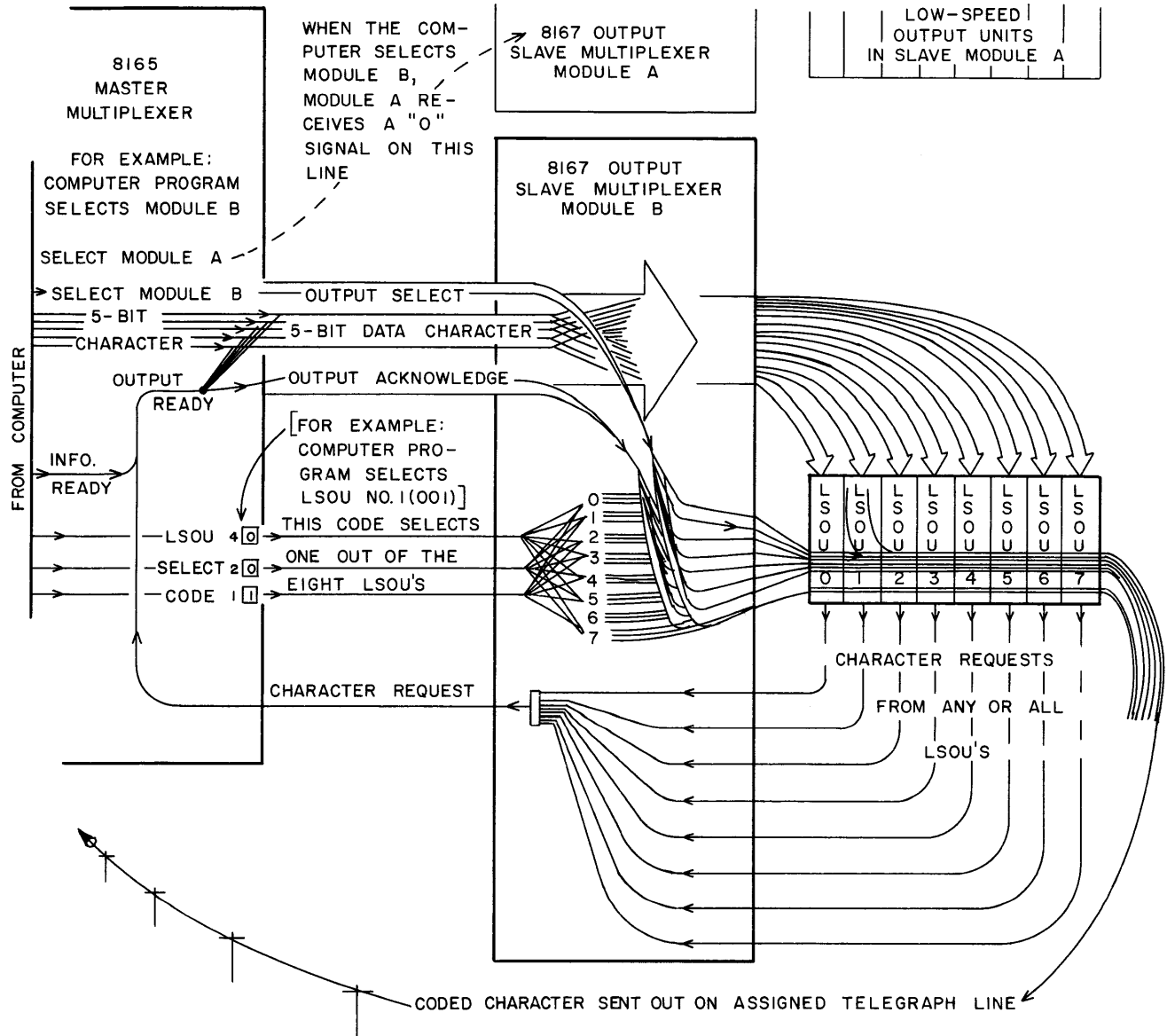



External Function Select Code, 01XX, 02XX

This code is more thoroughly explained in the 8155 section. The first two digits (01 or 02) of the code designate one of two possible groups of four cabinets. The first digit is 0 in this code and is permanently wired so that the three bits enable an inverter  $1^{319}$  to present a "1" when and gated with the second code number. The second number is permanently wired into the decoder plug. In this case where no more than four switcher cabinets are used, the 01XX series is sufficient to handle the whole system. The 02XX series is used for the next group of four cabinets.

Module Selection The third octal digit of the code is divided into three bits in order to select the 8155 cabinet and the module (A or B) within that cabinet. The first two bits designate one of four MUX cabinets. These two bits are

wired permanently into the decoder plug used on a particular cabinet. The third bit AND gates with the other two bits to set the A or B select flip flop.

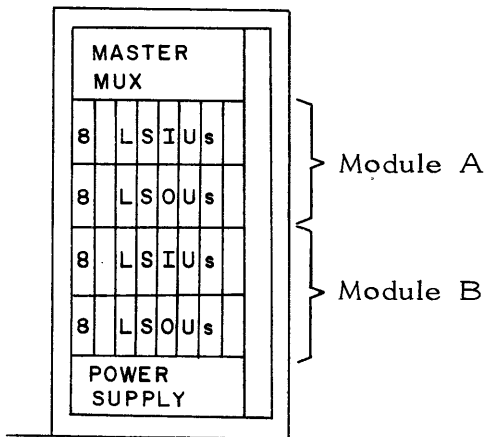

LS I/O Unit Selection The fourth digit of the 01XX code selects one out of eight pairs of LS I/O units. In the 8165 master MUX three flip flops are set or cleared in a combination to designate a particular unit. This code is passed on to the slave MUXs for decoding.

**CONTROL DATA  
8508 LOW-SPEED  
INPUT UNIT**