

MICROCOMPUTER DIGEST

Volume 2, Number 8

February, 1976

INTEL & SIEMENS 2ND SOURCE PACT

Intel Corp. and Siemens jointly announced a cooperation agreement in the field of microcomputers, encompassing microcomputer semiconductor products and related software and support systems.

The agreement covers a cooperation for both current and future microcomputer systems. It provides the means to establish alternate sourcing of each other's microcomputer products.

Both companies reported that they felt the agreement would accelerate their development and promote the use of this new technology.

FAIRCHILD & OLYMPIA SIGN F-8 AGREEMENT

Fairchild Camera & Instrument Corp. has entered into a license agreement with Olympia Werke A.G. involving patents, patent applications and know-how associated with Olympia's microprocessor system. The agreement specifically includes Fairchild's F-8 microprocessor and gives both Fairchild and any second source they designate a broad license with respect to Olympia's microprocessor technology. (cont'd on page 2)

TWO SINGLE CHIP MICROPROCESSORS

The Essex International SX 200 Microprocessor is a complete P-channel MOS 4-bit single chip micro designed to provide the advantages of a computer architecture into a low cost IC.

According to the company, the single chip provides all of the necessary control functions of a CPU, memory and I/O. Using 41 instructions, the 8K-bit ROM is mask programmed to control I/O, logic, arithmetic and data flow functions. The 256-bit RAM provides 64 storage locations for data. In addition to data storage, there are 16 individually settable, resettable and testable flag bits for (cont'd on page 2)

ROCKWELL PPS-8 ASSEMBULATOR

Rockwell Int'l has announced off-the-shelf availability of a new "Assembler" which it described as a "total system development tool" for its 8-bit PPS microcomputers.

The new instrument facilitates assembly, debugging and modification of PPS programs while enabling real-time software check-out of systems with peripherals, encoding of PROMs and EROMs for field testing of prototypes, the generation of ROM mask codes, and can even

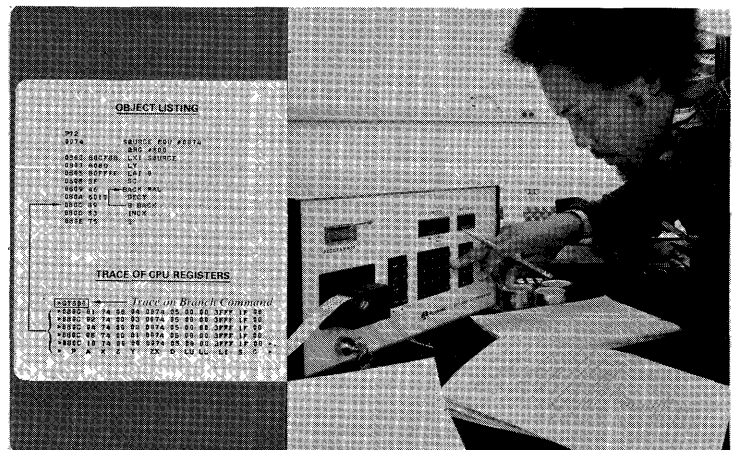

be used for acceptance testing of Rockwell's devices and boards.

Complete with software and comprehensive programming and operating manuals, the instrument, which is designated the PPS-8MP, sells for \$3,450.

The PPS-8MP software consists of a ROM-resident supervisory program providing utility and debugging functions, and RAM-resident assembly and text editing programs.

The assembly program automatically translates the designer's source symbols and addresses into powerful, multi-function PPS-8 instruction machine codes. (cont'd on page 2)



PO BOX 1167, CUPERTINO, CA 95014 • (408) 247-8940

Copyright © 1976 by Microcomputer Associates Inc., All Rights Reserved. M.R. Lemas, President. Published monthly. Subscription \$28.00 per year, overseas \$40.00 per year. DARRELL D. CROW, Editor; LILLIAN LAU, Associate Editor; PATRICIA L. DREISBACH, Circulation Editor; RAY HOLT, Applications Technical Advisor; MANNY LEMAS, Applications Technical Advisor.

SPECIAL FEATURES:

FAIRCHILD & OLYMPIA SIGN F-8 AGREEMENT

(from page 1)

Last month, suit was brought in New York against Fairchild and Dr. David Chung by General Instrument Corp. claiming Fairchild had acquired information about Olympia's microprocessor system from Dr. Chung, a former General Instrument employee. The complaint alleged this information was used in the design of the F-8 microprocessor.

Fairchild, which had denied the allegations, said the Olympia-Fairchild agreement includes a complete release for any possible use of Olympia's information in the F-8 microprocessor or otherwise.

TWO SINGLE CHIP MICROPROCESSORS

(from page 1)

improving program control. The outputs are programmable via a PLA, of which twelve are individually settable and resettable under program control and seven others which output in parallel.

Data input can be in BCD or, if desired, the SX 200 will directly interface with capacitive type touchplates.

The SX 200 is a low-end device intended principally for applications in the home appliance industry. The microprocessor is compatible with touch-plate controls and can be synchronized with the AC power line for direct control of such power devices as SCRs.

A second 4-bit microprocessor, Bitsy, is similar to the SX 200 but lacks its touch-plate compatibility and power-line synchronization. A PROM programmable hardware emulator is available and software support includes a FORTRAN assembler and simulator.

Bitsy contains 256 words of memory, 2-working 6-digit registers, a 6-digit accumulator, 42 instructions and I/O programmable decoding. Quantity pricing for the SX 200 is under \$6 and under \$3 for Bitsy.

ROCKWELL PPS-8 ASSEMBLER

(from page 1)

Supplementing the assembly program is character-oriented text editing software providing

extensive search, replace, insert and delete commands enabling easy modification of the source program. The assembly and text editing software is supplied on tape and is loaded into the machine's RAM with a TTY or TI 733 ASR tape reader, or with an optional high speed reader.

SYSTEM DEVELOPMENT FLOW

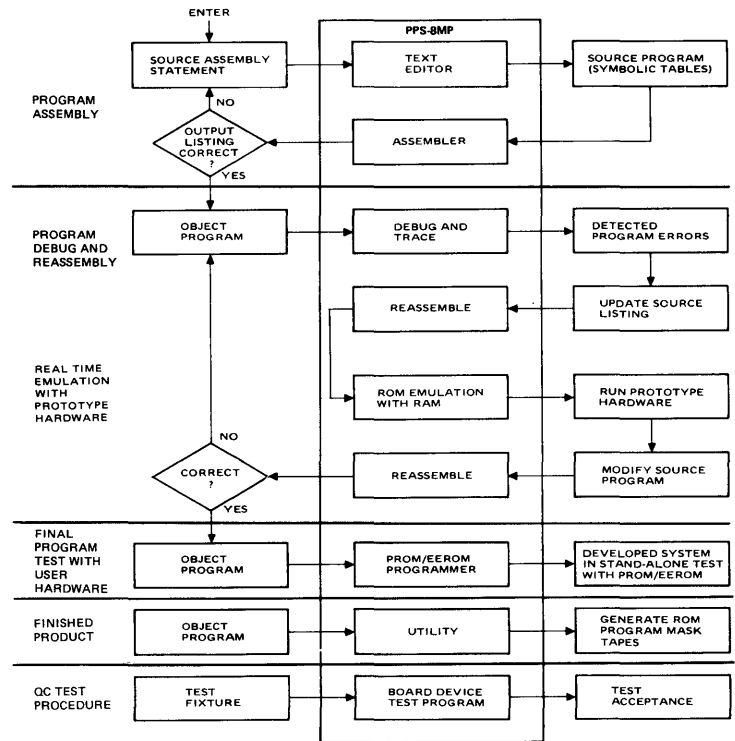

The supervisory program is stored in ROM which is supplied on a plug-in module in the assembler. Debug and utility functions include independent I/O re-assignment, break pointing, single stepping, selective tracing, and register or memory examination and modification.

After field prototyping is completed, the PPS-8MP may be used to generate the tapes used to define the ROM mask. The system can also emulate any chip on a system's board, and techniques have been developed by which it can be used for acceptance testing of incoming devices and boards.

Components of the basic machine are a PPS-8 CPU, 6K bytes of RAM which are switch selectable in 2K byte segments for use in any



PO BOX 1167, CUPERTINO, CA 95014 • (408) 247-8940

Copyright © 1976 by Microcomputer Associates Inc., All Rights Reserved. M.R. Lemas, President. Published monthly. Subscription \$28.00 per year, overseas \$40.00 per year. DARRELL D. CROW, Editor; LILLIAN LAU, Associate Editor; PATRICIA L. DREISBACH, Circulation Editor; RAY HOLT, Applications Technical Advisor; MANNY LEMAS, Applications Technical Advisor.

proportion of instruction or data storage, four-wire port and mating plug for ASR-33 TTY type terminals, RS232-C compatible port for TI 733 ASR type terminals, hexadecimal control keyboard, hexadecimal memory address and I/O bus display, power supply and chassis with slots for a variety of additional modules.

According to Rockwell, one of the most powerful options for the PPS-8MP Assemulator is a floppy diskette operating system (FDOS—scheduled for availability early in 1976). The FDOS option includes an intelligent disc controller packaged with dual disc drive and a powerful software extension of the basic supervisory program.

NATIONAL INTRODUCES SC/MP

National Semiconductor Corp. has officially introduced the SC/MP microprocessor. SC/MP is a programmable 8-bit parallel processor implemented on a single integrated circuit chip. It contains one 8-bit accumulator, four 16-bit pointer registers (one of which is dedicated as the program counter), an 8-bit status register, and an 8-bit extension register. With all of this built in, SC/MP can directly address up to 65K bytes of memory.

SC/MP Functional Block Diagram

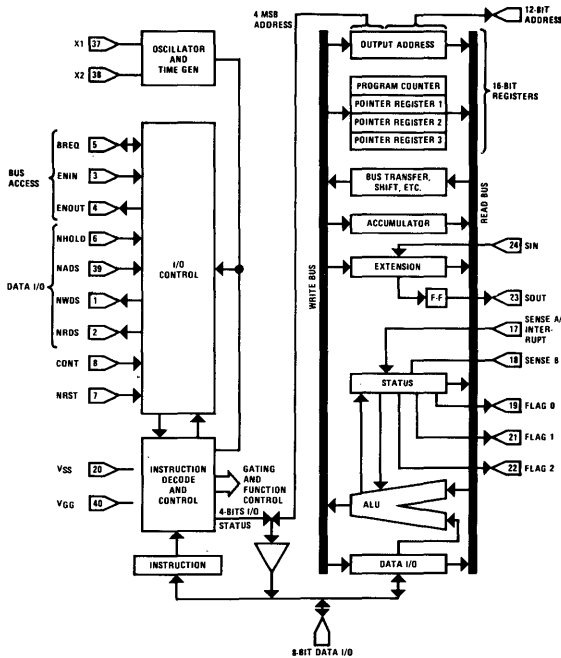

The architecture of SC/MP is designed with on-chip timing circuits, eliminating expensive

cumbersome clocks. It also offers TTL compatibility for easy interfacing with other components within a system.

Architecturally, SC/MP employs a unified bus system in which the CPU, memory and peripheral devices are all connected to a common data bus. This configuration enables memory reference instructions to reference peripheral devices. It also allows multiple SC/MPs to be tied to the bus for daisy chain operation; when one SC/MP stops transmitting or receiving, it notifies the next SC/MP in line that it can take over. In addition, SC/MP architecture provides serial data and control streamlining under software control and has built-in programmable delay.

SC/MP is priced at \$10 in quantities and samples are now available from the factory.

OEM MICROCOMPUTER SYSTEM CARDS

Microcomputer Associates Inc. has announced a new series of OEM Microcomputer System Cards. The new System Cards are designed as low cost, stand-alone cards with full microcomputer capability including PROM and RAM memory and I/O.

The series consists of four cards, each based around different microprocessors: the 8080A, the 6502, the 6800 and the 2650.

Each card contains a crystal-controlled clock, 1K x 8 static RAM, 2K x 8 PROM sockets or 4K x 8 mask ROM sockets, 24 bidirectional I/O lines, fully buffered address/data lines, DMA capability, interrupts, full temperature range operation (0°C to 70°C), and a small size of 4.25" x 7". Each card is fully assembled and tested.

The cards offer a unique interconnection technique for minimizing the cost of expensive card cages and backplanes should additional cards be needed. Other card sizes are available with minimum order.

A spokesman for MAI states that "the cards are designed to satisfy 90% of small-to-medium OEM requirements and can be used as the main processing card by 75% of the large OEMs. Furthermore, by offering the cards with several microprocessors, they can be used to replace a wide range of existing designs already based around existing microcomputer software, such as for the 8080 and 6800."

(cont'd next page)



PO BOX 1167, CUPERTINO, CA 95014 • (408) 247-8940

Copyright © 1976 by Microcomputer Associates Inc., All Rights Reserved. M.R. Lemas, President. Published monthly. Subscription \$28.00 per year, overseas \$40.00 per year. DARRELL D. CROW, Editor; LILLIAN LAU, Associate Editor; PATRICIA L. DREISBACH, Circulation Editor; RAY HOLT, Applications Technical Advisor; MANNY LEMAS, Applications Technical Advisor.

MAI states that "there are numerous firms with end-user experience that could use an OEM Microprocessor System Card but do not have the time or expertise to develop their own boards....these are the people we are interested in."

To further support this new series of cards, MAI has available 4K x 8 RAM cards, 2K, 4K or 8K x 8 PROM cards, I/O cards and power supplies in addition to extensive software applications support should the user need help in "bringing up" their microcomputer-based products.

Typical applications include industrial process control, intelligent instruments, data communications, "smart" controllers, small business systems and video games.

Prices start at \$375 in single unit orders and \$295 in 100's. Quantity and OEM discounts are available upon request. Delivery is 30-45 days ARO.

INTEL SINGLE BOARD COMPUTER

The Single Board Computer, a complete computer system contained entirely on one small, plug-in circuit board, has been introduced by Intel Corp.

The new computer, SBC 80/10 Single Board Computer, is designed to be used as a complete one-board computer subsystem. It provides processing power, memory storage capacities, and I/O facilities required for most OEM processing and control subsystem applications, said Bill Davidow, manager of microcomputer products.

The key to the SBC 80/10's versatility is its programmable parallel and serial I/O, which allows OEMs to use the same SBC in different equipment models or entirely new generation equipment requiring different I/O configurations and data transfer techniques, by simply changing a few program instructions and plugging in appropriate line drivers and terminators.

The SBC sells for \$295 in quantities of 100 and \$495 in single unit quantities. The board measures 6.75" by 12".

The board contains a complete central 8080A processor subsystem with all required control circuitry, crystal-stabilized system clock, system bus control, high current drivers for

expanding memory and I/O capacities via the system bus, 1K static RAM, up to 4K of ROM, parallel I/O with 48 I/O ports, serial I/O with programmable USART, RS232C and TTY interfaces.

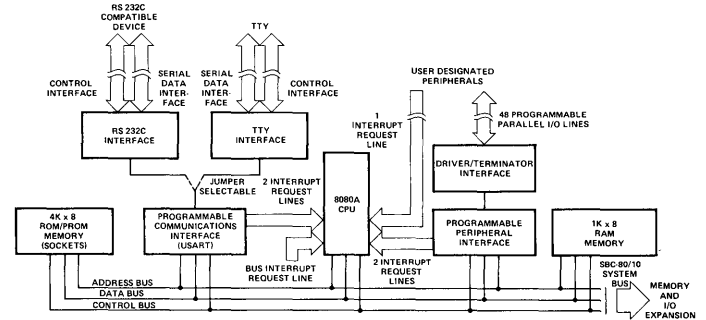

1. Interrupts originating from the Programmable Communications Interface and Programmable Peripheral Interface are jumper selectable.

SBC 80/10 BLOCK DIAGRAM

Davidow noted that the board is the first OEM computer to be assembled almost entirely with LSI devices. These include the 8080A microprocessor, 8251 USART, two 8255 Programmable Peripheral Interface units, eight 8111 1K-static RAMs, four optional 8708 8K EPROMs or interchangeable 8308 masked ROMs.

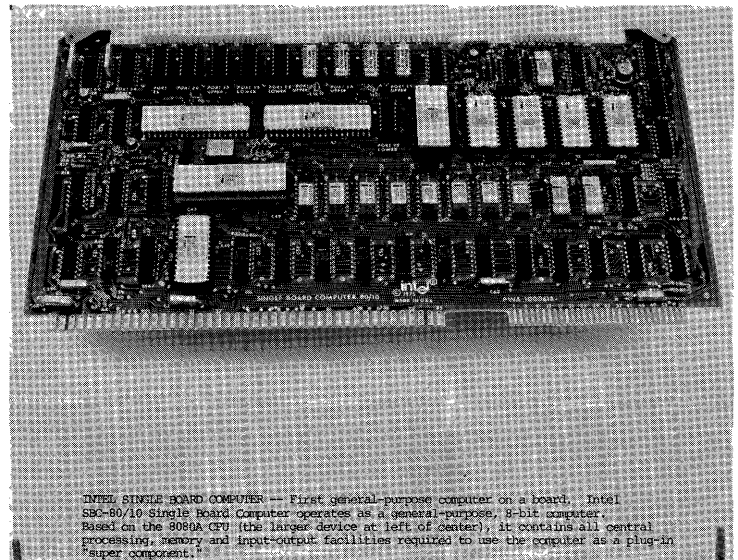

INTEL SINGLE BOARD COMPUTER - First general-purpose computer on a board. Intel SBC-80/10 Single Board Computer operates as a general-purpose 8-bit computer. Based on the 8080A CPU (the larger device at left of center), it contains all central processing, memory and input-output facilities required to use the computer as a plug-in "super component."

Standard boards and cardcage assemblies are available to expand SBC 80/10 memory and I/O capacity. The SBC-016 16K RAMboard, SBC-406 6K PROM board, and SBC-416 16K PROM board can all be used to expand SBC 80/10 memory. The SBC-508 general purpose I/O board provides an additional 32 input and 32 output lines. The SBC-104 combination memory and I/O expansion board provides 4K bytes of RAM, ca-

(cont'd next page)



PO BOX 1167, CUPERTINO, CA 95014 • (408) 247-8940

Copyright © 1976 by Microcomputer Associates Inc., All Rights Reserved. M.R. Lemas, President. Published monthly. Subscription \$28.00 per year, overseas \$40.00 per year. DARRELL D. CROW, Editor; LILLIAN LAU, Associate Editor; PATRICIA L. DREISBACH, Circulation Editor; RAY HOLT, Applications Technical Advisor; MANNY LEMAS, Applications Technical Advisor.

capacity for 4K bytes of EPROM or ROM, 48 programmable I/O lines, and a programmable communications interface with RS232C compatibility. Expansion boards may interface with the SBC 80/10 using a standard modular expandable cardcage, which houses up to four boards.

Intel's entire line of 8080 hardware and software development aids can be used in support of the SBC 80/10.

TECHNOLOGY:

MOSTEK LOWERS F8 PRICES

Mostek has announced lower prices on the company's 2-chip F8 microcomputer family. The MK 3850 CPU and the MK 3851 PSU (Program Storage Unit) were reduced from \$64 to \$28 in 100-999 quantities and from \$85 to \$55 in single unit quantities.

Van Lewing, Mostek's microcomputer marketing manager, emphasized that this price reduction now allows a user to define a complete F8 system with 1K ROM, 48-bit I/O ports, one timer, 64 bytes of RAM and 2 interrupts for less than \$45 for 1000 sets.

Mostek's F8 evaluation kit, dubbed "The Survival Kit," remains at \$297 unassembled and \$397 assembled. Since the recent announcement of this kit, a FORTRAN IV cross-assembler which runs on 16-bit computers has been added at no cost to the package.

MICROCOMPUTER-BASED PRODUCTS:

2650 SOFTWARE DEVELOPMENT SYSTEM

The μ Pal 265 SDS Software Development System by Processor Applications Ltd., is the latest software development tool designed for the Signetics 2650 microprocessor. According to Dan Nesin, president, the hardware design has been optimized to provide maximum versatility and reliability to the user at minimum cost.

At the system's heart is a Signetics 2650 microprocessor which resides on the CPU card together with the μ Pal Monpal system monitor. The monitor is contained in 2K bytes of PROM. An I/O interface card contains all the necessary logic to interface the 265 to a TTY, CRT or a high speed paper tape reader. An EIA

RS232C interface is provided as well as a control line for an external device such as an ASR-33 reader.

The 8K memory card, which completes the basic system, is fabricated with popular static RAMs and can be strapped to reside anywhere in the 2750 usable memory space.

Nesin said the μ Pal Fixit editor is a character string editor available standard on paper tape or purchasable in PROM. The resident version does not have to be loaded for each use.

The μ Pal assembler is contained in 5K bytes of memory. Variable length symbols are used to optimize space with the assembler supporting approximately 380 4-character labels in the basic system.

The assembler also allows (1) the symbols to be defined externally and (2) large programs to be segmented on tape for ease of storage and future editing. Left and right margin control is provided to allow assembly of source tape dumps from timesharing or source computers other than the μ Pal 265 SDS.

The μ Pal SDS is priced at \$5,550 and delivery is 30 days.

MULTI-MICROPROCESSOR NETWORK

Codex Corp. has unveiled a family of multi-microprocessor implemented computers dedicated to communications and capable of processing more data than previously assigned to front-end processors.

In addition to handling message management and network protocol, the new 6000 Series of Intelligent Network Processors are capable of replacing conventional time-division multiplexers while adding error control and providing a higher level of data compression.

The INP series is complemented by a wide choice of peripherals and price is dependent upon system configuration.

SOURCE 700

MSI Data Corp.'s new programmable off-line remote data terminal, designated the SOURCE 7600, was announced by Gary E. Liebl, vice president of marketing.

The new source data entry terminal incor-
(cont'd next page)



PO BOX 1167, CUPERTINO, CA 95014 • (408) 247-8940

Copyright © 1976 by Microcomputer Associates Inc., All Rights Reserved. M.R. Lemas, President. Published monthly. Subscription \$28.00 per year, overseas \$40.00 per year. DARRELL D. CROW, Editor; LILLIAN LAU, Associate Editor; PATRICIA L. DREISBACH, Circulation Editor; RAY HOLT, Applications Technical Advisor; MANNY LEMAS, Applications Technical Advisor.



porates an Intel 8080 microcomputer, which is permanently programmed with a full set of basic programming commands to allow the onsite, non-technical operator to create original formats for data input. A special "Free Form" mode allows the terminal to accept and then transmit narrative, unformatted data as well, so that special instructions and other messages can also be communicated to and from the computer center.

One cassette drive is standard; a second cassette is optionally available for greater convenience in loading programs, editing and duplicating cassettes.

The machine incorporates both a full typewriter keyboard and a separate accounting-style 10-key touchpad for rapid entry of numeric data. A 32-position LED display permits the operator to edit each line of data while still buffered before it is printed on the 32 character journal tape. An external line printer can be interfaced to the SOURCE 7600.

SOURCE 7600 will be available in production quantities in April 1976; delivery is 60 days ARO. The unit is priced from \$3500 to \$4500, depending upon optional features, in quantities up to 10; discounts are available.

WINCE MICROCOMPUTER

Wintek Corp. has unveiled their Wince control module, a single card microcomputer system incorporating the M6800 microprocessor. The 4½" x 6½" PC board contains one 6800,

clock, 512 or 1024 bytes of EROM, 128 to 512 bytes of RAM, serial I/O (one ACIA UART compatible interface), and parallel I/O (one or two PIAs—16 lines each). WINCE is fully expandable to 64K bytes of ROM, RAM and/or I/O. Firmware includes FANTOM—a debug/monitor program that allows loading, debugging and saving of user programs. Prices range from \$238-\$398 depending on configuration and quantity.

Other WINCE modules available now include a RAM module containing up to 16K bytes and a PROM programmer. The company reports that other WINCE modules are currently in development. Available software includes a cross assembler, simulator, and PL/W for the 6800.

µC INTELLIGENT MATRIX PRINTERS

Sycor has unveiled an extension of its distributed computing concept, a new series of microcomputer-controlled, intelligent matrix printers of its own design and manufacture, for use on the Sycor 440 clustered terminal processing system.

The printers, operating at 60, 120 and 180 cps, use a microcomputer with 5K bytes of memory for real time control of all system dynamics, including print head needle timing, character registration, paper acceleration profiles, and adaptive print head acceleration and deceleration; and performs multiple task processing for simultaneous data transfer, line feed, keyboard scanning and indicator drive.

Lease pricing is available with the purchase price beginning at \$5600. Deliveries are expected in the second quarter, 1976.

DISC-BASED MICROCOMPUTER

The boxed version of DEC's LSI-11, the PDP-11V03, consists of the PDP-11/03 dual floppy drives, and offers a choice of the LA36 printer or VT52 CRT terminal. The microcomputer is supplied with the TR11 real time OS and total capacity of the floppy disc drives is greater than 500K x 8 with an average access time of 483 µs. Bidirectional transfer occurs at 10K.

The PDP-11V03 is priced at \$9950. FORTRAN IV or BASIC is optional.



PO BOX 1167, CUPERTINO, CA 95014 • (408) 247-8940

Copyright © 1976 by Microcomputer Associates Inc., All Rights Reserved. M.R. Lemas, President. Published monthly. Subscription \$28.00 per year, overseas \$40.00 per year. DARRELL D. CROW, Editor; LILLIAN LAU, Associate Editor; PATRICIA L. DREISBACH, Circulation Editor; RAY HOLT, Applications Technical Advisor; MANNY LEMAS, Applications Technical Advisor.

μCs JOIN U.S. CELEBRATION

As 1976 quickly pushes forward, more and more spectators are joining the U.S.'s 200th birthday celebrations. The latest, microcomputers. A microcomputer has been tied to a digital voice synthesizer and recites the Gettysburg address. Another micro sews stars and stripes on flags. And if you're in Nevada, you can challenge the F8 microprocessor to the exciting game of Black Jack.

μC DATA & TIMING GENERATOR

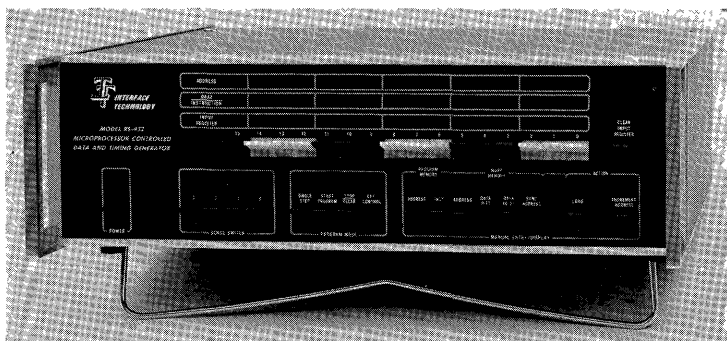

A microcomputer controlled data and timing generator Model RS-432 has been developed by Interface Technology for use in digital circuitry testing where unique digital patterns and special control timing signals are simultaneously required. The TS-432 achieves its sophistication by blending two concepts, digital word generation with microprocessors.

The microcomputer can be programmed to allow the user to generate serial or parallel data with specified output periods; generate data from selected blocks of word memory; generate data contingent upon special inputs such as levels, pulses or sense switches; as well as generate data continuously or in single shots.

The instrument is completely self-contained and requires no external clocks or DC power. The unit is priced at \$4995 with delivery of 10 to 12 weeks.

μC-BASED MULTIPLEXER

A new 8080 microcomputer-based multiplexer from Computer Transmission Corp. (TRAN) accom-

modates up to 16 asynchronous, 8 synchronous digital data channels or a mix of both.

Intended for simple point-to-point multiplexing between terminal clusters and computer centers, the M1308 Multitran multiplexer supports wide mixes of RJE terminals, synchronous CRT controllers and interactive asynchronous terminals over a single voice-grade telephone line.

The microcomputer makes format compatibility possible with TRAN's other network products such as the M1100 series multiplexers, M3000 Network Management switches and M3200 PACUIT Networks. Programming makes the multiplexer flexible, because a new program loaded into the microcomputer meets new synchronous and asynchronous channel allocation needs. Constructed with a single logic circuit board and a separate plug-in power supply, the multiplexer provides maximum up-time, since the device is so easy to repair.

The basic M1808 is priced at \$1800 with other configurations available. Quantity discounts are available. A complete basic 16-channel point-to-point multiplexing network between a terminal cluster and a computer center costs less than \$8000.

INTELLIGENT DATA PROCESSING TERMINAL

Under development at General Computer/Systems, HAROLD is a transaction-oriented general purpose computer system with communications capabilities.

The system contains a DEC LSI-11 microcomputer, 40K of memory expandable to 256K, and will support up to eight 612 character CRT terminals. East CRT terminal is capable of funning a different program simultaneously with the system running several background programs. Other features include cartridge discs, diskettes, printers, tape drives and card readers.

User programmable in ASNI compatible COBOL, the system will have its own disc operating system and will support sequential, relative and index files. In a Distributive Information Network, HAROLD will be able to accommodate 2100 users simultaneously.

#



PO BOX 1167, CUPERTINO, CA 95014 • (408) 247-8940

Copyright © 1976 by Microcomputer Associates Inc., All Rights Reserved. M.R. Lemas, President. Published monthly. Subscription \$28.00 per year, overseas \$40.00 per year. DARRELL D. CROW, Editor; LILLIAN LAU, Associate Editor; PATRICIA L. DREISBACH, Circulation Editor; RAY HOLT, Applications Technical Advisor; MANNY LEMAS, Applications Technical Advisor.

8080 MICROCOMPUTER CARD

Data Works Instrumentation is marketing their Model 226 8-bit microcomputer. The Intel 8080-based system contains DMA address and data-bus drivers, status latches, crystal clock and 8-bit vectored priority interrupt.

The output frequency can be divided down for serial data communications. A company spokesman noted that the firm is planning several new systems that will use other microprocessors.

µC INTERFACE FOR WANG 600/700

Digital Laboratories is using a built-in microcomputer in their WU-7 to allow any Wang 600 or 700 programmable calculators to communicate between themselves, with other computers, terminals and many other devices at data rates from 110 to 9600 bps. The \$2450 instrument performs code translation, formatting, buffering, serializing, etc., so that the simple I/O procedures of the calculators are retained.

ACQUISITION/ANALYSIS/CONTROL SYSTEM

The PAC-10 Portable Data Acquisition, Analysis and Control System is currently available from Forth, Inc. The microcomputer-based system includes a full graphic terminal, 512K bytes of floppy disc storage system, 16-channel multiplexed A/D converter and digital I/O.

TI TERMINAL POLLING SYSTEM

A new system designed to query disbursed networks of Silent 700 Model 742 Programmable Data Terminals has been introduced by Texas Instruments.

The new 700 TPS Terminal Polling System consists of a TI 900 microcomputer with up to 64K bytes of RAM, a TI 9-track, 800 or 1600 BPI tape drive and a Silent 700 Model 733 ASR data terminal with dual magnetic tape cassettes. By using up to four built-in modems and auto call units, the system can poll as many as 200 model 742 terminals over as many as four telephone lines. Or, as an alternate

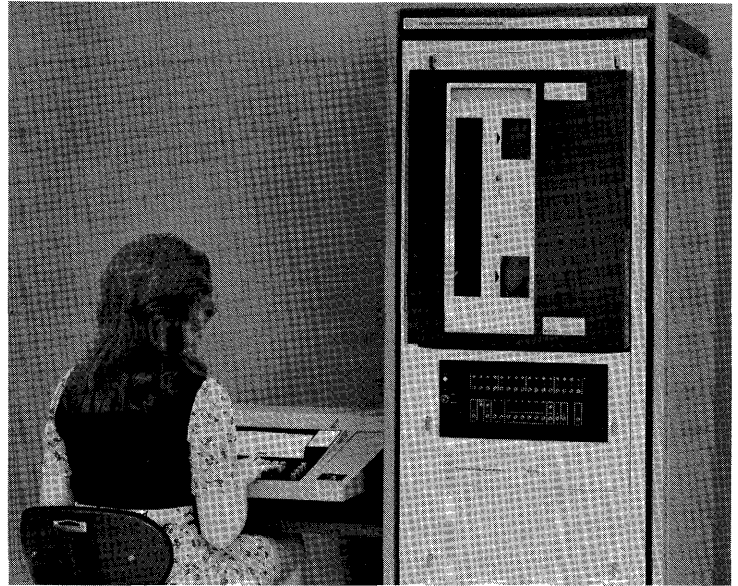

configuration, the system can accommodate up to eight telephone lines with the addition of external modems and auto call units.

A major feature of the polling system is that it collects and stores data in an IBM compatible format. Following system start-up, the 700 TPS automatically polls and stores data on a 9-track tape in a format compatible for processing by a host computer. In turn, resulting output from the host computer can be redistributed automatically via the TPS to the terminal network.

Base purchase price for the TPS is \$37,800 and the 12-month lease rate is \$1,200, including maintenance. Deliveries will begin in March 1976.

RECEIVE-ONLY TELEPRINTER

Marketed by Extel Corp., the RO Receive-Only teleprinter contains built-in service diagnostics that are controlled by a microcomputer. Selectable online, type choices include upper/lower case, expanded or bold-face character and underlining. Continuous short-line printing needs no fill character.

Optionally available are 103, 108 or 113 type built-in modems; selective calling for most 5-, 6-, or 8-level procedures; 20-character answerback; page formatting; and national alphabet or special character sets.

#



PO BOX 1167, CUPERTINO, CA 95014 • (408) 247-8940

Copyright © 1976 by Microcomputer Associates Inc., All Rights Reserved. M.R. Lemas, President. Published monthly. Subscription \$28.00 per year, overseas \$40.00 per year. DARRELL D. CROW, Editor; LILLIAN LAU, Associate Editor; PATRICIA L. DREISBACH, Circulation Editor; RAY HOLT, Applications Technical Advisor; MANNY LEMAS, Applications Technical Advisor.

ADC MICROCOMPUTER

Series 70, based on an Intel 8080 microprocessor, is a complete general purpose microcomputer designed by Applied Data Communications for communications systems, test applications, process controls, monitoring, data acquisition and dedicated ROM operated device controllers.

The system offers 4K RAM expandable to 16K and 1K ROM expandable to 4K. Terminal communication is provided for TTY, CRT or modem through an asynchronous I/O with speed-select from 110 to 9600 baud. Peripheral communications is through two flat ribbon cables, and both DMA and non-DMA device controllers can be used.

Options include a front panel console, IBM compatible floppy disc for interfacing up to eight drives, a tape cartridge, programmable real time clock, line and character printers, 7- or 9-track magnetic tape, synchronous/asynchronous communications, general-purpose I/O card, and ROM programmer. Software support includes a debugger, assembler and an editor on the disc.

MODULAR μ C INTERFACES TO PDP-11

Wyle Computer Products, a division of Wyle Laboratories, announced a new modular 8080 microcomputer system. The μ P Series microcomputer system is designed with major subsystems on individual logic cards to allow the designer flexibility in configuring memory and I/O structure. The card size is directly compatible with the existing Wyle logic and card line, allowing for interface development and packaging in the same card file with the microcomputer system. A unique aspect of the μ P Series is the availability of an interface to the DEC PDP-11, which allows the PDP-11 to exercise full control over the microprocessor address, control and I/O busses. This, along with a proprietary Microprocessor On-Line Development System (MODS) and cross assembler, also available from Wyle, allows the user to completely develop and debug microcomputer software utilizing the larger system. A RAM/ROM memory module is available for program development directly on the mi-

crocomputer system.

The μ P Series CPU module is priced at \$170. Memory is priced at \$100 for 1K RAM and \$245 for the RAM/ROM module. Other modules are priced from \$30.

4-BIT GENERAL PURPOSE COMPUTER

The Automated Computer Systems-4040MC Microcomputer is a low cost, totally self-contained PCB modularized parallel 4-bit general purpose programmable computer. The 4040MC can be configured as an Assembler/Simulator-PROM programmer software development microcomputer system with supporting operating system software, or as a conventional microcomputer to be customized and programmed by the user for various applications.

The basic microcomputer contains five basic functional plug-in modules that are interconnected through a 14 PCB slot PC mother board card rack assembly housed in an aircooled cabinet.

The functional modules include an Intel 4040 microprocessor CPU board, a combination 2K PROM/1280 word data RAM/16-buffer Output port board, an 8-port tri-state universal I/O board with handshaking capabilities, a plug-in switching regulated power supply module, and a full computer control/HEX display panel board. The interconnect mother board provides spare PCB connectors for user custom expansion using either additional basic functional modules or standard module options.

Single unit price is \$2,115 and delivery is 45 days.

8080-BASED MEMORY MODULE

The MI² Data Systems Inc. DESIGN 349 Memory Module is an Intel 8008 microcomputer-based message processing system. The standard 349 has its assembler program stored in 2K ROM and has a 2K RAM for data or additional program storage. The RAM can be expanded to 6K in 1K segments.

The 2K ROM containing the assembler program can be replaced with a ROM set of 256 to 2048 characters containing a special application-oriented program. This special program approach requires no initial loading from ex-

(cont'd next page)



PO BOX 1167, CUPERTINO, CA 95014 • (408) 247-8940

Copyright © 1976 by Microcomputer Associates Inc., All Rights Reserved. M.R. Lemas, President. Published monthly. Subscription \$28.00 per year, overseas \$40.00 per year. DARRELL D. CROW, Editor; LILLIAN LAU, Associate Editor; PATRICIA L. DREISBACH, Circulation Editor; RAY HOLT, Applications Technical Advisor; MANNY LEMAS, Applications Technical Advisor.

ternal storage but is restricted to applications where program changes are not required.

The DESIGN 349 uses its internal 8008 to control its basic I/O and arithmetic functions for such applications as message storage, code conversions, data rate conversion, data formatting and data logging for peripherals.

Further expansion of the memory from 6K to 14K, in increments, is available as a factory option.

TENNEY MICROCOMPUTER PROGRAMMER

Tenney Engineering is introducing a completely new programming module using microcomputer techniques. Offered as a standard option, the new programmer interfaces with all Tenney environmental test chambers and can be used in place of older cam, two-point or punched tape programmers.

With programmable memory, the instrument is digitally addressed in English terms. The microcomputer assumes command of temperature and humidity set-points, slope rate, dwell time, and secondary functions such as mode selection.



#

Check to make sure you don't miss an issue of MD by letting your subscription run out.

WHERE SHE STOPS . . .

Determining where the wheels on a slot machine will stop is the major function of an Intel 4004 microcomputer now incorporated into a new series of electronic one-armed bandits manufactured by Allied Leisure Products. The machine will effectively look and operate the same as the mechanical types currently used in Nevada, reports the company. It will even have the same old familiar clunk-clunk-thanks sound.

MICROCOMPUTER SOFTWARE:

F-8 CROSS-ASSEMBLER

A cross-assembler for the Fairchild F-8 microprocessor has been developed by Logic Systems. Designed to run on a PDP-8 microcomputer, the software will handle any size program up to a maximum of 600 labels.

Features of the program, according to the company, are free form input data, formatted list output, "Fair Bug" loader format, and a simplified instruction set. The assembler resides in 8K of memory.

INTERMETRICS DEVELOPS M6800 PL/M

Intermetrics has developed a high-level programming language, PL/M6800 for the Motorola 6800 microprocessor. The program produces optimized object code in a format directly usable by the Motorola Minibug/Mikbug and Ex-bug loader functions.

Intermetrics reported that the PL/M6800 compiler is compatible with Intel's PL/M language. The compiler is available on GE Information Services Timeshare Systems. The company also said the compiler will be available for purchase at a later date. The program runs on IBM 360 and 370 computers.

8080 ASSEMBLER/SIMULATOR

Two software products available from FBE allow users to simulate products using the 8080 microcomputer on any 4K DEC PDP-8 mini-computer.

Cal-80 is a three-pass symbolic assembler



PO BOX 1167, CUPERTINO, CA 95014 • (408) 247-8940

Copyright © 1976 by Microcomputer Associates Inc., All Rights Reserved. M.R. Lemas, President. Published monthly. Subscription \$28.00 per year, overseas \$40.00 per year. DARRELL D. CROW, Editor; LILLIAN LAU, Associate Editor; PATRICIA L. DREISBACH, Circulation Editor; RAY HOLT, Applications Technical Advisor; MANNY LEMAS, Applications Technical Advisor.

that accepts 8080 instructions from paper tape and produces a PROM image tape and a formatted program listing. SIM-80 is an interactive simulator that emulates the 8080 on the PDP-8. Each program is available in paper tape for \$15 or as a source listing for \$50.

UCC SUPPORTING POPULAR μ Ps

University Computer Co. (UCC) has announced that a series of assemblers, debuggers and support software for a number of popular microprocessor are currently available on their remote computing network.

Available simulators handling the ROM/RAM environment, simulated interruptions and I/O operations were designed to aid debugging of programs for the Intel 4040, 4004, 8080 and 8008, Fairchild F8 and others.

NEC TIMESHARE NETWORK

A worldwide timesharing network for developing and simulating programs for the 8080 microprocessor has been announced by NEC Microcomputers. The service is accessed through GE's Mark III timesharing network. The library contains assemblers, debuggers, simulators and editors.

8080 RESIDENT ASSEMBLER

An 8080 resident assembler that assembles a compatible subset of the Intel language and generates machine code directly into memory for immediate execution has been developed by Micro Systems Software.

Occupying less than 2K bytes of PROM or ROM, the language features all Intel-defined instruction mnemonics and special program pseudo-ops, including DB, DW, DS, ORG, EQU, and END. The assembler is priced at \$495 and delivery is one week.

μ C LINE OF CROSS-ASSEMBLERS

First Data has announced the availability of cross-assemblers for the Fairchild F-8, Intel 8080, TI TMS 8080, Motorola M6800 and the LSI-11 microcomputers.

#

MEMORIES AND PERIPHERALS:

PROM PROGRAMMER KIT

The 2708/2704 PROM Programmer Cramerkit just announced by Cramer Electronics, Inc. is a complete package of components, software and design documentation necessary to build a self-contained programmer for the popular 2708 1K x 8 and 2704 512 x 8 PROMs. All timing requirements of the PROM are taken care of by the hardware, allowing the programmer to operate asynchronously with the processor, thereby minimizing the required software.

FLOPPY DISC SYSTEM

CDI has announced an Altair 8800 floppy disc system that is available in kit form. The system provides RS232C entry to any microcomputer and includes the CDI floppy disc operating system.

WIRE-WRAP μ P SOCKET BOARD

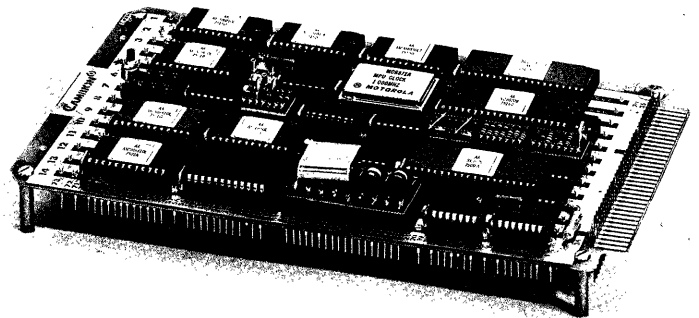

Cambion has introduced the first in a series of support wire-wrap microprocessor socket boards for use with the Motorola M6800 Evaluation Kit. Designated Cambion P/N 787-2000-03-03-00, the board accommodates all of the integrated circuits in the evaluation kit.

Included as part of the pre-wired board is a hand wire-wrap tool, a selection of pre-cut and stripped wire-wrap wire, the edge card connector, standoffs, and mounting hardware. Also included are insertion and withdrawal tools for both widths of integrated circuits (.3 and .6 inches).

Availability is current and unit price is \$197.



PO BOX 1167, CUPERTINO, CA 95014 • (408) 247-8940

Copyright © 1976 by Microcomputer Associates Inc., All Rights Reserved. M.R. Lemas, President. Published monthly. Subscription \$28.00 per year, overseas \$40.00 per year. DARRELL D. CROW, Editor; LILLIAN LAU, Associate Editor; PATRICIA L. DREISBACH, Circulation Editor; RAY HOLT, Applications Technical Advisor; MANNY LEMAS, Applications Technical Advisor.

COMPACT DATA PRINTER

Series EDP1600, a small highly reliable electronic data printer, has just been announced by C-TEK, Inc. The EDP1600 features non-impact electrosensitive print heads instead of the mechanical drums and print wheels normally associated with mechanical printers. An inexpensive means for converting 4-bit binary information to a permanent printed form, the EDP1600 was designed for coincidental print-out with digital display in applications involving digital measuring sets, counters, calculators and computer end units.

The Standard Series EDP1600 prints 16 numeric characters per line from 4-bit binary TTL inputs at up to two lines per second. ASCII alphanumerics are also available. Characters are numeric 5 x 7 dot matrix type.

Single quantity prices start at \$550 and OEM discounts are available. Delivery is stock to 30 days.

MICROCOMPUTER POWER SUPPLY

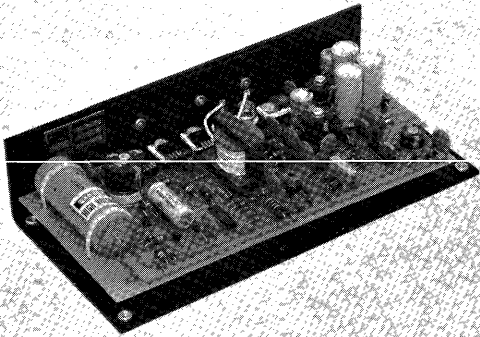

The Boschert Associates' Model 0L80 is a 4 output, 2 lb. switching type power supply designed to power microcomputer systems. The four output voltages are +5V at 10A max, $\pm 12V$ at 2A max and either -9 or -5V at 2A max. Total power output is 80 watts max. The supply has overvoltage, overcurrent and reverse voltage protection.

The supply is priced at \$199 for small quantities and delivery is 30 days ARO.

NEW LSI BUS TRANSCEIVER

Five new devices have been added to Advanced Micro Devices' integrated components line.

They include a pair of high-speed, large scale factory programmable memories designed for computer related systems or to enhance the speed effectiveness of MOS microprocessor designs and a three-part series of LSI bus transceivers for the AM2901 bipolar microprocessor family.

The five memories are the AM9208 512 x 8 ROM; the AM9216 2K x 8 ROM; the AM2905 quad two input bus transceiver with open collector outputs and three-state receivers; the AM2906, a quad two-input bus transceiver with open collector outputs, three-state receivers and a four-bit parity checker/generator; and the AM2907, a quad bus transceiver with open collector outputs, three state receivers and a parity checker/generator. Prices start at \$6.50 to \$25.00 in 100 quantities.

μ C SUPPORT CIRCUITS

Datel Microelectronics has introduced four new circuits for use in microcomputer-based products. They include a \$49 12-bit, 8 μ s A/D converter; a \$24 12-bit, 300 ns D/A converter; a \$16.50 5 μ s, .01% setting time, sample and hold circuit; and a \$5.95 300 ns, 8-bit D/A converter. All prices are for 100 quantity.

HIGH ACCURACY A/D CONVERTERS

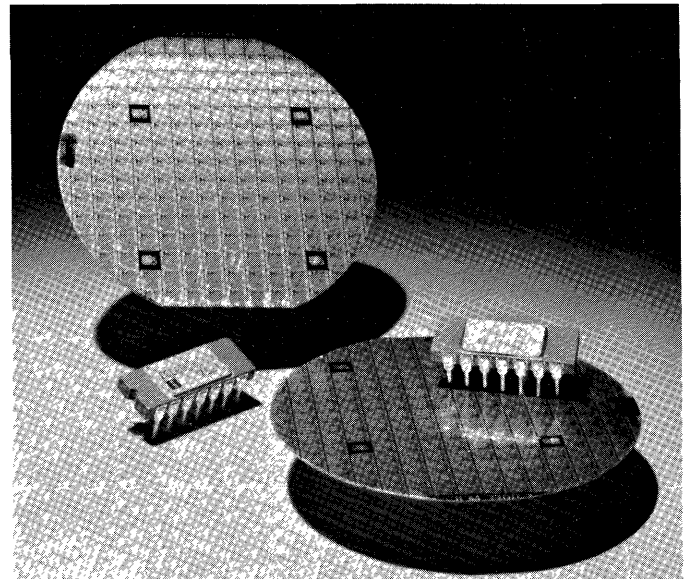

A new two-package microcircuit pair, designated 8052A and 8053A, introduced by Inter-



PO BOX 1167, CUPERTINO, CA 95014 • (408) 247-8940

Copyright © 1976 by Microcomputer Associates Inc., All Rights Reserved. M.R. Lemas, President. Published monthly. Subscription \$28.00 per year, overseas \$40.00 per year. DARRELL D. CROW, Editor; LILLIAN LAU, Associate Editor; PATRICIA L. DREISBACH, Circulation Editor; RAY HOLT, Applications Technical Advisor; MANNY LEMAS, Applications Technical Advisor.

sil, Inc. provides the circuitry for an analog-to-digital converter capable of up to $\pm 40,000$ counts, with a price, according to Intersil, that makes it competitive with $\pm 2,000$ count devices.

The 8052A provides signal conditioning circuits, including buffer amplifier, integrator, comparator and voltage references on chip. The 8053 provides the A/D switch network, plus switch drivers, on chip.

HI-PERFORMANCE 4K RAM

Mostek's latest 4K RAM entry features 200 ns access time and 10% tolerance on all supplies. The new circuit, designated MK 4027, features Schottky-TTL compatibility, memory system performance matching that of 160 ns, 22-pin 4K's because the MK 4027 eliminates the 40 ns delay of the 12V clock driver.

In addition to improved performance characteristics, Mostek's MK 4027 also incorporates direct interfacing capability with TTL, low capacitance inputs and outputs, on-chip address and data registers, two methods of chip selection, and compensates for system timing skews in the column address timing.

Also, the MK 4027 offers a unique cycling operation called page-mode for successive memory operations at multiple column locations at the same row address with increased speed of 135 ns access and decreased power.

The MK 4027 is available in a 16-pin ceramic package and is priced at \$24.20 in 100 quantities.

LOW COST DATA ACQUISITION SYSTEM

A low cost data acquisition module series, designated DATAX-OEM, has been introduced by Data Translation Inc. The new series offers four models, starting at \$130 (in 100s) for the DT 820, an 8-channel, 8-bit resolution module offering a throughput rate of 50 KHz. The top of the line DT835 features a throughput rate of 30 KHz, 16-channels, 10-bit resolution for \$150.

The DT825 has 16 channels, 8-bit resolution and 50 KHz throughput at \$140. The DT830 features 8 channels, 10-bit resolution at a throughput of 30 KHz for \$140.

Each model is a complete D/A system con-

taining an input multiplexer, differential instrumentation amplifier, sample/hold amplifier,

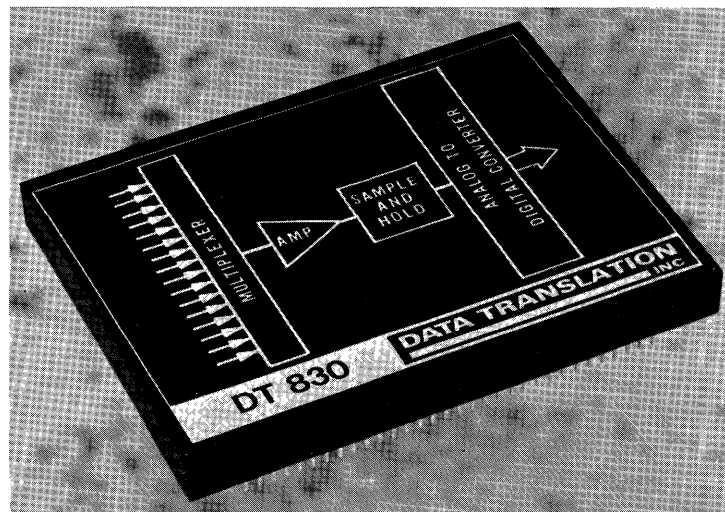

high speed A/D converter, and all control and programming logic. Linearity of all models is $\pm \frac{1}{2}$ LSB, multiplexer operation can be either sequential or random, and analog signals either unipolar or bipolar.

AMD INTRODUCES 4K RAMS

Advanced Micro Devices has announced a new pair of 4K dynamic RAMs. Available in a 22-pin package with separate data input/output circuitry or in an 18-pin version with common data I/O circuitry. AMD says the devices were developed as superior plug-in replacements for similar parts manufactured by Intel and TI as well as others.

Designated the AM9050 (18-pin) and AM9060 (22-pin), these silicon gate MOS memories feature access times to 200 ns and maximum power dissipation of 750 mW. Both devices require only a single clock and all inputs and outputs except clock are TTL compatible.

The RAMs are available for immediate delivery from Hamilton/Avnet, Cramer and Schweizer Electronics. Prices in 100-up quantities begin at \$15.30.

#

If you are not already a subscriber, why not begin so as not to miss any uC news.



PO BOX 1167, CUPERTINO, CA 95014 • (408) 247-8940

Copyright © 1976 by Microcomputer Associates Inc., All Rights Reserved. M.R. Lemas, President. Published monthly. Subscription \$28.00 per year, overseas \$40.00 per year. DARRELL D. CROW, Editor; LILLIAN LAU, Associate Editor; PATRICIA L. DREISBACH, Circulation Editor; RAY HOLT, Applications Technical Advisor; MANNY LEMAS, Applications Technical Advisor.

MOS EQUIVALENTS OF BIPOLAR 1K RAMS

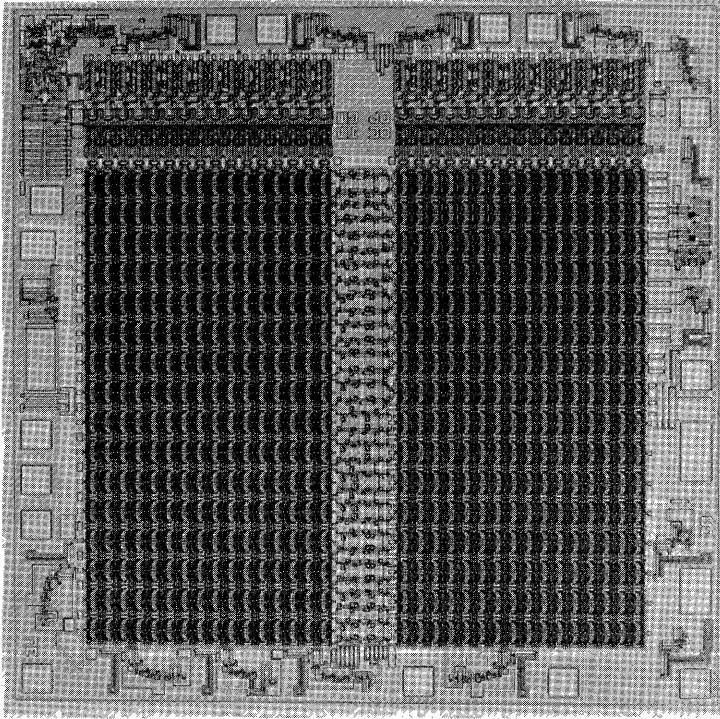

The first MOS equivalents of 1024-bit bipolar high-speed RAMs have been introduced by Intel Corp. The new Intel 2115 and 2125 family can operate as fast as their bipolar counterparts, at the same power supply voltage (+5V) and logic levels. However, they cost less and reduce memory system power dissipation by 35% or more.

The Intel 2115 and 2125 are TTL compatible, pin-for-pin replacements of the 93415 and 93425 1K bipolar RAMs. Both are fully decoded, 16-pin designs. The 2115 has open-collector outputs while the 2125 has three-state outputs.

The family was introduced in two speed grades and a low power version. The -2 devices have a maximum access time of 70 ns while the non-dash memories have access time of 95 ns. The 2115L and 2125L have a maximum current of 65 mA with an access time of 95 ns. Prices begin at \$12.75 for plastic DIPs in 100 quantities.

PEOPLE, LITERATURE AND EVENTS:

OEM MEMORY SYSTEMS

A new business operations center to service OEMs has been formed within the Memory Systems Division of National Semiconductor Corp. Heading the new operation is ROBERT H. WELCH, formerly the director of OEM marketing for the division. Reporting to Welch is a two-man marketing team consisting of DONALD L. MILLER, who becomes director of OEM marketing, and DOUGLAS J. FELDER, who has been named manager of standard product lines.

GI LAUNCHES SUIT AGAINST FAIRCHILD

Citing that Fairchild developed its F-8 microprocessor technology from confidential information obtained from a former employee, General Instrument Corp. filed suit against Fairchild Camera & Instrument Corp. last month.

The suit seeks a permanent injunction against Fairchild's production and sale of the F-8 microprocessor, as well as compensatory and punitive damages.

In its complaint, GI claims that in 1973 Fairchild hired David Chung, former GI manager of microprocessor development programs, who at that time was working on an 8-bit microprocessor system that GI alleges was the source of the F-8. After joining Fairchild, Chung spearheaded its F-8 development program.

CHESAPEAKE MICROCOMPUTER CLUB

John R. Gilchrist of Micro Processors Unlimited and Philip N. Hisley have announced the formation of a new microcomputer club in the Washington D.C.-Baltimore area. The Chesapeake Microcomputer Club has its first meeting in December with over 100 enthusiasts crowding the halls. The club meets every second Wednesday of each month. (301) 667-9690

ONE DAY MICROPROCESSOR COURSE

A one-day short course in microprocessors will be offered by the IEEE on Saturday, March 27, 1976. The session, which will run from 9:00AM to 4:30PM, will be held at the Mecca



PO BOX 1167, CUPERTINO, CA 95014 • (408) 247-8940

Copyright © 1976 by Microcomputer Associates Inc., All Rights Reserved. M.R. Lemas, President. Published monthly. Subscription \$28.00 per year, overseas \$40.00 per year. DARRELL D. CROW, Editor; LILLIAN LAU, Associate Editor; PATRICIA L. DREISBACH, Circulation Editor; RAY HOLT, Applications Technical Advisor; MANNY LEMAS, Applications Technical Advisor.

Exposition Convention Center, Milwaukee WI.

The course will present an overview of microprocessor basic organizations, programming characteristics and hardware availability. Emphasis will be on application in industrial control of data acquisition situations.

The registration fees for IEEE members is \$65, IEEE student members is \$30 and \$75 for non-members. For additional information or registration forms, write: Educational Registrar, IEEE, 445 Hoes Lane, Piscataway NJ 08854.

PEOPLE ON THE MOVE

NORMAN GRANNIS, vice-president and general manager of American Microsystems' Standard Product division has been named corporate vice-president of systems engineering, concentrating on MOS applications for new electronic systems. GEORGE AVERY, vice-president and general manager of AMI's Custom Products division, will now head both the Custom and Standard Product divisions.

ANDREW ALLISON has joined Advanced Micro Devices as MOS microprocessor marketing manager, a new post. Allison was formerly the ROM/PROM marketing manager for Fairchild.

DYNAMIC MEASUREMENTS has franchised Semiconductor Specialists to handle their line of microcomputer power supplies in 11 locations in the mid-U.S. while signing agreements with Harvey Electronics for distribution at five locations in the Northeast.

Fairchild Camera & Instrument Corp. has announced the formation of a new Microsystems Division. The new group, headed by DAVID L. HAHN, former general manager of the Communications Equipment Unit, will have the responsibility for all of Fairchild's microprocessor and microcomputer activities.

Fairchild has also announced several key executive assignments and a restructuring of its semiconductor products organization:

GEORGE D. WELLS has been named vice president and general manager of the Domestic Components Group, consolidating divisions dedicated to semiconductor components and logic devices.

THOMAS A. LONGO has been appointed vice-president and chief technical officer of the corporation. Dr. Longo previously was vice-president and general manager of the Memory

and Logic Group. He will now be responsible for all research and development programs of the company, including the central laboratory, and for technical liaison among its various divisions.

WILLIAM D. BAKER has left Monolithic Memories to become the new group director of microprocessor operations at National Semiconductor.

JAMES MORETON has joined Monolithic Memories Microcomputer Group and will head the firm's effort in microcomputer and small systems that are software-compatible with Data General's Nova series minicomputer.

NEC MICROCOMPUTER, INC. has franchised Harvey Electronics to distribute their microprocessor and memory products in Lexington; Norwalk CT; Woodbury NY and Fairfield NJ. Harvey also handles the Fairchild, Motorola, National, Harris, and Intersil line of microprocessors.

NEC also appointed GEORGE M. WOLFE & ASSOC. to cover sales in the Carolinas.

DONALD A. MITCHELL has been named president and chief operating officer of Plessey, Inc., U.S. subsidiary of the English firm. Mitchell is the former president of Rockwell International's Microelectronics group.

PRO-LOG CORP. has changed their address to 2411 Garden Rd. in Monterey CA.

MICROCOMPUTER ASSOCIATES INC. has relocated to 2589 Scott Blvd., Santa Clara CA.

ROBERT V. KNOX has been appointed vice-president of engineering of the Microelectronic Device division of Rockwell International. After announcing that 1975 saw the shipment of their 1,000,000th microcomputer system, the Microelectronic Device Division announced the appointment of ROBERT BROWNING to the new post of manager, OEM System Marketing. He will be responsible for expansion of the division's sales of MOS/LSI systems and sub-systems as board assemblies.

LARRY HOBBS has been appointed the National Semiconductor product manager at Bell Industries for the San Francisco Bay Area. Hobb's responsibility includes the entire National microprocessor line as well as related products.



PO BOX 1167, CUPERTINO, CA 95014 • (408) 247-8940

Copyright © 1976 by Microcomputer Associates Inc., All Rights Reserved. M.R. Lemas, President. Published monthly. Subscription \$28.00 per year, overseas \$40.00 per year. DARRELL D. CROW, Editor; LILLIAN LAU, Associate Editor; PATRICIA L. DREISBACH, Circulation Editor; RAY HOLT, Applications Technical Advisor; MANNY LEMAS, Applications Technical Advisor.

MICROPROCESSOR STUDY

EDN is offering their second annual Microprocessor Study.

According to EDN, the \$400 report discusses the market potential of microprocessors and related peripherals for the next few years. The study culminates \$20,000 and seven months of intensive research by the publishing company.

RECENT LITERATURE

A rather large number of magazine articles in the past 60 days have concentrated on microprocessors/microcomputers. Rather than just review a few, we have decided to list them.

Advanced Architecture and Applications of Microcomputers. Fred F. Coury, Ken Roghmulder, Barry R. Borgerson, Peter W. J. Verhofstadt, Terry Podendyk, Robert O. Winder, Ann R. Ward. Computer January 1976, page 16.

Bringing Up the PACE μ P—A Detailed Application Story. James L. Tallman. EDN January 20, 1976, page 51.

Designer's Guide to Semiconductor Memories—Part 10. Robert J. Frankenberg. EDN January 20, 1976, page 65.

Modem Uses a Custom-Designed Rather Than Standard Microprocessor. Takashi Mitsutomi. Modern Data January 1976, page 31.

Removable Disk Cartridge Drive—Where It's Come From and Where It's Going. Dan M. Bowers. Modern Data January 1976, page 36.

Experts Tell How To Hold Down High Cost of Processor Programs. Jim Mc Dermott. Electronic Design 26 December 20, 1976, page 20.

Employ μ P Software Tools Properly. David C. Wyland. Electronic Design 26 December 20, 1975, page 50.

Assembly Language for μ Ps. Seymour Levine. Electronic Design 26 December 20, 1975, page 58.

Let a μ P Keep Track of Your Process. John Kaufmann. Electronic Design 26 December 20, 1975, page 66.

Test A/D Converters Digitally by Use of a Microprocessor or Minicomputer and a Simple BASIC Program. Bill Pratt. Electronic Design 25 December 6, 1975, page 86.

Where Are High-Level Languages Headed? 3 Specialists in Industry Give Views. Phil Roybal, Scott McPhillips, Paul Rosenfeld. Electronic Design 25 December 6, 1975, page 47.

The PLA: A Different Kind of ROM. Albert Hemel. Electronic Design 1 January 5, 1976, page 78.

All About Microcomputers. Jules H. Gilder. Computer Decisions December 1975, page 44.

Control Users Speak Out on Microprocessors. E. J. Kompass. Control Engineering December 1975, page 35.

Microcomputer Control: New LSI Chips Make it Practical. S. J. Bailey. Control Engineering December 1975, page 28.

A Microprocessor-Controlled Printer. H. R. Gillette. Modern Data December 1975, page 32.

Do-It-Yourself PROM Programming Simplifies μ P Development Systems. Richard Rosner. EDN January 5, 1976, page 33.

When It Comes to Floppys, There Is Much to Know Before You Buy. Woody Floyd. EDN January 5, 1976, page 18.

Just Getting into Microprocessors? Odds Are You'll End up With a Kit. Edward A. Torrero. Electronic Design 1 January 5, 1976

Incorporate a Calculator Chip, Instead of a Microprocessor. Kurt Skytte. Electronic Design 1 January 5, 1976, page 96.

Base Your IC Tester on a μ P. Jeffrey C. Rise. Electronic Design 1, January 5, 1976, page 88.

Evolution of Microprogrammed Input/Output Processing in One Processor Family. Richard Vahistrom, Max Malone. Computer Design, January 1976, page 98.

Two New Approaches Simplify Testing of Microprocessors. Albert C. L. Chiang, Rick McCaskill. Electronics January 22, 1976.



PO BOX 1167, CUPERTINO, CA 95014 • (408) 247-8940

Copyright © 1976 by Microcomputer Associates Inc., All Rights Reserved. M.R. Lemas, President. Published monthly. Subscription \$28.00 per year, overseas \$40.00 per year. DARRELL D. CROW, Editor; LILLIAN LAU, Associate Editor; PATRICIA L. DREISBACH, Circulation Editor; RAY HOLT, Applications Technical Advisor; MANNY LEMAS, Applications Technical Advisor.

EDUCATION:

MICROCOMPUTER COURSES, SEMINARS, CONFERENCES.
Date, title, cost, location, sponsoring organization

March

- | | | | |
|------|---|-------|---|
| 1 | Microcomputer Profile \$165 Los Angeles CA Technology Service Corp. | 8- 9 | Survey & Application of Microprocessors \$300 Chicago IL Yourdon, Inc. |
| 1 | State of Art in Current Microcomputer Technology \$165 Los Angeles CA Technology Service Corp. | 8-10 | IECI 76 Conference of Industrial Applications of Microprocessors, Process Measurement, and Failure Mode Analysis Philadelphia PA IEEE |
| 1- 5 | Microcomputer Congresses—Intensive Short Courses \$220-\$395 Boston MA Integrated Computer Systems, Inc. | 8-10 | Microprocessors and Microcomputers \$485 New York NY Institute for Science & Public Affairs |
| 2- 4 | Microprocessors & LSI in Telecommunications and Applications \$495 Chicago IL Integrated Computer Systems, Inc. | 8-11 | MCS-80/ICE-80 \$350 Boston MA and Santa Clara CA Intel Corp. |
| 3 | Microcomputer Profile \$165 Chicago IL Technology Service Corp. | 8-12 | Microcomputer Congresses—Intensive Short Courses \$220-\$395 New York NY Integrated Computer Systems, Inc. |
| 3 | PROM Programming—A Systems Approach Free San Jose CA Data I/O Corp. | 9 | Microcomputer Profile \$165 New Carrollton MD Technology Service Corp. |
| 3 | State of Art in Current Microcomputer Technology \$165 Chicago IL Technology Service Corp. | 9 | State of Art in Current Microcomputer Technology \$165 Washington, D.C. Technology Service Corp. |
| 4 | Software Development Techniques for Microcomputers Chicago IL Integrated Computer Systems, Inc. | 9-11 | Compdesign/76 \$120 New York NY Computer Design |
| 4- 6 | ACM Conference on Programming Micro/Minicomputers New Orleans LA Bell Telephone Laboratories | 10 | Basic Microcomputer Theory \$40 Kansas City KS Microcomputer Training Labs |
| 5 | Microcomputer Profile \$165 Ottawa Ontario Technology Service Corp. | 11 | Microcomputer Profile \$165 Dallas TX Technology Service Corp. |
| 5 | State of Art in Current Microcomputer Technology \$165 Ottawa Ontario Technology Service Corp. | 12 | Basic Microcomputer Theory \$40 St. Louis MO Microcomputer Training Labs |
| 8 | Basic Microcomputer Theory \$40 Dallas TX Microcomputer Training Labs | 12-13 | Microcomputer Interfacing Workshop \$175 Reston VA Departments of Chemical Engineering and Chemistry VPI and SU |
| 8 | Microcomputer Profile \$165 Boston MA Technology Service Corp. | 12-13 | Microcomputer Interfacing Workshop Blacksburg VA American Chemical Society |
| 8 | State of Art in Current Microcomputer Technology \$165 Boston MA Technology Service Corp. | 13-15 | Microprocessors and LSI Telecommunications Applications \$495 San Francisco CA Integrated Computer Systems, Inc. |
| 8- 9 | Intel Microprocessors \$225 Mt. View CA Elmar Electronics | 14-19 | Microprocessors and Minicomputers—Interfacing and Applications Blacksburg VA American Chemical Society |
| | | 15 | Adhesives for Industry Conference \$165 San Diego CA Technology Service Corp. |
| | | 15 | Intel S.B.L. Microcomputer \$125 Palo Alto CA Elmar Electronics |



PO BOX 1167, CUPERTINO, CA 95014 • (408) 247-8940

Copyright © 1976 by Microcomputer Associates Inc., All Rights Reserved. M.R. Lemas, President. Published monthly. Subscription \$28.00 per year, overseas \$40.00 per year. DARRELL D. CROW, Editor; LILLIAN LAU, Associate Editor; PATRICIA L. DREISBACH, Circulation Editor; RAY HOLT, Applications Technical Advisor; MANNY LEMAS, Applications Technical Advisor.

- 15 Microcomputer Profile \$165 San Diego CA Technology Service Corp.
- 15-18 MCS-80/ICE-80 \$350 Boston MA Intel Corp.
- 15-26 LSI-11 & PDP-11/03 Hardware and Interfacing \$750 Maynard MA Digital Equipment Corp.
- 16-18 Hands-On Microprocessor Workshop \$495 San Diego CA Wintek Corp.
- 15-17 3000 Bipolar Microcomputer Course \$350 Santa Clara CA Intel Corp.
- 17 Intel S.B.C. Microprocessor \$125 Denver CO Elmar Electronics
- 21-26 Digital Electronics for Automation and Instrumentation Blacksburg VA American Chemical Society
- 22 Basic Microcomputer Theory \$40 Chicago IL Microcomputer Training Labs
- 22-24 3000 Bipolar Microcomputer Course \$350 Boston MA Intel Corp.
- 22-24 Motorola 6800 \$375 Mt. View CA Elmar Electronics
- 22-25 MCS-80/ICE-80 \$350 Santa Clara CA Intel Corp.
- 23-26 Microcomputer Congresses—Intensive Short Courses \$220-\$395 Boston MA Integrated Computer Systems, Inc.
- 24-26 2650 Intensive Design and Applications \$425 Chicago IL Microcomputer Training Labs
- 25 Microcomputer System Hardware \$125 Mt. View CA Elmar Electronics
- 26 Advanced Microprocessor Programming \$125 Mt. View CA Elmar Electronics
- 29-30 Intel Memories \$225 Palo Alto CA Elmar Electronics
- 31- 1 Microprocessors and LSI in Telecommunications Applications \$495 Washington D.C. Integrated Computer Systems, Inc.
- 31- 2 Hands-On Microprocessor Workshop \$495 Florida Wintek Corp.

- 31- 2 Microprocessors and LSI in Telecommunications Applications \$495 Chicago IL Integrated Computer Systems, Inc.

April

- 2 Software Development Techniques for Microcomputers Washington, D.C. Integrated Computer Systems, Inc.
- 3- 4 Laboratory Automation: Micro-, Mini-, or Midicomputers? Chicago IL American Chemical Society
- 5 Basic Microcomputer Theory \$40 Tampa FL Microcomputer Training Labs
- 5- 6 Survey and Application of Microprocessors \$300 San Francisco CA Yourdon Inc.
- 5- 7 Hands-On Microprocessor Workshop \$495 Austria Wintek Corp.
- 5- 8 MCS-80/ICE-80 \$350 Boston MA and Santa Clara CA Intel Corp.
- 5- 9 Microprocessors & Microcomputers: Theory and Applications \$425 Washington D.C. The George Washington University
- 6- 8 Microprocessors and LSI Telecommunications and Applications \$495 Dallas TX Integrated Computer Systems, Inc.
- 7 Basic Microcomputer Training Labs \$40 Atlanta GA Microcomputer Training Labs
- 7 PROM Programming—A Systems Approach Free San Jose CA Data I/O Corp.
- 8 Software Development Techniques for Microcomputers Dallas TX Integrated Computer Systems, Inc.
- 9 Basic Microcomputer Training Labs \$40 Raleigh NC Microcomputer Training Labs
- 12-14 MOS/LSI Logic Design Techniques \$320 Washington, D.C. George Washington University
- 12-14 PL/M \$350 Santa Clara CA Intel Corp.
- 12-16 Microcomputer Congresses—Intensive Short Courses \$220-\$395 Chicago IL Integrated Computer Systems, Inc.



PO BOX 1167, CUPERTINO, CA 95014 • (408) 247-8940

Copyright © 1976 by Microcomputer Associates Inc., All Rights Reserved. M.R. Lemas, President. Published monthly. Subscription \$28.00 per year, overseas \$40.00 per year. DARRELL D. CROW, Editor; LILLIAN LAU, Associate Editor; PATRICIA L. DREISBACH, Circulation Editor; RAY HOLT, Applications Technical Advisor; MANNY LEMAS, Applications Technical Advisor.

- 12-23 LSI-11 & PDP-11/03 Hardware and Interfacing \$750 Maynard MA Digital Equipment Corp.
- 13-14 Microprocessors and LSI Telecommunications and Applications \$425 San Francisco CA Integrated Computer Systems, Inc.
- 13-15 Compdesign/76 \$120 Chicago IL Computer Design Magazine
- 15 Software Development Techniques for Microcomputers San Francisco CA Integrated Computer Systems, Inc.
- 19-21 3000 Bipolar Microcomputer Course \$350 Santa Clara CA Intel Corp.
- 19-22 MCS-80/ICE-80 \$350 Boston MA and Santa Clara CA Intel Corp.
- 19-30 LSI-11 & PDP-11/03 Hardware and Interfacing \$750 Sunnyvale CA Digital Equipment Corp.
- 20-23 Microcomputer Congress—Intensive Short Course \$220-\$395 Washington, D.C. Integrated Computer Systems, Inc.
- 26-28 MCS-4/40 \$350 Santa Clara CA Intel Corp.
- 27-30 Microcomputer Congress—Intensive Short Course \$220-\$395 Chicago IL Integrated Computer Systems, Inc.

SPONSORING ORGANIZATIONS AND CONTACTS

American Chemical Society, Educational Activities Division, 1155 16th St NW, Washington DC 20036

Bell Telephone Laboratories, Lawrence J. Schutte, Rm 6B-302, Naperville IL 60540 (312) 690-2000

Computer Design Magazine, Compdesign/76 Registration, 797 Washington St, Newton MA 02160

Data I/O Corp., 990 E. Arques, Sunnyvale CA 94086 (408) 732-8246

Digital Equipment Corp., Educational Services Dept., 146 Mail St, Maynard MA 01754 (617) 897-5111

Elmar Electronics, 2288 G Charleston Rd., Mt. View CA 94040 (415) 961-2611

George Washington University, Director, Continuing Engineering Education, Washington DC, 20052 (202) 676-6106

IEEE, 5855 Naples Plaza, Suite 301, Long Beach CA 90803 (213) 438-9951

Institute for Science & Public Affairs, 6003 Executive Blvd., Rockville MD 20852 (301) 770-8576

Integrated Computer Systems Inc., 4445 Overland Ave., Culver City CA 90230 (213) 559-9265

Intel Corp., Microcomputer Systems Training, 3065 Bowers Ave., Santa Clara CA 95051 (408) 246-7501

Microcomputer Training Labs, 100 N Winchester Blvd., Suite 260, Santa Clara CA (408) 244-8695

Motorola, P.O. Box 2953, Phoenix AZ 85062 (602) 962-2345

Technology Service Corp., Rob Bowers, 2811 Wilshire Blvd., Santa Monica CA 90403 (213) 829-7411

Wintek Corp., 902 N 9th St, Lafayette IN 47904 (317) 742-6802

Yourdon Inc., 1133 Ave of the Americas, New York NY 10036 (212) 575-0572

FINANCIAL:

EARNINGS

<u>Adv. Memory Systems</u>	<u>1976</u>	<u>1975</u>	<u>%</u>
Dec. 26			
Share Earnings	\$.46	\$.12	+283.3
Earnings	1,160K	306K	+279.1
Sales	9,667K	7,503K	+28.8

<u>Adv. Micro Devices</u>	<u>1976</u>	<u>1975</u>	<u>%</u>
Dec. 28			
Share Earnings	\$.15	----	---
Earnings	397K	-403K	+198.5
Sales	8,908K	6,045K	+47.4
9 Months			
Share Earnings	\$.29	----	---
Earnings	765K	-2,484K	+130.8
Sales	23,751K	19,377K	+22.6



PO BOX 1167, CUPERTINO, CA 95014 • (408) 247-8940

Copyright © 1976 by Microcomputer Associates Inc., All Rights Reserved. M.R. Lemas, President. Published monthly. Subscription \$28.00 per year, overseas \$40.00 per year. DARRELL D. CROW, Editor; LILLIAN LAU, Associate Editor; PATRICIA L. DREISBACH, Circulation Editor; RAY HOLT, Applications Technical Advisor; MANNY LEMAS, Applications Technical Advisor.

<u>Amer. Microsystems</u>	<u>1976</u>	<u>1975</u>	<u>%</u>
Jan. 3			
Share Earnings	----	\$.19	---
Earnings	-1,071K	416K	-357.5
Sales	17,426K	18,365K	-5.1
Year			
Share Earnings	----	\$1.64	---
Earnings	-610K	3,660K	-116.7
Sales	66,070K	75,324K	-12.3

<u>DEC</u>	<u>1976</u>	<u>1975</u>	<u>%</u>
Dec. 27			
Share Earnings	\$1.35	\$.81	+66.7
Earnings	16,274K	9,763K	+66.7
Sales	172,601K	126,837K	+31.1
6 Months			
Share Earnings	\$2.30	\$1.44	+59.7
Earnings	27,664K	17,251K	+60.4
Sales	313,059K	238,590K	+31.2

<u>Electronic Arrays</u>	<u>1976</u>	<u>1975</u>	<u>%</u>
Dec. 31			
Share Earnings	\$.01	\$.01	---
Earnings	16,000	23,000	-30.4
Sales	4,220K	3,327K	+26.8
9 Months			
Share Earnings	\$.14	\$.52	-73.1
Earnings	252K	893K	-71.8
Sales	11,754K	12,781K	-8.0

<u>Fairchild C & I</u>	<u>1976</u>	<u>1975</u>	<u>%</u>
Dec. 28			
Share Earnings	\$.21	\$.79	-73.4
Earnings	1,165K	4,129K	-71.8
Sales	81,368K	78,891K	
Year			
Share Earnings	\$2.41	\$5.00	-51.8
Earnings	13,073K	27,032K	-51.6
Sales	291,542K	384,933K	-24.3

<u>General Instrument</u>	<u>1976</u>	<u>1975</u>	<u>%</u>
Nov. 30			
Share Earnings	\$.25	\$.56	-55.4
Earnings	2,164K	4,410K	-50.9
Sales	163,508K	106,398K	-2.7
9 Months			
Share Earnings	\$.49	\$1.52	-67.8
Earnings	4,664K	12,018K	-61.2
Sales	288,913K	332,956K	-13.2

<u>Harris Corp.</u>	<u>1976</u>	<u>1975</u>	<u>%</u>
Dec. 31			
Share Earnings	\$1.08	----	---
Earnings	6,565K	-12,211K	+153.8
Sales	125,314K	121,496K	+3.1
6 Months			
Share Earnings	\$2.05	\$1.62	+26.5
Earnings	12,416K	8,490K	+46.2
Sales	243,974K	228,625K	+6.7

<u>Intel Corp.</u>	<u>1976</u>	<u>1975</u>	<u>%</u>
Dec. 31			
Share Earnings	\$.66	\$.44	+50.0
Earnings	4,599K	2,997K	+53.5
Sales	40,253K	31,284K	+28.7
Year			
Share Earnings	\$2.35	\$2.96	-20.6
Earnings	16,274K	19,776K	-17.7
Sales	136,788K	134,456K	+1.7

<u>Mostek Corp.</u>	<u>1976</u>	<u>1975</u>	<u>%</u>
Dec. 31			
Share Earnings	\$.02	\$.05	-60.0
Earnings	62K	211K	-70.6
Sales	3,723K	3,949K	-5.7
Year			
Share Earnings	----	\$.98	---
Earnings	-1,238K	3,894K	-131.8
Sales	47,119K	60,060K	-21.5

<u>Motorola</u>	<u>1976</u>	<u>1975</u>	<u>%</u>
Dec. 31			
Share Earnings	\$.43	\$.15	+186.7
Earnings	12,140K	4,199K	+189.1
Sales	356,006K	325,210K	+9.5
Year			
Share Earnings	\$1.46	\$2.52	-42.1
Earnings	41,127K	70,728K	+41.9
Sales	1,311M	1,367M	-4.1

<u>Nat'l Semiconductor</u>	<u>1976</u>	<u>1975</u>	<u>%</u>
Dec. 14			
Share Earnings	\$.43	\$.32	+34.4
Earnings	5,659K	3,827K	+47.9
Sales	79,894K	55,061K	+45.1
6 Months			
Share Earnings	\$.83	\$.77	+7.8
Earnings	10,900K	9,333K	+16.8
Sales	162,280K	130,181K	+24.7



PO BOX 1167, CUPERTINO, CA 95014 • (408) 247-8940

Copyright © 1976 by Microcomputer Associates Inc., All Rights Reserved. M.R. Lemas, President. Published monthly. Subscription \$28.00 per year, overseas \$40.00 per year. DARRELL D. CROW, Editor; LILLIAN LAU, Associate Editor; PATRICIA L. DREISBACH, Circulation Editor; RAY HOLT, Applications Technical Advisor; MANNY LEMAS, Applications Technical Advisor.

<u>Plessey Co.</u>	<u>1976</u>	<u>1975</u>	<u>%</u>
Dec. 31			
Share Earnings	\$.42	\$.53	-20.8
Earnings	7,900K	10,000K	-21.0
Sales	252,000K	219,200K	+15.0
9 Months			
Share Earnings	\$1.34	\$1.71	-21.6
Earnings	25,100K	32,000K	-21.6
Sales	696,900K	642,200K	+8.5

<u>RCA Corp.</u>	<u>1976</u>	<u>1975</u>	<u>%</u>
Dec. 31			
Share Earnings	\$.43	\$.21	+104.8
Earnings	33,400K	16,600K	+101.2
Sales	1,339M	1,218M	+9.9
Year			
Share Earnings	\$1.40	\$1.45	-3.4
Earnings	110,000K	113,300K	-2.9
Sales	4,804M	4,626M	+3.8

<u>Texas Instruments</u>	<u>1976</u>	<u>1975</u>	<u>%</u>
Dec. 31			
Share Earnings	\$.91	\$.92	-1.1
Earnings	20,783K	21,092K	-1.5
Sales	390,942K	418,705K	-6.6
Year			
Share Earnings	\$2.71	\$3.92	-30.9
Earnings	62,142K	89,621K	-30.6
Sales	1,367M	1,572M	-13.0

Advanced Micro Devices, Inc, 901 Thompson Pl,
Sunnyvale CA 94086 (408) 732-2400

AES Data, Ltd, 570 McCaffrey St, Montreal Que
Canada N4T 1N1 (514) 739-2711

Allied Leisure Products, Hialeah FL 33000
(305) 558-5200

Applied Data Communications, 1509 E McFadden
Ave, Santa Ana CA 92705 (714) 547-6954

Automated Computer Systems, 2361 E Foothill
Blvd, Pasadena CA 91107 (213) 792-1193

Boschert Associates, 1031 E Duane, Suite C,
Sunnyvale CA 94086 (408) 732-2441

Cambion Division, Cambridge Thermonie Corp,
445 Concord Ave, Cambridge MA 02138 (617)
491-5400

CDI, Westlake Village CA 91360

Chesapeake Microcomputer Club, 236 St David
Ct, Cockeysville MD 21030 (301) 667-9690

Computer Transmission Corp, 2352 Utah Ave,
El Segundo CA 90245 (213) 973-2222

Cramer Electronics, 85 Wells Ave, Newton MA
02159 (617) 969-7700

C-Tek, Inc, 4 Railroad Ave, Wakefield MA
01880 (617) 246-1720

Data Translation Inc, 109G Concord St, Fram-
ingham MA 01701 (617) 879-3595

Data Works Instrumentation, 9748 Cozycroft
Ave, Chatsworth CA 91311 (213) 998-8985

Datel Microelectronics, Division of Datel
Systems, Inc, 1020 Turnpike St, Canton MA
02021 (617) 828-8000

Digital Equipment Corp, One Iron Way, Marl-
boro MA 01752 (617) 897-5111

Digital Laboratories, 377 Putnam Ave, Cam-
bridge MA 02139 (617) 876-6220

EDN Magazine, Cahners Publishing Co, 205 E
42nd St, New York NY 10017 (212) 689-3250

Essex International Semiconductor Group, 564
Alpha Dr, Pittsburgh PA 15238 (412) 782-0200

Extel Corp, 310 Anthony Trail, Northbrook IL
60062 (312) 564-2600

Fairchild Camera & Instrument, 464 Ellis St,
Mt View CA 94040 (415) 962-5011

FBE, Seattle WA 98100

First Data Corp, Waltham MA 02154 (617)
890-6701

Forth Inc, Manhattan Beach CA 90266 (213)
372-8493

General Computer/Systems Inc, Addison TX 75001
(214) 233-5800

General Instrument Corp, Microelectronics,
600 W John St, Hicksville NY 11802 (516)
733-3000

Intel Corp, 3065 Bowers Ave, Santa Clara CA
95051 (408) 246-7501

Interface Technology, 852 N Cummings Rd, Co-
vina CA 91724 (213) 966-1718



PO BOX 1167, CUPERTINO, CA 95014 • (408) 247-8940

Copyright © 1976 by Microcomputer Associates Inc., All Rights Reserved. M.R. Lemas, President. Published monthly. Subscription \$28.00 per year, overseas \$40.00 per year. DARRELL D. CROW, Editor; LILLIAN LAU, Associate Editor; PATRICIA L. DREISBACH, Circulation Editor; RAY HOLT, Applications Technical Advisor; MANNY LEMAS, Applications Technical Advisor.

Intermetrics, 701 Concord Ave, Cambridge MA
02138 (617) 661-1840

Intersil, 10900 N Tantau Ave, Cupertino CA
95014 (408) 257-5450

Logic Systems, 437-A Aldo Ave, Santa Clara CA
95050 (408) 244-2412

MI² Data Systems, 930 Kinnear, Columbus OH
43200 (614) 481-8881

Microcomputer Associates Inc, 2589 Scott Blvd,
Santa Clara CA 95050 (408) 247-8940

Micro Systems Software, 355 W Olive, Sunny-
vale CA 94086 (408) 735-1650

Mostek Corp, 1215 W Crosby Rd, Carrollton TX
75006 (214) 242-0444

MSI Data Corp, 340 Fischer Ave, Costa Mesa CA
92627 (714) 549-6000

National Semiconductor Corp, 2900 Semiconduc-
tor Dr, Santa Clara CA 95051 (408) 732-5000

NEC Microcomputers, Inc, 5 Militia Dr, Lex-
ington MA 02173 (617) 862-6410

Processor Applications, Ltd, 2801 E Valley
View Ave, West Covina CA 91792 (213) 965-8865

Rockwell International, 3370 Miraloma Ave,
Anaheim CA 92803 (213) 647-5000

Siemens Corp, 3 Computer Dr, Cherry Hill NJ
08002 (609) 424-2400

Sycor Inc, 100 Phoenix Dr, Ann Arbor MI 48104
(313) 971-0900

Tenney Engineering, Inc, 1090 Springfield Rd,
Union NJ 07083 (201) 686-7870

Texas Instruments, PO Box 5012, Dallas TX
75222 (214) 238-2011

University Computing Co, 7200 Stemmons Free-
way, Dallas TX 75247 (214) 637-5010

Wintek Corp, 902 N 9th St, Lafayette IN 47904
(317) 742-6802

Wyle Computer Products, Wyle Laboratories,
3200 Margruder Blvd, Hampton VA 23666 (804)
838-0122

**Software Consultant — Intel 8080 Specialist L.
John Postas (408) 244-3381.**

PAPER TAPE DUPLICATING

Let us do your paper tape duplicating for you. Com-
puter controlled duplication and verification of 8
channel fan fold paper tape. Fast turnaround,
guaranteed accuracy and low cost. Free pickup and
delivery for large orders. Call us about any paper
tape punching requirements. Also paper tape to
cards.

SHEPARDSON MICROSYSTEMS

10601 S. Saratoga/Sunnyvale Rd., Suite 302, Cupertino, Ca. 95014

(408) 257-2996

MICROCOMPUTER CONCEPTS, INC.

Custom hardware and software development for
PACE, IMP016, SCAMP, 6800

10683 Cranks Rd. (213) 836-2271
Culver City, California 90230

*** MICROPROCESSOR DESIGN *** SUPPORT

We specialize in transforming your micro-
processor design into operating hardware.

Particular emphasis on high density CPU
circuit board design. We also provide com-
plete package design and drafting support.

For further information write:

Contemporary Designs, 370 Rose St., Danville, Ca. 94526
or Call: (415) 837-3778

Is This YOUR COPY of MICROCOMPUTER DIGEST?

If not, make sure you receive your own regular copy each month by
subscribing today.

Yes! Start sending me MICROCOMPUTER DIGEST every
month.

- 1 year @ \$28 (for overseas, add \$12)
 Bill my company. Bill me.
 Payment enclosed.
 Subscription Renewal

Name _____ Title _____

Company _____

Address _____

City/State/Zip _____

Business Phone () _____



PO BOX 1167, CUPERTINO, CA 95014 • (408) 247-8940

Copyright © 1976 by Microcomputer Associates Inc., All Rights Reserved. M.R. Lemas, President. Published monthly. Subscription \$28.00 per year, overseas \$40.00 per year. DARRELL D. CROW, Editor; LILLIAN LAU, Associate Editor; PATRICIA L. DREISBACH, Circulation Editor; RAY HOLT, Applications Technical Advisor; MANNY LEMAS, Applications Technical Advisor.

FOR THE
intel
SBC 80/10

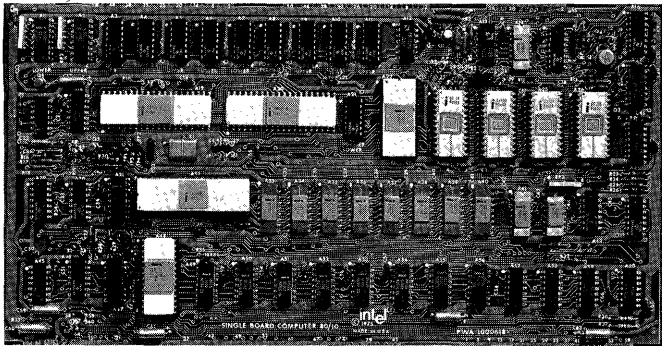

CALL

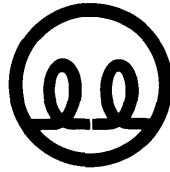

ELMAR ELECTRONICS
WYLE DISTRIBUTION GROUP

2288 Charleston Road • Mt. View, CA 94040
Phone: (415) 961-3611 • TWX: 910-379-6437

THE LOWEST-COST COMPUTER
SYSTEM SOLUTION FOR
OEM APPLICATIONS
WITH CPU, MEMORY,
PROGRAMMABLE SERIAL
AND PARALLEL I/O....ALL ON A

SINGLE
printed circuit board

VISIT
OR
CALL

BILL SCHARRENBERG

FOR APPLICATIONS INFORMATION
AT THE FULL CAPABILITY CENTER
OF



WYLE DISTRIBUTION GROUP

ELMAR ELECTRONICS
Mountain View, California
(415) 961-3611

ELMAR ELECTRONICS/ARIZONA
Phoenix, Arizona
(602) 257-1272

MICROCOMPUTER DIGEST

Bulk Rate
Permit No. 243
Cupertino, CA
95014

PO BOX 1167, CUPERTINO, CA 95014 • (408) 247-8940

A MICROCOMPUTER CARD THAT MAKES SENSE

SINGLE CARD MICROCOMPUTER SYSTEM

- 8 BIT MICROPROCESSOR (SEE BELOW)
- CRYSTAL-CLOCK CONTROLLED
- 1K × 8 STATIC RAM
- 2K × 8 PROM or 4K × 8 MASK ROM SOCKETS
- 24-32 BIDIRECTIONAL I/O LINES
- INTERRUPTS
- DMA CAPABILITY
- POWER-ON AUTO START
- FULL TEMPERATURE RANGE (0° TO 70° C)
- SMALL SIZE (LESS THAN 30 SQ. INCHES)
4.25" × 7" P.C. CARD
- ASSEMBLED AND TESTED

8080A
OEM

6502
OEM

A CARD NEVER BEFORE EQUALLED HIGHEST PERFORMANCE PER SQ. INCH

YOUR CHOICE OF
MICROPROCESSORS

- 8080A
- 6502
- 6800
- 2650

PICK THE ONE THAT
BEST FITS YOUR
OEM APPLICATION

IF YOU ARE ONE OF THE FIRST 10
TO COMMIT TO 100 OR MORE CARDS
YOUR PRICE IS

\$275

(NORMALLY \$295, 100 QTY.)

OFFER EXPIRES JUNE 1, 1976

6800
OEM



Microcomputer Associates Inc.
2589 Scott Blvd. Santa Clara, CA 95050 (408) 247-8940

2650
OEM