

PREPARED BY: <i>Masahiro Tanaka</i> DATE: 2012.4.2	  DISPLAY DEVICE BUSINESS GROUP SHARP CORPORATION <b>SPECIFICATION</b>	SPEC No. LCY-12004
APPROVED BY: <i>Shi Tanaka</i> DATE: 2012.4.2		FILE No.
		ISSUE: March. 30. 2012
		PAGE : 19 pages

DEVICE SPECIFICATION FOR  
  
**TFT - LCD module**  
  
 MODEL No. LQ050T5DW03

CUSTOMER'S APPROVAL

DATE \_\_\_\_\_

BY \_\_\_\_\_

DATE \_\_\_\_\_

BY \_\_\_\_\_

PRESENTED

BY *T. Makii* \_\_\_\_\_

Makii Toshiyuki  
 DEPARTMENT GENERAL MANAGER  
 DEVELOPMENT DEPARTMENT II  
 DISPLAY DEVICE DIVISION II  
 DISPLAY DEVICE BUSINESS GROUP  
 SHARP CORPORATION



## NOTICE

This publication is the proprietary of Sharp Corporation (hereinafter referred to as SHARP) and is copyrighted, with all rights reserved. Under the copyright laws, no part of this publication may be reproduced or transmitted in any form or by any means, electronic or mechanical for any purpose, in whole or in part, without the express written permission of SHARP. Express written permission is also required before any use of this publication may be made by a third party.

The application circuit examples in this publication are provided to explain the representative applications of SHARP's devices and are not intended to guarantee any circuit design or permit any industrial property right or other rights to be executed. SHARP takes no responsibility for any problems related to any industrial property right or a third party resulting from the use of SHARP's devices, except for those resulting directly from device manufacturing processes.

In the absence of confirmation by device specification sheets, SHARP takes no responsibility for any defects that occur in equipment using any of SHARP's devices, shown in catalogs, data books, etc. Contact SHARP in order to obtain the latest device specification sheets before using any SHARP's device.

SHARP reserves the right to make changes in the specifications, characteristics, data, materials, structures and other contents described herein at any time without notice in order to improve design or reliability. Contact SHARP in order to obtain the latest specification sheets before using any SHARP's device. Manufacturing locations are also subject to change without notice.

Observe the following points when using any device in this publication. SHARP takes no responsibility for damage caused by improper use of the devices.

The devices in this publication are designed for use in general electronic equipment designs, such as:

- Car Navigation system
- Automotive auxiliary information display
- Automotive audio visual equipment

The appropriate design measures should be taken to ensure reliability and safety when SHARP's devices are used for equipment such as:

- Transportation control and safety equipment (i.e. aircraft, trains, automobiles, etc.)
- Traffic signals
- Gas leakage sensor breakers
- Alarm equipment
- Various safety devices etc.

SHARP's devices shall not be used for equipment that requires extremely high level of reliability, such as:

- Military and space applications
- Nuclear power control equipment
- Medical equipment for life support

Contact a SHARP representative, in advance, when intending to use SHARP's devices for any "specific" applications other than those recommended by SHARP.

Contact and consult with a SHARP representative if there are any questions about the contents of this publication.

1. General

The product covered herein is an amorphous-silicon TFT (Thin Film Transistor) color LCD (Liquid Crystal Display) module of active matrix type and with a panel aspect ratio of 15 : 9.

2. Features

- 5.0 " screen with a panel aspect ratio of 15:9, which makes the module suitable for use in wide-screen systems and produces a high resolution image that is composed of 96,000 pixels elements in a stripe arrangement.
- Graphics and texts can be displayed on a 400×240×RGB dots panel with 262,144 colors by supplying 18 bit data signals(6 bit/color).
- Wide viewing angle technology is employed.
- Active matrix drive system allowing high-contrast images to be produced
- Reduced reflection as a result of low reflection black matrix and an antiglare (AG) polarizer being adopted.
- COG bonding technology used for a thin, lightweight and compact module
- Realized a high quality picture of the natural color appearance by adopting Normally Black Mode panel which is superior concerning the color appearance.
- LED backlight

3. Module Components and Outline

The module comprises of a TFT LCD panel, drivers, PCB, a front case, and a backlight. (backlight operating circuit is not included.)

4.Mechanical Specification

Table 4-1

Parameter	Specification	Units	Remarks
Screen size (Diagonal)	12.6 [5.0"]	cm	
Active Area	108.0 (W) x 64.8 (H)	mm	
Display Format	400 x 240 x RGB	Dots	
Dot Pitch	0.270 (W) x 0.090 (H)	mm	
Pixel Configuration	RGB Stripe Configuration		
Display Mode	Normally Black		
Outline Dimension	124.0 (W) x 80.0(H) x 6.5 (D)	mm	【Note 4-1,2】
Mass	135 MAX	g	【Note 4-1】

【Note 4-1】 TYP values are given.

【Note 4-2】 FPC (LED) ,PCB (Mounted parts) ,PCB Fixing Hook are not included.

## 5. Input terminal

## 5-1) TFT-LCD panel driving part

Table 5-1

Pin No.	Symbol	Description	Remarks
1	GND	Ground	
2	DCLK	Clock signal for system driver.	
3	GND	Ground	
4	B0	BLUE data signal(LSB)	
5	B1	BLUE data signal	
6	B2	BLUE data signal	
7	B3	BLUE data signal	
8	B4	BLUE data signal	
9	B5	BLUE data signal(MSB)	
10	GND	Ground	
11	G0	GREEN data signal(LSB)	
12	G1	GREEN data signal	
13	G2	GREEN data signal	
14	G3	GREEN data signal	
15	G4	GREEN data signal	
16	G5	GREEN data signal(MSB)	
17	GND	Ground	
18	R0	RED data signal(LSB)	
19	R1	RED data signal	
20	R2	RED data signal	
21	R3	RED data signal	
22	R4	RED data signal	
23	R5	RED data signal(MSB)	
24	GND	Ground	
25	SHUT	Control signal for Power supply.	※
26	GND	Ground	
27	HSY	Horizontal synchronous signal (Low active)	
28	VSY	Vertical synchronous signal (Low active)	
29	N.C.	to be used it as "OPEN"	
30	GND	Ground	
31	GND	Ground	
32	N.C.	to be used it as "OPEN"	
33	VCC	Power supply for LCD module	
34	VCC	Power supply for LCD module	
35	VCC	Power supply for LCD module	
36	VCC	Power supply for LCD module	
37	N.C.	This is open terminal	
38	GND	Ground	
39	GND	Ground	
40	GND	Ground	

※Please refer to Chapter 9, Power Supply sequence

Recommend FPC:0.5mmPitch 40pin (connector:FH12 40Pin,made by HIROSE ELECTRIC CO.,LTD)

5-2)LED backlight driving part

Table 5-2

Pin No.	Symbol	Function	Remarks
1	A1	LED Anode side 1	
2	A2	LED Anode side 2	
3	N.C.	OPEN	
4	C1	LED Cathode side 1	
5	C2	LED Cathode side 2	
6	N.C.	OPEN	
7	Themistor(+)	OPEN /Function prepared	Themistor not mounted
8	Themistor(-)	OPEN /Function prepared	Themistor not mounted

Recommend connector:AVX/6288 8pin

Ref.(Below) Circuit diagram in LED back light

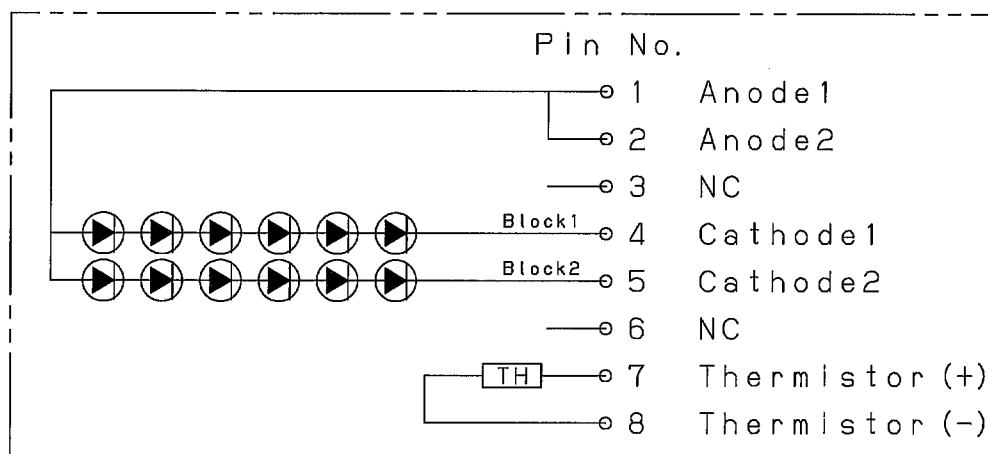

6. Absolute maximum ratings

Table 6

GND=0V

Item	Symbol	MIN.	MAX.	Unit	Remarks
Power supply Voltage	VCC	-0.3	4.0	V	
Input Signal Voltage	VID	-0.3	VCC+0.3	V	【Note 6-1】
Storage Temperature	T stg	-40	+90	°C	【Note 6-2,3】
Operating Temperature (Panel temperature)	T opr1	-30	+85	°C	【Note 6-4】

【Note 6-1】 R0~R5, G0~G5, B0~B5, DCLK, HSY, VSY, SHUT

【Note 6-2】 This rating applies to all parts of the module and should not be exceeded.

【Note 6-3】 Maximum wet-bulb temperature is 57°C. Condensation of dew must be avoided as electrical current leaks will occur, causing a degradation of performance specifications.

【Note 6-4】 The operating temperature is a temperature at which the module is assured to operate. Display quality criteria such as contrast and response speed are evaluated when Ta = +25°C.

7. Electrical Characteristics

7-1) TFT LCD panel driving section

Table 7-1

GND=0V, Ta=+25°C

Item	Symbol	MIN.	TYP.	MAX.	Unit	Remarks	
Power Supply voltage	Voltage Range	VCC	+3.1	+3.3	+3.6	V	
	Rise time	Trise	—	—	10	ms	【Note 7-3】
	Voltage Fall	VTH	2.5	—	—	V	【Note 7-3,4】
	Voltage drop time	Tvth	—	—	10	ms	【Note 7-3】
	Resupply voltage	Voff	0	—	0.1Vcc	V	【Note 7-4】
	Time of re-power supply	Tpon	100	—	—	ms	【Note 7-4】
Input signal voltage	Hi	V IHS	0.7×VCC	—	VCC	V	【Note 7-1】
	Lo	V ILS	GND	—	0.3×VCC	V	
Input current 1	Hi	IHS1	—	—	1.0	μ A	【Note 7-2】
	Lo	ILS1	-1.0	—	—	μ A	
Input current 2	Hi	IHS2	—	—	1.0	μ A	HSY/VSY
	Lo	ILS2	-30	—	—	μ A	
Input current 3	Hi	IHS3	—	—	30	μ A	SHUT
	Lo	ILS3	-1.0	—	—	μ A	

【Note 7-1】 : DCLK, HSY, VSY, SHUT, R0~R5, G0~G5, B0~B5

【Note 7-2】 : DCLK, R0~R5, G0~G5, B0~B5

【Note 7-3】 : Please refer to Fig.7-1

【Note 7-4】 : If VCC becomes lower than VTH, Power supply is to be put again.

After getting VCC to GND level, the sequence of Power supply “ON” should be executed after 100 ms passed. (Please refer to Fig.7-2)

Fig.7-1 : Vcc Waveform

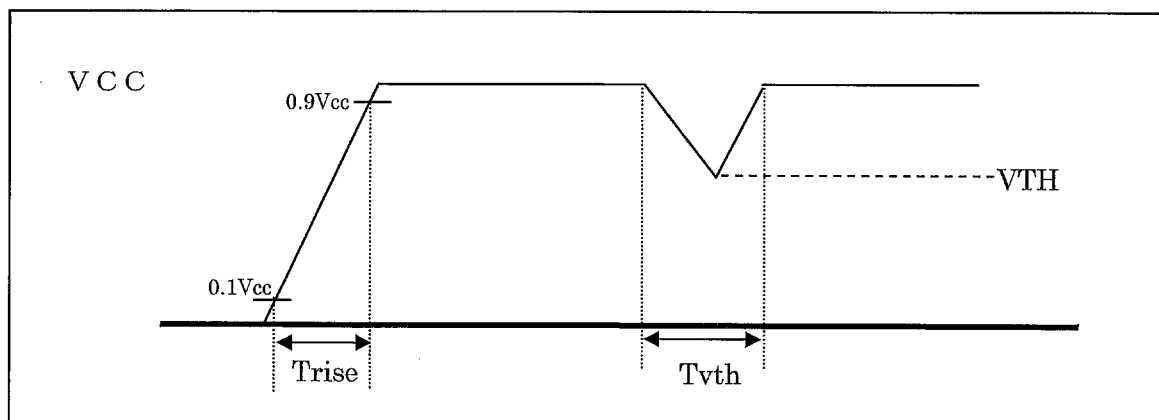
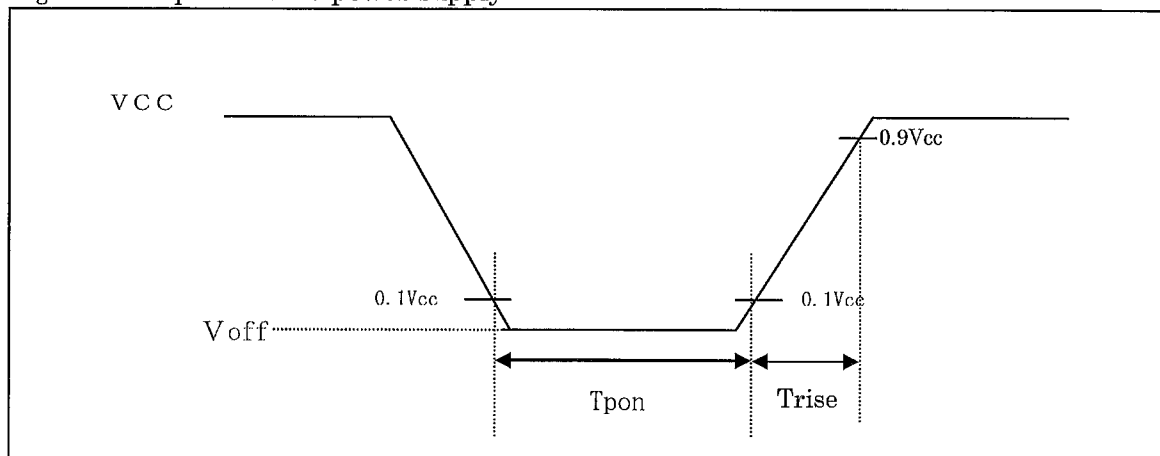

Fig.7-2 : Sequence of re-power supply



## 7-2) Backlight driving section

Table 7-2

Ta = +25°C

Item	Symbol	MIN.	TYP.	MAX.	Unit	Remarks
LED Voltage	Vf	16.7	18.8	21.4	V	6 LEDs, 1 line IF=70mA
LED Current	If	—	70	80	mA	
Power consumption	Wf	—	2.6	—	W	Vf×If×2line
LED Voltage (-30°C)	Vf (-30)	—	—	22.7	V	Tp=-30°C,IF=70mA
LED Voltage (+85°C)	Vf (+85)	16.1	—	—	V	Tp=+85°C,IF=70mA
PWMDimmingFrequency	Fpwm	420	—	—	Hz	

## 8. Input signal timing characteristics

Table 8

Item		Symbol	MIN	TYP	MAX	Unit	Remarks
DCLK	Clock frequency	fCLK	6.33	6.67	7.0	MHz	1/(1/fV/tV/tH)
	Clock pulse high duty	fWCH	40	—	60	%	
	Clock pulse low duty	fWCL	40	—	60	%	
	Rise time	fCR	—	—	20	%	
	Fall time	fCF	—	—	20	%	
Data	Set up time	tDS	10	—	—	ns	Applied to R0- R5/G0-G5/B0-B5
	Hold Time	tDH	10	—	—	ns	
HSY signal (HSY)	Cycle(time)	tH(t)	61.43	64.47	67.93	us	1/fV/tV
	Cycle(Clock)	tH(clk)	—	430	—	clk	
	frequency	fH	14.72	15.51	16.28	kHz	1/tH
	Pulse Duration	tHPW	—	10	—	clk	
	Set up time	tHS	10	—	—	ns	
	Hold time	tHH	10	—	—	ns	
VSY Signal (VSY)	Cycle	tV	—	260	—	line	
	frequency	fV	56.62	59.66	62.61	Hz	
	Pulse Duration	tVPW	2	2	—	line	
Horizontal Display period		tHA	—	400	—	clk	
Horizontal display starting position (Horizontal back porch)		tHBP	—	20	—	clk	
Horizontal front porch		tHFP	—	10	—	clk	
HSY-VSY phase difference		tHV	0	0	3	clk	
Vertical display period		tVA	—	240	—	line	
Vertical display starting position (Vertical back porch)		tVBP	—	6	—	line	
Vertical front porch		tVFP	—	14	—	line	



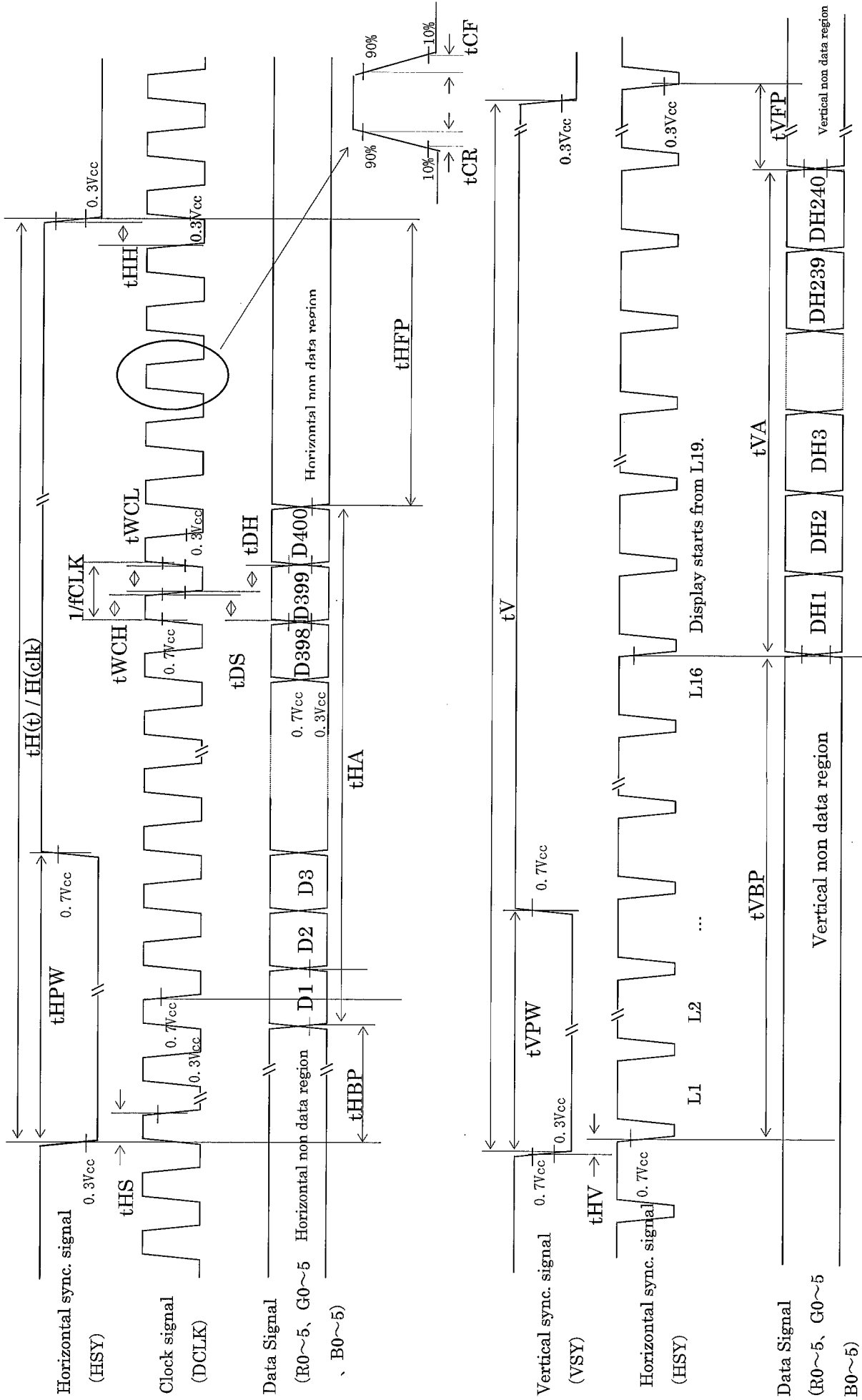

Fig. 8 Timing char

9.Power On/Off sequence

Figure 9 : Power On/Off sequence

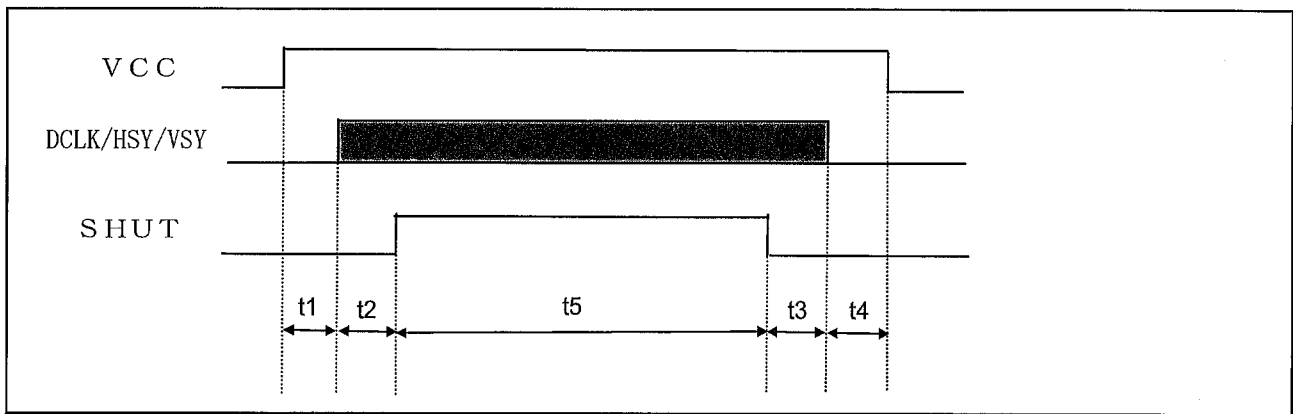

Table 9: Power On/Off sequence spec

Symbol	MIN	TYP	MAX	Unit
t1	10	—	—	ms
t2	0	—	—	ms
t3	10	—	—	frame
t4	0	—	—	ms
t5	9	—	—	frame

9-1. Power on sequence

Figure 9-1 / table 9 shows "Power On Sequence".

The input signal should be keep "t1" and "t2" after Vcc turn on. Then, it starts to display in 7 vertical period

after counting the falling edge of VSY pulse.

Figure 9-1 : Power on sequence

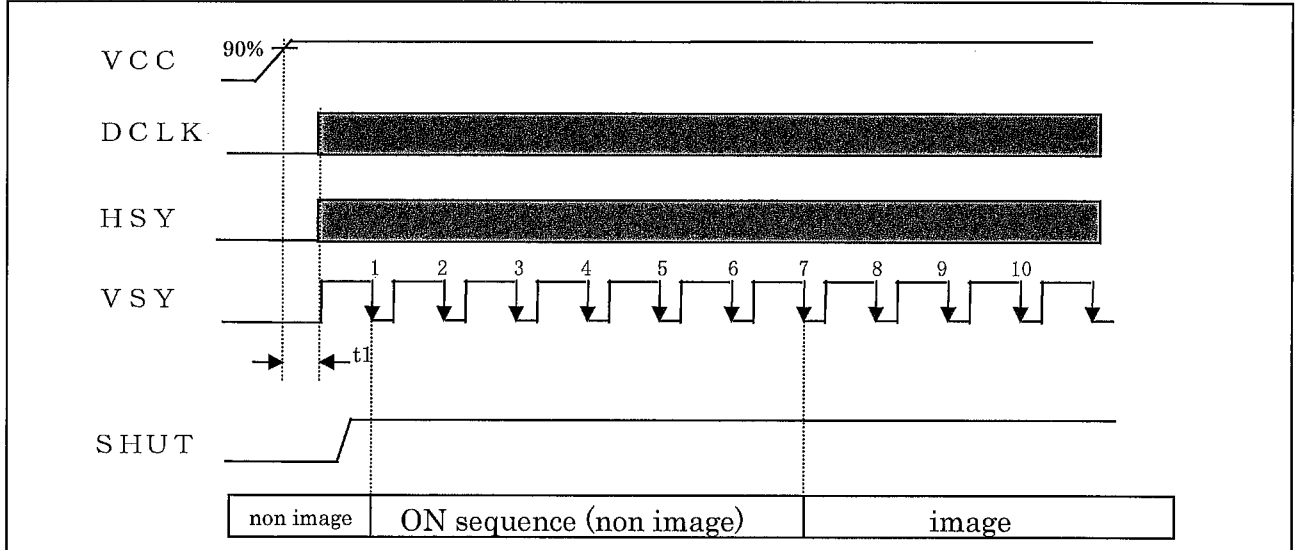

Table 9-1 : Power On sequence spec

Item	Symbol	MIN	TYP	MAX	Unit
Vcc input signal time	t1	10	—	—	ms

Note : The "Shut signal" should be Hi during "Power on sequence" - No-mage in the Figure 9-1.

9-2. Power Off sequence

Below figure9-2 shows “Power Off sequence”. “Power Off sequence” will start when SHUT signal changes to Lo-level from Hi level during normal operation. Display changes to “no image” in 6 vertical period SHUT signal changes to Lo-level.

Figure 9-2 : Power Off sequence

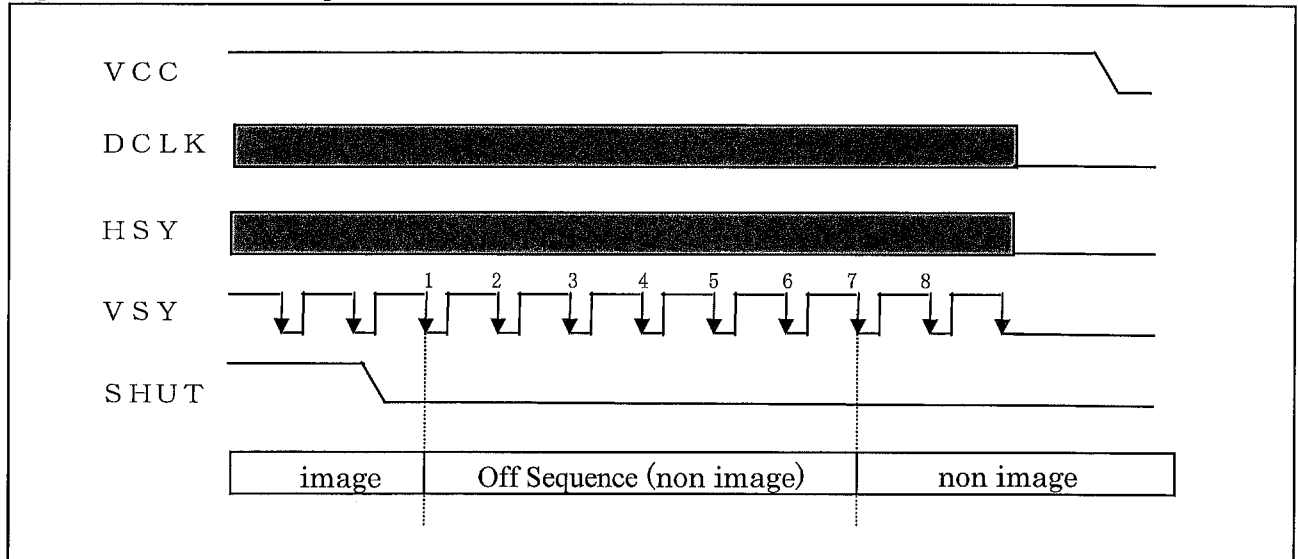

Note : The “SHUT signal” should be Lo during “Power off sequence” - No-image in the Figure 9-2.

Note : During the power off sequence, please keep the input signal on.

10. Current Consumption

Table 10 shows the specification of current consumption.

Table 10

Ta= 25 °C

Item	Symbol	Vcc Condition	Min	Typ	Max	Unit	Remarks
Vcc current	IVCC	VCC=+3.3V	—	9	25	mA	

\* (Measurement condition) :

Display pattern / : White pattern

Driving Condition :

fCLK=6.67MHz、fH=15.51kHz、fV=59.66Hz

definition )

fH : Horizontal Sync.(HSY) Frequency fH=1/tH(t)

fV : Vertical Sync.(VSY) Frequency fV=1/(tH(t)\*tV)

11. Input Data Signals and Display Position on the screen

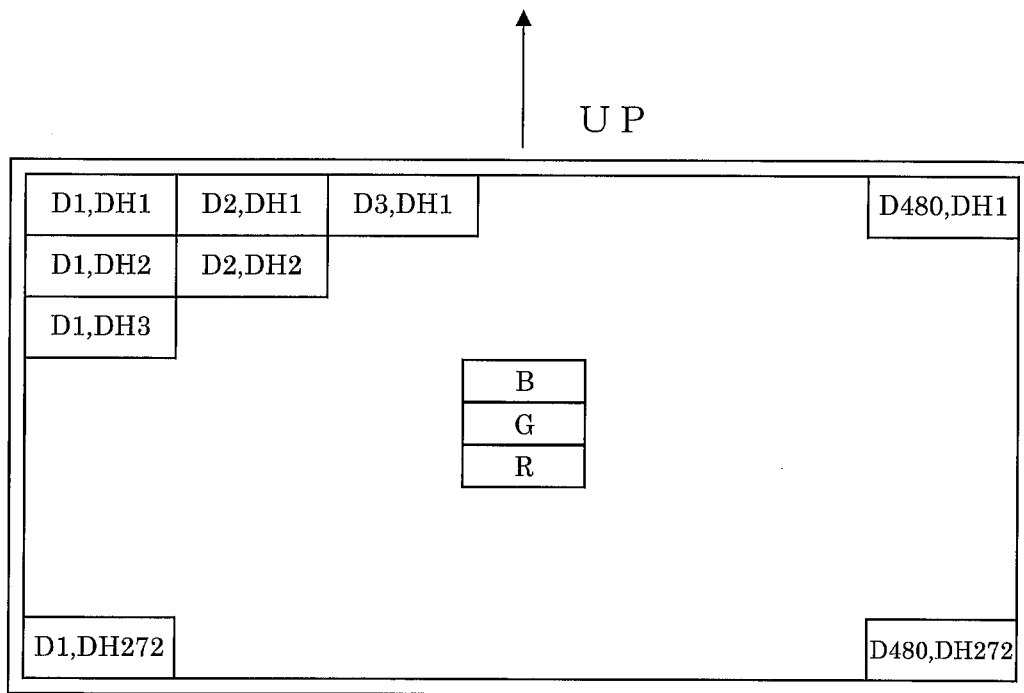

Display position of input data (H,V)

12. Input Signals, Basic Display Color and Gray Scale of Each Color

Colors & Gray scale	Gray Scale	Data signal																		
		R0	R1	R2	R3	R4	R5	G0	G1	G2	G3	G4	G5	B0	B1	B2	B3	B4	B5	
Basic color	Black	—	0	0	0	0	0	0	0	0	0	0	0	0	0	0	0	0	0	0
	Blue	—	0	0	0	0	0	0	0	0	0	0	0	0	1	1	1	1	1	1
	Green	—	0	0	0	0	0	0	1	1	1	1	1	1	0	0	0	0	0	0
	Cyan	—	0	0	0	0	0	0	1	1	1	1	1	1	1	1	1	1	1	1
	Red	—	1	1	1	1	1	1	0	0	0	0	0	0	0	0	0	0	0	0
	Magenta	—	1	1	1	1	1	1	0	0	0	0	0	0	1	1	1	1	1	1
	Yellow	—	1	1	1	1	1	1	1	1	1	1	1	1	0	0	0	0	0	0
	White	—	1	1	1	1	1	1	1	1	1	1	1	1	1	1	1	1	1	1
Gray Scale of red	Black	GS0	0	0	0	0	0	0	0	0	0	0	0	0	0	0	0	0	0	0
	↑	GS1	1	0	0	0	0	0	0	0	0	0	0	0	0	0	0	0	0	0
	Darker	GS2	0	1	0	0	0	0	0	0	0	0	0	0	0	0	0	0	0	0
	↑	↓			↓					↓					↓					
	↓	↓			↓					↓					↓					
	Brighter	GS61	1	0	1	1	1	1	0	0	0	0	0	0	0	0	0	0	0	0
	↓	GS62	0	1	1	1	1	1	0	0	0	0	0	0	0	0	0	0	0	0
	Red	GS63	1	1	1	1	1	1	0	0	0	0	0	0	0	0	0	0	0	0
Gray Scale of green	Black	GS0	0	0	0	0	0	0	0	0	0	0	0	0	0	0	0	0	0	0
	↑	GS1	0	0	0	0	0	0	1	0	0	0	0	0	0	0	0	0	0	0
	Darker	GS2	0	0	0	0	0	0	0	1	0	0	0	0	0	0	0	0	0	0
	↑	↓			↓					↓					↓					
	↓	↓			↓					↓					↓					
	Brighter	GS61	0	0	0	0	0	0	1	0	1	1	1	1	0	0	0	0	0	0
	↓	GS62	0	0	0	0	0	0	0	1	1	1	1	1	0	0	0	0	0	0
	Green	GS63	0	0	0	0	0	0	1	1	1	1	1	1	0	0	0	0	0	0
Gray Scale of blue	Black	GS0	0	0	0	0	0	0	0	0	0	0	0	0	0	0	0	0	0	0
	↑	GS1	0	0	0	0	0	0	0	0	0	0	0	0	1	0	0	0	0	0
	Darker	GS2	0	0	0	0	0	0	0	0	0	0	0	0	0	1	0	0	0	0
	↑	↓			↓					↓					↓					
	↓	↓			↓					↓					↓					
	Brighter	GS61	0	0	0	0	0	0	0	0	0	0	0	0	1	0	1	1	1	1
	↓	GS62	0	0	0	0	0	0	0	0	0	0	0	0	0	1	1	1	1	1
	Bleu	GS63	0	0	0	0	0	0	0	0	0	0	0	0	1	1	1	1	1	1

Each basic color can be displayed in 64 gray scales from 6 bit data signals. According to the combination of total 18 bit data signals, the 262,144-color display can be achieved on the screen.

13.Optical characteristics

Table 13

(Initial Value) Ta=25°C

Parameter	Symbol	Condition	Min	Typ	Max	Unit	Remarks
Viewing angle range	$\theta 21, \theta 22$	$CR \geq 200$	35	45	—	°(degree)	【Note 13-1,2】
	$\theta 11$		35	45	—	°(degree)	
	$\theta 12$		35	45	—	°(degree)	
Contrast ratio	CRmax.	$\theta = 0^\circ$	500	1200	—		【Note 13-2】
Response time	Rise	$\theta = 0^\circ$	—	15	30	ms	【Note 13-3】
	Fall		—	10	20	ms	
Luminance $\theta 0\phi 0$	Y	If=70mA	525	700	—	cd/m <sup>2</sup>	【Note 13-4】
White Luminance	x	If=70mA	0.245	0.285	0.325		【Note 13-4】
	y		0.265	0.305	0.345		
Red Chromaticity	x		0.595	0.635	0.675		
	y		0.287	0.327	0.367		
Green Chromaticity	x		0.272	0.312	0.352		
	y		0.548	0.588	0.628		
Blue Chromaticity	x		0.107	0.147	0.187		
	y		0.036	0.076	0.116		
LED Life time	—	continuation	10,000	—	—	hour	【Note 13-5】

\*Measuring after 30minutes operation. The measurement of the optical character is measured by using the method of fig.13-1 and fig.13-2 under the condition which is equal to the darkroom or the darkroom.

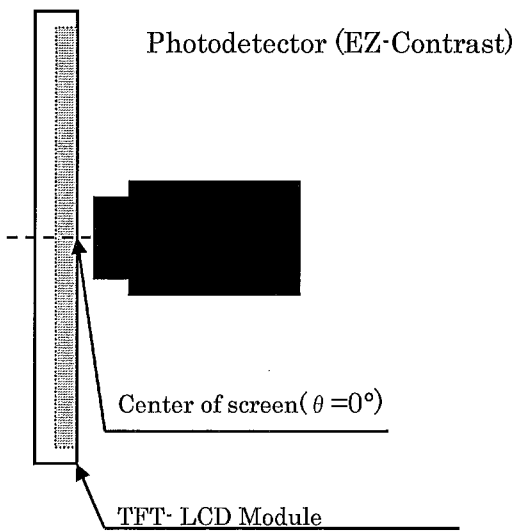

Fig13-1 Viewing angle range / Response time measurement method

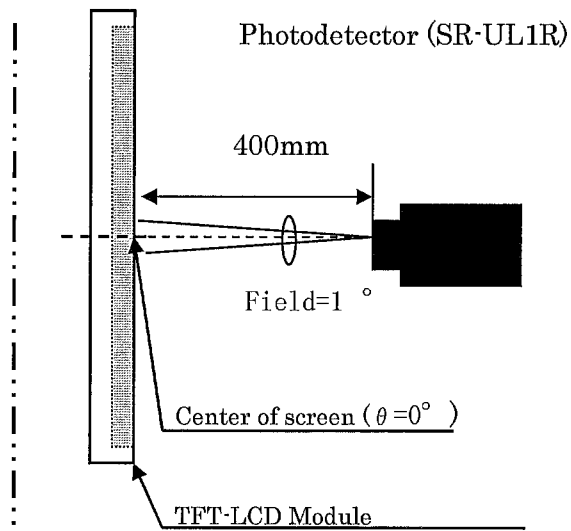
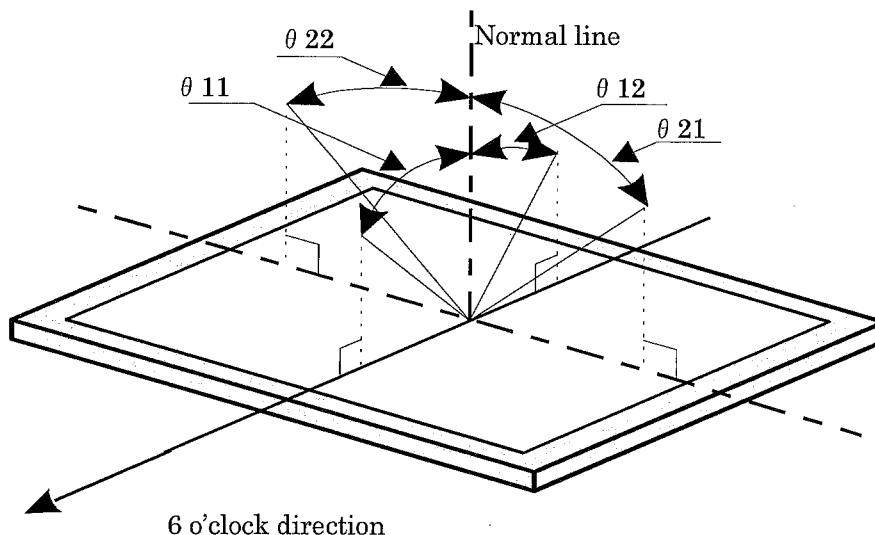

Fig13-2 Luminance / Chromaticity / Contrast measurement method

【Note 13-1】 Viewing angle range is defined as follows.



【Note 13-2】 Contrast ratio of transmission is defined as follows:

$$\text{Contrast ratio(CR)} = \frac{\text{Photo detector output with LCD being "white"(GS63)}}{\text{Photo detector output with LCD being "black"(GS0)}}$$

【Note 13-3】 Response time is obtained by measuring the transition time of photo detector output, when input signals are applied so as to make the area "black" to and from "white".

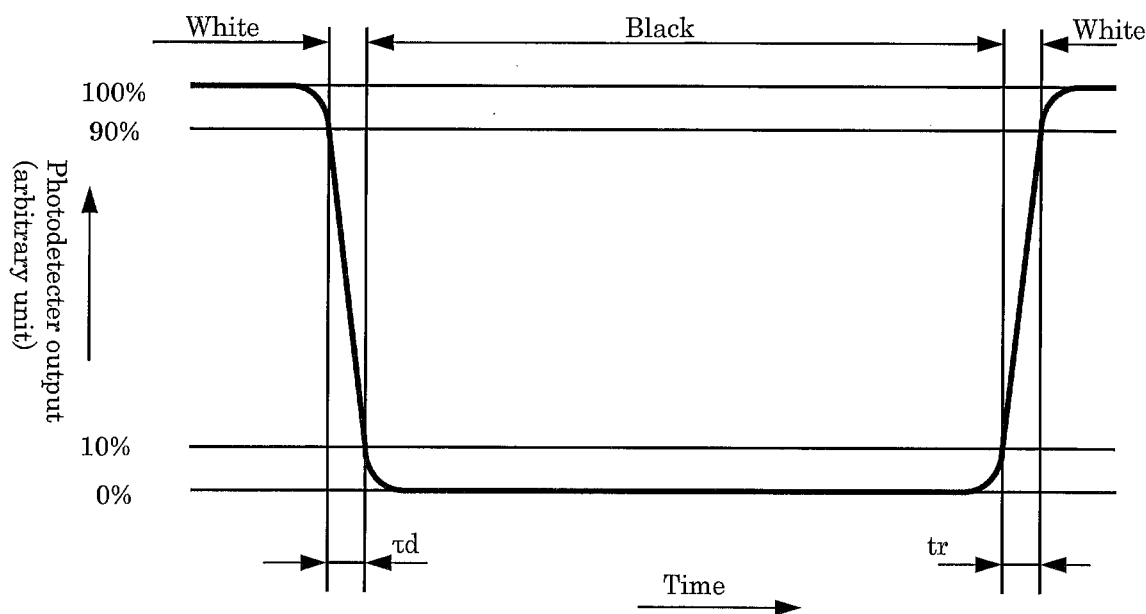

【Note 13-4】 Measured on the center area of the panel at a viewing cone 1° by TOPCON luminance meter SR-UL1R.(After 30 minutes operation)

【Note 13-5】 LED life time is defined as the time when the brightness of the panel not to become less than 50% of the original value in the continuous operation under the condition of LED current I f=70mA .

#### 14. Display quality

The display quality of the color TFT-LCD module shall be in compliance with the Incoming Inspection Standard.

#### 15. Mechanical characteristics

##### 15-1) External appearance

Appearance of the active area only is guaranteed. (See Fig.1: Outline dimensions)

#### 16. Handling instructions

##### 16-1) Handling of LCD-FPC,LED-FPC

- ① Please do not hang a LCD module or do not apply excessive power for LCD-FPC,LED-FPC.
- ② Please do not fold the LCD-FPC or LED-FPC. Please follow Sharp's FPC handling recommendations for bending the LCD-FPC & LED-FPC and under all circumstances ensure the minimum bend radius guideline of (0.5) mm is observed.

##### 16-2) Mounting of module

- ① Please take care during the assembly process to ensure the to TFT-LCD module is not twisted or warped.  
Don't reach the pressure of touch-switches of the set side to a module directly , because images may be disturbed
- ② Please power off the system before connecting the input/output connector.

##### 16-3) Precautions in mounting

Polarizer which is made of soft material and susceptible to damage and must be handled carefully. Protective sheet covers the surface to protect it against scratches and dirties. It is recommended to keep a protective sheet (Including alternative protective sheet attached by the customer & agreed with Sharp in advance) during assembly and remove immediately before use by end customer, taking care of static electricity.

Precautions in peeling off protective sheet.

#### A) Working environment

When the protective sheet is peeled off, static electricity may cause dust to stick to the polarizer surface.

To avoid this, the optimised environment is:

- a) Floor: Conductive treatment of  $1M\Omega$  or more on the tile.  
(conductive mat or conductive paint on the tile)
- b) Clean room free from dust and with an adhesive mat on the doorway.
- c) Humidity: 50%~70%    Temperature:  $15^{\circ}\text{C}\sim 27^{\circ}\text{C}$
- d) Workers shall wear conductive shoes, conductive work clothes, conductive gloves and an earth band.

#### B) Working procedures

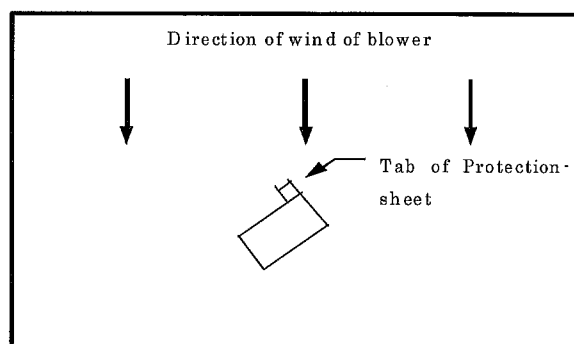
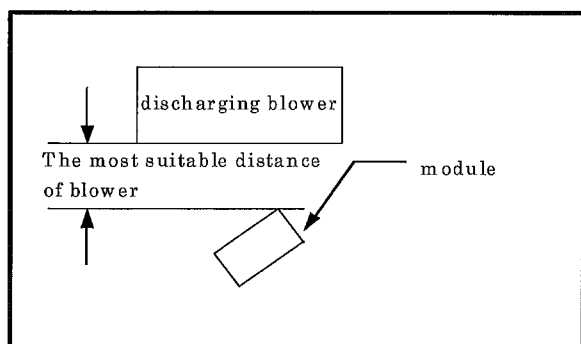

- a) Direct the air of discharging blower somewhat downward to ensure that module is in the



flow of this air.

Please set the distance between module and discharging blower the most suitable distance of blower.

- b) Peel off protective sheet, pulling adhesive tape slowly to your side.  
(5 seconds or more peel off time is necessary when the discharging blower is not present)
- c) After peeling off the protective sheet, immediately pass the module to the next work process to prevent the module to get dust.
- d) Method of removing dust from polarizer
  - Blow off dust with N2 blower for which static electricity preventive measure has been taken.
  - Since polarizer is vulnerable, wiping should be avoided if possible.  
When removal of stain or grease is necessary, we recommend to use adhesive tape to softly remove them from the panel.

When metal part of the TFT-LCD module (shielding case) is soiled, wipe it with soft dry cloth. For stubborn dirties, wipe the part, breathing on it.

Wipe off water drop or finger grease immediately. Long contact with water may cause discoloration or spots on the polarizer.

TFT-LCD module uses glass which breaks or cracks easily if dropped or bumped on hard surface. Handle with care. Since CMOS LSI is used in this module, take care of static electricity and earth your body when handling.

#### 16-4) Product design guidelines

Sharp recommends strict adherence to the following system product design guidelines.

- Protection of the LCD module against water & salt-water by a waterproof cover.
- Please take measures to ensure interference radiation from the module, does not interfere with surrounding appliances.
- Ensure exposed electrical components and contacts are electronically protected by implementing necessary insulation in the system by following good design practices for the system.

#### 16-5) Others

- ① Do not expose the module to direct sunlight or intensive ultraviolet rays for several hours; liquid crystal is deteriorated by ultraviolet rays.
- ② Store the module at a temperature near the room temperature. At lower than the rated storage temperature, liquid crystal solidifies, causing the panel to be damaged. At higher than the rated storage temperature, liquid crystal turns into isotropic liquid and may not recover.
- ③ If LCD panel breaks, there may be a possibility that the liquid crystal escapes from the panel. Since the liquid crystal is poisonous, do not put it into the eyes or mouth. When liquid crystal sticks to hands, feet or clothes, wash it out immediately with soap.
- ④ Reference information (Handling procedures) available from Sharp on request detail additional guidance and procedures for handling a display which should be followed.

17. Packing form

17-1) The packing form figure: See Fig.2

17-2) Carton handling & storage:

a) Piling number of cartons : MAX 10

b) Conditions for storage

Environment

① Temperature : 0~40°C

② Humidity : 60%RH or less (at 40°C)

Avoid dew condensation at low temperature and high humidity.

③ Atmosphere : Avoid harmful gases & liquids, such as acid or alkali which corrode electronic components and/or wires, must not be detected.

④ Period : about 3 months

⑤ Opening of the package : In order to prevent the LCD module from breakdown by electrostatic charges, please control the room humidity over 50%RH and open the package taking sufficient countermeasures against electrostatic charges, such as earth strape etc.

18. Others

18-1) Indication of lot number

The lot number is shown on a label. Attached location is shown in Fig.1(Outline Dimensions).

Indicated contents of the label

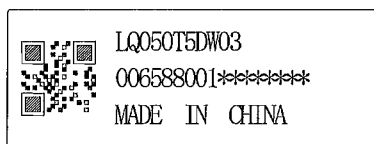

contents of lot No.

the 1st figure production year (ex. 2010 : 10)

the 2nd figure production month 1,2,3,.....,9,X,Y,Z

the 3rd~8th figure serial No. 000001~

the 9 th figure revision marks A,B,C...

18-2) About RoHS

This TFT-LCD module corresponds to the RoHS..

18-3) The country of origin of the TFT-LCD module.

China

18-4) Description of the country of origin on the carton.

MADE IN CHINA

19. Reliability Test Conditions for TFT-LCD Module

No.	Test items	Test conditions
1	High temperature storage test	Ta= +90°C 240h
2	Low temperature storage test	Ta= -40°C 240h
3	High temperature and high humidity operating test	Tp=+60°C 90%RH 240h
4	High temperature operating test	Tp= +85°C 240h
5	Low temperature operating test	Ta= -30°C 240h
6	Electro static discharge test	±200V · 200pF(0Ω) 1 time for each terminals
7	Shock test	980m/s <sup>2</sup> · 6ms, ±X ; ±Y ; ±Z 3 times for each direction
8	Vibration test	Frequency range : 8~33.3Hz, Stroke : 1.3mm Frequency range : 33.3Hz~400Hz, Acceleration : 29.4m/s <sup>2</sup> Sweep cycle : 15 minutes X,Z 2 hours for each directions, 4 hours for Y direction 【Note.16-1】 (total 8 hours)
9	Heat shock test	Ta= -30°C ~ +85°C , 200 cycles (0.5h) (0.5h)

\* Ta= Ambient temperature, Tp= Panel temperature

【Check items】 In the standard condition, there shall be no practical problems that may affect the display function.

【Note.16-1】 X,Y,Z directions are shown as follows:

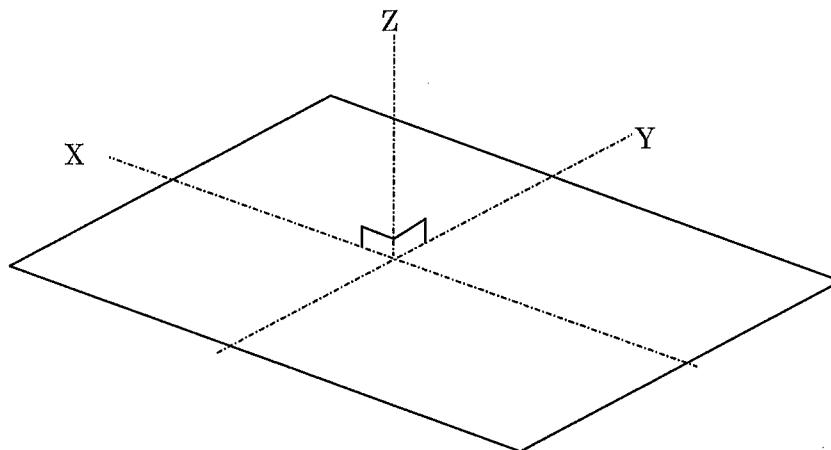



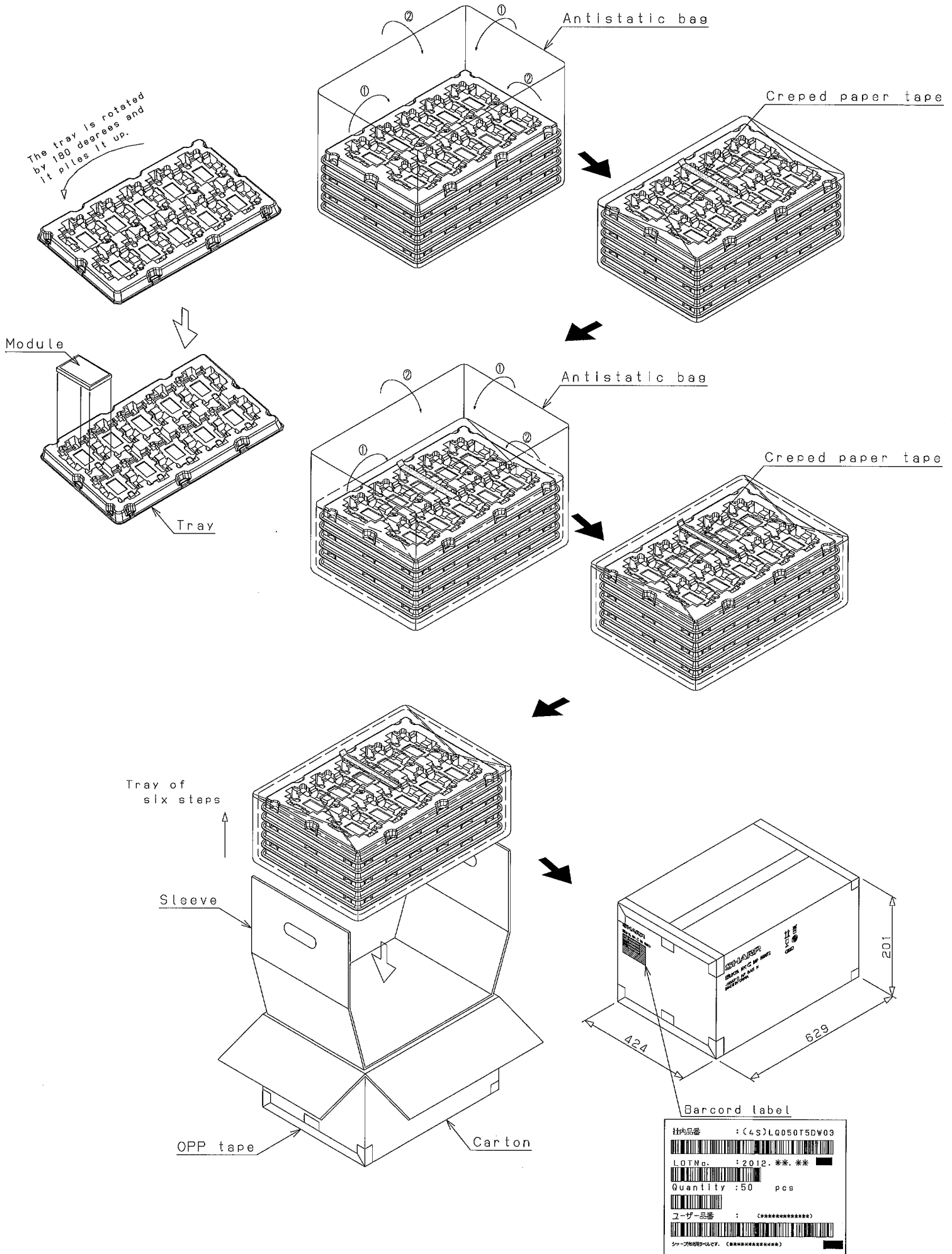

Fig.3 Packing form

\*The carton:Up to 10steps.  
 \*Carton size:629x424x201 (H)  
 \*Max 50modules in each carton