

# AJ 9631-S OPERATOR'S MANUAL

Modem Model Designation: 9631-S  
FCC Registration Number: ADH9Z0-16238-MDE  
Ringer Equivalence: 0.8

## NOTICE

The material in this manual is for informational purposes and is subject to change without notice. Anderson Jacobson shall not be liable for errors contained herein or for incidental or consequential damages in connection with the furnishing, performance or use of this material.

This document contains proprietary information which is protected by copyright. All rights are reserved. No part of this document may be photocopied without prior written consent of Anderson Jacobson, Inc.



## COMMERCIAL PRODUCTS WARRANTY

AJ equipment, excluding software, is warranted to be free from defects in material and workmanship during the Warranty Period, beginning on the date of shipment or installation by AJ. AJ's liability is limited to repair or replacement of defective Equipment, at AJ's option.

### Warranty Period:

a) new couplers and modems	one year;	Zone 1 = 0 - 50 miles from AJ service center
b) new terminals, professional computers and peripherals	90 days;	Zone 2 = 51 - 75 miles from AJ service center
c) used couplers and modems	180 days;	Zone 3 = 76 - 100 miles from AJ service center
d) refurbished Equipment	30 days.	

### New Couplers/Modems (0-1200 bps), Used Couplers/Modems and Refurbished Equipment

Defective 0-1200 bps couplers/modems, used couplers/modems and refurbished Equipment must be returned; transportation prepaid, to an AJ service center, properly packed, insured, accompanied by proof of purchase and a statement of the problem. Customer must contact an AJ service office for shipping and packing instructions.

### New Modems (> 1200 bps)

- During the first thirty days of the warranty period, AJ will provide on-site warranty service at Zone 1 locations. For locations in Zones 2 and 3, Customer may request on-site warranty service and pay AJ's transportation expenses and hourly rate for travel required beyond Zone 1. After the first thirty days, Customer must return defective modems as described in paragraph b) or may pay an additional charge for on-site warranty service during the remainder of the warranty period.
- Customer may also elect to return defective modems to an AJ service center at any time during the warranty period. Modems must be shipped transportation prepaid, properly packed, insured, accompanied by proof of purchase and a statement of the problem. Customer must contact an AJ service office for shipping and packing instructions.

### New Terminals, Professional Computers and Peripherals

- AJ will provide on-site warranty service for new terminals, professional computers and peripherals at Zone 1 locations. For locations in Zones 2 and 3, Customer may request on-site warranty service and pay AJ's transportation expenses and hourly rate for travel required beyond Zone 1.
- Customer may also elect to return defective new terminals, professional computers and peripherals to an AJ service center, transportation prepaid, properly packed, insured, accompanied by proof of purchase and a statement of the problem. Customer must contact an AJ service office for shipping and packing instructions.

### Software

Software is licensed and warranted under the terms of the AJ SOFTWARE LICENSE AGREEMENT, incorporated into this Warranty by reference.

These warranties do not apply to Equipment that, in AJ's judgment, has been subject to: a) accident; b) neglect; c) misapplication; d) an unsuitable installation environment; e) attachment of incompatible accessories or devices; f) alteration or reconfiguration; or g) improper installation or maintenance by other than authorized AJ personnel.

**THESE WARRANTIES ARE IN LIEU OF ALL OTHER WARRANTIES, EXPRESS OR IMPLIED, INCLUDING THE IMPLIED WARRANTIES OF MERCHANTABILITY AND FITNESS FOR A PARTICULAR PURPOSE. SOME STATES MAY NOT ALLOW LIMITATIONS ON IMPLIED WARRANTY, SO THE ABOVE LIMITATION MAY NOT APPLY TO YOU.**

**LIMITATION OF LIABILITY — IN NO EVENT SHALL AJ BE LIABLE FOR LOSS OF USE, LOSS OF PROFITS, ADDITIONAL COST SUBSTITUTE EQUIPMENT, INCIDENTAL, SPECIAL OR CONSEQUENTIAL DAMAGES. ANY ACTION AGAINST AJ MUST BE COMMENCED WITHIN ONE YEAR FROM THE DATE THE CAUSE OF ACTION ACCURES. SOME STATES DO NOT ALLOW THE EXCLUSION OR LIMITATION OF INCIDENTAL OR CONSEQUENTIAL DAMAGES, SO THE ABOVE LIMITATION OR EXCLUSION MAY NOT APPLY TO YOU.**

AJMA 081084-CMW

ANDERSON JACOBSON, INC.

521 Charcot Avenue San Jose, California 95131 (408) 435-8520

## FCC INFORMATION AND REQUIREMENTS

### Part 15 Advisement - Class A computing Device:

This equipment generates, uses, and can radiate radio frequency energy and if not installed and used in accordance with the instruction manual, may cause interference to radio communications. It has been tested and found to comply with the limits for a Class A computing device pursuant to Subpart J of Part 15 of FCC Rules, which are designed to provide reasonable protection against such interference when operated in a commercial environment. Operation of this equipment in a residential area is likely to cause interference, in which case the user at his own expense will be required to take whatever measures may be required to correct the interference.

### Part 68 Specific Interconnection Requirements and Advisements:

1. The Federal Communications commission (FCC) has established Rules which permit the modem to be directly connected to the telephone network. A jack is provided by the telephone company; jacks for this type of customer-provided equipment will not be provided on party lines or coin lines.
2. If the modem is malfunctioning, it may cause damage to the telephone network. The user should disconnect the modem until the source of the problem has been determined and repaired. The user is under threat of disconnection by the phone company if the above procedure is not carried out.
3. The telephone company is required to give adequate notice of any changes it may make to its technical operations and procedures, as they may affect the use or compatibility of the modem or telephone.

### Notification Information:

4. The telephone company must be notified and provided with the following information before installation of the modem is to take place. (The telephone company should also be notified when the modem is disconnected from the line.)
  - a. The user's telephone number
  - b. The modem's FCC registration number (printed on title page)
  - c. The ringer equivalence number (printed on title page)
  - d. The USOC jack required

## TABLE OF CONTENTS

### CHAPTER 1 - INTRODUCTION

Features .....	1-1
Physical Description .....	1-2
About the Manual .....	1-2

### CHAPTER 2 - INSTALLATION AND SETUP

Installation .....	2-1
Testing .....	2-2
Leased Line/Switched Network Configuration .....	2-5
Leased Line Operation .....	2-5
Dial Network Operation .....	2-5
Auto Dial Backup Operation .....	2-6
Choice of Modem Access .....	2-7
Downline Loading .....	2-7
Security .....	2-8
MI/MIC Operation .....	2-8

### CHAPTER 3 - OPERATION

Modes of Operation .....	3-1
Front Panel Switches and Indicators .....	3-2
Front Panel Switch Functions .....	3-3
Front Panel Indicator Functions .....	3-5
LED Readouts and Interpretations .....	3-6
Operating Commands .....	3-7
Change Speed .....	3-7
Retrain .....	3-7
Reset .....	3-7
Manual Answer/Manual Originate .....	3-7
Leased Line Connect .....	3-7
Downline Load .....	3-8
Security .....	3-9

### CHAPTER 4 - FRONT PANEL OPERATION

Dialing Functions .....	4-1
Manual Dialing .....	4-2
Store a Telephone Number .....	4-3
View a Stored Number .....	4-5
Stored Number Dialing .....	4-6
Redialing .....	4-7
Clear a Telephone Number .....	4-8
Software Options .....	4-9
View Option Settings .....	4-10
Change an Option Setting .....	4-11

### CHAPTER 5 - V.25 BIS DIALER

V.25 Bis Command Set .....	5-1
Dialing in V.25 Bis .....	5-2
V.25 Bis Commands and Indications .....	5-2
Synchronous Formats .....	5-3
Character Oriented Operation .....	5-3
Bit Oriented Operation .....	5-4

## CHAPTER 6 - TESTING

Local Analog Loopback .....	6-2
Remote Analog Loopback .....	6-3
Remote Digital Loopback .....	6-4
End-to-End Test .....	6-5

APPENDIX A - Software Options .....	A-1
APPENDIX B - Internal Jumpers .....	A-7
APPENDIX C - Telephone Line Interface .....	A-11
APPENDIX D - DTE Interface .....	A-13
APPENDIX E - Specifications .....	A-15

## TABLES

3-1 Front Panel Switch Functions .....	3-3
3-2 Front Panel Indicator Functions .....	3-5
3-3 LED Readouts and Interpretations .....	3-6
3-4 Option 26 and Modem Access .....	3-8
4-1 Option Settings .....	4-10
5-1 V.25 Bis Commands and Indications .....	5-2
5-2 V.25 Bis Parameter Alphabet .....	5-3
A-1 Option Settings .....	A-1

## FIGURES

2-1 AJ 9631-S Rear Panel .....	2-1
2-2 AJ 9631-S Dial Network Connections .....	2-2
2-3 AJ 9631-S Leased Line Connections .....	2-3
2-4 AJ 9631-S Leased Line/Dial Network Connections .....	2-4
3-1 AJ 9631-S Front Panel .....	3-1
B-1 PC Boards - Jumper Locations .....	A-8
B-2 Jumper Position Selections .....	A-9

## CHAPTER 1 INTRODUCTION

The AJ 9631-S is a fully V.32 compatible synchronous, full duplex, 9600 bps modem that operates on dial-up networks with a single phone call or on 2 or 4-wire unconditioned leased lines. It provides user-selectable Trellis coded modulation which adds signal redundancy for error performance improvement. Local and remote echo cancellation and automatic adaptive equalization ensure the high quality of data transmissions. The AJ 9631-S is capable of reliable data transmissions through satellite links.

In leased line operation, the AJ 9631-S features unattended automatic single call dial back-up. Should the leased line fail, the AJ 9631-S will automatically dial a user-stored telephone number to establish a switched network connection.

The AJ 9631-S features front panel microprocessor-controlled switches for settings options and storing telephone numbers. All settings and numbers are stored in nonvolatile memory. Dialing can be initiated from the front panel or from the DTE via an integral V.25 bis synchronous auto-dialer.

The AJ 9631-SR is a rackmount version of the AJ 9631-S. The same modem card is used in the stand-alone and rackmount units; it can be removed from the stand-alone case and installed in a rack. The AJ 9631-SR fits in the AJ 9648-CC2 rack mount chassis, 6 modems per chassis. The chassis can be mounted in a standard EIA 19" rack.

Significant features of the AJ 9631-S include:

- o Full V.32 compatibility
- o Trellis coded modulation option
- o Satellite transmission capability
- o Echo cancellation (local and remote)
- o Unattended automatic switched network dial backup
- o V.25 bis synchronous dialer for computer controlled communication
- o Automatic adaptive equalizer for stable data transmission
- o Programmable options
- o EEPROM (nonvolatile memory) for telephone number and option storage
- o MI/MIC operation
- o Front panel control of option settings and dialing
- o Automatic linking with V.25 bis dialer
- o Rackmountable, 6 modems per rack chassis
- o Modem access security
- o Extensive user diagnostics, including loopbacks, end-to-end test and self-test
- o 4800 bps fallback speed, automatic or manual
- o Downline loading of remote modem options

## Physical Description

Eleven front panel LEDs light to indicate the status of the TD, RD, CD, DTR, RTS, CTS, and DSR signals; Trellis coding operation; signal quality; security; and operating speed. Two 7-segment LEDs indicate option numbers and settings, memory addresses, telephone numbers, received signal quality, and loopback test results. The rear panel has three RJ-45 connectors for switched network, leased line and telephone set connections, and a leased line terminal block.

## About the Manual

The remaining chapters and appendices are organized as follows:

- Chapter 2 - Installation and Setup - explains how to install the AJ 9631-S for dial network, leased line, and dial backup operation. This chapter also explains how to access the modem from the front panel and via the V.25 bis dialer, and the downline loading capability.
- Chapter 3 - Operation - describes the modes of operation and the meaning and use of the front panel controls and indicators. This chapter also explains the front panel operating commands - changing speed, retraining, resetting the modem, manual answer, and downline loading - and security.
- Chapter 4 - Front Panel Operation - explains how to set up the modem for dialing (storing, viewing, and clearing telephone numbers), how to dial from the front panel, and how to view and change option settings.
- Chapter 5 - V.25 bis Dialer - describes the V.25 bis command set and how to use the V.25 bis auto dialer.
- Chapter 6 - Testing - explains how to run diagnostic tests from the front panel.
- Appendices - There are four appendices. These present definitions of the programmable options and settings, define the telephone line interface and the DTE interface, and list the technical specifications of the AJ 9631-S.



## CHAPTER 2 - INSTALLATION AND SETUP

This chapter explains how to install the AJ 9631-S modem and set up a communication network. An overview of the modem is presented to enable you to take best advantage of its valuable features. Procedures for testing and configuration are detailed in later chapters.

After installing the modem, you should consider:

- Testing of individual units
- System setup and testing
- Choice of modem access - front panel, V.25 bis DTE menu
- Modem configuration (option setting)

Information on these topics can be found following the installation section in this chapter.

### INSTALLATION

Before installing an AJ 9631-S modem, have the telephone company install the necessary lines:

- \* A 4-wire OR 2-wire unconditioned voice-grade leased line and/or
- \* A voice-grade line with RJ-45 connectors

NOTES: RJ-11C connectors may be used, but performance may be degraded.

Direct-connect modems such as the AJ 9631-S may be unable to work with the "local" line of a PBX or PABX. For better performance, a separate business telephone line should be installed.

To install the AJ 9631-S stand-alone modem, place the modem on a sturdy, convenient surface within reach of an AC power outlet, telephone line connections, and the DTE. Follow the steps below.

1. Connect the modem to the DTE by attaching an RS-232-C cable to the DTE and to the female RS-232-C port on the rear of the AJ 9631-S. (Maximum cable length = 50 feet.) The rear panel of the AJ 9631-S is illustrated in Figure 2-1.

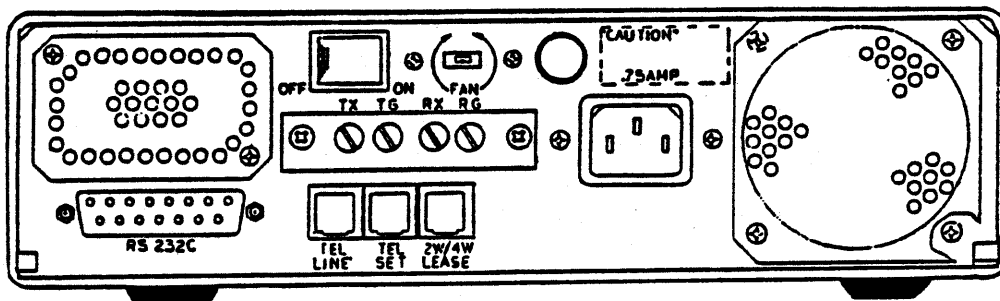

Figure 2-1 AJ 9631-S Rear Panel

2. Plug the power cord into a grounded outlet and press the ON/OFF switch on the rear panel to power up the modem.
  - \* The Data Terminal Ready (DTR) and Request to Send (RTS) indicators should light. If either indicator does not come on you must force it on within the modem. DTR Control and RTS Control are soft-strap options 1 and 2, respectively. Option descriptions and instructions for changing the settings are in Chapter 4.
3. Connect the modem to the telephone lines. The method to follow will depend on the type of cable and line terminators you are using. See Figure 2-2 for switched network connections and Figure 2-3 for leased line connections.

NOTE: For a leased line connection, be sure to connect TX to RX and TG to RG at opposite ends, or the modems cannot communicate.

To utilize the auto-dial backup feature for leased line operation, connect the modem to the dial up lines in addition to making the leased line connection. See Figure 2-4.

The same procedure should be followed to install the AJ 9631-S at the other end of the connection. You should check the front panel displays at both ends of the connection to make sure that the modems are installed correctly.

- \* Leased line operation: If the CD lights do not turn on after both modems are connected to the line and powered up, swap TX with RX, and TG with RG at one modem only and power up the modems again.
- \* Manual dialing: A telephone set can be used to dial calls manually. Connect the telephone handset to the telephone jack labeled TEL SET on the modem's rear panel. Manual dialing is useful when a call must go through a switchboard at the answering end or if problems in making a connection make it necessary to monitor a call.

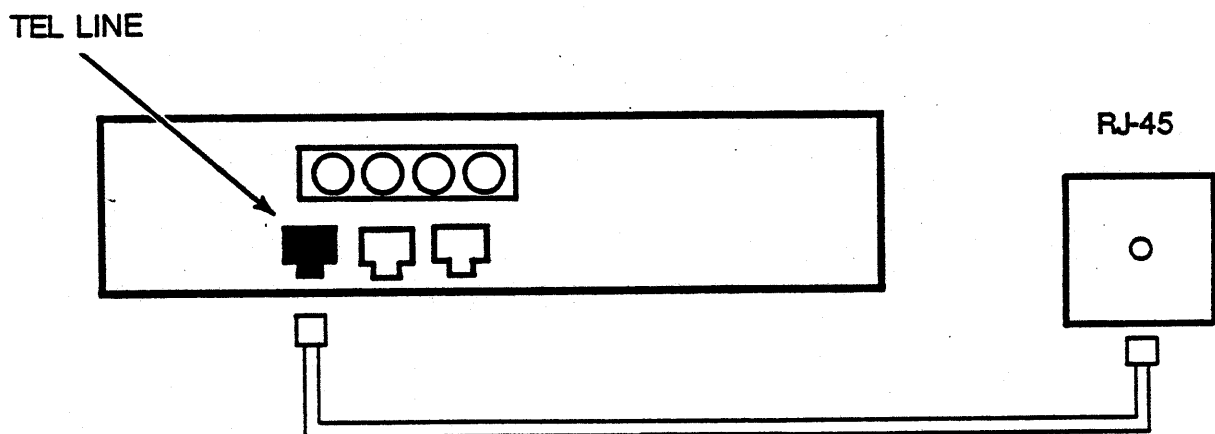
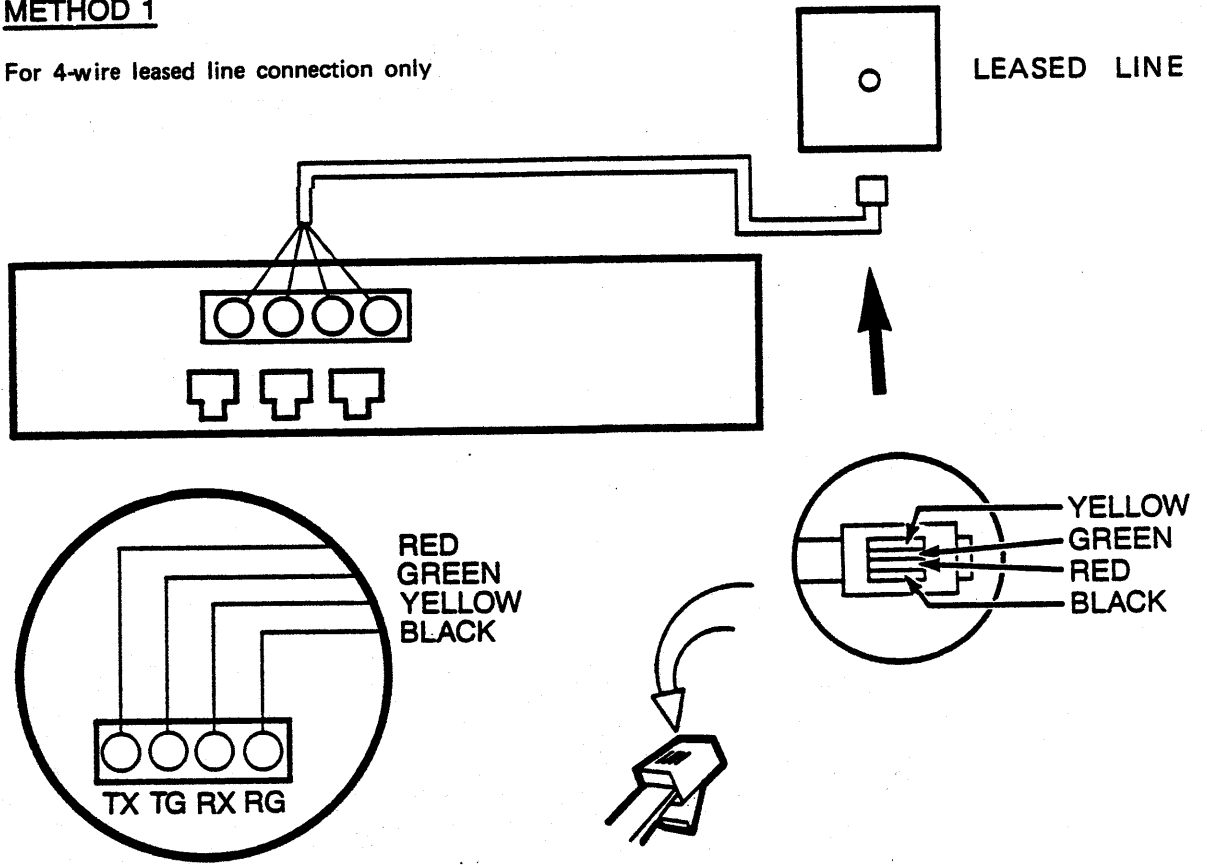

Figure 2-2 AJ 9631-S Dial Network Connection

**METHOD 1**

For 4-wire leased line connection only



**METHOD 2**

For 4-wire or 2-wire leased line connection

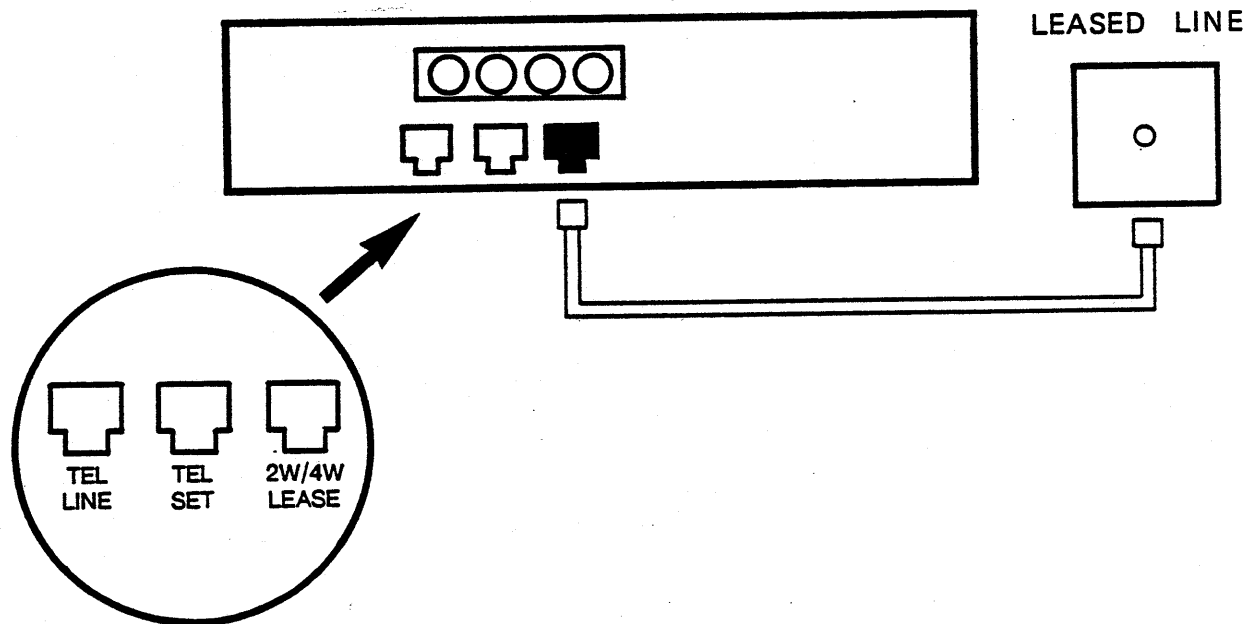
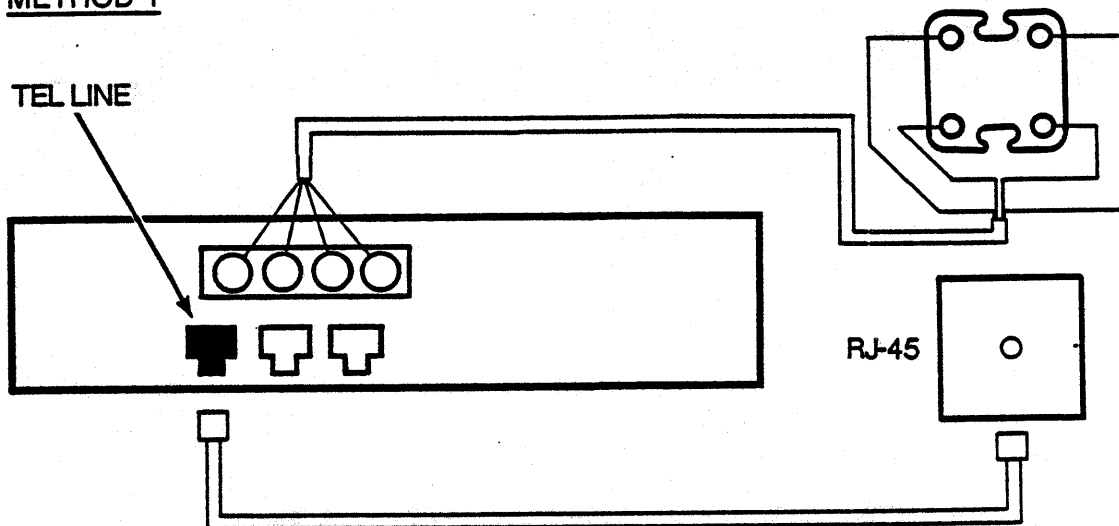

Figure 2-3 AJ 9631-S Leased Line Connections

**METHOD 1**



**NOTE: USE CONNECTION METHOD 1 OR 2 DEPENDING ON THE CABLES AND LINE TERMINATORS AVAILABLE ON SITE.**

**METHOD 2**

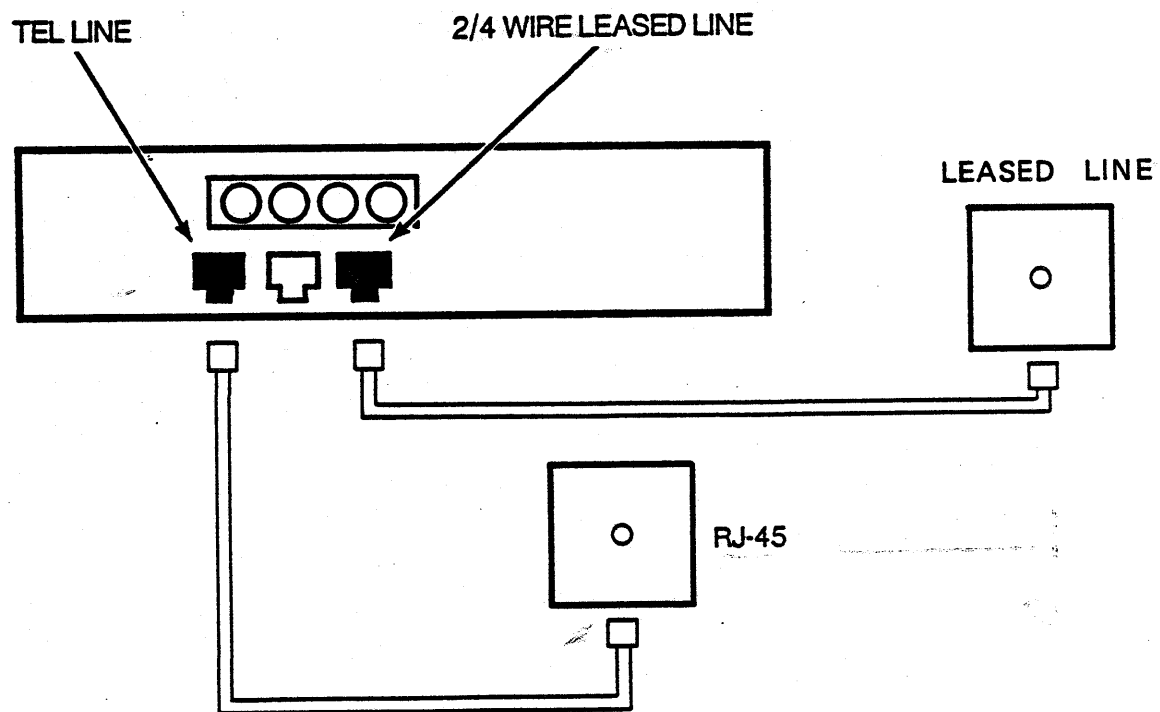

Figure 2-4 AJ 9631-S Leased Line/Dial Network Connections

## TESTING

Since data communication using AJ 9631-S modems requires 2 modems and relies on the telephone network, each modem should be tested as the system is set up. If desired, you can hook up the modems back to back to check their operation. All testing procedures are explained in Chapter 6.

- Use Local Analog Loopback (LAL) to test the local modem and the RS-232-C connection. Use the self-test version of LAL to test just the modem.
- After the modem at each end of the network is installed, run Remote Digital Loopback (RDL), Remote Analog Loopback (RAL), and End-to-End test (E/E) from one end to test the operation of the entire communication network. These loopback tests should be run over the leased lines and the switched network if both are being utilized.

NOTE: The RAL test is for 4-wire leased line configurations only.

## LEASED LINE/SWITCHED NETWORK CONFIGURATION

Setting up modems for leased line or switched network operation involves more than just connecting the modems to the telephone lines. Certain programmable options must be set correctly for the type of network operation being used. The factory default settings will be appropriate for many applications; however, you should look over the option definitions and settings (Appendix A) to be sure that the options are set correctly for your application. Refer to Chapter 4 for instructions on changing option settings.

### Leased Line Operation

Check the setting of option 8 (2/4-Wire Leased Line); the factory setting is for a 4-wire leased line.

Option 12 (Dial/ans Operation) must be set correctly for leased line or dial network, and for answer or originate operation within each modem. One modem must be set for Leased line/answer, and the other for Leased line/originate.

### Dial Network Operation

Check the setting of option 12 (Dial/ans Operation). Both modems must be set for Dial network operation; be sure that the answering modem is correctly set for manual or automatic answer.

Consider, also, the setting of option 11 (Dial Mode Transmit Level). This option allows the RJ-45 jacks to control the transmit level.

## Automatic Dial Backup Operation

To take advantage of the switched network automatic dial backup feature, dial backup must be enabled in both the local and remote modems with option 9 (Auto Dial Backup). To select dial backup operation with or without intelligent lookback, option 9 must be set the same in both modems. Setting 2 enables dial backup without lookback; setting 3 enables dial backup with intelligent lookback. See the description of the lookback feature below.

**Dial Backup:** If the leased line fails, or signal quality falls below 5, the modem set for Leased line/originate will initiate switched network backup operation. The appropriate dial backup telephone number must be stored in the first memory location (address 0) in the originating modem. See Chapter 4 for instructions on storing telephone numbers from the front panel, and Chapter 5 for instructions on storing numbers from the DTE using the V.25 bis dialer.

During leased line operation, neither modem will respond to a switched network call if the leased line connection is satisfactory, preventing unwanted calls from disturbing an established data link.

**Intelligent Lookback:** Option 10 can be set in both modems so that the modems will attempt to reconnect on the leased line every 15, 30, 60, or 120 minutes after a dial network connection is established. If a good signal is detected, the modems will return to leased line operation; otherwise, they will retain the switched network connection. The local and remote modems must be set to the same lookback period.

The modems will not drop the switched network connection when checking or reconnecting on the leased line until after successful reconnection on the leased line. Automatic lookback reduces the cost of dial-up calls by reconnecting on the leased line automatically when the leased line is restored; no operator intervention is required to initiate the switch.

**NOTE:** For the dial backup procedure to operate properly, options 9 and 10 (Auto Dial Backup and Lookback Delay) must be set the same in the local and remote modems.

## CHOICE OF MODEM ACCESS

The AJ 9631-S provides a choice of methods for accessing the modem, each permitting access to a different set of modem functions. Modem operation be controlled via:

Front panel switches  
DTE with V.25 bis command set

Choose the method of access based on the functions you need to perform. The extent of access provided by each method is described below. The front panel switches can always be used. The modem is sent from the factory with the serial auto dialer disabled; to select the V.25 bis menu to control the modem from the DTE, set option 23 (DTE Auto Dialer) to 2 (V.25 bis command set).

**Front Panel:** The front panel switches provide the maximum access to modem functions. From the front panel, you can perform all dialing functions (dial numbers, store numbers, list the directory), view and change option settings, and control the real time operation of the modem, including initiating loopbacks and changing modem speed.

**V.25 bis Commands:** The V.25 bis command set permits access only to the dialing functions. You cannot view or change option settings, or control the real time operation of the modem.

## DOWNLINE LOADING

To downline load option settings from one AJ 9631-S to another, set option 29 (Downline Load) to 2 (Send) in the sending unit. Be sure that option 29 is set to 1 (Receive) in the other AJ 9631-S. See Chapter 4 for instructions on setting options from the front panel.

Downline loading occurs when the ST switch is pressed while the modem is online. The option settings are sent via an error detection and retransmission protocol, providing assurance that they have been correctly received.

## SECURITY

A modem access security feature protects confidential telephone numbers stored in memory and the modem configuration. Security can be enabled or disabled from the front panel or the DTE. A security LED on the front panel illuminates when a security code is required for any or all modem functions. To access the modem a user must input the correct security code using the front panel switches or enter the code at the DTE keyboard in response to a prompt from the DTE.

The setting of option 26 defines the limits of access when security is enabled. Depending on the setting of this option, modem access can be restricted so that option settings or phone numbers cannot be changed, or to disallow front panel modem access and access via the V.25 bis dialer completely. See the definition of option 26 and the section on Security at the end of Chapter 3 for instructions on setting and using security codes.

## MI/MIC Operation

The AJ 9631-S supports MI/MIC operation for telephones with MI/MIC capability. The telephone handset must be connected to the "TEL SET" jack on the modem's rear panel. Once the number has been dialed, the modem will automatically connect to the dial line when the handset is put back in the cradle.



## CHAPTER 3 - OPERATION

This chapter introduces the front panel of the AJ 9631-S and presents the operating commands that can be issued from the front panel. Sixteen membrane switches with tactile feedback and thirteen indicators control modem operation and display status. The front panel of the AJ 9631-S is shown in Figure 3-1.

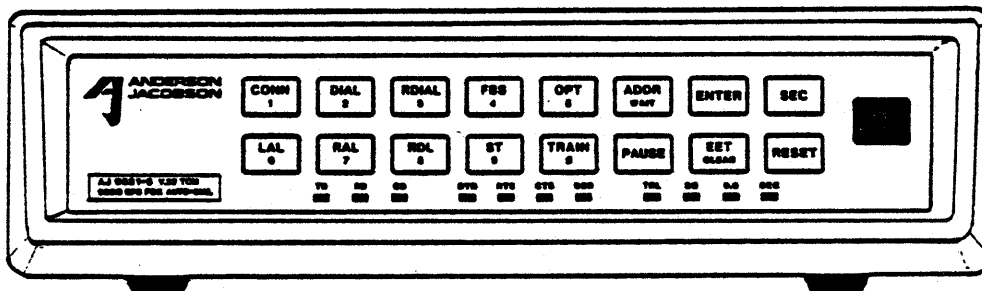

Figure 3-1 AJ 9631-S Front Panel

All modem functions--changing option settings, storing telephone numbers, dialing, running diagnostic tests, setting front panel security--can be performed using front panel switches. See Table 3-4 for a list of the modem functions that can be performed online and off-line. Dialing and storing telephone numbers can also be accomplished from the DTE via the V.25 bis auto dialer. Use of the V.25 bis dialer is explained in Chapter 5.

Most of the switches are labeled with more than one function name. These switches function differently depending on the mode of operation. The primary function name appears on top on the label; the secondary function name is beneath the primary name. Throughout the manual, only the function name relevant to the function being performed is used.

### Modes of Operation

The AJ 9631-S has 3 primary and 4 secondary modes of operation. The operating modems are entered and exited via the front panel switches or through the terminal interface. These are related as depicted in Figure 3-2. Entering a secondary mode via the front panel activates the secondary functions of the front panel switches.

The 3 primary modes are: Idle mode  
Data mode  
Test mode

#### Idle Mode

The modem is in idle mode when it is powered up but is not connected to the phone lines. From idle mode, the modem can enter data mode (if it completes a handshake with a remote unit), or you can press front panel switches to cause it to enter test mode or one of the secondary modes.

### Data Mode

Data mode is the primary operating mode. The modem is in data mode when it is connected to a phone line and CD (Carrier Detect) is on.

### Test Mode

In test mode, the modem performs diagnostic tests on itself, the remote modem, and the communication system. Enter test mode by pressing LAL, RAL, RDL, or EET on the front panel; exit test mode by pressing the same switch a second time.

-----

The 4 secondary modes are: Address  
Dial  
Option  
Security

Entering one of the secondary modes triggers the secondary functions of the other front panel switches.

### Dial Mode

In dial mode, the modem will dial a number to establish a switched network connection. Enter dial mode from idle mode by pressing DIAL to dial from the modem keyboard, or RDIAL to dial a number stored in memory. If the call is successful, the modem enters data mode; if it is unsuccessful, the modem returns to idle mode.

### Address Mode

In address mode, you can store telephone numbers in the modem's nonvolatile memory and view stored numbers. To enter address mode, press ADDR; to exit address mode, press ADDR a second time.

### Option

In option mode, you can view or change the modem's soft option settings. To enter option mode from any primary mode, press OPT. Press OPT again to exit option mode.

### Security

In security mode, you can enter a 4-digit code to set security or to disable it to access secured modem functions.

## Front Panel Switches and Indicators

The functions of the front panel switches and indicators depend on the mode of operation. The functions of the switches are outlined in Table 3-1. The functions of the front panel indicators are presented in Table 3-2.

The two 7-segment LEDs display telephone number digits, option numbers and settings, display signal quality, and present modem responses during testing. Table 3-3 presents the LED readouts and their meanings in the various modes of operation. This table is provided as a quick guide to the LED readouts. For further explanation of a display, consult the portion of the manual that deals with the function of interest.

Table 3-1 - Front Panel Switch Functions

<u>SWITCH</u>	<u>MODE</u>	<u>Function</u>
CONN 1	Idle	Establishes a connection with another dial-up modem.
	Secondary	Enters the numeral 1.
DIAL 2	Idle	Initiates dialing from the front panel; all switches operate according to their secondary function.
	Secondary	Enters the numeral 2.
RDIAL 3	Idle	Initiates dialing from memory; redials last number.
	Secondary	Enters the numeral 3.
FBS 4	Idle	Toggles the data rate between 9600 and 4800 bps.
	Data	
OPT 5	Secondary	Enters the numeral 4.
	Idle	Selects option mode; all switches operate according to their secondary function.
	Data	
Option (Setting)	Exits option mode.	
Secondary	Enters the numeral 5.	
ADDR WAIT	Idle	Selects address mode; all switches operate according to their secondary function.
	Dial Address	Enters the wait command in a telephone number.
ENTER	Secondary	Serves as a delimiter, separating commands and data entered at the front panel when used with the OPT, SEC, ADDR, DIAL, and RDIAL switches.
SEC	Idle	Selects security mode; allows entry of a security code.
	Data	

LAL 6	Idle	Initiates the Local Analog Loopback test, putting the modem into test mode.
	Secondary	Enters the numeral 6.
RAL 7	Data	Initiates the Remote Analog Loopback test, putting the modem into test mode.
	Secondary	Enters the numeral 7.
RDL 8	Data	Initiates Remote Digital Loopback test, putting the modem into test mode.
	Secondary	Enters the numeral 8.
ST 9	Data	Causes downline loading to occur.
	Test	Causes a stored test sequence to be used for the loopback tests.
	Secondary	Enters the numeral 9.
TRAIN 0	Data	Causes the modems to retrain in data mode.
	Secondary	Enters the numeral 0.
PAUSE	Dial	Causes modem to pause for 2 seconds prior to dialing next digit.
	Address	Enters the pause command in a telephone number.
EET CLR	Data	Initiates an End to End test, putting the modem into test mode.
	Address	Clears a stored telephone number.
RESET	Any mode	Causes the modem to return to idle mode.

Table 3-2 - Front Panel Indicator Functions

INDICATOR	FUNCTION
TD	Flashes as data received from DTE is sent to remote modem
RD	Flashes as data received from remote modem is sent to DTE
CD	Lights when modem detects a carrier signal
DTR	Lights when data terminal is active or signal is turned on via option 1
RTS	Lights when DTE is ready to send data or signal is turned on via option 2
CTS	Lights when modem will accept data from DTE
DSR	Lights when modem is connected to telephone line and data transfer across EIA interface is possible
TRL	Lights when modem is operating at 9600 bps with Trellis encoding.
SQ	Lights when signal quality is good. (Primary purpose is for immediate recognition of signal quality during connect attempts)
9.6	Lights when modem is operating at normal speed of 9600 bps Off when modem is operating at fallback speed of 4800 bps
SEC	Lights when a security access code is required for some or all front panel functions

Table 3-3 LED Readouts and Interpretations

Operating Mode	LED Readout	Meaning
Data-Leased Line -Dial Network	Digits (0-9) Flashing digits	Signal quality display (9 is best) SQ display; dial backup indication
Address	N: N:X	Memory address Memory address (N): telephone number digit (X)
Dial	r:N r:X	Redial (r): Memory address (N) Redial (r): digit of telephone number as modem dials (X)
Test	L L	Modem is in local analog loopback
	P:L	Modem passes LAL self test
	F:L	Modem fails LAL self test
	r A	Modem is in remote analog loopback (local modem display)
	A r	Modem is in remote analog loopback (remote modem display)
	P:A	Modem passes RAL self test
	F:A	Modem fails RAL self test
	r d	Modem is in remote digital loopback (local modem display)
	d r	Modem is in remote digital loopback (remote modem display)
	P:d	Modem passes RDL self test
	F:d	Modem fails RDL self test
	P:E	Modem passes end-to-end test
	F:E	Modem fails end-to-end test
Option	N N : N	Option number Option setting

**OPERATING COMMANDS**

<p>(1) Change Speed</p> <p>Press: <span style="border: 1px solid black; padding: 2px 10px;">FBS 4</span></p>	<p>Press FBS to change data speed from 9600 bps to 4800 bps or vice versa.</p>	<p>Option 3 (Speed/FBS Control) must be set to 1 (Indicator to DTE).</p>
<p>(2) Retrain</p> <p>Press: <span style="border: 1px solid black; padding: 2px 10px;">TRAIN</span></p>	<p>Press TRAIN to retrain both modems when in data mode.</p>	
<p>(3) Reset</p> <p>Press: <span style="border: 1px solid black; padding: 2px 10px;">RESET</span></p>	<p>Press RESET in any mode to reset the modem.</p>	<p>The current command is cleared; the modem returns to idle mode.</p>
<p>(4) Manual Answer Manual Originate</p> <p>Press: <span style="border: 1px solid black; padding: 2px 10px;">CONN 1</span></p>	<p>To manually answer a switched network call, answer the phone when it rings. Press CONN when instructed to by the caller, and hang up the phone.</p> <p>To manually originate a call, dial the desired telephone number, and press CONN to connect the modem to the line.</p>	<p>Option 12 (Dial/Ans) must be set to 2 - Dial network-manual answer.</p>
<p>NOTE: The telephone must be connected to the TEL SET jack on rear panel of both modems.</p>		
<p>(5) Leased Line Connect</p> <p>Press: <span style="border: 1px solid black; padding: 2px 10px;">CONN 1</span></p>	<p>To connect the modem to the leased line, press CONN. The modems will automatically connect 10 seconds after a reset or power up; the CONN switch allows the connection to be made more quickly.</p>	<p>Option 12 (Dial/Ans) must be set to 3, Leased line/answer, in one modem, and to 4, Leased line/originate, in the other.</p>

(6) Downline Load

Press:

ST  
9

To downline load option settings from one AJ 9631-S to another, set option 28 (Downline Load) to 2 (Send) in the sending unit. Be sure that option 28 is set to 1 (Receive) in the other AJ 9631-S.

Downline loading occurs when ST is pressed in data mode.



## SECURITY

The modem access security feature enables the network manager to restrict access to modem functions. If security is enabled, the front panel Security LED will light, and the correct security code must be entered before access is allowed. The extent of access the user has to modem operation is determined by the setting of option 26.

Table 3-4 lists the modem functions, whether each can be performed in data or idle modes (online or off-line), and which settings(s) of option 26 make them inaccessible. See option 26 in Appendix A.

NOTE: The settings of option 26 are inclusive. Therefore, if a function is locked out with setting 1, it is also locked out with settings 2 and 3.

Table 3-4 Option 26 and Modem Access

Function	Data Mode	Idle Mode	Option 26 Setting for Lockout
Downline Load	X		1,2,3
Change Options	X	X	1,2,3
Change Telephone Numbers		X	1,2,3
Tests: LAL, RDL, RAL, EET	X*	X+	2,3
ST (Self test)	Test mode	Test mode	2,3
FBS (Fallback Speed)	X	X	2,3
Reset	X	X	2,3
View Options	X	X	3
View Telephone Numbers		X	3
Dial, Redial		X	3
Connect		X	3
Retrain	X		3
V.25 bis Dialer		X	3

\* except LAL

+ LAL only

A sequence of front panel switches activates the security feature. When the security LED is lit, indicating that a security code is required, the same sequence of switches turns security off. After turning off the security LED to use the modem, a user is responsible for re-activating security and turning the security LED on again when finished using the modem.

Security commands

Set Security

PRESS:

LED DISPLAY:

<p>(1)</p> <div style="border: 1px solid black; padding: 5px; width: fit-content; margin: 0 auto;">SEC</div>	<p>SE</p>	<p>Enter security mode by pressing SEC.</p>	<p>The LEDs display 'SE'.</p>
<p>(2)</p> <p>XXXX (4-digit code)</p>	<p>S:X</p>	<p>To set a security code, enter a 4-digit code using the front panel switches.</p>	<p>The left LED displays an 'S' for security; the right LED displays the digits as they are entered.</p>
<p>(3)</p> <div style="border: 1px solid black; padding: 5px; width: fit-content; margin: 0 auto;">ENTER</div>		<p>Press ENTER to store the selected code in memory.</p>	<p>The SEC LED will light, indicating that a security code is required for some modem operations.</p>
<p>Remove Security</p> <p>PRESS:                      LED DISPLAY:</p>			
<p>(1)</p> <div style="border: 1px solid black; padding: 5px; width: fit-content; margin: 0 auto;">SEC</div>	<p>SE</p>	<p>Enter security mode by pressing SEC.</p>	<p>The LEDs display 'SE'.</p>
<p>(2)</p> <p>XXXX (4-digit code)</p>	<p>S:X</p>	<p>To remove security to access modem functions, enter the 4-digit code set previously.</p>	<p>The left LED displays an 'S' for security; the right LED displays the digits as they are entered.</p> <p>The SEC LED will turn off, indicating that no security code is required for modem operation.</p>
<p>(3)</p> <div style="border: 1px solid black; padding: 5px; width: fit-content; margin: 0 auto;">ENTER</div>		<p>Press ENTER to input the security code.</p>	

NOTE: To change the security code, follow the instructions to REMOVE security, then SET a new code.

## CHAPTER 4 - FRONT PANEL OPERATION

The switches on the front panel of the AJ 9631-S enable you to set up the modem for operation by programming software options and storing telephone numbers in memory. This chapter explains how to set options, store telephone numbers and dial from the modem's front panel.

**NOTE:** You can also store telephone numbers and dial using the V.25 bis auto dialer. Use of the dialer is covered in Chapter 5.

In these instructions, X's and N's denote digits you enter by pressing front panel switches or digits depicted on the LED. An N refers to an address (0-8) or to an option number (0-29); an X represents a telephone number digit or an option setting.

### DIALING FUNCTIONS

The AJ 9631-S enables you to dial telephone numbers in two ways-- manually, by entering each digit of the telephone number with the front panel switches, or by entering the address of a telephone number stored in memory. If you store telephone numbers in the modem's nonvolatile memory, you can dial a number by simply pressing two or three front panel switches.

This section explains how to use the front panel switches to:

- \* Dial manually
- \* Store a number in non-volatile memory
- \* View a stored number
- \* Dial a stored number
- \* Redial the last number dialed

Telephone numbers up to 43 characters long, including PAUSE and WAIT commands can be stored. The PAUSE and WAIT commands are entered with the PAUSE and WAIT switches in the same manner as the digits of the telephone number. Inserting a PAUSE in a telephone number causes the modem to pause 2 seconds before dialing the next digit. The WAIT command causes the modem to wait for a dial tone before dialing the remaining digits.

When you are storing and dialing telephone numbers, a PAUSE is displayed on the 7-segment LED by a 'P'; the WAIT command is displayed on the LED as   .

NOTE: The WAIT command can be used with tone or pulse dialing only, not with adaptive dialing; option 22 must be set to 2 or 3.

Dashes and spaces are shown in the telephone numbers in these instructions for clarity only. You cannot enter them from the front panel, nor are they displayed on the LEDs.

### MANUAL DIALING

To dial a telephone number manually, first enter DIAL mode, then enter the digits individually via the front panel switches.

The modem will begin dialing when you press ENTER.

PRESS:                      LED DISPLAY:

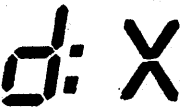
<p>(1)</p> <div style="border: 1px solid black; padding: 5px; width: fit-content; margin: 0 auto;">DIAL</div>		<p>Enter dial mode by pressing DIAL.</p>	<p>The left LED displays a 'd' and a colon.</p>
<p>(2)</p> <p>X XXX XXXXXXXX</p>		<p>Enter the digits of the telephone number, using the front panel switches.</p>	<p>The left LED displays a 'd' and a colon; the right LED displays each digit as the switch is pressed.</p>

NOTE: Any pause or wait commands entered count toward the limit of 43 characters.

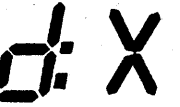
<p>(3)</p> <div style="border: 1px solid black; padding: 5px; width: fit-content; margin: 0 auto;">ENTER</div>		<p>Press ENTER to instruct the modem to begin dialing.</p>	<p>Each digit of the telephone number is displayed on the right LED as it is dialed.</p> <p>If an incorrect digit appears or to abort the call, Press RESET</p>
--	---	--	---



## STORE A TELEPHONE NUMBER

Ten telephone numbers can be stored in the modem's nonvolatile memory. To store a number you enter address mode, select an address (0-9), and press switches to enter each digit. To store another number in another memory location, you simply select a new address, and follow the same procedure to enter the digits.

Each number may contain up to 43 characters, counting PAUSE and WAIT commands.

**NOTES:** Memory location 0 is used for automatic dial backup and as a redial location. Store the number to be dialed for dial backup in leased line applications in location 0.

When the modem dials, it stores that telephone number in address 0 for subsequent redialing. You can view and edit that number just like any other number. However, when the modem dials again, the number stored in 0 will be replaced by the number dialed.

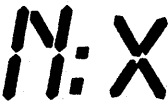
PRESS:	LED DISPLAY:		
(1) <div style="border: 1px solid black; padding: 2px; display: inline-block;">ADDR</div>		Press ADDR to enter address mode.	The left LED displays an A and a colon, indicating Address mode.
(2) <div style="border: 1px solid black; padding: 2px; display: inline-block;">N</div> (N=0-9)		Enter the address (0-9) in which a number is to be stored by pressing the appropriate front panel switch.	The left LED displays address and a colon.
(3) <div style="border: 1px solid black; padding: 2px; display: inline-block;">CLR</div>		Press CLR. Any number stored in the location is cleared, and you can enter a new number.	The LEDs display the address and a single dot. The dot indicates that nothing is stored in that location; you can enter a new number.
(4) X-XXX-XXXX		Enter the telephone number into the modem's memory by pressing the front panel switches for each digit.	The left LED displays the address; each digit of the telephone number is displayed on the right LED.

**NOTE:** If you make a mistake entering the number, press ENTER, then CLR. The modem clears the address, allowing you to re-enter the number.

(5)

ENTER

N:

After entering the last digit, press ENTER. This tells the modem that you have finished entering the number.

The modem places a delimiter after the final digit.

The LEDs display the address and a colon.

NOTE: To enter another telephone number, return to Step 2 and select a new address.  
To view the number again, press ENTER.

(6)

ADDR

To exit address mode, press ADDR.



The modem returns to idle mode.

## VIEW A STORED NUMBER

You can view a telephone number stored in memory by putting the modem into address mode, selecting an address and pressing ENTER. The modem will display the number stored at that address on the 7-segment LED, 1 digit/second. If no number is stored at the selected address, the left LED will display the address and a colon (N:), and the right LED will be blank.







You can view numbers stored in other addresses by selecting those addresses at the front panel.

**NOTE:** When the modem dials, it stores that telephone number in address 0. You can view the number stored in address 0 just like any other number. You can also edit that number, although when the modem dials again, the number you edit will be replaced by the number dialed.

PRESS	LEDs DISPLAY		
(1) <div style="border: 1px solid black; padding: 2px; display: inline-block;">ADDR</div>		Enter address mode by pressing ADDR.	The left LED displays an A and a colon, indicating address mode.
(2) <div style="border: 1px solid black; padding: 2px; display: inline-block;">N</div> (N=0-9)		Press a numbered switch on the front panel to select an address.	The LEDs display the address followed by a colon (N:).
(3) <div style="border: 1px solid black; padding: 2px; display: inline-block;">ENTER</div>		To view the number stored at the selected address, press ENTER.	The left LED displays the address followed by a colon; the right LED displays the number 1 digit/second.  If no number is stored at the address, the right LED will be blank.
<b>NOTE:</b> To view the number stored at another address, return to step 2 and select a new address.			
(4) <div style="border: 1px solid black; padding: 2px; display: inline-block;">ADDR</div>		To exit address mode, press ADDR.	The modem returns to idle mode.

## STORED NUMBER DIALING

To dial a number stored in memory, press RDIAL to enter dial mode, and select the address of the stored number. When you press ENTER, the modem will begin dialing.

PRESS	LEDs DISPLAY		
(1) 		Press RDIAL to enter stored dialing mode.	The LEDs display 'r:', indicating 'Redial'.
(2)  N = (0-9)		Press the switch for the selected address (0-9) of the stored number.	The left LED displays the selected address and a colon.
(3) 		Press ENTER to instruct the modem to dial the number at the selected address.	The right LED displays the number as the modem dials, allowing you to verify the number being dialed. The left LED displays the address.  If an incorrect digit appears, or to abort the call, press RESET.  If the call connects, the modem enters data mode. Otherwise, it returns to idle mode.





## REDIALING

There are two ways to redial a number. The modem will redial the last number dialed if RDIAL is pressed or if you dial the number stored in location 0. Numbers dialed from memory and numbers dialed manually from the front panel can be redialed.

Redialing enables you to try the call again if a successful connection was not made, or to access a system again after logging off.

### REDIAL - Method 1

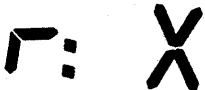
PRESS	LEDs DISPLAY		
(1) 		Press RDIAL to enter dial mode.	The left LED displays an 'r' and a colon.
(2) 		Press ENTER to dial the last number dialed.	The left LED displays r:; the right LED displays the number being dialed, 1 digit/sec.









This procedure can be repeated as often as necessary.

### REDIAL - Method 2

Follow the procedure for dialing a stored number, specifying address 0 as the address of that number. The modem dials the number stored in address 0, the last number dialed.

## CLEAR A TELEPHONE NUMBER

You can clear telephone numbers from memory individually by selecting the address and pressing the CLR switch.

PRESS	LEDs DISPLAY		
(1) 		Enter address mode by pressing ADDR.	The LEDs display an 'A' for Address mode.
(2)  (N=0-9)		Enter the address of the number you want to clear (0-9) at the front panel.	The left LED displays the selected address and a colon.
(3) 		To clear the number from memory, press CLR.	The LEDs display the address with a single dot instead of a colon indicating that the location is to be cleared.
(4) 		To execute the clear instruction, press ENTER.	The modem clears the location.
(5) 		To exit address mode, press ADDR.	The modem returns to idle mode.

## SOFTWARE OPTIONS

The AJ 9631-S features software options to configure the modem for specific system requirements. See Table 4-1 for the options and settings. You can view and change option settings using the front panel switches.

The first option, option 0, selects standard (factory set) settings. You must set this option to 2 (User-defined) before you can change other option settings. Set option 0 to 4 (Remote) at the sending modem to view or change the remote bank of option settings. All factory default settings are 1; these settings are for most standard dial-up applications.

**NOTE:** To downline load option settings, option 0 on the receiving modem must be set at 2 (user-defined). If not, the standard settings established when option 0 is set at 1 override the downline loaded settings. Set option 0 to 4 (Remote) to downline load the remote bank of options.

Table 4-1 Software Option Settings









OPTION	SETTING 1	2	3	4
0 OPTION RECALL	Factory set	User-defined	Factory Reset	Remote
1 DTR CONTROL	DTR forced on	DTR from DTE (108/1)	DTR from DTE (108/2)	*
2 RTS CONTROL	RTS forced on	RTS from DTE	*	*
3 SPEED/FBS CONTROL	Indicator to DTE	Control from DTE	*	*
4 TIMING	Internal	External	*	*
5 LAL TEST CONTROL	Disabled	From DTE	*	*
6 RDL TEST CONTROL	Disabled	From DTE	*	*
7 SQ DISPLAY	Enabled	Disabled	*	*
8 2/4-WIRE LEASED LINE	Four-wire	Two-wire	*	*
9 AUTO DIAL BACKUP	Disabled	Enabled	With lookback	*
10 LOOKBACK DELAY	15 min	30 min	60 min	120 min
11 DIAL MODE CONNECTOR	RJ-11	RJ-45	*	*
12 DIAL/ANS OPERATION	Dial/auto answer	Dial/manual answer	Leased line/answer	Leased line/orig
22 TONE/PULSE DIALING	Tone	Pulse	Adaptive	*
23 DTE AUTO DIALER	Disabled	V.25 bis command set	*	*
24 V.25 BIS PROTOCOL	Bit-synchronous	Character-synchronous	*	*
25 SPEAKER	On	Off	*	*
26 SECURITY	Store inhibit	Test inhibit	Key inhibit	*
27 TRELIS ENCODING	Enabled	Disabled	*	*
28 SPEED	9600	Auto Fallback	4800	*
29 DOWNLINE LOADING	Receive	Send	Disabled	*

**NOTE:** Options 13-21 are reserved for future enhancements.

## VIEW OPTION SETTINGS











All option settings can be viewed in sequence in option mode by observing the option number and setting displayed on the 7-segment LED.

Table 4-1, the Option Setting Chart, describes the option settings. The options and settings are described in Appendix A.

PRESS	LEDs DISPLAY		
(1) 		Enter option mode by pressing OPT on the front panel.	The LEDs display the letters OP.
(2)  (N is a 1- or 2-digit option number.)		Press the number of the option to be viewed.	The LEDs display the option number.
(3) 		Press ENTER to view the option setting.  To view the other option settings in sequence, press ENTER once to access the next option.	The left LED displays colon; the right LED displays the option setting.
-----		NOTE: An "r" will be displayed left of the setting when remote option settings are selected (option 0 is set to 4).	
(4) 		Press OPTION to exit option mode when an option setting is being displayed.	The modem returns to previous mode.  NOTE: To exit option mode, the modem must be displaying an option setting, not an option number, i.e. a colon and a digit must be displayed on the LEDs. If a colon is not displayed on the left LED, press ENTER to access the setting, then press OPT to exit option mode.

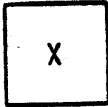
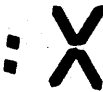
## CHANGE AN OPTION SETTING

To change the setting of an option after viewing it, enter the new setting with the front panel switches.

PRESS	LEDs DISPLAY		
(1) 		Enter option mode by pressing OPT on the front panel.	The LEDs display the letters OP.
(2)  (N is a 1 or 2 digit option number.)		Press the number of the option to be changed.	The LEDs display the option number.
(3) 		Press ENTER to view the option setting.	The left LED displays a colon; the right LED displays the option setting.
(4)  (new option setting)		To change the option setting, enter the number of the new setting.	The LEDs display a colon and the new setting.
(5) 		Press ENTER to store the new setting.	The LEDs display the next option number.
(6) 		Press ENTER to view the option setting.	The left LED displays a colon; the right LED displays the option setting.

The modem displays each option number and setting in sequence as ENTER is pressed repeatedly.

**NOTE:** An option number is always displayed without a colon; the setting of an option is preceded by a colon. An "r" will be displayed next to the colon when remote options are selected.

(7)

OPT

Press OPT to exit option mode when an option setting is being displayed.

The modem returns to the previous mode.

NOTE: To exit option mode, the modem must be displaying an option setting, not an option number, i.e. a colon and a digit must be displayed on the LEDs. If a colon is not displayed on the left LED, press ENTER to access the setting, then press OPT to exit option mode.

## CHAPTER 5 - V.25 BIS DIALER

The AJ 9631-S provides an auto dialer and a V.25 bis command set, allowing control of dialing and storing numbers from the DTE. The V.25 bis command set can be used with a synchronous terminal, facilitating computer controlled communications.

When dialing or storing numbers from the DTE, allowable characters for phone numbers are: the digits 0-9

P - two second pause

: - wait for dial tone (not available if option 22 - Tone/Pulse Dialing is set to Adaptive dialing - setting 3.)

\* and # (DTMF tones)

### V.25 Bis Command Set

To use the V.25 bis command set, first set option 23 (DTE Auto Dialer) for V.25 bis - setting 2, and set option 24 (V.25 bis Protocol) appropriately for the DTE. Follow the instructions in Chapter 4 to change these option settings from the modem's front panel.

NOTE: If security is on, V.25 bis dialing is not permitted.

Table 5-1 presents the V.25 bis commands supported by the AJ 9631-S. The command set specified in Table 3 of the CCITT V.25 bis recommendation is supported with the exception of commands dealing with double dial-up, indentifying station, and forbidden calls.

One command not in the CCITT V.25 bis recommendation is supported by the AJ 9631-S. The Link Dialing command enables numbers in the auto dial directory to be linked; it is explained below.

**Link Dialing:** LNK A1;A2;A3;... (where A1;A2;A3;... are modem addresses)  
The LNK command provides the modem with a list of up to 8 alternative phone numbers to dial should a successful connection not be made with the first number called. Each number in the link list is dialed in order until a connection is established. If no phone number leads to a successful connection, the modem will discontinue dialing after dialing each number in the list once.

NOTE: An address can be repeated in the list--the command:

LNK 1;2;1;1;1;1;1;1

will cause the modem to dial the number at address 2 if the first call is not successful, and then to try the number at address 1 until a successful connection is made, up to six more times.

A V.25 bis DTE session is completed when one of the following occurs:

- \* A successful dial connection is made and the modem enters data mode
- \* Option 23 is set back to 1 (Auto dialer Disabled)

## Dialing in V.25 Bis

The V.25 bis autodialer provides two ways to dial a telephone number-- a V.25 bis Call Request command or raising the DTR signal at the DTE interface. Table 5-1 presents the V.25 bis Commands and Indications; Table 5-2 lists allowable parameters.

To dial by raising DTR, first set option 1 (DTR Control) to 2, defining DTR to function as V.24 circuit 108/1. When the DTE raises DTR, the modem dials the telephone number stored in memory location 0. To monitor call progress, look at pin 6 on the DTE interface - CD (Carrier Detect). The modem will bring CD high when a connection is made and handshaking with the remote modem is complete.

Table 5-1 - V.25 bis Commands and Indications

COMMAND	PARAMETER FORMAT
Call Request with: Number provided Memory Address	CRN DD...D (Digits to be dialed) CRS A (Memory Address)
Program Normal	PRN A;DD...D (Memory address; digits to be dialed)
List Request of: Stored Numbers	RLN A (for one number A) or RLN (for all numbers)
Disregard Incoming Call	DIC
Connect Incoming	CIC
*Link Dialing	LNK A1;A2;A3... (Memory Addresses in order to be dialed)
INDICATION	PARAMETER FORMAT
List of: Stored Numbers	LSN A;DD...D;A;DD..D;... (Memory address; number to be dialed; ...)
Call Failure Indication	CFI YY (+)
Incoming Call	INC
Valid	VAL
Invalid	INV

\* AJ enhancements to V.25 bis

+ See Table 5-2 for the parameter list.



Table 5-2 V.25 Bis Parameter Alphabet

Parameter	IA5 Coding
0	0
1	1
2	2
3	3
4	4
5	5
6	6
7	7
8	8
9	9
Wait tone	:
Engaged tone	ET
Number not stored	NS
Local DCE busy	CB
Ring tone	RT
Abort call	AB
Answer tone not detected	NT
Parameter delimiter	;

**Synchronous Formats**

The formats for synchronous character oriented operation and bit oriented operation are given below as defined in the CCITT V.25 bis Recommendation.

Character Oriented Operation:

NOTE: Option 24 must be set to 2 - Character-synchronous protocol.

The format for synchronous character oriented operation is in accordance with ISO 1745, as shown below:

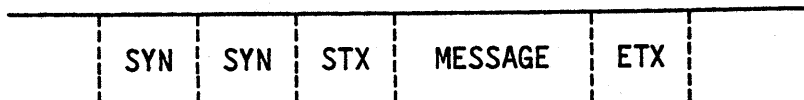

In character oriented operation, consecutive 8-bit data units are used. The 8-bit words are formed by a 7-bit IA5 (ASCII) character in accordance with Recommendation T.50 with an odd parity bit in accordance with Recommendation V.4. The bit rate is that used for data transfer.

Bit Oriented Operation:

NOTE: Option 24 must be set to 1 - Bit-synchronous protocol.

The format for synchronous bit oriented operation is HDLC (High Level Data Link Control), as shown below:



The message is the information field of a UI frame transmitted with the parity bit set to 1 and the global address. Consequently, the A and C fields are as follows:

A = 11111111 (Hex FF)  
C = 11001000 (Hex 13)

Within the message, consecutive 8-bit data units are used and submitted to the HDLC framing (zero insertion). The 8-bit words are formed by a 7-bit IA5 character in accordance with Recommendation T.50 together with an odd parity bit in accordance with Recommendation V.4. The bit rate is that used for the data transfer.

## CHAPTER 6 - TESTING

The AJ 9631-S features extensive diagnostic tests to help in troubleshooting the communication system. These tests are:

- \* LAL (Local Analog Loopback)
- \* RDL (Remote Digital Loopback)
- \* RAL (Remote Analog Loopback - 4-wire leased line operation only)
- \* EET (End-to-End Test)

NOTE: These tests can all be performed from the front panel. Only LAL and RDL can be initiated by the DTE via EIA RS-232-C interface pin 18 and pin 11.

The system should be tested during installation and thereafter, if it fails to operate properly. Run the LAL test on each modem as it is installed; then run the RDL, RAL, and EET tests from one end over the telephone lines. If the auto dial backup capability will be relied on, be sure to run the remote tests over both the leased lines and the switched network.

There are two ways to perform the loopback tests (LAL, RDL, RAL):

1. The Self-Test feature can be selected with any of these loopbacks. Test data stored in the modem will be used during the test, and the 7-segment LED on the front panel will display an indication as to the success or failure of the test. Use of the Self-Test feature is explained along with each of the tests. When the self test is initiated, a fail indication will be displayed briefly as the data synchronizes.
2. Data can be sent from the DTE through the modem and back to the DTE. In this case the DTE must determine whether the looped back data are correctly received.

To send test data from the DTE keyboard, simply type the data at the keyboard after pressing the desired test switch on the front panel, and compare the data transmitted with the data received. To exit test mode, press the same test switch again.

The RDL, RAL, and EET tests can be initiated when the modem is in data mode. When the modem exits from test mode, it returns to the operating mode it was in prior to the test. For LAL, press RESET to drop the line before pressing the LAL switch.

NOTE: In addition to initiating analog loopback, the LAL switch also busies out the telephone line. This can be important in rotary applications. If the line is not busied out, the rotary could lock onto what is perceived as an open line, and not allow the caller to make a connection. This also means that the LAL switch can be used to busy out the line when taking a modem out of service.

## LOCAL ANALOG LOOPBACK TEST

The Local Analog Loopback test is used to test the local modem and the DTE interface.

Data from the DTE or the modem are looped through the local modem's transmitter and receiver circuits and returned to the DTE (or modem) for checking.

The diagram below illustrates the local analog loopback test.

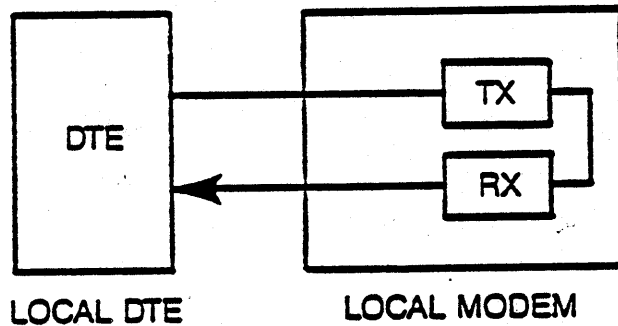

PRESS	LEDs DISPLAY		
(1) LAL 6	LL	Press LAL to begin the local analog loopback test.	The LEDs display 'LL' for Local Loopback.
(2) ST 9	P:L	Wait until the CD LED on the front panel lights, indicating that the modem has trained with itself. Then press ST to select the Self-Test feature.	The modem will transmit a continuous test pattern, and will compare the data received with the data transmitted.  The 7-segment LEDs will display P:L if the test results are good, and will display F:L if the modem fails the LAL test.
(3) LAL 6		Press LAL again to end the local analog loopback test and exit test mode.	

**REMOTE ANALOG LOOPBACK TEST**  
 (4-Wire Leased Line operation only)

The Remote Analog Loopback test is used to test the local modem, the DTE interface, and the telephone line. It can only be used in 4-wire leased line applications.

The diagram below illustrates the remote analog loopback test.

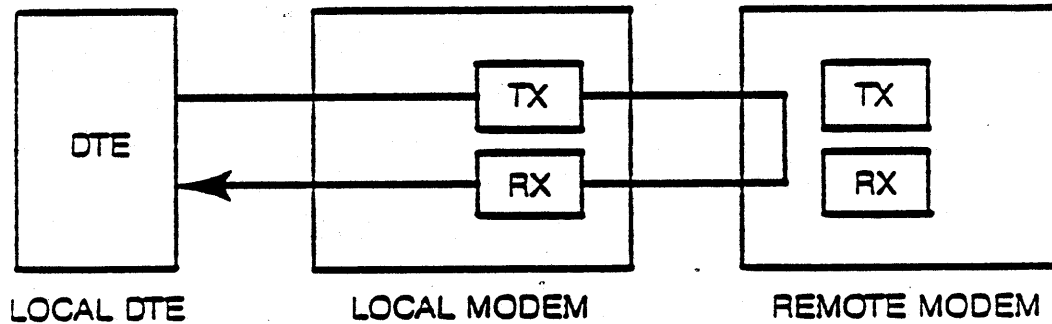

PRESS	LEDs DISPLAY		
(1) RAL 7	rA	Press RAL to begin the remote analog loopback test.	The local modem LEDs display 'rA'; the remote modem LEDs display 'Ar'.
(2) ST 9	P:A	Wait until the CD LED on the front panel lights, indicating that the modem has trained with itself. Then press ST to select the Self-Test feature.	The modem will transmit a continuous test pattern, and will compare the data received with the data transmitted.  The 7-segment LEDs will display P:A if the test results are good, and will display F:A for 1/2 second each time a bit error is detected.
(3) RAL 7		Press RAL again to end the remote analog loopback test and exit test mode.	

## REMOTE DIGITAL LOOPBACK TEST

The Remote Digital Loopback is used to test the local and remote modems, the local DTE interface, and the telephone network.

The diagram below illustrates the remote digital loopback test.

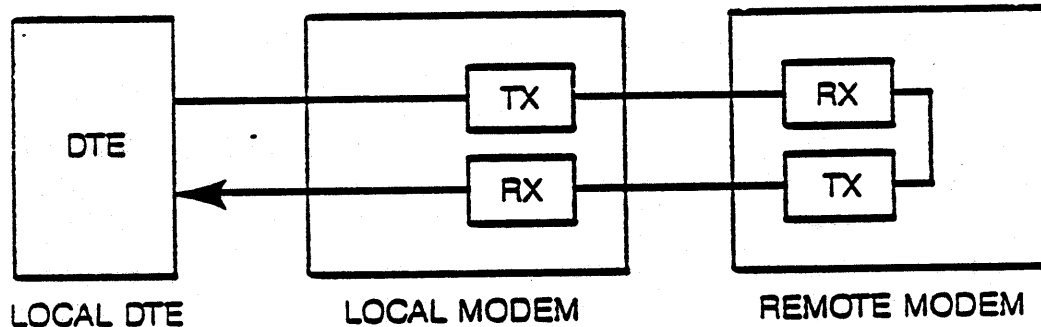

PRESS	LEDs DISPLAY		
(1) RDL 8	<i>rd</i>	Press RDL to begin the remote digital loopback test.	The remote modem LEDs display 'rd'.
(2) ST 9	<i>P:d</i>	Wait until the CD LED on the front panel lights, indicating that the modem has trained with itself. Then press ST to select the Self-Test feature.	The modem will transmit a continuous test pattern, and will compare the data received with the data transmitted.  The 7-segment LEDs will display P:d if the test results are good, and will display F:d if the modem fails the RDL test. Also, an F will be displayed for 1/2 second each time an error is detected.
(3) RDL 8		Press RDL again to end the remote digital loopback test and exit test mode.	

## END-TO-END TEST

The End-to-End test is used to test both modems, both DTE interfaces, and the telephone line.

In the End-to-End test, both modems send a test pattern to the other modem, compares the incoming signal with the test pattern sent.

The diagram below illustrates the End-to-End test.

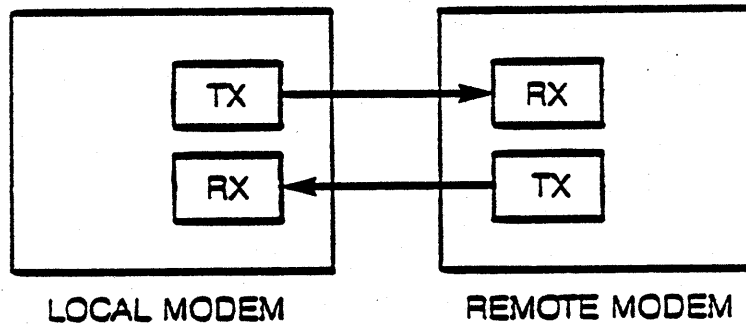

PRESS	LEDs DISPLAY		
(1) EET CLR	P:E	Press EET to initiate the End-to-End test.	The 7-segment LEDs display P:E if the local modem passes the test, and display F:E for 1/2 second each time an error is detected.
(2) EET CLR		Press EET again to end the End-to-End test and exit test mode.	





## APPENDIX A - SOFTWARE OPTIONS

The AJ 9631-S features software options that configure the modem to meet specific system requirements. The option settings can be viewed and changed via the front panel switches.

The first option, option 0, selects standard (factory set) settings. This option must be set to 2 before other local option settings can be changed. Set option 0 to 4 to view or change the remote bank of option settings.

NOTE: To downline load option settings, option 0 on the receiving modem must be set at 2 (user-defined). If not, the standard settings established when option 0 is set at 1 override the downline loaded settings. Set option 0 to 4 (Remote) at the sending modem to downline load the remote bank of option settings.

Table A-1 below presents the options and settings. The options are defined in the pages following. The modem is shipped from the factory with all options set to 1, suitable for most standard dial-up applications.

Table A-1 Software Option Settings

OPTION	SETTING 1	2	3	4
0 OPTION RECALL	Factory set	User-defined	Factory Reset	Remote
1 DTR CONTROL	DTR forced on	DTR from DTE (108/1)	DTR from DTE (108/2)	*
2 RTS CONTROL	RTS forced on	RTS from DTE	*	*
3 SPEED/FBS CONTROL	Indicator to DTE	Control from DTE	*	*
4 TIMING	Internal	External	*	*
5 LAL TEST CONTROL	Disabled	From DTE	*	*
6 RDL TEST CONTROL	Disabled	From DTE	*	*
7 SQ DISPLAY	Enabled	Disabled	*	*
8 2/4-WIRE LEASED LINE	Four-wire	Two-wire	*	*
9 AUTO DIAL BACKUP	Disabled	Enabled	With lookback	*
10 LOOKBACK DELAY	15 min	30 min	60 min	120 min
11 DIAL MODE CONNECTOR	RJ-11	RJ-45	*	*
12 DIAL/ANS OPERATION	Dial/auto answer	Dial/manual answer	Leased line/answer	Leased line/orig
22 TONE/PULSE DIALING	Tone	Pulse	Adaptive	*
23 DTE AUTO DIALER	Disabled	V.25 bis command set	*	*
24 V.25 BIS PROTOCOL	Bit-synchronous	Character-synchronous	*	*
25 SPEAKER	On	Off	*	*
26 SECURITY	Store inhibit	Test inhibit	Key inhibit	*
27 TRELLIS ENCODING	Enabled	Disabled	*	*
28 SPEED	9600	Auto Fallback	4800	*
29 DOWNLINE LOADING	Receive	Send	Disabled	*

NOTE: Options 13-21 are reserved for future enhancements.

**OPTION****DEFINITION/SETTINGS****0 OPTION RECALL**

Selects FACTORY defined option settings or settings previously set by the USER and stored in temporary memory. A third setting resets all option settings to 1 (factory settings) except option 0; option 0 is set to 2. Setting 4 enables you to view and change the remote bank of options before downline loading them.

- \* 1 Factory Set
- \* 2 User-defined
- \* 3 Factory reset
- \* 4 Remote

NOTE: If option 0 is set to 1, other option settings can be changed, but the settings will not be effective. To activate the new settings, set option 0 to 2. If option 0 = 2, the new option settings become active immediately when they are changed and option mode is exited.

**1 DTR CONTROL**

Data Terminal Ready signal controlled by the DTE via pin 20 as defined by the setting, or forced on by the modem. Setting 2 (V.24 circuit defined as 108/1) causes the modem to dial the telephone number stored in the first memory location when DTR is raised by the DTE.

- \* 1 DTR forced on
- \* 2 DTR controlled by DTE according to V.24 circuit 108/1
- \* 3 DTR controlled by DTE according to RS-232-C circuit CD or V.24 circuit 108/2

**2 RTS CONTROL**

Request To Send signal forced on by the modem or controlled by the DTE .

- \* 1 RTS forced on
- \* 2 RTS from DTE

**3 SPEED/FBS CONTROL**

Determines use of pin 23 of the RS-232C interface--SPEED INDICATOR to the DTE or SPEED CONTROL from the DTE. This option also determines whether the modem will accept a fallback speed command from the front panel or the DTE when pin 23 of the RS-232-C interface is held low.

- \* 1 Speed indicator to DTE/Front panel control of FBS
- \* 2 Speed control from DTE/DTE control of FBS

- 4 TIMING Determines whether the modem's transmit timing is controlled by the DTE via pin 24 (EXTERNAL) or by the modem (INTERNAL).
- \* 1 Internal
  - \* 2 External
- 5 LAL TEST CONTROL Allows the DTE to initiate the LAL test via pin 18 of the RS-232C interface.
- \* 1 Disabled
  - \* 2 From DTE (pin 18)
- 6 RDL TEST CONTROL Allows the DTE to initiate an RDL test via pin 11 of the RS-232-C interface.
- \* 1 Disabled
  - \* 2 Enabled from DTE (pin 11)
- 7 SIGNAL QUALITY DISPLAY/DIAL BACKUP INDICATOR Allows the modem to display a decimal signal quality reference level on the front panel LEDs during normal operation.
- When the modem goes into dial backup operation, the SQ display flashes 1/2 second on, 1/2 second off, as an indication to the operator that the modem is operating on the dial network. If the automatic dial backup feature will be used, this Signal Quality Display option should be enabled, since the flashing display is the only warning that the modem has gone into dial backup operation.
- \* 1 Enabled
  - \* 2 Disabled
- 8 TWO/FOUR WIRE LEASED LINE SELECT Allows the modem to utilize a two wire leased line or a four wire leased line.
- \* 1 Four-wire
  - \* 2 Two-wire

- 9 AUTOMATIC DIAL BACKUP Allows the modem to automatically dial to restore the connection via the switched network when CD is not present on the leased line. Additionally, this option can be set to enable automatic lookback. When lookback is enabled, the modem will periodically monitor the leased line, and reconnect on the leased line if signal quality is good. The modem does not drop the dial connection until after a successful leased line connection is made. The lookback delay can be selected in option 10.
- \* 1 Disabled
  - \* 2 Enabled
  - \* 3 Enabled with lookback
- NOTE: To enable dial backup or dial backup with lookback, option 9 must be set to the same setting in both modems.
- 10 LOOKBACK DELAY Selects the lookback delay for dial backup operation. Depending on the setting selected, the modem will look back at the leased line every 15, 30, 60 or 120 minutes while operating on the dial network, reconnecting on the leased line if signal quality is acceptable, retaining the dial network connection if it is not.
- NOTE: If lookback is enabled, both the local and remote modems must be set for the same lookback delay.
- 11 DIAL MODE CONNECTOR Allows the dial mode transmit level to be controlled by the programming resistor, by means of an RJ-45 jack. (During leased line operation, internal switch settings determine the transmit level.)
- \* 1 -10 dBm +/- 1 dB (for RJ-11)
  - \* 2 Set by programming resistor (for RJ-45)
- 12 DIAL/ANSWER OPERATION Determines the leased line or dial network mode of operation.
- \* 1 Dial/auto answer
  - \* 2 Dial/manual answer
  - \* 3 Leased line/answer
  - \* 4 Leased line/originate
- 22 TONE/PULSE DIALING Establishes tone or pulse dialing, or enables the modem to attempt tone dialing, reverting to pulse dialing if necessary.
- \* 1 Tone
  - \* 2 Pulse
  - \* 3 Adaptive

- 23 AUTO DIAL INTERFACE Enables or disables the serial auto dialer with the V.25 bis command set
- \* 1 Disabled
  - \* 2 V.25 bis command set
- 24 V.25 BIS PROTOCOL Selects the V.25 bis protocol for character-synchronous or bit-synchronous data, if option 23 selects the V.25 bis command set (setting 2). The modem will scroll over this option in the front panel selection display, if option 23 is not set at 2.
- \* 1 Bit-synchronous
  - \* 2 Character-synchronous
- 25 SPEAKER Controls operation of the speaker. In leased line operation the speaker provides an audible alarm during dial backup; in switched network operation, the speaker allows call progress monitoring. The speaker also provides audible feedback when a switch is pressed.
- \* 1 ON
  - \* 2 OFF
- 26 SECURITY Establishes limits of access to modem operations. This option can be set to restrict access to modem functions. See Table 3-4 for the specific modem functions locked out by these option settings.
- \* 1 No option setting changes or phone number storage
  - \* 2 No option setting changes, phone number storage, tests, or RESET
  - \* 3 No front panel access; no access via V.25 bis dialer
- 27 TRELIS ENCODING Enables or disables Trellis coded modulation. When disabled, modulation is standard 16 point modulation as defined in V.32.
- \* 1 Enabled
  - \* 2 Disabled
- 28 SPEED When enabled, the modem will fallback to 4800 bps, should SQ fall below 5 for 5 seconds.
- \* 1 9600 bps
  - \* 2 Enabled
  - \* 3 4800 bps

29 DOWNLINE  
LOADING

Allows software option settings to be downline loaded from one 9631-S to another. One modem must be set to send and the other must be set to receive. NOTE: The setting of option 12 (Dial/Answer Operation) is sent as follows: If option 12 in the sending unit is set to 1 or 2, the same setting is sent; if option 12 in the sending unit is set for 3, setting 4 is sent; if option 12 is set to 4, setting 3 is sent.

- \* 1 Receive
- \* 2 Send
- \* 3 Disabled

NOTE: If option 0 is set to 4, the remote bank of options can be changed, then downline loaded. The local configuration is not affected.

## APPENDIX B - INTERNAL JUMPERS

Internal jumpers on the PC boards control the leased line transmit level and the signal for the eye pattern generator. To access the PC boards, remove the four screws from the bottom of the case and slide the modem out of the case.

The jumper to select the leased line transmit level (J16A) is located on the top PC board. The jumpers that control the eye pattern generator signal (J18 and J19) are located on the bottom PC board. See Figure B-1 for the locations of the jumpers. See Figure B-2 for the jumper position selections.

### Eye Pattern Generator

For the eye pattern generator, moving both jumpers J18 and J19 towards the inside of the PC card keeps the eye pattern generator signal inside the modem. Moving the jumpers to the outside position allows the signal out to pins 12 and 13 on the RS-232-C connector. Using needle-nosed pliers will enable you to move the J18 and J19 jumpers from the side of the modem without removing the top boards.

You can also use an eye pattern generator by hooking the oscilloscope probes directly to the ends of the resistors next to jumpers J18 and J19, regardless of the positions of the jumpers.

### Leased Line Transmit Level

The jumpers to select the leased line transmit level are on the top board. The transmit level settings are silk-screened on the board.

Depending on the rev level of your board, the silk-screened settings will be:

-9, 0, and -16,  
or  
-10, -1, and -16.

The actual settings are -10, -1, and -16 dBm +/-1 dB. Select the desired transmit level by positioning the jumper as shown in Figure B-2.

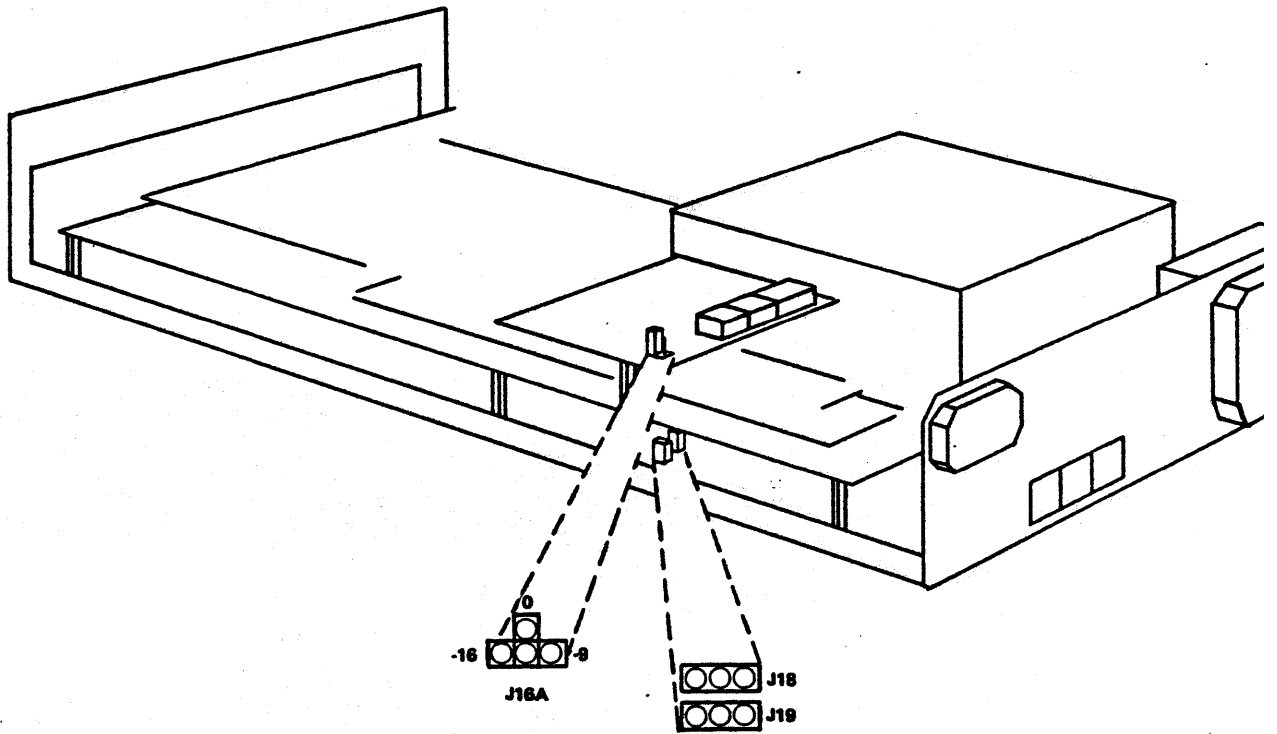

Figure B-1 PC Boards - Jumper Locations



Jumper	Position	Selection
<p>J18, J19</p>		<p>Keeps signal for eye pattern generator within modem.</p> <p>Allows signal for eye pattern generator out to pins 12 and 13 of the RS-232-C interface.</p>
<p>J16A</p>		<p>-10 dBm +/-1 dB</p> <p>-1 dBm +/-1 dB</p> <p>-16 dBm +/-1 dB</p>

Figure B-2 Jumper Position Selections



## APPENDIX C TELEPHONE LINE INTERFACE

There are three telephone line connectors on the rear panel labeled TEL LINE, TEL SET and 2W/4W LEASED. The modular line connector pins for these connectors are shown in Table C-1 below. Note that the table indicates two pins each for TX, TG, RX, and RG. Which pins to use for those functions will depend on the type of wall plug you connect to.

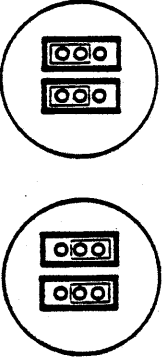
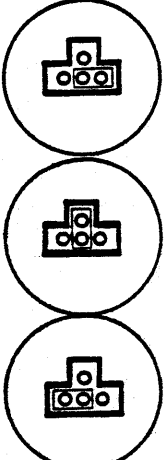
NOTE: Pins with the same function are shorted together within the modem so if you have a new type (pins 1,2,7,8 active) or old type (pins 3,4,5,6 active) you can use the modular connectors without any problem. Pins 3, 4, 5, and 6 are internally connected to pins 7, 1, 2, and 8, respectively.

Table C-1 Modular Line Connector Pins

DATA JACK PIN #	2/4-Wire Leased line	Standard Wire Color
1	TX	Blue
2	TG	Orange
3	RX	Yellow
4	TX	Red
5	TG	Green
6	RG	Black
7	RX	Brown
8	RG	Slate

Table C-2 shows the standard (old) and alternate (new) wire colors for attachment to the terminal block connector on the rear of the modem and the terminating block wall plug.

Table C-2 Leased Line Terminal Block Pins

Modem Connector	Standard Wire Color	Alternate Wire Color
TX	Red	Blue
TG	Green	Orange
RX	Yellow	Brown
RG	Black	Slate



APPENDIX D DTE INTERFACE

Pin #	EIA Circuit Designator	Anderson Jacobson Designator	Function	Active State
1	AA	FG	Protective Ground	G
2	BA	TD	Transmitted Data	E
3	BB	RD	Received Data	E
4	CA	RTS (1)	Request-To-Send	H
5	CB	CTS	Clear-To-Send	H
6	CC	DSR	Data Set Ready	H
7	AB	-	Signal Ground (Common Return)	G
8	CF	CD	Carrier Detect (Rcv'd Line Sig. Det.)	H
9	+12			
10	-12			
11		RDL	Remote Digital Loopback	H
12		EYE X		
13		EYE Y		
15	DB	TC	Transmitter Clock (DCE Source)	E
17	DD	RC	Receiver Clock (DCE Source)	E
18	SCA	LAL	Local Analog Loopback (DTE Source)	H
20	CD	DTR (1) Ready	Data Terminal Ready	H
22	CE	RI	Ring Indicator	H
23	CH/CI	-	Data Rate Selector (DCE or DTE Source)	H
24	DA	-	External Transmitter Clock	E
25		T1	Test Indicator	H

Data Terminal Equipment (DTE)      Data Communications Equipment (DCE)

\*G = Ground or Common Reference      H = Logic High  
 E = Either State Active Or Data Stream      T = Test Signal  
 1 = Signals From DTE To Modem Required For Modem Operation



## APPENDIX E - SPECIFICATIONS

Input Data Format -	Serial binary, synchronous.
Data Rates -	9600, 4800 bps.
Operating Mode -	Full duplex on standard 2-wire dial-up lines or on 2 or 4-wire 3002 unconditioned leased lines.
Transmission Modulation -	V.32, 4800 bps - 2 x 2 QAM 9600 bps - 4 x 4 QAM or 32 vector Trellis coding
Transmitter Carrier Frequency -	1800 Hz +/- 1 Hz.
Transmit Level -	-10.0 dBm +/- 1.0 dB, permissive mode, or RJ-45 on the dial network; -1, -10, -16 dBm +/- 1.0 dB on leased lines.
Receiver Carrier Frequency -	1800 Hz +/- 1 Hz.
Receiver Sensitivity -	-43 dBm.
Terminal Interface -	RS-232-C, V.24.
Loss of Carrier -	Leased line to auto dial operation - 20 sec Dial mode to disconnect - 10 sec.
Environmental Data -	
Operating temperature range:	0° - 50° C (32° - 122° F).
Storage temperature range:	-20° - 60° C (-4° - 140° F).
Relative humidity:	10 - 90% (non-condensing).
Power Requirements -	115 Vac and 230 Vac +10%/-15%; 47-63 Hz;
Power Consumption -	85 watts, maximum
Dimensions -	10" x 16 1/2 " x 2 3/4 ".







We hope you found this publication easy to understand and useful.

You can help us to maintain quality standards by your response to the following questions. Your comments and suggestions will be appreciated. If you have a question and want a reply, be sure to include your name and complete mailing address. Thank you.

1. Does this manual meet your needs? Yes  No   
If not, what additional information would help you?  
Comments:
  
2. Can you find what you're looking for quickly and easily? Yes  No   
How can the organization be improved?  
Comments:
  
3. Is the material easy to read and to understand? Yes  No   
Comments:
  
4. Are there enough illustrations to support the text? Yes  No   
Comments:
  
5. Did you find any errors or ambiguities in the manual? Yes  No   
If yes, please cite page, line and/or figure number with  
your comments.
  
6. Other comments:

7. What is your relationship to the product described in this manual?

Operator

Systems supervisor/manager

Communications supervisor/  
manager

Other (please specify)



----- FOLD AND SEAL HERE -----

----- FOLD HERE -----

ATTN: Publications Manager



NO POSTAGE  
NECESSARY  
IF MAILED  
IN THE  
UNITED STATES

**BUSINESS REPLY MAIL**

FIRST CLASS PERMIT NO. 6177 SAN JOSE, CALIFORNIA

POSTAGE WILL BE PAID BY ADDRESSEE

**ANDERSON JACOBSON**

521 Charcot Avenue  
San Jose, California 95131

